

**WS72358B**
**Low-Power Rail-to-Rail Input Output Operational Amplifiers**
[Http://www.willsemi.com](http://www.willsemi.com)
**Descriptions**

The WS72358B series is a dual low-voltage operational amplifier with rail-to-rail input/output swing. Ultra low quiescent current makes this amplifier ideal for portable, battery operated equipment. The common mode input range includes ground making the device useful for low-side current-shunt measurements.

The WS72358B is available with MSL 3 Level in SOP-8L package and MSOP-8L package. Standard products are Pb-Free and halogen-Free.

**Applications**

- Active Filters
- Smoke/Gas Sensors
- Battery Powered Electronic Equipments
- Personal Medical Care

**Features**

- Single Supply Voltage : 1.8~5.5V
- Quiescent Current per Amplifier : 42 $\mu$ A Typical
- GBWP : 1.5MHz
- Slew Rate : 1.1V/ $\mu$ s
- Positive Offset Voltage : 0.5mV to 6.3mV
- Offset Voltage Temp. Drift : 1.1 $\mu$ V /  $^{\circ}$ C
- THD+N : -102dB@1kHz,  
-86dB@10kHz
- CMRR/PSRR : 100dB/102dB
- Output Short-Circuit Curr. : 46mA
- -40 $^{\circ}$ C to 125 $^{\circ}$ C Operation Range
- Drives 2k $\Omega$  Resistive Loads
- No Output Crossover Distortion
- No Phase Reversal from Overdriven Input
- Rail-to-Rail Input/Output Swing

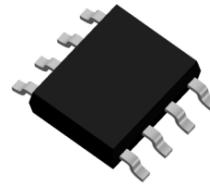
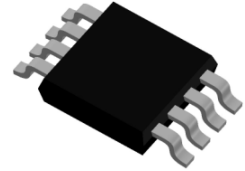
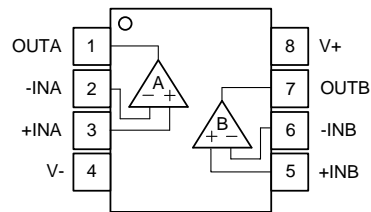
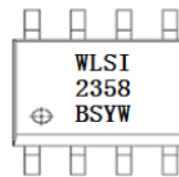
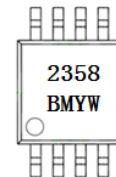
**SOP-8L**

**MSOP-8L**

**SOP-8L/MSOP-8L**
**Pin configuration (Top view)**

**SOP-8L**

**MSOP-8L**
**Marking**

- 2358** = Device code
- BS** = Special code
- BM** = Special code
- Y** = Year code
- W** = Week code

**Order Information**

Device	Package	Shipping
WS72358BS-8/TR	SOP-8L	4000/Reel &Tape
WS72358BM-8/TR	MSOP-8L	4000/Reel &Tape

**Pin Descriptions**

Pin Number	Symbol	Descriptions
1	OUTA	Output
2	-INA	Inverting input
3	+INA	Non-inverting input
4	V-	Negative supply
5	+INB	Non-inverting input
6	-INB	Inverting input
7	OUTB	Output
8	V+	Positive supply

**Absolute Maximum Ratings**

Parameter	Symbol	Value	Unit
Supply Voltage, ([V+] – [V-])	$V_S^{(2)}$	6	V
Input Differential Voltage	$V_{IDR}^{(3)}$	±6	V
Input Common Mode Voltage Range	$V_{ICR}$	(V-)-0.2 to (V+)+0.2	V
Output Short-Circuit Duration	$t_{SO}$	Unlimited	/
Operating Free-Air Temperature Range	$T_A$	-40 to 125	°C
Storage Temperature Range	$T_{STG}$	-65 to 150	°C
Junction Temperature Range	$T_J$	150	°C
Lead Temperature Range	$T_L$	260	°C

**Note:**

1. Stresses beyond those listed under Absolute Maximum Ratings may cause permanent damage to the device. These are only stress ratings, and functional operation of the device at these or any other conditions beyond those indicated under recommended operating conditions are not implied. Exposure to absolute-maximum-rated conditions for extended periods may affect device reliability.
2. All voltage values, except differential voltage are with respect to network terminal.
3. Differential voltages are at +IN with respect to -IN.

**ESD, Electrostatic Discharge Protection**

Symbol	Parameter	Condition	Minimum level	Unit
HBM	Human Body Model ESD	MIL-STD-883H Method 3015.8 JEDEC-EIA/JESD22-A114A	±8000	V
MM	Machine Model ESD	JEDEC-EIA/JESD22-A115	±350	V
CDM	Charged Device Model ESD	JEDEC-EIA/JESD22-C101E	±2000	V

**Electronics Characteristics**

The \*denotes the specifications which apply over the full operating temperature range, otherwise specifications are at  $T_A = 25^\circ\text{C}$ .  $V_S = 5\text{V}$ ,  $V_{CM} = V_{OUT} = V_S/2$ ,  $R_{load} = 100\text{k}\Omega$ ,  $C_{load} = 100\text{pF}$ .

Symbol	Parameter	Conditions	Min.	Typ.	Max.	Unit	
$V_{OS}$	Input Offset Voltage	$V_{CM} = V_S/2$	*	+0.5	+3.4	+6.3	mV
$\alpha_{VOS}$	Input Offset Voltage Drift			1.1		$\mu\text{V}/^\circ\text{C}$	
$I_{IB}$	Input Bias Current			10		pA	
$I_{OS}$	Input Offset Current			10		pA	
$V_n$	Input Voltage Noise	$f=0.1\text{Hz to }10\text{Hz}$		5.2		$\mu\text{V}_{P-P}$	
		$f=10\text{Hz to }20\text{kHz}$		4.6		$\mu\text{V}_{rms}$	
$e_n$	Input Voltage Noise Density	$f=1\text{kHz}$		30		$\text{nV}/\sqrt{\text{Hz}}$	
		$f=10\text{kHz}$		23			
CMRR	Common Mode Rejection Ratio	$V_{CM}=0.1\text{V to }4.9\text{V}$	*	80	100		dB
$V_{CM}$	Common Mode Input Voltage Range		*	$(V^-)-0.2$		$(V^+)+0.2$	V
PSRR	Power Supply Rejection Ratio		*	85	102		dB
$A_{VOL}$	Open Loop Large Signal Gain	$V_{OUT}=0.1\text{V to }4.9\text{V}$ , $R_{load}=10\text{k}\Omega$	*	100	109		dB
$V_{OH}$	High Level Output Voltage	$R_{load}=2\text{k}\Omega$			50		mV
		$R_{load}=10\text{k}\Omega$			5		
$V_{OL}$	Low Level Output Voltage	$R_{load}=2\text{k}\Omega$			50		mV
		$R_{load}=10\text{k}\Omega$			5		
$I_{SC}$	Output Short-Circuit Current	Sink/Source Current			46		mA
$I_Q$	Quiescent Current per Amplifier		*		42	60	$\mu\text{A}$
PM	Phase Margin	$R_{load}=100\text{k}\Omega$ , $C_{load}=100\text{pF}$			65		degrees
GM	Gain Margin	$R_{load}=100\text{k}\Omega$ , $C_{load}=100\text{pF}$			-15		dB
GBWP	Gain-Bandwidth Product	$f=1\text{kHz}$			1.5		MHz
$t_s$	Settling Time	1.5 to 3.5V, Unity Gain			0.1%	1.9	$\mu\text{s}$
		2.45 to 2.55V, Unity Gain			0.1%	0.29	
SR	Slew Rate	$A_V=1$ , $V_{OUT}=1.5\text{V to }3.5\text{V}$ , $R_{load}=100\text{k}\Omega$ , $C_{load}=100\text{pF}$			1.1		$\text{V}/\mu\text{s}$
FPBW	Full Power Bandwidth	$2V_{P-P}$			180		kHz
THD+N	Total Harmonic Distortion and Noise	$f=1\text{kHz}$ , $A_V=1$ , $R_{load}=100\text{k}\Omega$ , $V_{OUT}=2V_{PP}$			-102		dB
		$f=10\text{kHz}$ , $A_V=1$ , $R_{load}=100\text{k}\Omega$ , $V_{OUT}=2V_{PP}$			-86		

**Note:**

1. Stresses beyond those listed under Absolute Maximum Ratings may cause permanent damage to the device. Exposure to any Absolute Maximum Rating condition for extended periods may affect device reliability and lifetime.
2. A heat sink may be required to keep the junction temperature below the absolute maximum rating when the output is shorted indefinitely.
3. Thermal resistance varies with the amount of PC board metal connected to the package. The specified values are for short traces connected to the leads.
4. Full power bandwidth is calculated from the slew rate  $FPBW = SR/(\pi \cdot V_{P-P})$ .

**Typical Characteristics**
 $T_A=25^\circ\text{C}$ ,  $V_S=\pm 2.5\text{V}$ ,  $V_{CM}=0\text{V}$ , unless otherwise noted

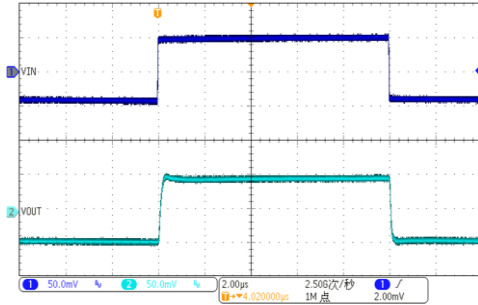
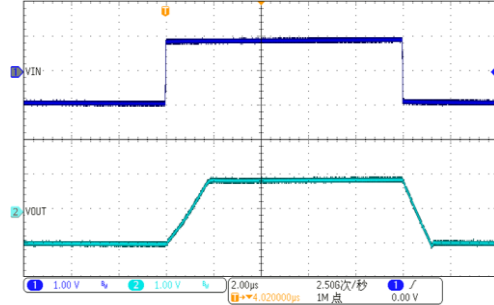
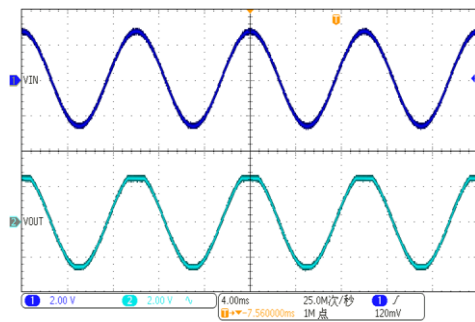
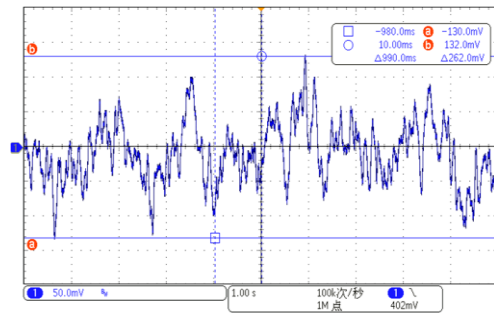
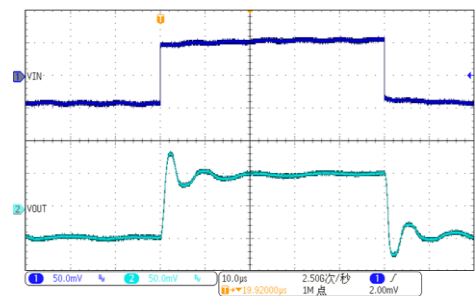
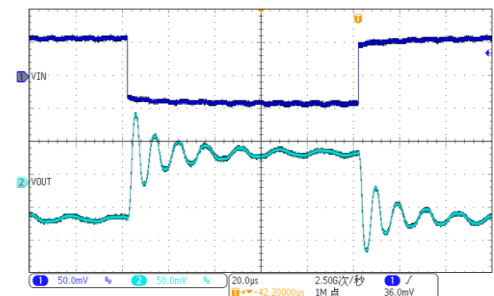
**Small-Signal Step Response, 100mV Step**

**Large-Signal Step Response, 2V Step**

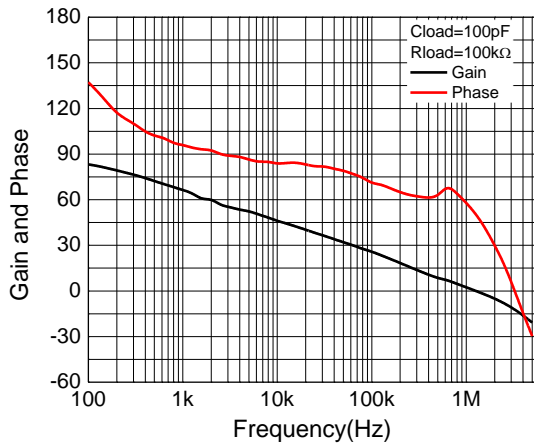
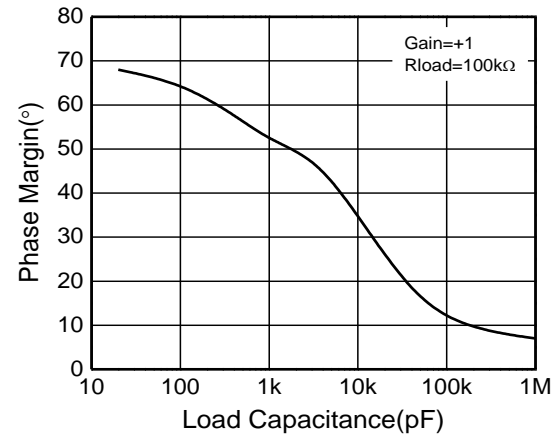
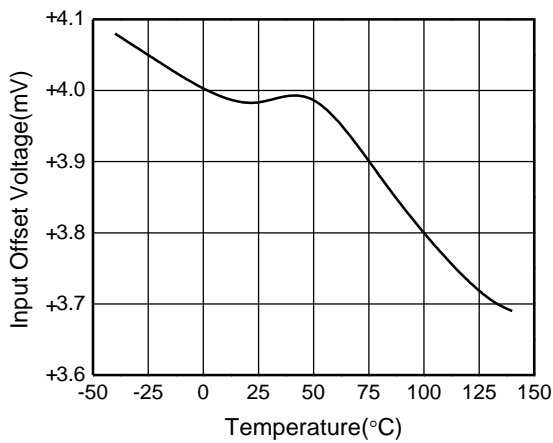
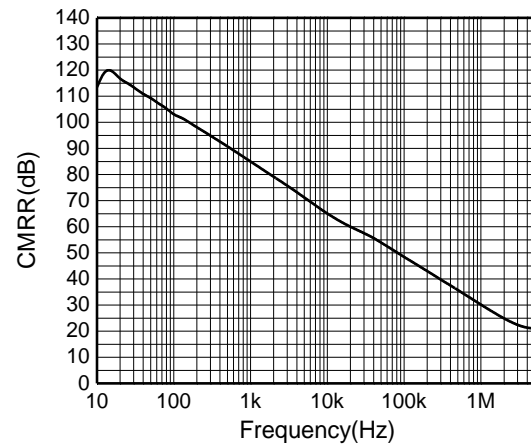
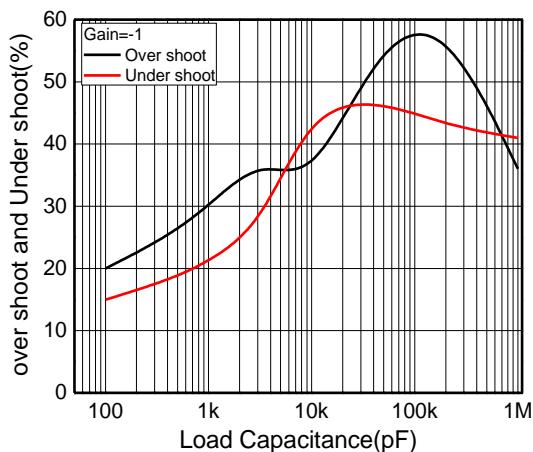
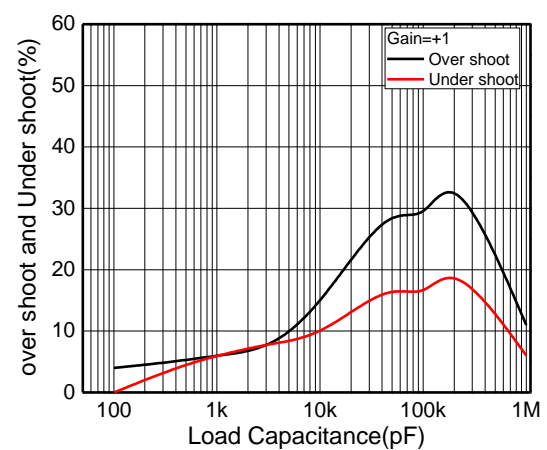
**VIN=-0.2V to 5.7V, No Phase Reversal**

**0.1Hz to 10Hz Integrated Input Noise, Gain = 50000**

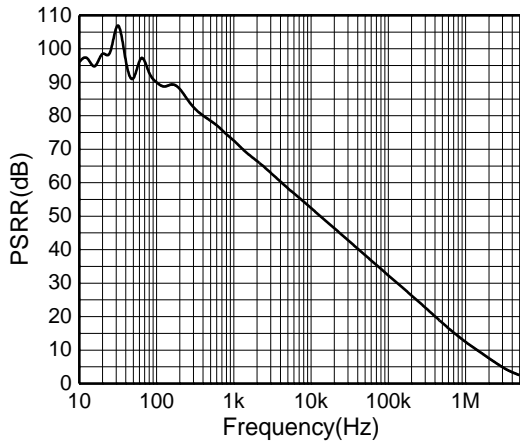
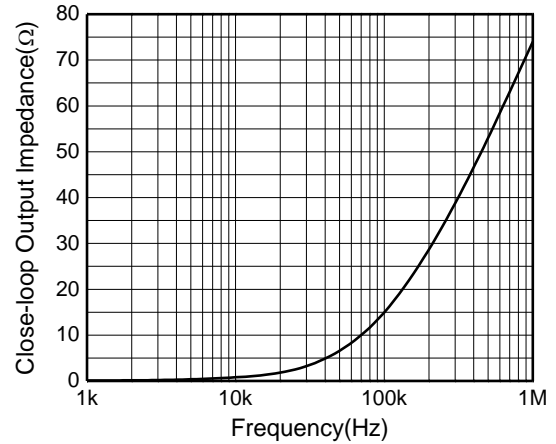
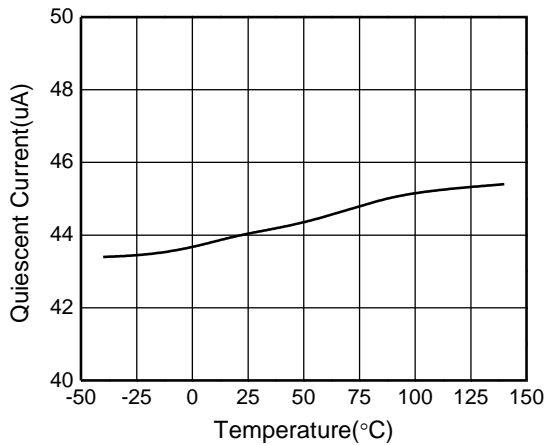
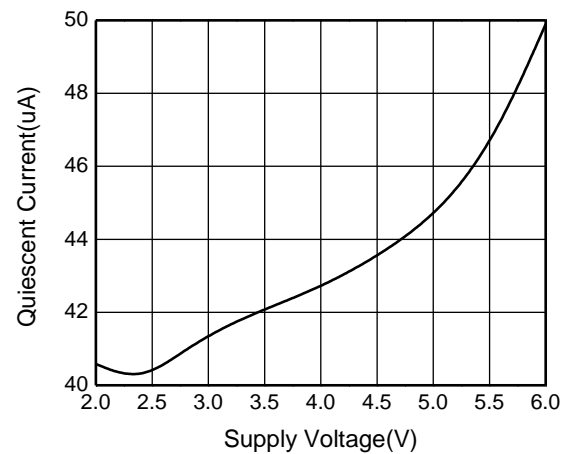
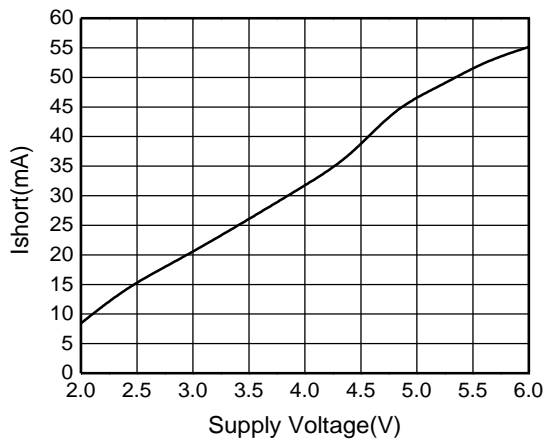
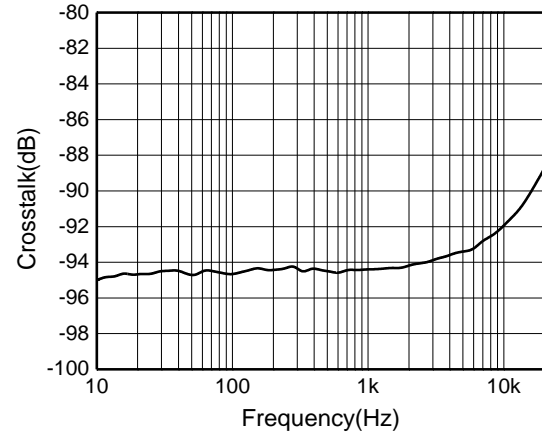
**Over Shoot Voltage,  $C_{load}=47\text{nF}$ ,  $R_{FB}=10\text{k}\Omega$ , Gain=+1**

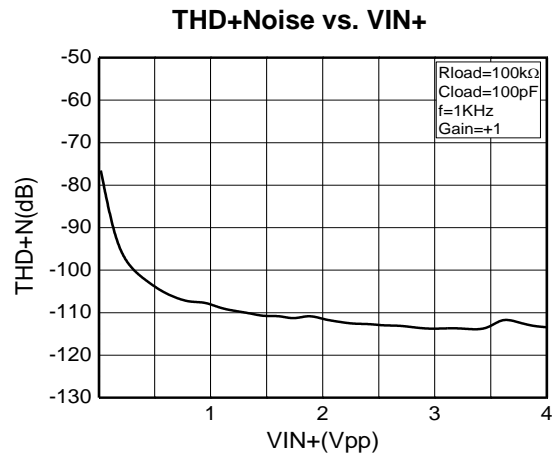
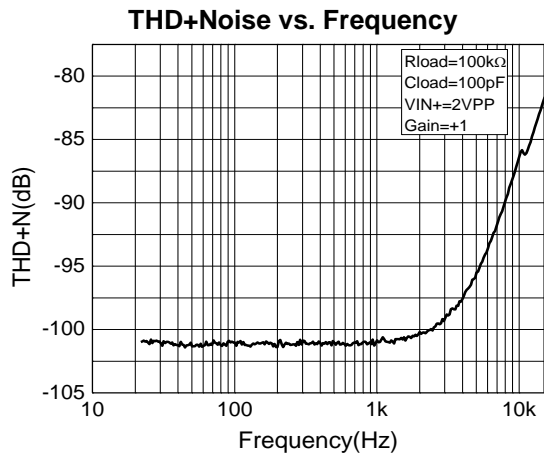
**Over Shoot Voltage,  $C_{load}=47\text{nF}$ ,  $R_{load}=40\text{k}\Omega$ , Gain=-1**

**Typical Characteristics (continued)**
 $T_A=25^\circ\text{C}$ ,  $V_S=\pm 2.5\text{V}$ ,  $V_{CM}=0\text{V}$ , unless otherwise noted

**Open-Loop Gain and Phase**

**Phase Margin vs.  $C_{load}$  (Stable for Any  $C_{load}$ )**

**Input Offset Voltage vs. Temperature**

**CMRR vs. Frequency**

**Over-Shoot % vs.  $C_{load}$** 
**Gain=-1,  $R_{FB}=20\text{k}\Omega$** 

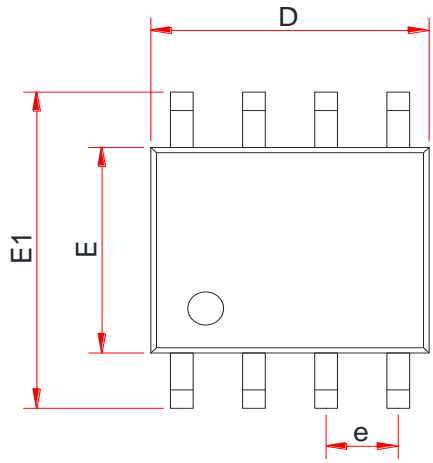
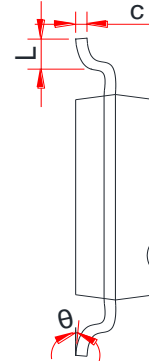
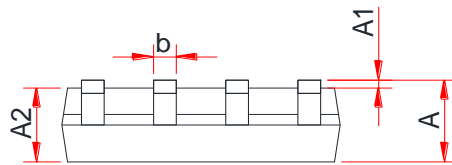
**Over-Shoot % vs.  $C_{load}$** 
**Gain=+1**

**Typical Characteristics (continued)**
 $T_A=25^\circ\text{C}$ ,  $V_S=\pm 2.5\text{V}$ ,  $V_{CM}=0\text{V}$ , unless otherwise noted

**PSRR vs. Frequency**

**Closed-Loop Output Impedance vs. Frequency**

**Quiescent Supply Current vs. Temperature**

**Quiescent Supply Current vs. Supply Voltage**

**Short-Circuit Current vs. Supply Voltage**

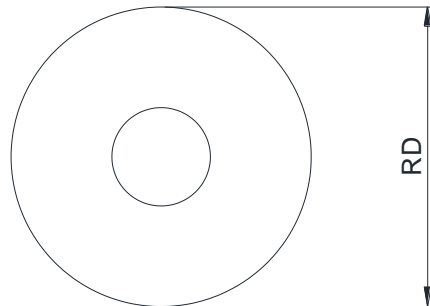
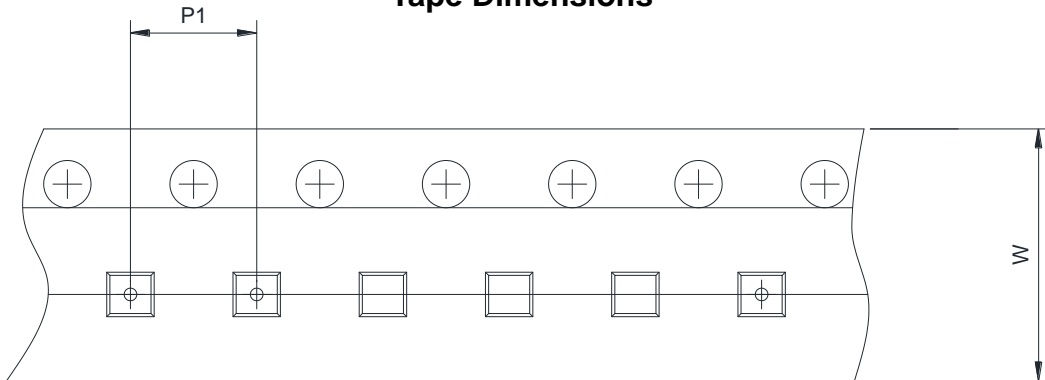
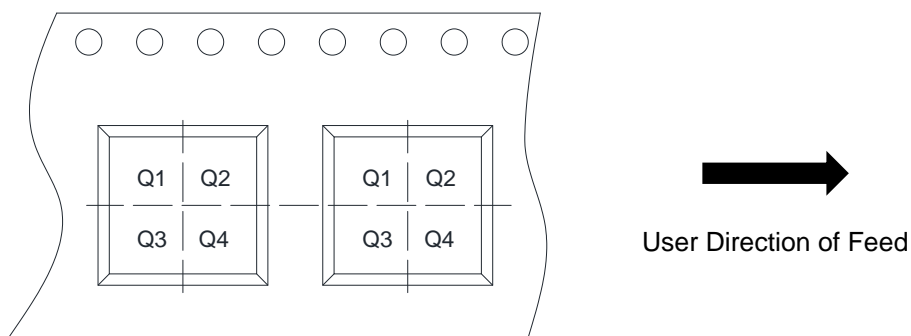
**Crosstalk**

**Typical Characteristics (continued)**
 $T_A=25\text{ }^\circ\text{C}$ ,  $V_S=\pm 2.5\text{V}$ ,  $V_{CM}=0\text{V}$ , unless otherwise noted



**PACKAGE OUTLINE DIMENSIONS**
**SOP-8L**

**TOP VIEW**

**SIDE VIEW**

**SIDE VIEW**

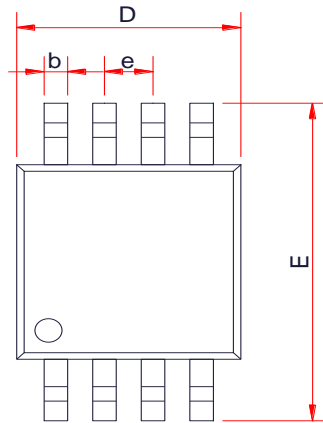
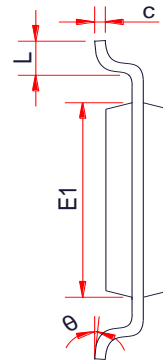
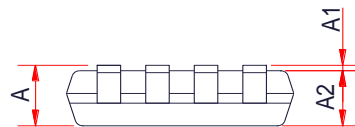
Symbol	Dimensions In Millimeters (mm)		
	Min.	Typ.	Max.
A	1.35	1.55	1.75
A1	0.05	0.15	0.25
A2	1.25	1.40	1.65
b	0.33	-	0.51
c	0.15	-	0.26
D	4.70	4.90	5.10
E	3.70	3.90	4.10
E1	5.80	6.00	6.20
e	1.27BSC		
L	0.40	-	1.27
$\theta$	0°	-	8°

**TAPE AND REEL INFORMATION**
**SOP-8L**
**Reel Dimensions**

**Tape Dimensions**

**Quadrant Assignments For PIN1 Orientation In Tape**

RD	Reel Dimension	<input type="checkbox"/> 7inch	<input checked="" type="checkbox"/> 13inch		
W	Overall width of the carrier tape	<input type="checkbox"/> 8mm	<input checked="" type="checkbox"/> 12mm		
P1	Pitch between successive cavity centers	<input type="checkbox"/> 2mm	<input type="checkbox"/> 4mm	<input checked="" type="checkbox"/> 8mm	
Pin1	Pin1 Quadrant	<input checked="" type="checkbox"/> Q1	<input type="checkbox"/> Q2	<input type="checkbox"/> Q3	<input type="checkbox"/> Q4

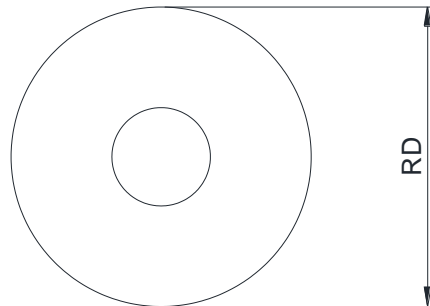
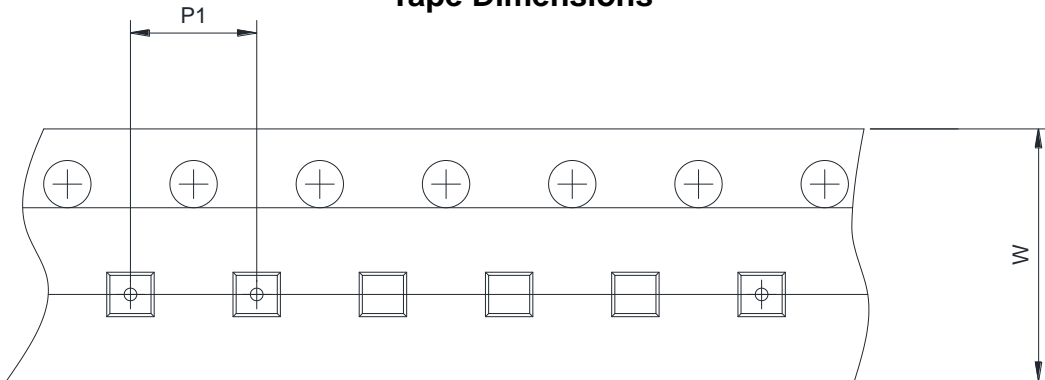
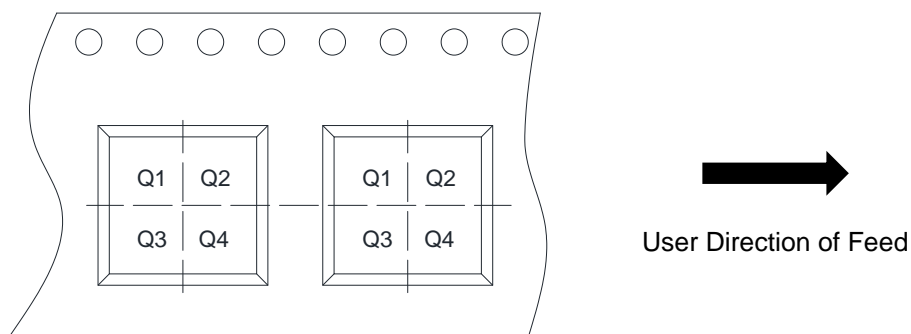
**PACKAGE OUTLINE DIMENSIONS**
**MSOP-8L**

**TOP VIEW**

**SIDE VIEW**

**SIDE VIEW**

Symbol	Dimensions In Millimeters (mm)		
	Min.	Typ.	Max.
A	-	-	1.10
A1	0.02	-	0.15
A2	0.75	0.80	0.95
b	0.25	-	0.38
c	0.09	-	0.23
D	2.90	3.00	3.10
E	4.75	4.90	5.05
E1	2.90	3.00	3.10
e	0.65 BSC		
L	0.40	-	0.80
θ	0°	-	6°

**TAPE AND REEL INFORMATION**
**MSOP-8L**
**Reel Dimensions**

**Tape Dimensions**

**Quadrant Assignments For PIN1 Orientation In Tape**

RD	Reel Dimension	<input type="checkbox"/> 7inch	<input checked="" type="checkbox"/> 13inch		
W	Overall width of the carrier tape	<input type="checkbox"/> 8mm	<input checked="" type="checkbox"/> 12mm		
P1	Pitch between successive cavity centers	<input type="checkbox"/> 2mm	<input type="checkbox"/> 4mm	<input checked="" type="checkbox"/> 8mm	
Pin1	Pin1 Quadrant	<input checked="" type="checkbox"/> Q1	<input type="checkbox"/> Q2	<input type="checkbox"/> Q3	<input type="checkbox"/> Q4

## X-ON Electronics

Largest Supplier of Electrical and Electronic Components

*Click to view similar products for [Operational Amplifiers - Op Amps](#) category:*

*Click to view products by [Will Semiconductor](#) manufacturer:*

Other Similar products are found below :

[OPA2991IDSGR](#) [OPA607IDCKT](#) [007614D](#) [633773R](#) [635798C](#) [635801A](#) [702115D](#) [709228FB](#) [741528D](#) [NCV33072ADR2G](#)  
[SC2902DTBR2G](#) [SC2903DR2G](#) [SC2903VDR2G](#) [LM258AYDT](#) [LM358SNG](#) [430227FB](#) [430228DB](#) [460932C](#) [AZV831KTR-G1](#) [409256CB](#)  
[430232AB](#) [LM2904DR2GH](#) [LM358YDT](#) [LT1678IS8](#) [042225DB](#) [058184EB](#) [070530X](#) [SC224DR2G](#) [SC239DR2G](#) [SC2902DG](#)  
[SCYA5230DR2G](#) [714228XB](#) [714846BB](#) [873836HB](#) [MIC918YC5-TR](#) [TS912BIYDT](#) [NCS2004MUTAG](#) [NCV33202DMR2G](#)  
[M38510/13101BPA](#) [NTE925](#) [SC2904DR2G](#) [SC358DR2G](#) [LM358EDR2G](#) [AZV358MTR-G1](#) [AP4310AUMTR-AG1](#) [HA1630D02MMEL-E](#)  
[NJM358CG-TE2](#) [HA1630S01LPEL-E](#) [LM324AWPT](#) [HA1630Q06TELL-E](#)