

**WS72541**
**Low-Power Rail-to-Rail Input Output Operational Amplifiers**
[Http://www.willsemi.com](http://www.willsemi.com)
**Descriptions**

The WS72541 series is a single low-voltage operational amplifier with rail-to-rail input/output swing. Ultra low quiescent current makes this amplifier ideal for portable, battery operated equipment. The common mode input range includes ground making the device useful for low-side current-shunt measurements. The ultra small packages allow for placement on the PCB in close proximity to the signal source thereby reducing noise pickup.

The WS72541 is available with MSL 3 Level in SOT353(SC70-5L) package and SOT23-5L package. Standard products are Pb-Free and halogen-Free.

**Applications**

- Active Filters
- Smoke/Gas Sensors
- Battery Powered Electronic Equipments
- Personal Medical Care

**Features**

- Single Supply Voltage : 1.8~5.5V
- Quiescent Current : 48μA Typical
- GBWP : 2MHz
- Slew Rate : 1.4V/μs
- Offset Voltage : 2mV Maximum
- Offset Voltage Temp. Drift : 0.5μV / °C
- THD+N : -102dB@1kHz,  
-90dB@10kHz
- CMRR/PSRR : 104dB/111dB
- Output Short-Circuit Curr. : 43mA
- -40°C to 125°C Operation Range
- Drives 2kΩ Resistive Loads
- No Output Crossover Distortion
- No Phase Reversal from Overdriven Input
- Rail-to-Rail Input/Output Swing

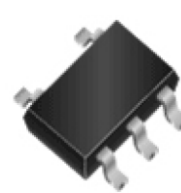
**SOT353**

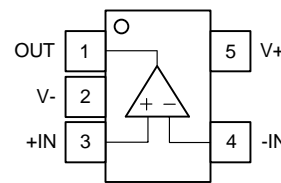
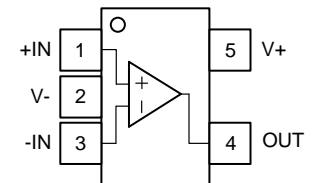
**SOT23-5L**

**SOT23-5L**

**SOT353/SOT23-5L**
**Pin configuration (Top view)**

**SOT353**

**SOT23-5L**
**Marking**

- 2541** = Device code
- GB** = Special code
- GE** = Special code
- Y** = Year code
- W** = Week code

**Order Information**

Device	Package	Shipping
WS72541B-5/TR	SOT353	3000/Reel &Tape
WS72541E-5/TR	SOT23-5L	3000/Reel &Tape

**Pin Descriptions (WS72541B-5/TR & WS72541E-5/TR)**

Pin Number	Symbol	Descriptions
1	+IN	Non-inverting input
2	V-	Negative supply
3	-IN	Inverting input
4	OUT	Output
5	V+	Positive supply

**Absolute Maximum Ratings**

Parameter	Symbol	Value	Unit
Supply Voltage, ([V+] - [V-])	$V_S^{(2)}$	6	V
Input Differential Voltage	$V_{IDR}^{(3)}$	$\pm 6$	V
Input Common Mode Voltage Range	$V_{ICR}$	(V)-0.2 to (V <sup>+</sup> )+0.2	V
Output Short-Circuit Duration	$t_{SO}$	Unlimited	/
Operating Free-Air Temperature Range	$T_A$	-40 to 125	°C
Storage Temperature Range	$T_{STG}$	-65 to 150	°C
Junction Temperature Range	$T_J$	150	°C
Lead Temperature Range	$T_L$	260	°C

**Note:**

- Stresses beyond those listed under Absolute Maximum Ratings may cause permanent damage to the device. These are only stress ratings, and functional operation of the device at these or any other conditions beyond those indicated under recommended operating conditions are not implied. Exposure to absolute-maximum-rated conditions for extended periods may affect device reliability.
- All voltage values, except differential voltage are with respect to network terminal.
- Differential voltages are at +IN with respect to -IN.

**ESD, Electrostatic Discharge Protection**

Symbol	Parameter	Condition	Minimum level	Unit
HBM	Human Body Model ESD	MIL-STD-883H Method 3015.8 JEDEC-EIA/JESD22-A114A	$\pm 8000$	V
MM	Machine Model ESD	JEDEC-EIA/JESD22-A115	$\pm 500$	V
CDM	Charged Device Model ESD	JEDEC-EIA/JESD22-C101E	$\pm 2000$	V

**Electronics Characteristics**

The \*denotes the specifications which apply over the full operating temperature range, otherwise specifications are at  $T_A = 25^\circ\text{C}$ .  $V_S = 5\text{V}$ ,  $V_{\text{CM}} = V_{\text{OUT}} = V_S/2$ ,  $R_{\text{load}} = 100\text{k}\Omega$ ,  $C_{\text{load}} = 100\text{pF}$ .

Symbol	Parameter		Conditions	Min.	Typ.	Max.	Unit	
$V_{\text{OS}}$	Input Offset Voltage		$V_{\text{CM}} = V_S/2$	*	-2.0	$\pm 0.1$	2.0	mV
$\alpha_{\text{VOS}}$	Input Offset Voltage Drift				0.5		$\mu\text{V}/^\circ\text{C}$	
$I_{\text{IB}}$	Input Bias Current				10		pA	
$I_{\text{OS}}$	Input Offset Current				10		pA	
$V_n$	Input Voltage Noise		$f=0.1\text{Hz to }10\text{Hz}$		4		$\mu\text{V}_{\text{P-P}}$	
$e_n$	Input Voltage Noise Density		$f=1\text{kHz}$		30		$\text{nV}/\sqrt{\text{Hz}}$	
			$f=10\text{kHz}$		23			
CMRR	Common Mode Rejection Ratio		$V_{\text{CM}}=0.1\text{V to }4.9\text{V}$	*	80	104		dB
$V_{\text{CM}}$	Common Mode Input Voltage Range			*	$(V^-)-0.2$		$(V^+)+0.2$	V
PSRR	Power Supply Rejection Ratio			*	80	111		dB
$A_{\text{VOL}}$	Open Loop Large Signal Gain		$V_{\text{OUT}}=0.1\text{V to }4.9\text{V}$ , $R_{\text{load}}=10\text{k}\Omega$	*	100	108		dB
$V_{\text{OH}}$	High Level Output Voltage		$R_{\text{load}}=2\text{k}\Omega$			50		mV
			$R_{\text{load}}=10\text{k}\Omega$			5		
$V_{\text{OL}}$	Low Level Output Voltage		$R_{\text{load}}=2\text{k}\Omega$			40		mV
			$R_{\text{load}}=10\text{k}\Omega$			5		
$I_{\text{SC}}$	Output Short-Circuit Current		Source Current			43		mA
			Sink Current			47		
$I_{\text{Q}}$	Quiescent Current			*		48	65	$\mu\text{A}$
PM	Phase Margin		$R_{\text{load}}=100\text{k}\Omega$ , $C_{\text{load}}=100\text{pF}$			60		degrees
GM	Gain Margin		$R_{\text{load}}=100\text{k}\Omega$ , $C_{\text{load}}=100\text{pF}$			-14		dB
GBWP	Gain-Bandwidth Product		$f=1\text{kHz}$			2		MHz
$t_s$	Settling Time	1.5 to 3.5V, Unity Gain	0.1%			1.9		$\mu\text{s}$
		2.45 to 2.55V, Unity Gain	0.1%			0.29		
SR	Slew Rate		$A_V=1$ , $V_{\text{OUT}}=1.5\text{V to }3.5\text{V}$ , $R_{\text{load}}=100\text{k}\Omega$ , $C_{\text{load}}=100\text{pF}$			1.4		$\text{V}/\mu\text{s}$
FPBW	Full Power Bandwidth		$2V_{\text{P-P}}$			240		kHz
THD+N	Total Harmonic Distortion and Noise		$f=1\text{kHz}$ , $A_V=1$ , $R_{\text{load}}=100\text{k}\Omega$ , $V_{\text{OUT}}=2V_{\text{PP}}$			-102		dB
			$f=10\text{kHz}$ , $A_V=1$ , $R_{\text{load}}=100\text{k}\Omega$ , $V_{\text{OUT}}=2V_{\text{PP}}$			-90		

**Note:**

1. Stresses beyond those listed under Absolute Maximum Ratings may cause permanent damage to the device. Exposure to any Absolute Maximum Rating condition for extended periods may affect device reliability and lifetime.
2. A heat sink may be required to keep the junction temperature below the absolute maximum rating when the output is shorted indefinitely.
3. Thermal resistance varies with the amount of PC board metal connected to the package. The specified values are for short traces connected to the leads.
4. Full power bandwidth is calculated from the slew rate  $FPBW = SR/(\pi \cdot V_{P-P})$ .

**Typical Characteristics**
 $T_A=25^\circ\text{C}$ ,  $V_S=\pm 2.5\text{V}$ ,  $V_{CM}=0\text{V}$ , unless otherwise noted

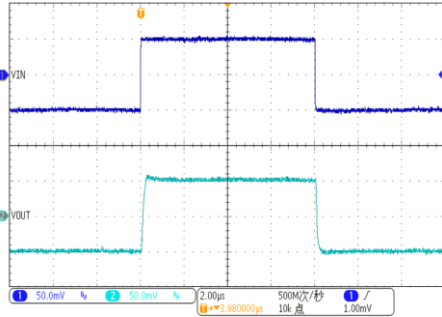
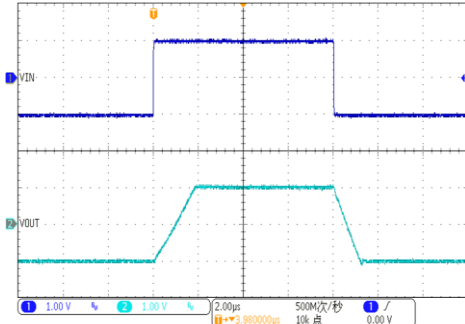
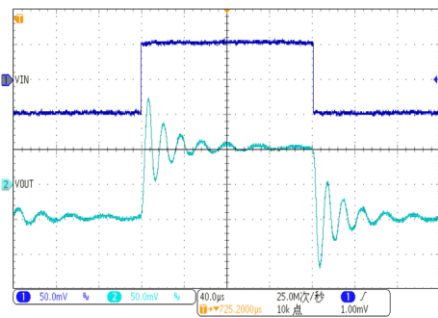
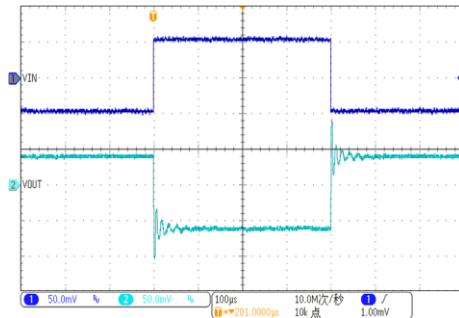
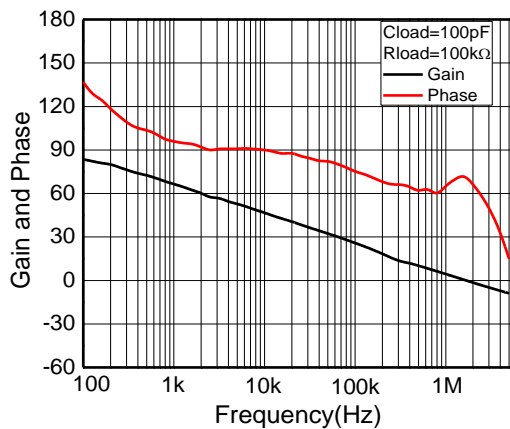
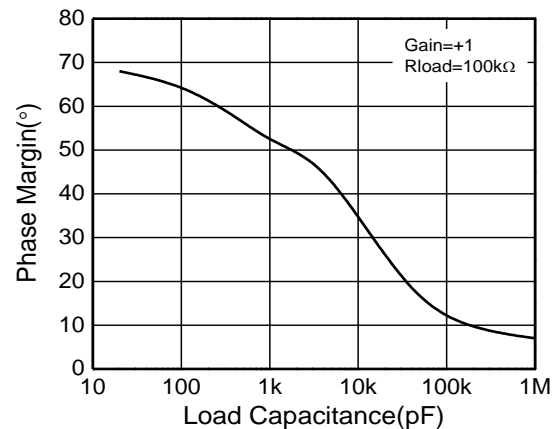
**Small-Signal Step Response, 100mV Step**

**Large-Signal Step Response, 2V Step**

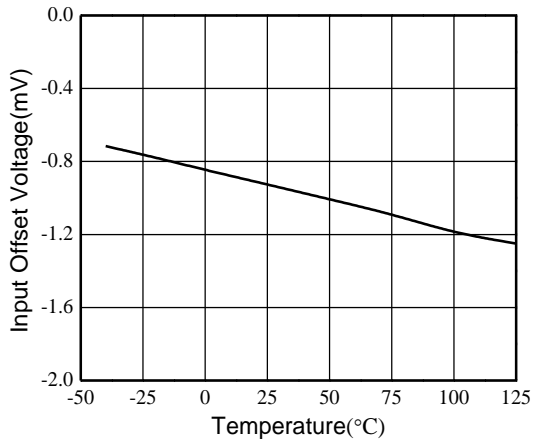
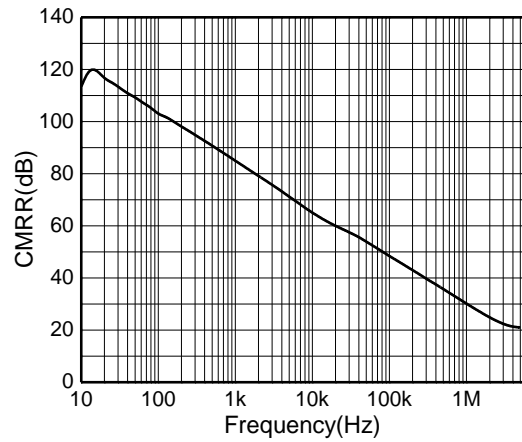
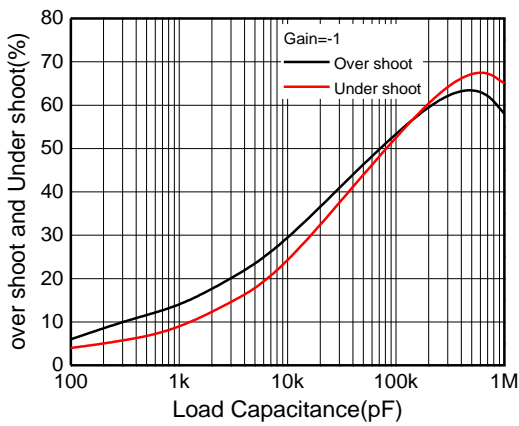
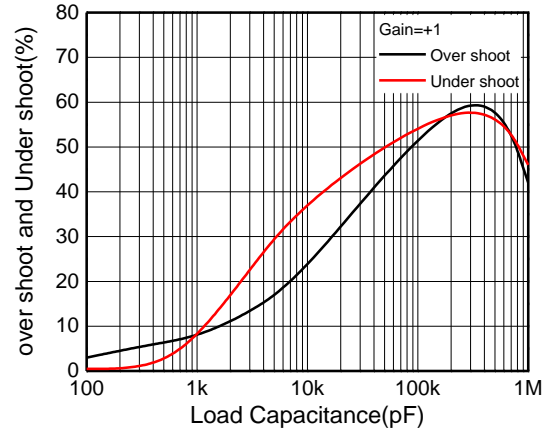
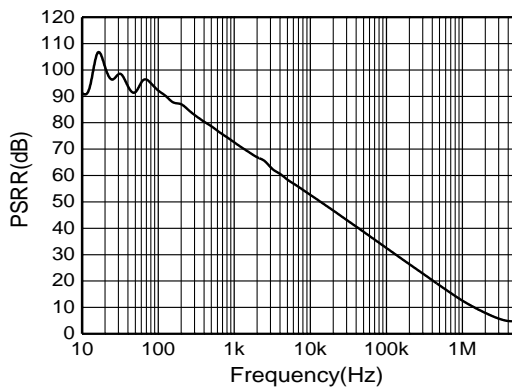
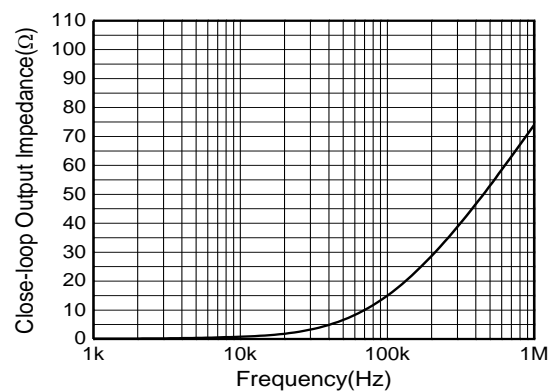
**Over Shoot Voltage,  $C_{load}=47\text{nF}$ ,  
 $R_{FB}=10\text{k}\Omega$ , Gain=+1**

**Over Shoot Voltage,  $C_{load}=47\text{nF}$ ,  
 $R_{load}=40\text{k}\Omega$ , Gain=-1**

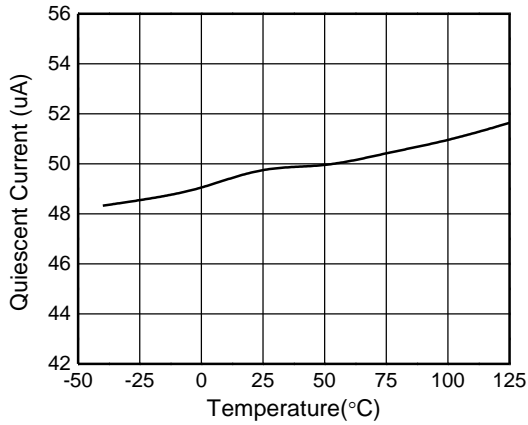
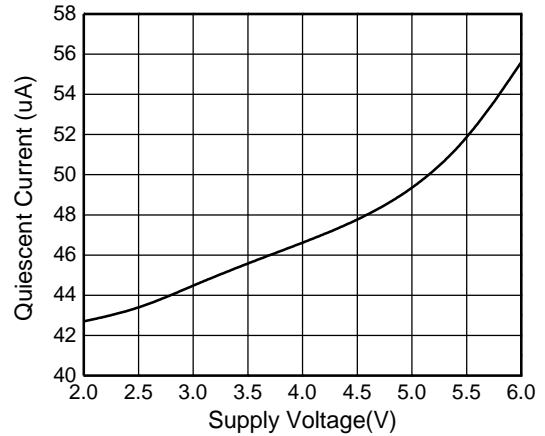
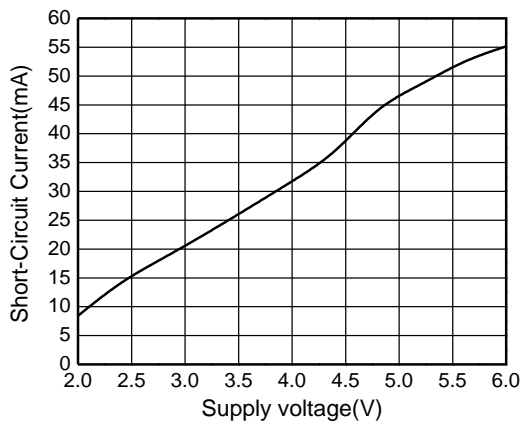
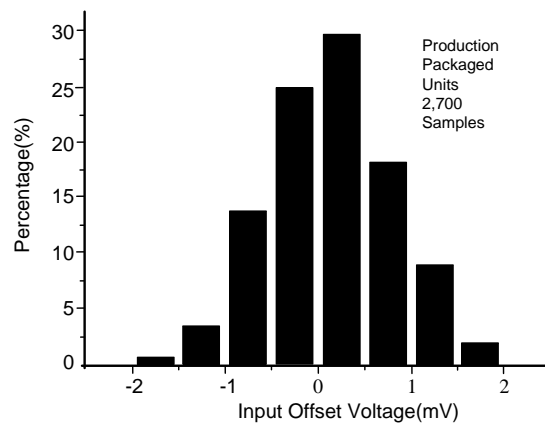
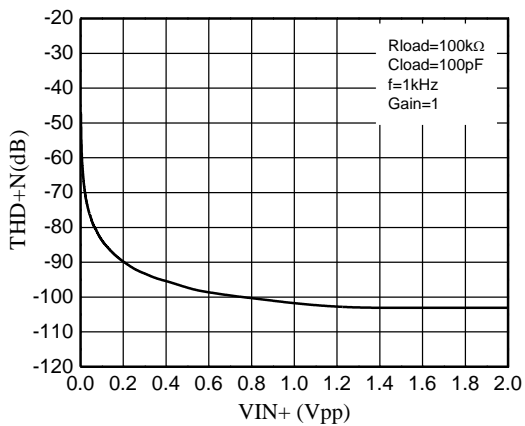
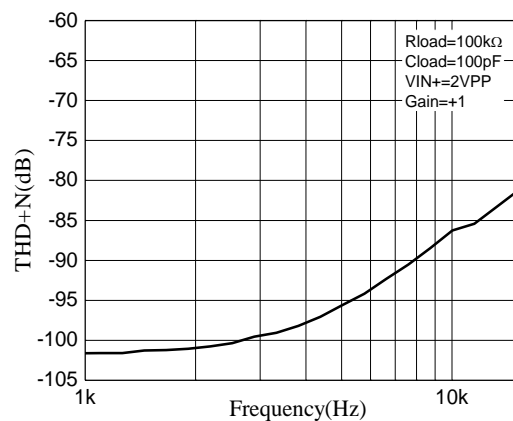
**Open-Loop Gain and Phase**

**Phase Margin vs.  $C_{load}$  (Stable for Any  $C_{load}$ )**

**Typical Characteristics (continued)**
 $T_A=25^\circ\text{C}$ ,  $V_S=\pm 2.5\text{V}$ ,  $V_{CM}=0\text{V}$ , unless otherwise noted

**Input Offset Voltage vs. Temperature**

**CMRR vs. Frequency**

**Over-Shoot % vs.  $C_{load}$   
Gain=-1, RFB=20k $\Omega$** 

**Over-Shoot % vs.  $C_{load}$   
Gain=+1**

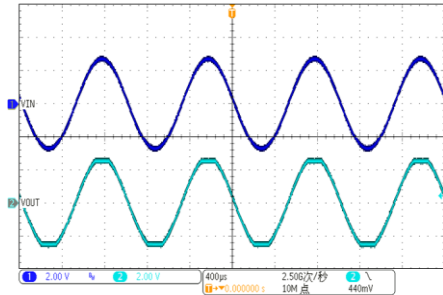
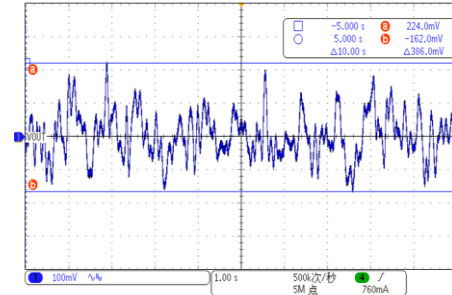
**PSRR vs. Frequency**

**Closed-Loop Output Impedance vs. Frequency**

**Typical Characteristics (continued)**
 $T_A=25^\circ\text{C}$ ,  $V_S=\pm 2.5\text{V}$ ,  $V_{CM}=0\text{V}$ , unless otherwise noted

**Quiescent Supply Current vs. Temperature**

**Quiescent Supply Current vs. Supply Voltage**

**Short-Circuit Current vs. Supply Voltage**

**Input Offset Voltage Distribution**

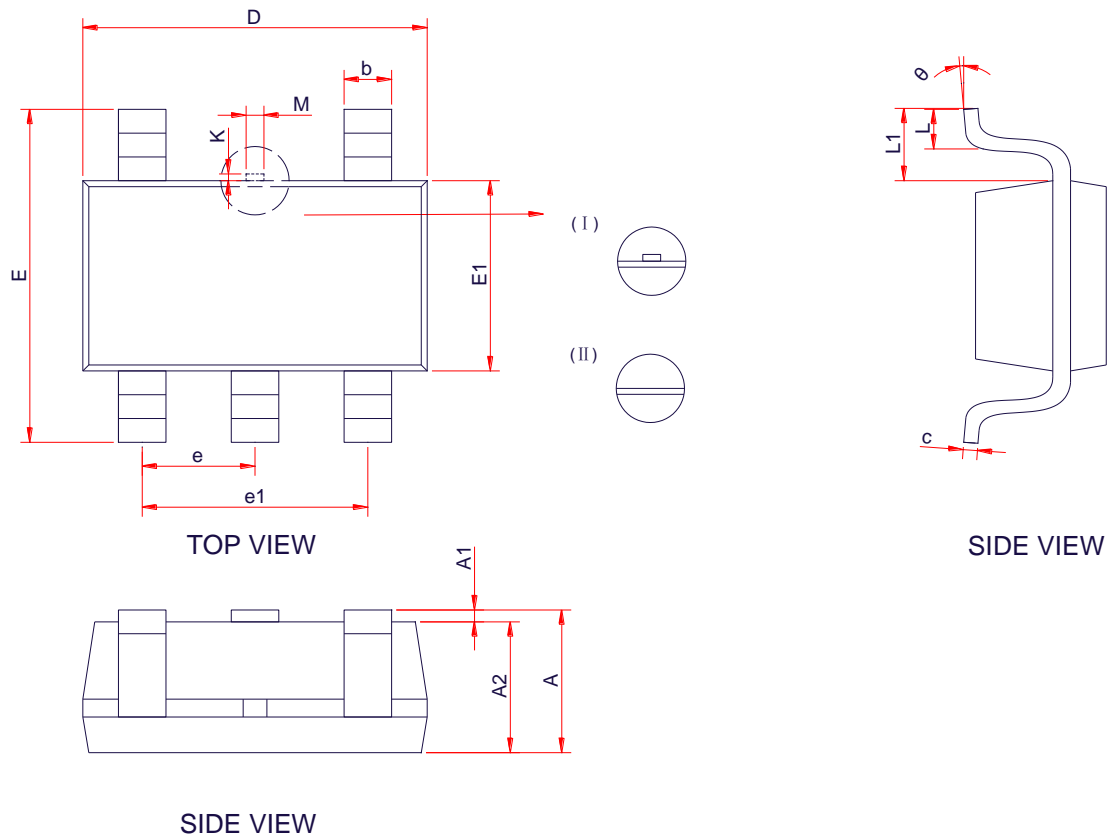
**THD+Noise vs. Vin+**

**THD+Noise vs. Frequency**

**Typical Characteristics (continued)**
 $T_A=25^{\circ}\text{C}$ ,  $V_S=\pm 2.5\text{V}$ ,  $V_{CM}=0\text{V}$ , unless otherwise noted

**VIN=-0.2V to 5.7V, No Phase Reversal**

**0.1Hz to 10Hz Integrated Input Noise,  
Gain = 10000**

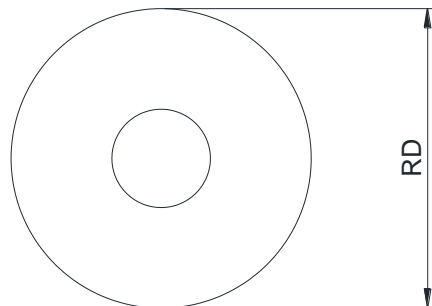
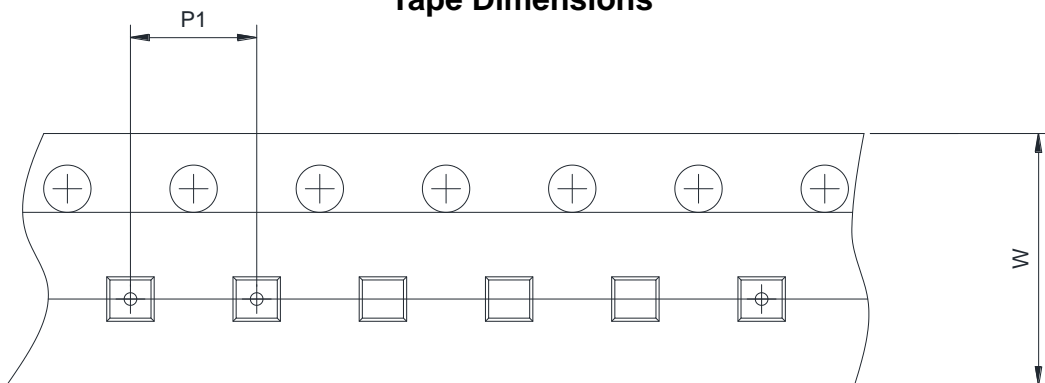
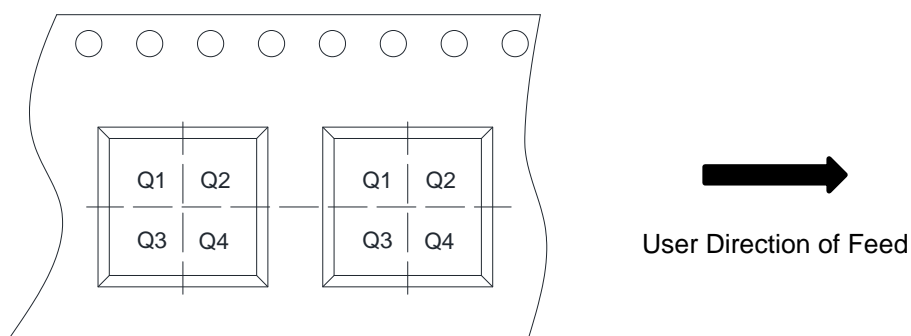

**PACKAGE OUTLINE DIMENSIONS**
**SOT-353(SC70-5L)**

Symbol	Dimensions in Millimeters		
	Min.	Typ.	Max.
A	0.80	0.95	1.10
A1	0.00	-	0.10
A2	0.80	0.90	1.00
b	0.15	0.25	0.35
c	0.08	-	0.20
D	2.00	2.10	2.20
E1	1.15	1.25	1.35
E	2.15	2.30	2.45
e	0.65 Typ.		
e1	1.20	1.30	1.40
L1	0.50 Ref.		
L	0.26	0.36	0.46
M	0.10	0.15	0.25
K	0.00	-	0.25
θ	0 °	-	14 °

**TAPE AND REEL INFORMATION**
**Reel Dimensions**

**Tape Dimensions**

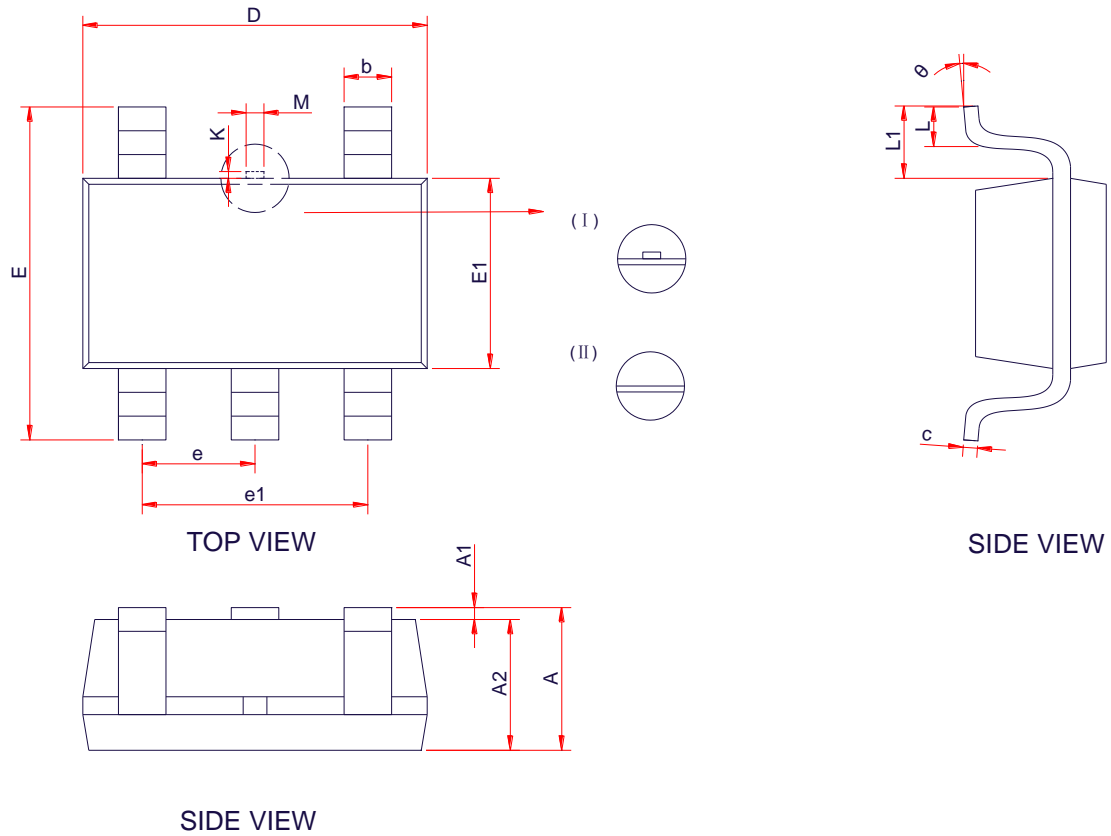
**Quadrant Assignments For PIN1 Orientation In Tape**

RD	Reel Dimension	<input checked="" type="checkbox"/> 7inch	<input type="checkbox"/> 13inch		
W	Overall width of the carrier tape	<input checked="" type="checkbox"/> 8mm	<input type="checkbox"/> 12mm		
P1	Pitch between successive cavity centers	<input type="checkbox"/> 2mm	<input checked="" type="checkbox"/> 4mm	<input type="checkbox"/> 8mm	
Pin1	Pin1 Quadrant	<input type="checkbox"/> Q1	<input type="checkbox"/> Q2	<input checked="" type="checkbox"/> Q3	<input type="checkbox"/> Q4

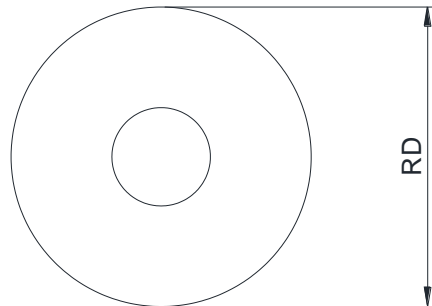
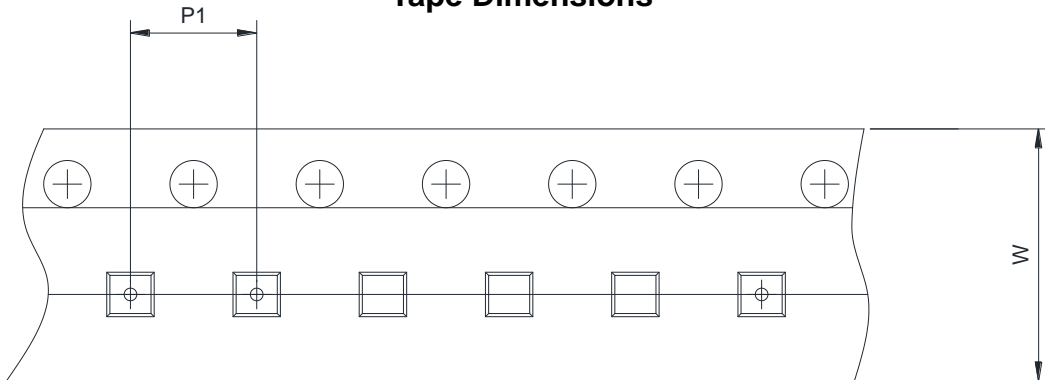
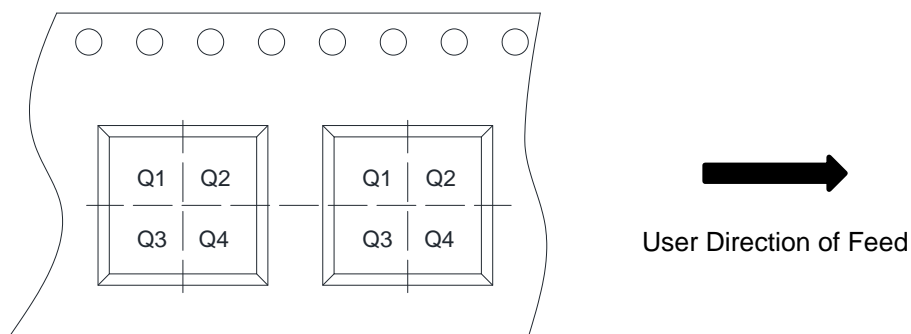
**PACKAGE OUTLINE DIMENSIONS**
**SOT-23-5L**

Symbol	Dimensions in Millimeters		
	Min.	Typ.	Max.
A	-	-	1.45
A1	0.00	-	0.15
A2	0.90	1.10	1.30
b	0.30	0.40	0.50
c	0.10	-	0.21
D	2.72	2.92	3.12
E	2.60	2.80	3.00
E1	1.40	1.60	1.80
e	0.95 BSC		
e1	1.90 BSC		
L	0.30	0.45	0.60
M	0.10	0.15	0.25
K	0.00	-	0.25
θ	0°	-	8°

**TAPE AND REEL INFORMATION**
**Reel Dimensions**

**Tape Dimensions**

**Quadrant Assignments For PIN1 Orientation In Tape**

RD	Reel Dimension	<input checked="" type="checkbox"/> 7inch	<input type="checkbox"/> 13inch
W	Overall width of the carrier tape	<input checked="" type="checkbox"/> 8mm	<input type="checkbox"/> 12mm <input type="checkbox"/> 16mm
P1	Pitch between successive cavity centers	<input type="checkbox"/> 2mm	<input checked="" type="checkbox"/> 4mm <input type="checkbox"/> 8mm
Pin1	Pin1 Quadrant	<input type="checkbox"/> Q1	<input type="checkbox"/> Q2 <input checked="" type="checkbox"/> Q3 <input type="checkbox"/> Q4

## X-ON Electronics

Largest Supplier of Electrical and Electronic Components

*Click to view similar products for [Operational Amplifiers - Op Amps](#) category:*

*Click to view products by [Will Semiconductor](#) manufacturer:*

Other Similar products are found below :

[OPA2991IDSGR](#) [OPA607IDCKT](#) [007614D](#) [633773R](#) [635798C](#) [635801A](#) [702115D](#) [709228FB](#) [741528D](#) [NCV33072ADR2G](#)  
[SC2902DTBR2G](#) [SC2903DR2G](#) [SC2903VDR2G](#) [LM258AYDT](#) [LM358SNG](#) [430227FB](#) [430228DB](#) [460932C](#) [AZV831KTR-G1](#) [409256CB](#)  
[430232AB](#) [LM2904DR2GH](#) [LM358YDT](#) [LT1678IS8](#) [042225DB](#) [058184EB](#) [070530X](#) [SC224DR2G](#) [SC239DR2G](#) [SC2902DG](#)  
[SCYA5230DR2G](#) [714228XB](#) [714846BB](#) [873836HB](#) [MIC918YC5-TR](#) [TS912BIYDT](#) [NCS2004MUTAG](#) [NCV33202DMR2G](#)  
[M38510/13101BPA](#) [NTE925](#) [SC2904DR2G](#) [SC358DR2G](#) [LM358EDR2G](#) [AZV358MTR-G1](#) [AP4310AUMTR-AG1](#) [HA1630D02MMEL-E](#)  
[NJM358CG-TE2](#) [HA1630S01LPEL-E](#) [LM324AWPT](#) [HA1630Q06TELL-E](#)