

**WS72551/WS72552**
**Zero-Drift, Single-Supply, Rail-to-Rail Input/Output Operational Amplifiers**
[Http://www.willsemi.com](http://www.willsemi.com)
**Descriptions**

This family of amplifiers has ultra low offset, drift, and bias current. The WS72551 and WS72552 are single and dual amplifiers featuring rail-to-rail input and output swings respectively. All are guaranteed to operate from 2.5V to 5V with a single supply.

The WS72551/WS72552 provides the benefits previously found only in expensive auto-zeroing or chopper-stabilized amplifiers. These new zero-drift amplifiers combine low cost with high accuracy. No external capacitors are required.

With an offset voltage of only 3 $\mu$ V and drift of 0.008  $\mu$ V/ $^{\circ}$ C, the WS72551/WS72552 are perfectly suited for applications in which error sources cannot be tolerated. Temperature, position and pressure sensors, medical equipment, and strain gauge amplifiers benefit greatly from nearly zero drift over their operating temperature range. The rail-to-rail input and output swings provided by the WS72551/WS72552 make both high-side and low-side sensing easy.

The WS72551/WS72552 are specified for the extended industrial/automotive temperature range (-40 $^{\circ}$ C to +125 $^{\circ}$ C). The WS72551 single amplifier is available in 8-lead MSOP, 8-lead narrow SOIC and 5-lead SOT23-5L packages. The WS72552 dual amplifier is available in 8-lead MSOP and 8-lead narrow SOIC surface mount packages.

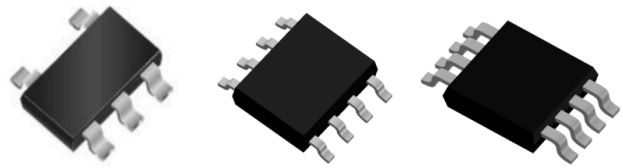
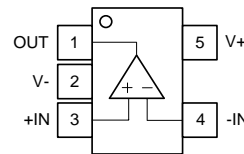
**SOT23-5L**
**SOP-8L**
**MSOP-8L**

**SOT23-5L**

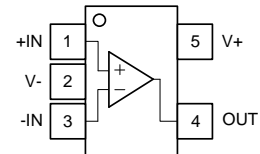
(WS72551EA-5/TR)

**SOT23-5L**

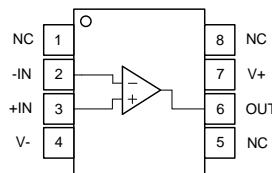
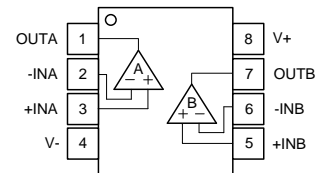
(WS72551E-5/TR)

**SOP-8L/MSOP-8L**

**SOP-8L/MSOP-8L**
**Pin configuration (Top view)**

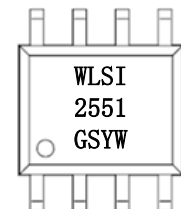
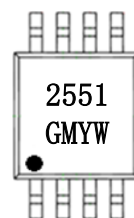
**SOT23-5L**

**SOT23-5L**

**SOP-8L**

**MSOP-8L**

**SOP-8L**

**MSOP-8L**

**Applications**

- Temperature sensors
- Pressure sensors
- Precision current sensing
- Strain gauge amplifiers
- Medical instrumentation
- Thermocouple amplifiers

**Marking**

- 2551** = Device code
- 2552** = Device code
- GA** = Special code
- GE** = Special code
- GS** = Special code
- GM** = Special code
- Y** = Year code
- W** = Week code

**Features**

- Low offset voltage : 14  $\mu$ V (MAX)
- Input offset drift : 0.008  $\mu$ V/°C
- Overload recovery time : 150  $\mu$ s
- Low supply current : 240  $\mu$ A/OpAmp
- High gain, CMRR, PSRR : 130 dB
- Ultralow input bias current : 10 pA
- No external capacitors required
- 5 V/2.5 V single-supply operation
- Rail-to-rail input and output swing

**Order information**

Device	Package	Shipping
WS72551S-8/TR	SOP-8L	4000/Reel &Tape
WS72551M-8/TR	MSOP-8L	4000/Reel &Tape
WS72551EA-5/TR	SOT23-5L	3000/Reel &Tape
WS72551E-5/TR	SOT23-5L	3000/Reel &Tape
WS72552S-8/TR	SOP-8L	4000/Reel &Tape
WS72552M-8/TR	MSOP-8L	4000/Reel &Tape

**Pin Descriptions**

	<b>Pin Number</b>	<b>Symbol</b>	<b>Descriptions</b>
WS72551S-8/TR and WS72551M-8/TR	1	NC	
	2	-IN	Inverting input
	3	+IN	Non-inverting input
	4	V-	Negative supply
	5	NC	
	6	OUT	Output
	7	V+	Positive supply
	8	NC	

	<b>Pin Number</b>	<b>Symbol</b>	<b>Descriptions</b>
WS72551EA-5/TR	1	OUT	Output
	2	V-	Negative supply
	3	+IN	Non-inverting input
	4	-IN	Inverting input
	5	V+	Positive supply

	<b>Pin Number</b>	<b>Symbol</b>	<b>Descriptions</b>
WS72551E-5/TR	1	+IN	Non-inverting input
	2	V-	Negative supply
	3	-IN	Inverting input
	4	OUT	Output
	5	V+	Positive supply

	<b>Pin Number</b>	<b>Symbol</b>	<b>Descriptions</b>
WS72552S-8/TR and WS72552M-8/TR	1	OUTA	Output
	2	-INA	Inverting input
	3	+INA	Non-inverting input
	4	V-	Negative supply
	5	+INB	Non-inverting input
	6	-INB	Inverting input
	7	OUTB	Output
	8	V+	Positive supply

**Absolute Maximum Ratings<sup>(1)</sup>**

Parameter	Rating	Unit
Supply Voltage <sup>(2)</sup>	6	V
Input Voltage	GND-0.2V to Vs+0.2	V
Differential Input Voltage	±5.0	V
ESD (Human Body Model)	7000	V
Output Short-Circuit Duration to GND	Indefinite	/
Storage Temperature Range	-65 to +150	°C
Junction Temperature Range	-65 to +150	°C
Lead Temperature Range (Soldering, 60 sec)	300	°C
Operating Temperature Range	-40 to +125	°C

**Note:**

- Stresses beyond those listed under Absolute Maximum Ratings may cause permanent damage to the device. These are only stress ratings, and functional operation of the device at these or any other conditions beyond those indicated under recommended operating conditions are not implied. Exposure to absolute-maximum-rated conditions for extended periods may affect device reliability.
- All voltage values, except differential voltage are with respect to network terminal.

**ESD, Electrostatic Discharge Protection**

Symbol	Parameter	Condition	Minimum level	Unit
HBM	Human Body Model ESD	MIL-STD-883H Method 3015.8 JEDEC-EIA/JESD22-A114A	±7000	V
MM	Machine Model ESD	JEDEC-EIA/JESD22-A115	±300	V
CDM	Charged Device Model ESD	JEDEC-EIA/JESD22-C101E	±2000	V

**Electronics Characteristics**
 $V_S = 5\text{ V}$ ,  $V_{CM} = 2.5\text{ V}$ ,  $V_O = 2.5\text{ V}$ ,  $T_A = 25^\circ\text{C}$ , unless otherwise noted.

Symbol	Parameter	Conditions	Min.	Typ.	Max.	Unit
$V_{OS}$	Offset Voltage			5	14	$\mu\text{V}$
$I_B$	Input Bias Current			10		$\mu\text{A}$
		$-40^\circ\text{C} \leq T_A \leq +85^\circ\text{C}$		50		$\mu\text{A}$
		$-40^\circ\text{C} \leq T_A \leq +125^\circ\text{C}$		0.5		$\text{nA}$
$I_{OS}$	Input Offset Current			6		$\mu\text{A}$
		$-40^\circ\text{C} \leq T_A \leq +85^\circ\text{C}$		50		$\mu\text{A}$
		$-40^\circ\text{C} \leq T_A \leq +125^\circ\text{C}$		0.5		$\text{nA}$
VCMR	Input Voltage Range		-0.1		5.1	V
CMRR	Common Mode Rejection Ratio	$V_{CM} = -0.1\text{ V to } +5.1\text{ V}$	100	140		dB
$A_{VO}$	Large Signal Voltage Gain	$V_O = 0.3\text{ V to } 4.7\text{ V}$ , $R_L = 10\text{ k}\Omega$	100	145		dB
		$-40^\circ\text{C} \leq T_A \leq +125^\circ\text{C}$		135		dB
$\Delta V_{OS}/\Delta T$	Offset Voltage Drift	$-40^\circ\text{C} \leq T_A \leq +125^\circ\text{C}$		0.01		$\mu\text{V}/^\circ\text{C}$
$V_{OH}$	Output Voltage High	$R_L = 10\text{ k}\Omega$ to GND		6	10	mV
$V_{OL}$	Output Voltage Low	$R_L = 100\text{ k}\Omega$ to V+		4		mV
$I_{SC}$	Output Short-Circuit Limit Current		$\pm 58$	$\pm 70$		mA
PSRR	Power Supply Rejection Ratio	$V_S = 2.7\text{ V to } 5\text{ V}$	100	120		dB
$I_{SY}$	Supply Current / Amplifier	$V_O = 0\text{ V}$		265	340	$\mu\text{A}$
		$-40^\circ\text{C} \leq T_A \leq +125^\circ\text{C}$		290		$\mu\text{A}$
SR	Slew Rate	$R_L = 10\text{ k}\Omega$		1.2		$\text{V}/\mu\text{s}$
Tor	Overload Recovery Time			150		$\mu\text{s}$
GBP	Gain-Bandwidth Product			1.8		MHz
$e_{n\text{ p-p}}$	Voltage Noise	0.1Hz to 10Hz		1.8		$\mu\text{V}_{P-P}$
$e_n$	Voltage Noise Density	f=1kHz		80		$\text{nV}/\sqrt{\text{Hz}}$

**Note:**

1. Stresses beyond those listed under Absolute Maximum Ratings may cause permanent damage to the device. Exposure to any Absolute Maximum Rating condition for extended periods may affect device reliability and lifetime.
2. A heat sink may be required to keep the junction temperature below the absolute maximum rating when the output is shorted indefinitely.
3. Thermal resistance varies with the amount of PC board metal connected to the package. The specified values are for short traces connected to the leads.

**Electronics Characteristics**
 $V_S = 2.5\text{ V}$ ,  $V_{CM} = 1.25\text{ V}$ ,  $V_O = 1.25\text{ V}$ ,  $T_A = 25^\circ\text{C}$ , unless otherwise noted.

Symbol	Parameter	Conditions	Min.	Typ.	Max.	Unit	
$V_{OS}$	Offset Voltage			3	14	$\mu\text{V}$	
$I_B$	Input Bias Current			4		$\text{pA}$	
		$-40^\circ\text{C} \leq T_A \leq +85^\circ\text{C}$		40		$\text{pA}$	
		$-40^\circ\text{C} \leq T_A \leq +125^\circ\text{C}$		0.2		$\text{nA}$	
$I_{OS}$	Input Offset Current			4		$\text{pA}$	
		WS72552	$-40^\circ\text{C} \leq T_A \leq +85^\circ\text{C}$		40		$\text{pA}$
		WS72552	$-40^\circ\text{C} \leq T_A \leq +125^\circ\text{C}$		0.2		$\text{nA}$
VCMR	Input Voltage Range		-0.1		2.6	V	
CMRR	Common Mode Rejection Ratio	$V_{CM}=0\text{ V to }+2.5\text{ V}$	100	140		$\text{dB}$	
		$-40^\circ\text{C} \leq T_A \leq +125^\circ\text{C}$				$\text{dB}$	
$A_{VO}$	Large Signal Voltage Gain	$V_O=0.3\text{ V to }2.2\text{ V}$ , $R_L=10\text{ k}\Omega$	100	140		$\text{dB}$	
$\Delta V_{OS}/\Delta T$	Offset Voltage Drift	$-40^\circ\text{C} \leq T_A \leq +125^\circ\text{C}$		0.008		$\mu\text{V}/^\circ\text{C}$	
$V_{OH}$	Output Voltage High	$R_L=10\text{ k}\Omega$ to GND		10		mV	
$V_{OL}$	Output Voltage Low	$R_L=10\text{ k}\Omega$ to $V^+$		10		mV	
$I_{SC}$	Output Short-Circuit Limit Current			$\pm 20$		$\text{mA}$	
PSRR	Power Supply Rejection Ratio	$V_S = 2.7\text{ V to }5\text{ V}$	100	120		$\text{dB}$	
$I_{SY}$	Supply Current / Amplifier	$V_O=0\text{ V}$		235	300	$\mu\text{A}$	
		$-40^\circ\text{C} \leq T_A \leq +125^\circ\text{C}$		260		$\mu\text{A}$	
SR	Slew Rate	$R_L=10\text{ k}\Omega$		1.2		$\text{V}/\mu\text{s}$	
	Overload Recovery Time			160		$\mu\text{s}$	
GBP	Gain-Bandwidth Product			1.7		$\text{MHz}$	
$e_{n\text{ p-p}}$	Voltage Noise	0Hz to 10Hz		1.8		$\mu\text{V}_{P-P}$	
$e_n$	Voltage Noise Density	$f=1\text{ kHz}$		80		$\text{nV}/\sqrt{\text{Hz}}$	

**Note:**

- Stresses beyond those listed under Absolute Maximum Ratings may cause permanent damage to the device. Exposure to any Absolute Maximum Rating condition for extended periods may affect device reliability and lifetime.
- A heat sink may be required to keep the junction temperature below the absolute maximum rating when the output is shorted indefinitely.
- Thermal resistance varies with the amount of PC board metal connected to the package. The specified values are for short traces connected to the leads.

## Typical Characteristics

$T_A=25^\circ\text{C}$ ,  $V_{CC}=5\text{V}$ ,  $R_L=10\text{K}$ ,  $C_L=100\text{pF}$ , unless otherwise noted.

**Small-Signal Step Response, 100mV Step**

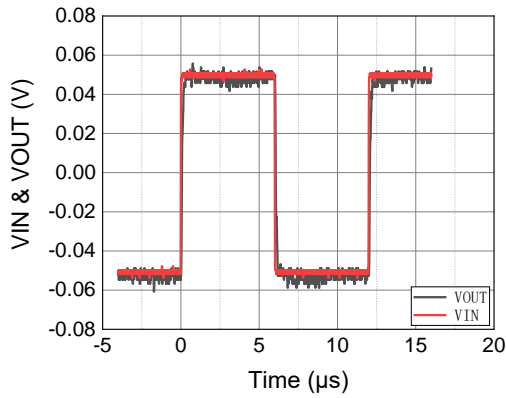

**Large-Signal Step Response, 2V Step**

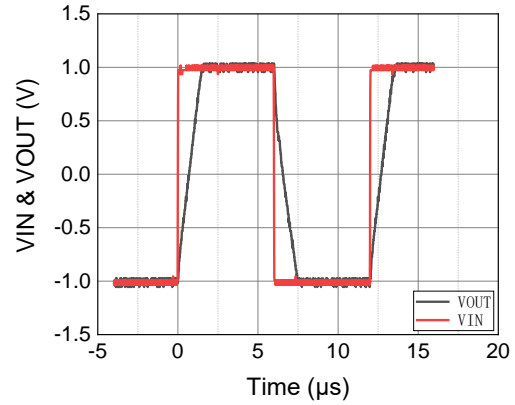

**Open-Loop Gain and Phase**

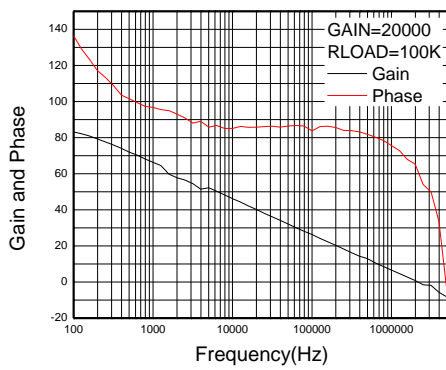

**Load vs. Phase Margin**

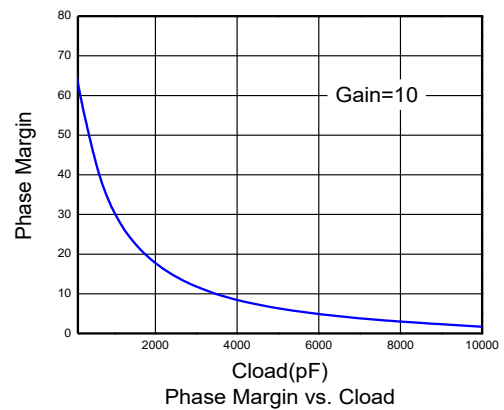

**Input Offset Voltage vs. Temperature**

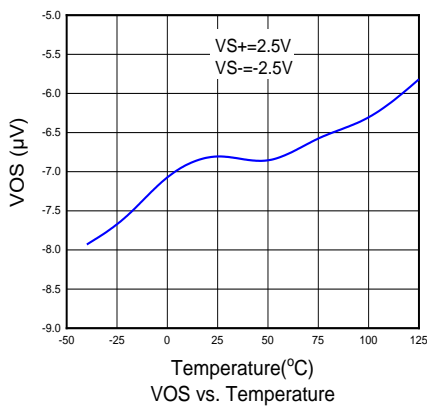

**Iq vs. Supply Voltage**

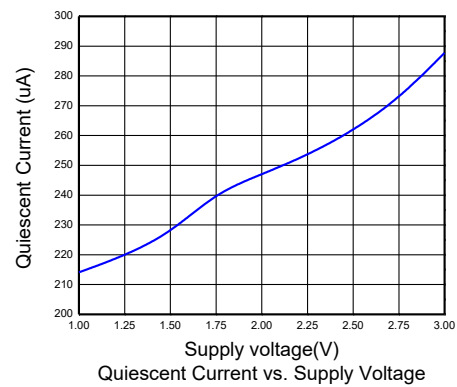

**Typical Characteristics (continued)**
 $T_A=25\text{ }^\circ\text{C}$ ,  $V_{CC}=5\text{V}$ ,  $R_L=10\text{K}$ ,  $C_L=100\text{pF}$ , unless otherwise noted.

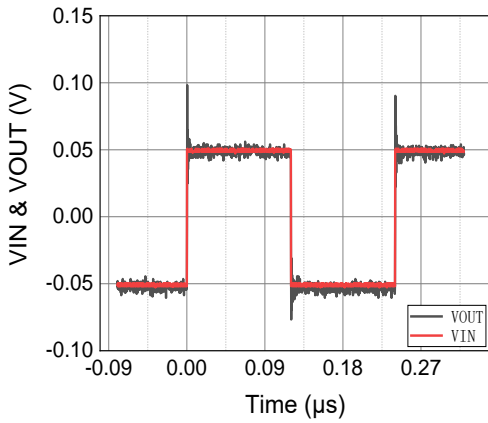
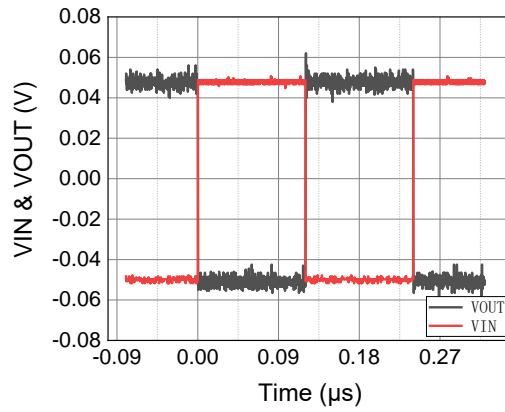
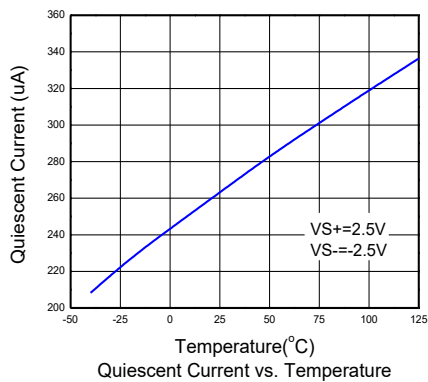
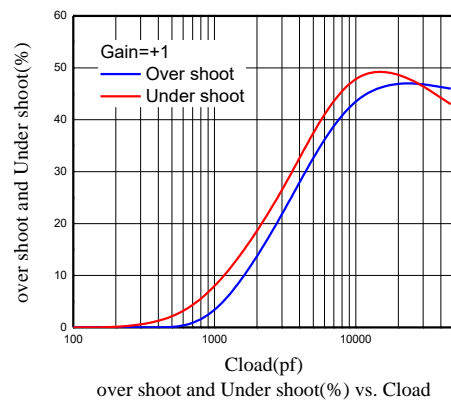
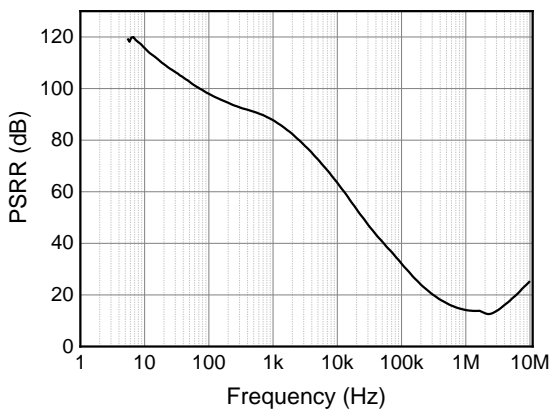
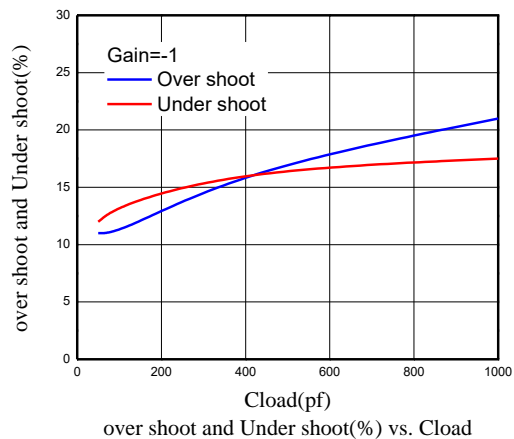
**Over Shoot Voltage,  $C_{LOAD}=47\text{nF}$ ,  
 $R_{LOAD}=10\text{k}\Omega$ , Gain=+1**

**Over Shoot Voltage,  $C_{LOAD}=47\text{nF}$ ,  
 $R_F=2\text{k}\Omega$ , Gain=-1**

**Iq vs. Temperature**

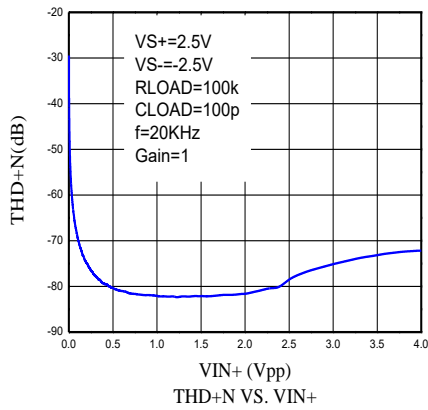
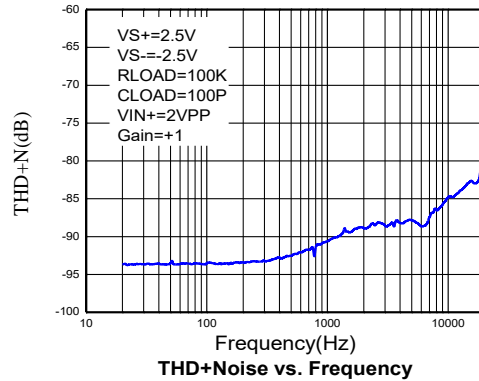
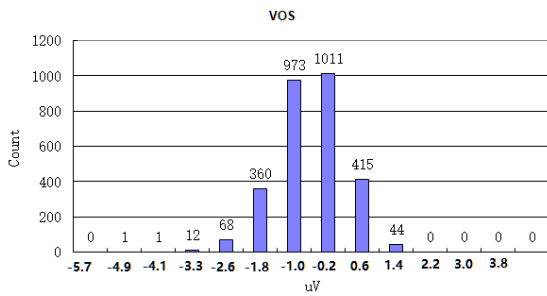
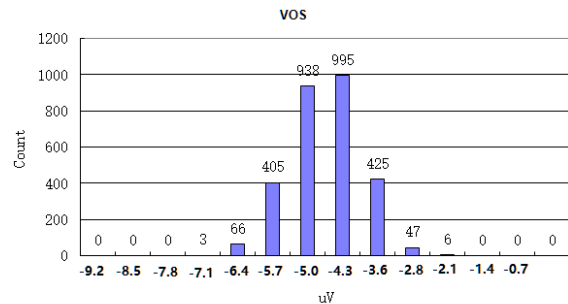
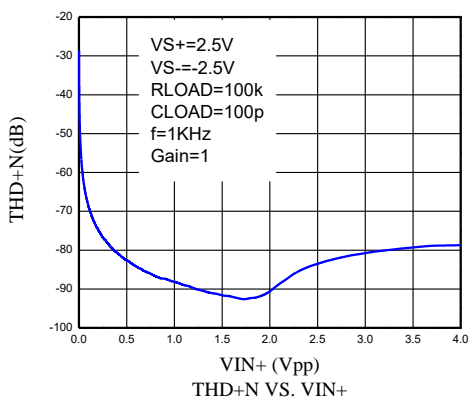
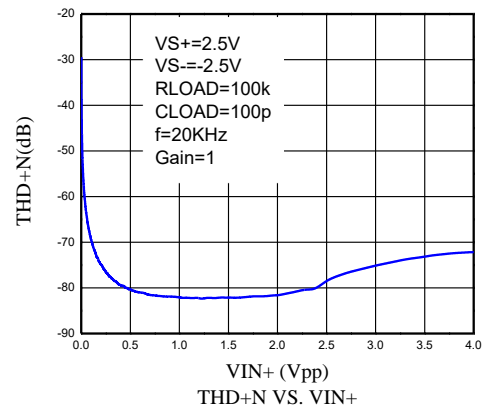
**Over/under shoot vs. Clload**

**PSRR vs. Frequency**

**Over/under shoot vs. Clload**



**Typical Characteristics (continued)**
 $T_A=25^\circ\text{C}$ ,  $V_{CC}=5\text{V}$ ,  $R_L=10\text{K}$ ,  $C_L=100\text{pF}$ , unless otherwise noted.

**THD+N vs. Vin F=20KHz**

**THD+N vs. Frequency**

**Input Offset Voltage Distribution (VS+=2.5V)**

**Input Offset Voltage Distribution (VS+=5V)**

**THD+Noise vs. Vin+, Gain=+1, f=1kHz,**
 $R_{LOAD}=100\text{k}\Omega$ ,  $C_{LOAD}=100\text{pF}$ 

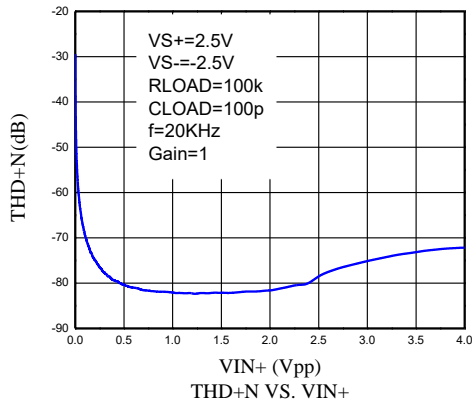
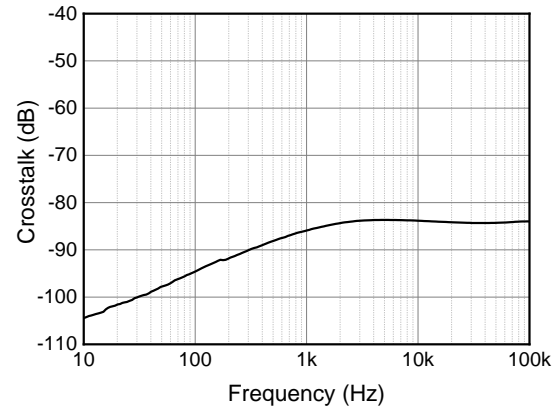
**THD+Noise vs. Vin+, Gain=100, f=20kHz,**
 $R_{LOAD}=100\text{k}\Omega$ ,  $C_{LOAD}=100\text{pF}$ 

**Typical Characteristics (continued)**

$T_A=25\text{ }^\circ\text{C}$ ,  $V_{CC}=5\text{V}$ ,  $R_L=10\text{K}$ ,  $C_L=100\text{pF}$ , unless otherwise noted.

**THD+Noise vs. Frequency, Gain=+1,**

$V_{in+}=2V_{pp}$   $R_{LOAD}=100\text{k}\Omega$ ,  $C_{LOAD}=100\text{pF}$

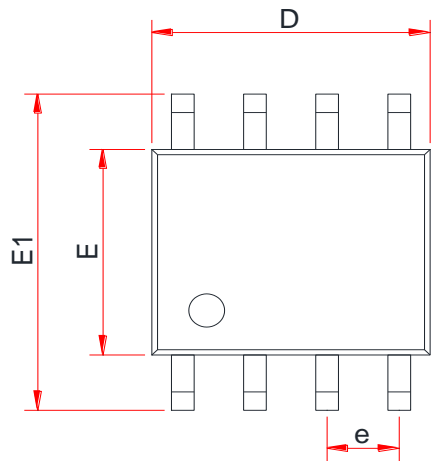
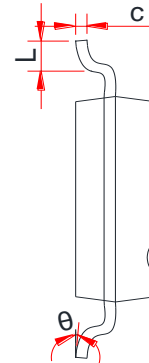
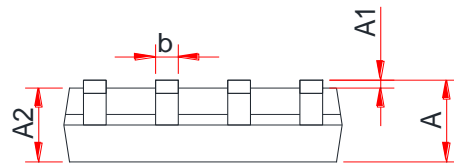

**Crosstalk, (WS72552 only)**

**PACKAGE OUTLINE DIMENSIONS**
**SOP-8L**

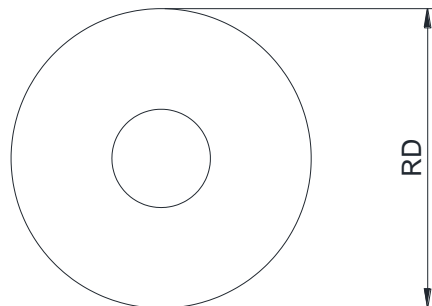
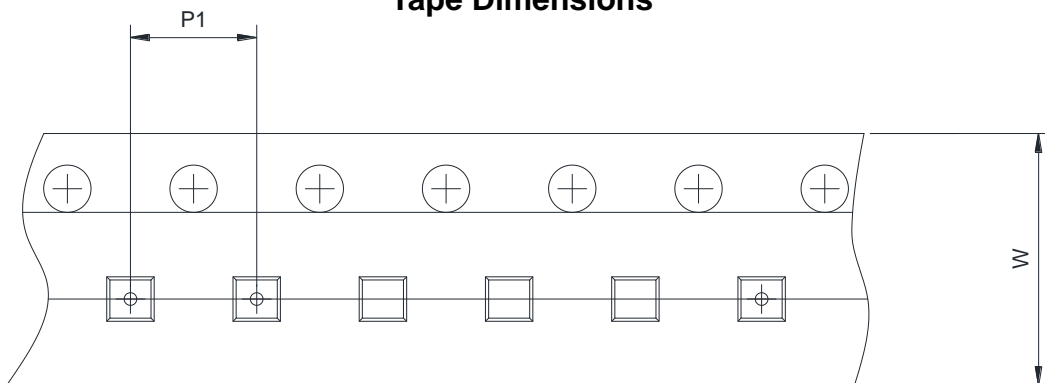
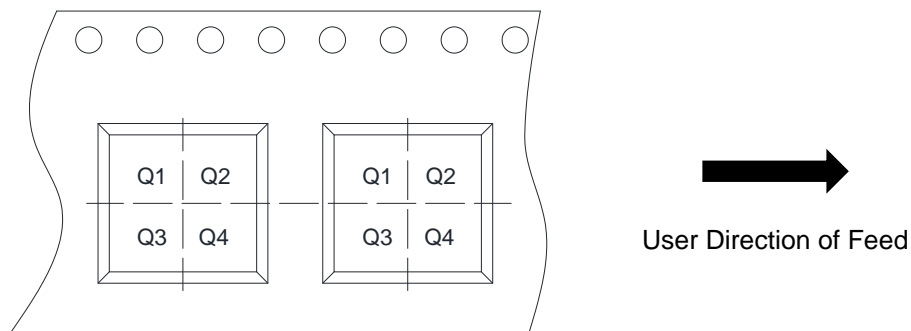
**TOP VIEW**

**SIDE VIEW**

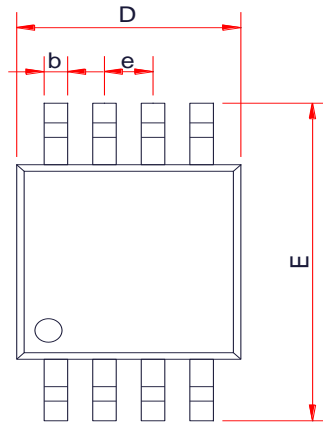
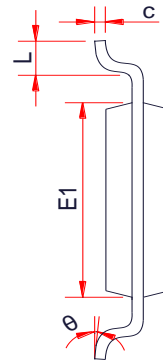
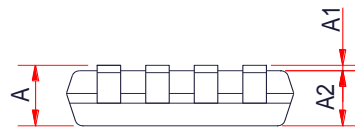
**SIDE VIEW**

Symbol	Dimensions In Millimeters (mm)		
	Min.	Typ.	Max.
A	1.35	1.55	1.75
A1	0.05	0.15	0.25
A2	1.25	1.40	1.65
b	0.33	-	0.51
c	0.15	-	0.26
D	4.70	4.90	5.10
E	3.70	3.90	4.10
E1	5.80	6.00	6.20
e	1.27BSC		
L	0.40	-	1.27
$\theta$	0°	-	8°

**TAPE AND REEL INFORMATION**
**SOP-8L**
**Reel Dimensions**

**Tape Dimensions**

**Quadrant Assignments For PIN1 Orientation In Tape**

RD	Reel Dimension	<input type="checkbox"/> 7inch	<input checked="" type="checkbox"/> 13inch		
W	Overall width of the carrier tape	<input type="checkbox"/> 8mm	<input checked="" type="checkbox"/> 12mm		
P1	Pitch between successive cavity centers	<input type="checkbox"/> 2mm	<input type="checkbox"/> 4mm	<input checked="" type="checkbox"/> 8mm	
Pin1	Pin1 Quadrant	<input checked="" type="checkbox"/> Q1	<input type="checkbox"/> Q2	<input type="checkbox"/> Q3	<input type="checkbox"/> Q4

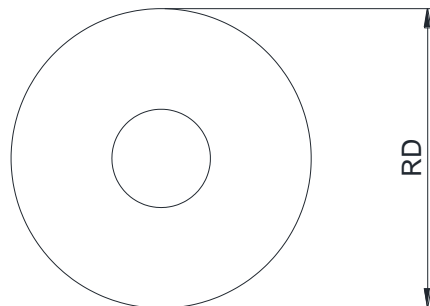
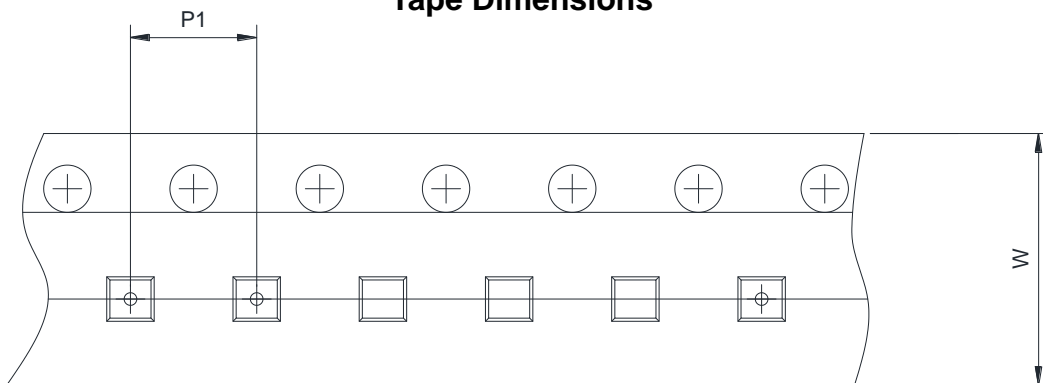
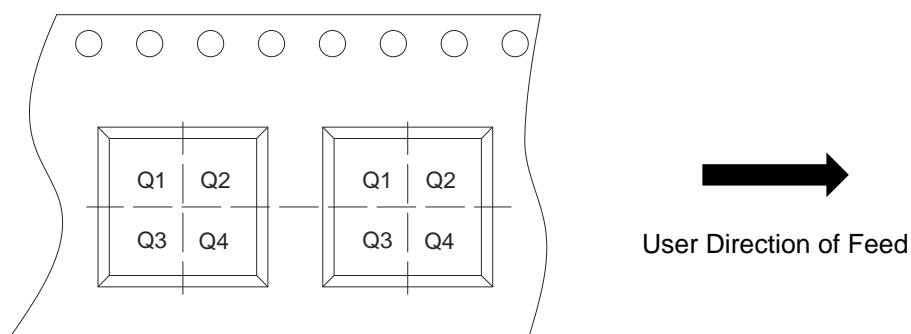
**PACKAGE OUTLINE DIMENSIONS**
**MSOP-8L**

**TOP VIEW**

**SIDE VIEW**

**SIDE VIEW**

Symbol	Dimensions In Millimeters (mm)		
	Min.	Typ.	Max.
A	-	-	1.10
A1	0.02	-	0.15
A2	0.75	0.80	0.95
b	0.25	-	0.38
c	0.09	-	0.23
D	2.90	3.00	3.10
E	4.75	4.90	5.05
E1	2.90	3.00	3.10
e	0.65 BSC		
L	0.40	-	0.80
θ	0°	-	6°

**TAPE AND REEL INFORMATION**
**MSOP-8L**
**Reel Dimensions**

**Tape Dimensions**

**Quadrant Assignments For PIN1 Orientation In Tape**

RD	Reel Dimension	<input type="checkbox"/> 7inch	<input checked="" type="checkbox"/> 13inch		
W	Overall width of the carrier tape	<input type="checkbox"/> 8mm	<input checked="" type="checkbox"/> 12mm		
P1	Pitch between successive cavity centers	<input type="checkbox"/> 2mm	<input type="checkbox"/> 4mm	<input checked="" type="checkbox"/> 8mm	
Pin1	Pin1 Quadrant	<input checked="" type="checkbox"/> Q1	<input type="checkbox"/> Q2	<input type="checkbox"/> Q3	<input type="checkbox"/> Q4

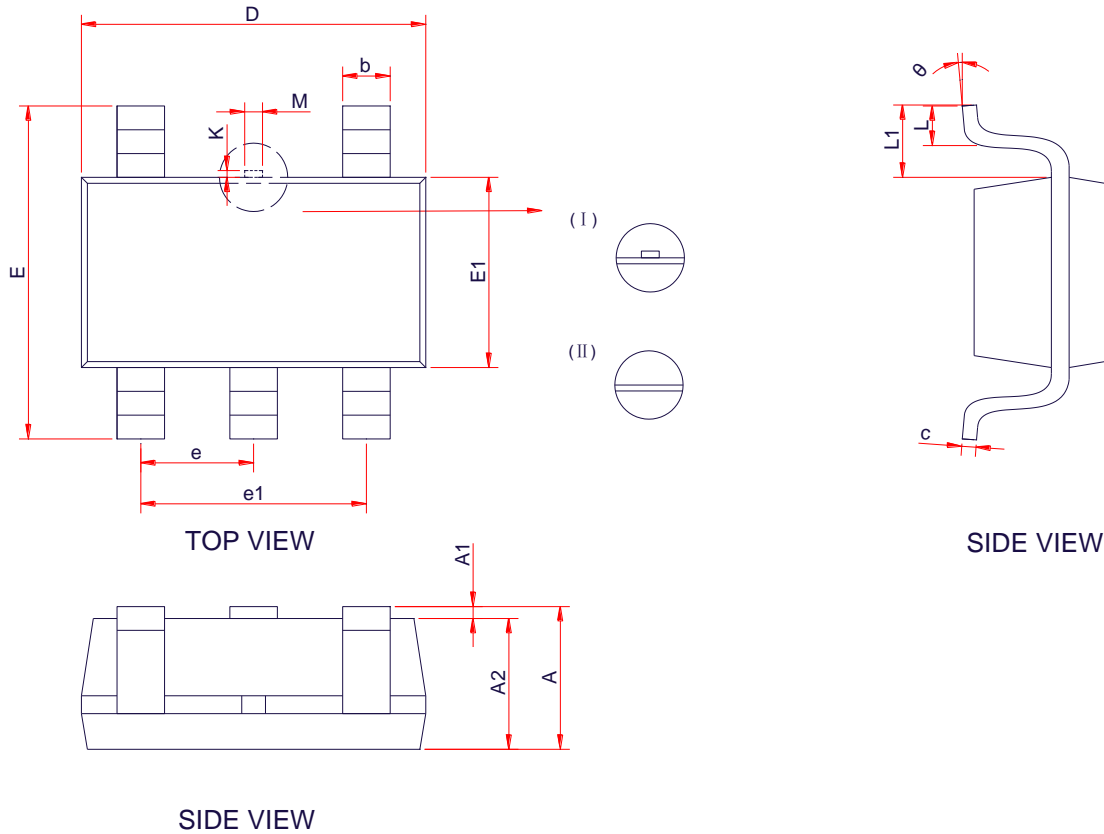
**PACKAGE OUTLINE DIMENSIONS**
**SOT23-5L**

(WS72551EA-5/TR)



Symbol	Dimensions in Millimeters		
	Min.	Typ.	Max.
A	-	-	1.45
A1	0.00	-	0.15
A2	0.90	1.10	1.30
b	0.30	0.40	0.50
c	0.10	-	0.21
D	2.72	2.92	3.12
E	2.60	2.80	3.00
E1	1.40	1.60	1.80
e	0.95 BSC		
e1	1.90 BSC		
L	0.30	0.45	0.60
M	0.10	0.15	0.25
K	0.00	-	0.25
$\theta$	0°	-	8°

**TAPE AND REEL INFORMATION**
**SOT23-5L**  
 (WS72551EA-5/TR)

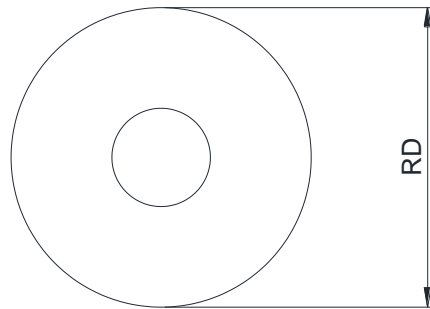
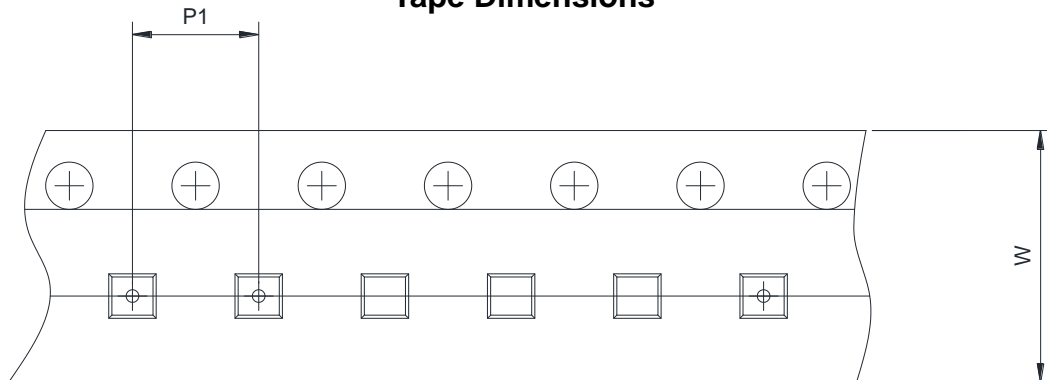
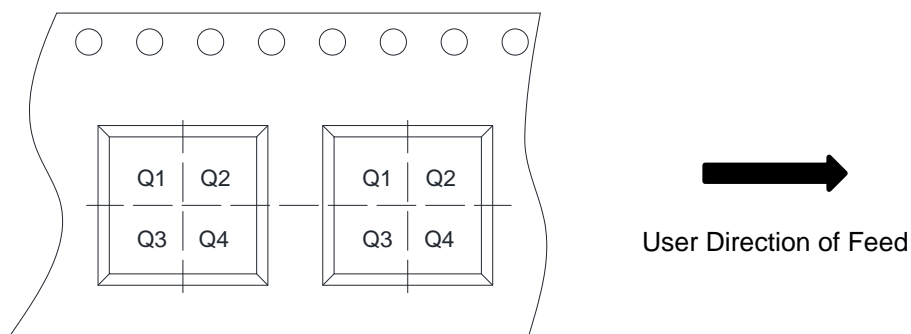
**Reel Dimensions**

**Tape Dimensions**

**Quadrant Assignments For PIN1 Orientation In Tape**

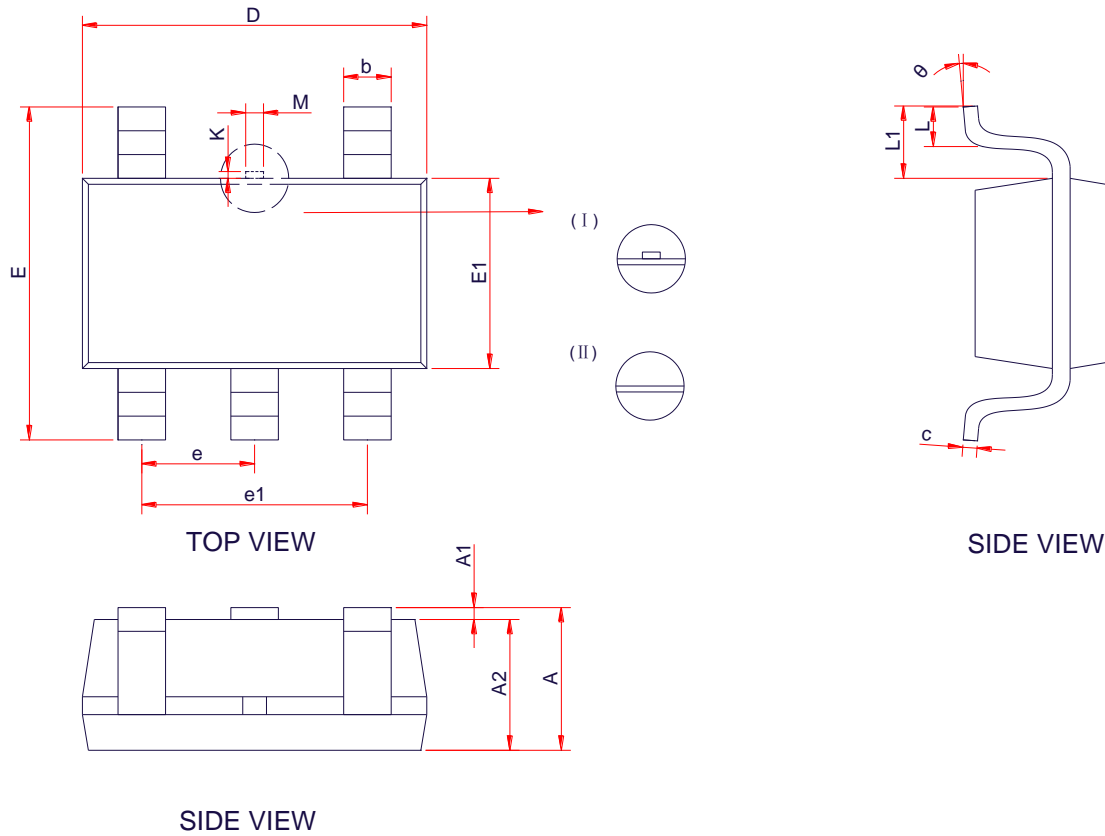
RD	Reel Dimension	<input checked="" type="checkbox"/> 7inch	<input type="checkbox"/> 13inch
W	Overall width of the carrier tape	<input checked="" type="checkbox"/> 8mm	<input type="checkbox"/> 12mm <input type="checkbox"/> 16mm
P1	Pitch between successive cavity centers	<input type="checkbox"/> 2mm	<input checked="" type="checkbox"/> 4mm <input type="checkbox"/> 8mm
Pin1	Pin1 Quadrant	<input type="checkbox"/> Q1	<input type="checkbox"/> Q2 <input checked="" type="checkbox"/> Q3 <input type="checkbox"/> Q4



**PACKAGE OUTLINE DIMENSIONS**
**SOT23-5L**  
**(WS72551E-5/TR)**

Symbol	Dimensions in Millimeters		
	Min.	Typ.	Max.
A	-	-	1.25
A1	0.00	-	0.15
A2	1.00	1.10	1.20
b	0.36	-	0.45
c	0.14	-	0.20
D	2.826	2.926	3.026
E	2.60	2.80	3.00
E1	1.526	1.626	1.726
e	0.90	0.95	1.00
e1	1.80	1.90	2.00
L	0.30	0.40	0.60
M	0.10	0.15	0.25
K	0.00	-	0.25
$\theta$	0°	-	8°

**TAPE AND REEL INFORMATION**
**SOT23-5L**  
 (WS72551E-5/TR)

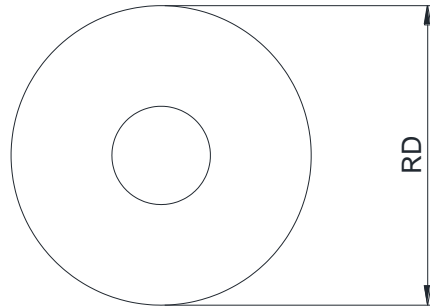
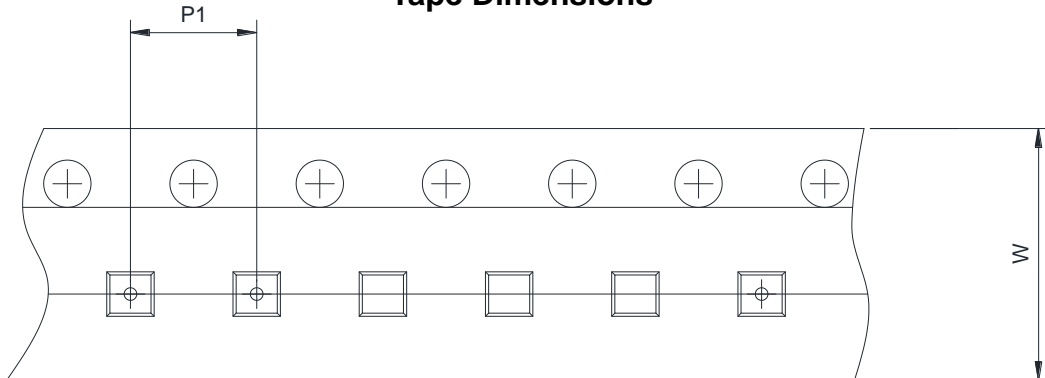
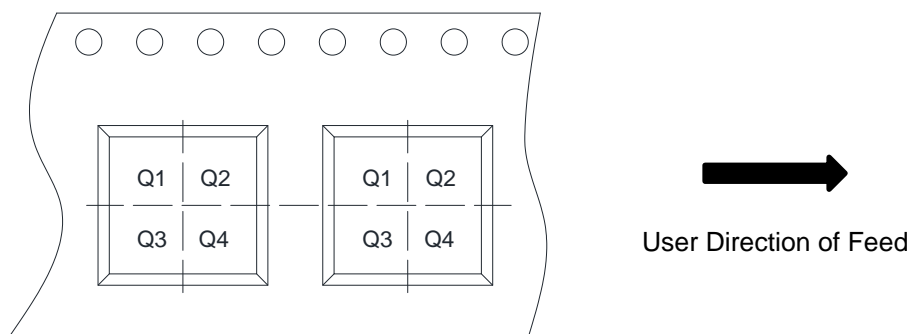
**Reel Dimensions**

**Tape Dimensions**

**Quadrant Assignments For PIN1 Orientation In Tape**

RD	Reel Dimension	<input checked="" type="checkbox"/> 7inch	<input type="checkbox"/> 13inch
W	Overall width of the carrier tape	<input checked="" type="checkbox"/> 8mm	<input type="checkbox"/> 12mm <input type="checkbox"/> 16mm
P1	Pitch between successive cavity centers	<input type="checkbox"/> 2mm	<input checked="" type="checkbox"/> 4mm <input type="checkbox"/> 8mm
Pin1	Pin1 Quadrant	<input type="checkbox"/> Q1	<input type="checkbox"/> Q2 <input checked="" type="checkbox"/> Q3 <input type="checkbox"/> Q4

## X-ON Electronics

Largest Supplier of Electrical and Electronic Components

*Click to view similar products for [Operational Amplifiers - Op Amps](#) category:*

*Click to view products by [Will Semiconductor](#) manufacturer:*

Other Similar products are found below :

[OPA2991IDSGR](#) [OPA607IDCKT](#) [007614D](#) [633773R](#) [635798C](#) [635801A](#) [702115D](#) [709228FB](#) [741528D](#) [NCV33072ADR2G](#)  
[SC2902DTBR2G](#) [SC2903DR2G](#) [SC2903VDR2G](#) [LM258AYDT](#) [LM358SNG](#) [430227FB](#) [430228DB](#) [460932C](#) [AZV831KTR-G1](#) [409256CB](#)  
[430232AB](#) [LM2904DR2GH](#) [LM358YDT](#) [LT1678IS8](#) [042225DB](#) [058184EB](#) [070530X](#) [SC224DR2G](#) [SC239DR2G](#) [SC2902DG](#)  
[SCYA5230DR2G](#) [714228XB](#) [714846BB](#) [873836HB](#) [MIC918YC5-TR](#) [TS912BIYDT](#) [NCS2004MUTAG](#) [NCV33202DMR2G](#)  
[M38510/13101BPA](#) [NTE925](#) [SC2904DR2G](#) [SC358DR2G](#) [LM358EDR2G](#) [AZV358MTR-G1](#) [AP4310AUMTR-AG1](#) [HA1630D02MMEL-E](#)  
[NJM358CG-TE2](#) [HA1630S01LPEL-E](#) [LM324AWPT](#) [HA1630Q06TELL-E](#)