

WS726052

High Precision, Low Noise Operational Amplifiers

[Http://www.omnivision-group.com](http://www.omnivision-group.com)

Descriptions

The WS726052 a dual high output drive CMOS operational amplifiers featured a peak output current of 350mA, and rail-to-rail output capability from a single 2.5V to 5.5V supply. This amplifier exhibits a high slew rate of 6V/μs and a gain-bandwidth product (GBP) of 11.5MHz. The WS726052 can drive typical headset levels (32Ω), as well as bias an RF power amplifier in wireless handset applications.

The WS726052 is available with MSL 3 Level in MSOP-8L package and MSL 2 Level in DFN2x2-8 package. Standard products are Pb-Free and halogen-Free.

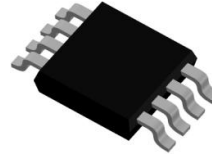

MSOP-8L

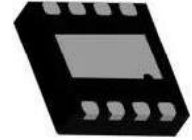

DFN2x2-8

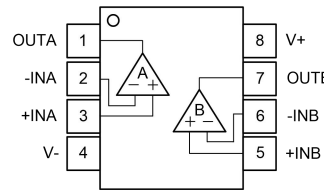

MSOP-8L

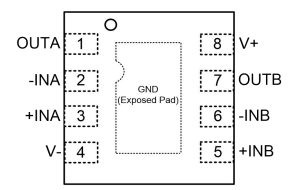

DFN2x2-8

Pin configuration (Top view)

Applications

- RF Power Amplifier Biasing Controls
- Portable/Battery-Powered Audio Applications
- Portable Headphone Speaker Drivers (32Ω)
- Audio Hands-Free Car Phones (Kits)
- Laptop/Notebook Computers/TFT Panels
- Set-Top Boxes
- Digital-to-Analog Converter Buffers
- Transformer/Line Drivers

Features

- 350mA Output Drive Capability
- Low Input Offset Voltage: 5μV (MAX)
- Low Noise: 40nV/ Hz at 1kHz
- 300mA Current Limitation
- Over-Temperature Protection
- Supply Voltage Range: 2.5V to 5.5V
- Supply Current: 0.95mA/Amplifier (TYP)
- Gain-Bandwidth Product: 11.5MHz
- High Slew Rate: 6V/μs
- Voltage Gain (RL = 2kΩ): 140dB
- Power Supply Rejection Ratio: 135dB
- No Phase Reversal for Over-Driven Inputs
- Unity-Gain Stable for Capacitive Loads to 780pF



MSOP-8L

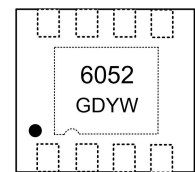

DFN2x2-8

Marking

- 6052 = Device code
- GM = Special code
- GD = Special code
- Y = Year code
- W = Week code

Order Information

Device	Package	Shipping
WS726052M-8/TR	MSOP-8L	4000/Reel &Tape
WS726052D-8/TR	DFN2x2-8	3000/Reel &Tape

Pin Descriptions

Pin Number	Symbol	Descriptions
1	OUTA	Output of Channel A
2	-INA	Inverting input of Channel A
3	+INA	Non-inverting input of Channel A
4	V-	Negative supply
5	+INB	Non-inverting input of Channel B
6	-INB	Inverting input of Channel B
7	OUTB	Output of Channel B
8	V+	Positive supply

Absolute Maximum Ratings

Parameter	Symbol	Value	Unit
Supply Voltage, ([V+] - [V-])	$V_S^{(2)}$	5.5	V
Operating Supply Voltage Range	V_{IDR}	2.5 to 5.5	V
All Other Pins	V_{ICR}	(V-)-0.3 to (V+)+0.3	V
Operating Free-Air Temperature Range	T_A	-40 to 125	°C
Storage Temperature Range	T_{STG}	-65 to 150	°C
Junction Temperature Range	T_J	150	°C
Lead Temperature Range	T_L	260	°C

Note:

- Stresses beyond those listed under Absolute Maximum Ratings may cause permanent damage to the device. These are only stress ratings, and functional operation of the device at these or any other conditions beyond those indicated under recommended operating conditions are not implied. Exposure to absolute-maximum-rated conditions for extended periods may affect device reliability.
- All voltage values, except differential voltage are with respect to network terminal.

ESD, Electrostatic Discharge Protection

Symbol	Parameter	Condition	Minimum level	Unit
HBM	Human Body Model ESD	MIL-STD-883H Method 3015.8 JEDEC-EIA/JESD22-A114A	±8000	V
MM	Machine Model ESD	JEDEC-EIA/JESD22-A115	±400	V
CDM	Charged Device Model ESD	JEDEC-EIA/JESD22-C101E	±2000	V

Note:

This integrated circuit can be damaged by ESD if you don't pay attention to ESD protection. Will Semiconductor Ltd. recommends that all integrated circuits be handled with appropriate precautions. Failure to observe proper handling and installation procedures can cause damage. ESD damage can range from subtle performance degradation to complete device failure. Precision integrated circuits may be more susceptible to damage because very small parametric changes could cause the device not to meet its published specifications.

Electronics Characteristics

The *denotes the specifications which apply over the full operating temperature range, otherwise specifications are at $T_A = 25^\circ\text{C}$, $V_S = 5\text{V}$, $V_{\text{CM}} = V_{\text{OUT}} = V_S/2$, $R_{\text{load}} = 2\text{k}\Omega$, $C_{\text{load}} = 20\text{pF}$.

Symbol	PARAMETER	CONDITIONS	MIN	TYP	MAX	UNITS
INPUT CHARACTERISTICS						
V_{OS}	Input Offset Voltage			1	5	μV
V_{CM}	Input Common Mode Voltage Range		(V-) - 0.1		(V+) + 0.1	V
CMRR	Common Mode Rejection Ratio	$(V-) - 0.1\text{V} < V_{\text{CM}} < (V+) + 0.1\text{V}$	120	135		dB
A_{OL}	Open-Loop Voltage Gain	$(V-) + 0.1\text{V} < V_{\text{OUT}} < (V+) - 0.1\text{V}$, $R_{\text{load}} = 2\text{k}\Omega$	120	140		dB
OUTPUT CHARACTERISTICS						
V_{OH}	Output Voltage Swing from Rail to V+	$R_{\text{load}} = 150\Omega$		72	85	mV
V_{OL}	Output Voltage Swing from Rail to V-	$R_{\text{load}} = 150\Omega$		112	125	mV
$I_{\text{SC+}}$	Output Short-Circuit Current to V+		315	342		mA
$I_{\text{SC-}}$	Output Short-Circuit Current to V-		275	295		
POWER SUPPLY						
V_S	Specified Voltage Range		2.5		5.5	V
I_Q	Quiescent Current/Amplifier	$I_{\text{OUT}} = 0$		827	1300	μA
PSRR	Power Supply Rejection Ratio	$V_+ = 2.5\text{V to } 5.5\text{V}$, $V_{\text{CM}} = V_+/2\text{V}$	120	135		dB
DYNAMIC PERFORMANCE						
	Gain-Bandwidth Product	$G = +100$, $C_{\text{load}} = 20\text{pF}$		11.5		MHz
	Slew Rate	$G = +1$, $V_{\text{OUT}} = 2V_{\text{P-P}}$		6		V/ μs
NOISE						
	Input Voltage Noise	$f = 0.1\text{Hz to } 10\text{Hz}$		0.8		$\mu\text{V}_{\text{P-P}}$
	Input Voltage Noise Density	$f = 1\text{kHz}$		40		nV/ $\sqrt{\text{Hz}}$
		$f = 10\text{kHz}$		8		

Note:

- Stresses beyond those listed under Absolute Maximum Ratings may cause permanent damage to the device. Exposure to any Absolute Maximum Rating condition for extended periods may affect device reliability and lifetime.
- A heat sink may be required to keep the junction temperature below the absolute maximum rating when the output is shorted indefinitely.

Typical Characteristics

At $T_A=25^{\circ}\text{C}$, $V_S=\pm 2.5\text{V}$, $V_{CM}=0\text{V}$, $R_{load}=2\text{k}\Omega$, $C_{load}=20\text{pF}$, unless otherwise noted.

Small - signal Step Response, 100mV Step

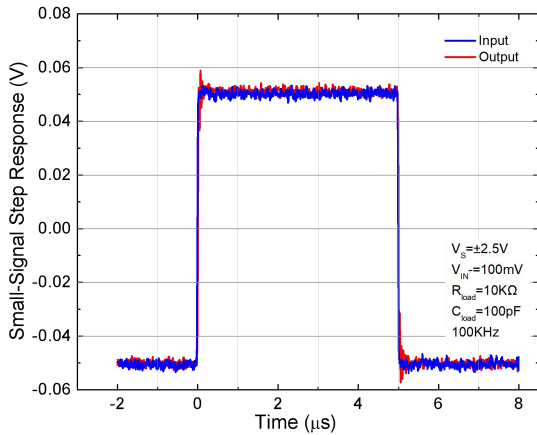

Large - Signal Step Response, 2V Step

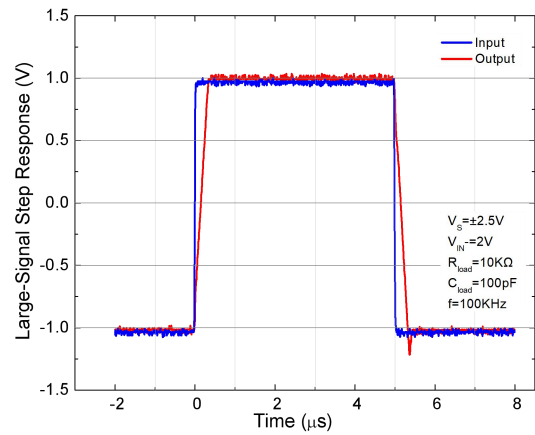

Over Shoot Voltage

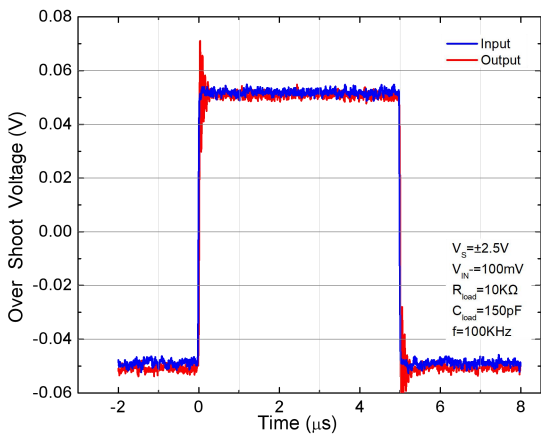

Large-Signal Step Response2, 2V Step

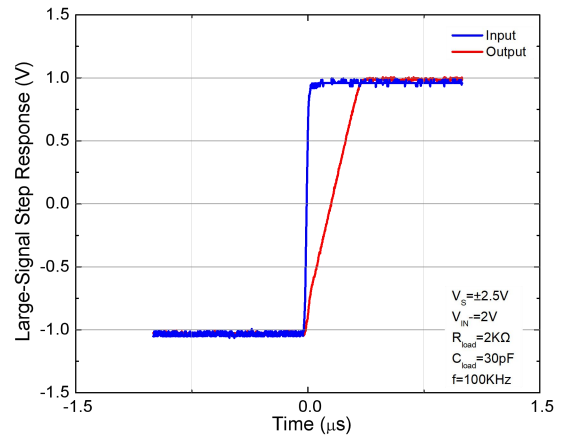

Open-Loop Gain

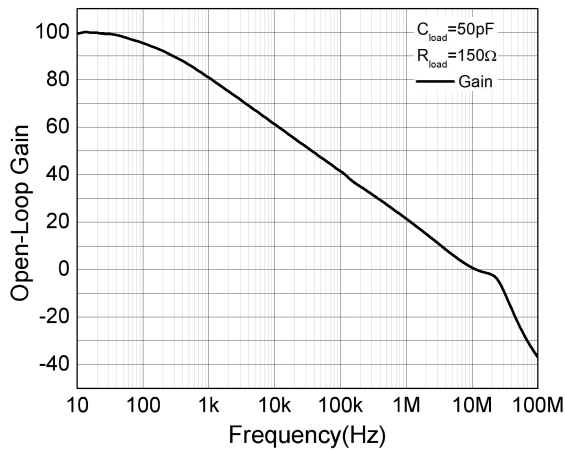

Open-Loop Gain and Phase

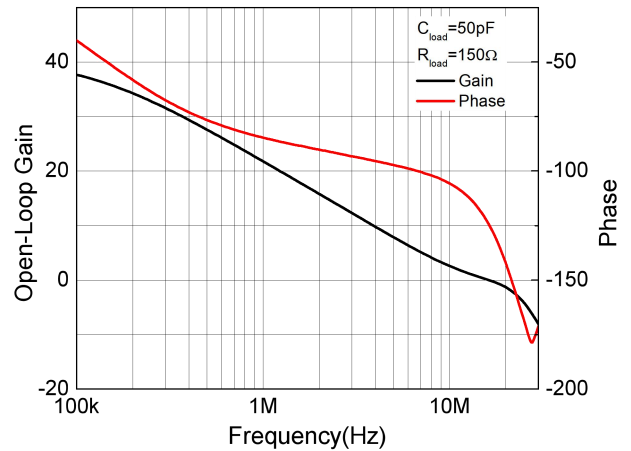

Typical Characteristics (continued)

$T_A=25^\circ\text{C}$, $V_S=\pm 2.5\text{V}$, $V_{CM}=0\text{V}$, $R_{load}=2\text{k}\Omega$, $C_{load}=20\text{pF}$, unless otherwise noted.

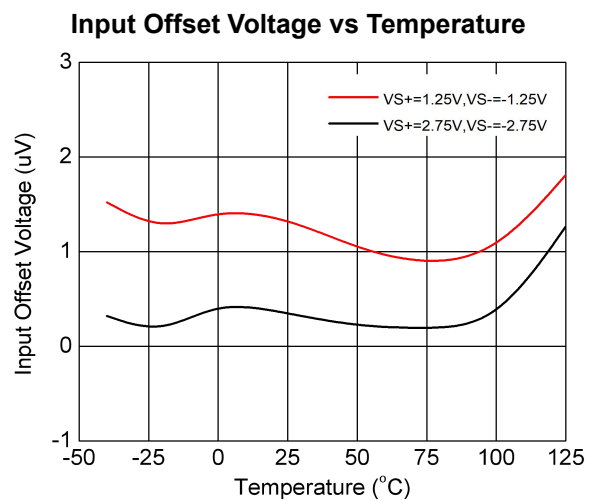
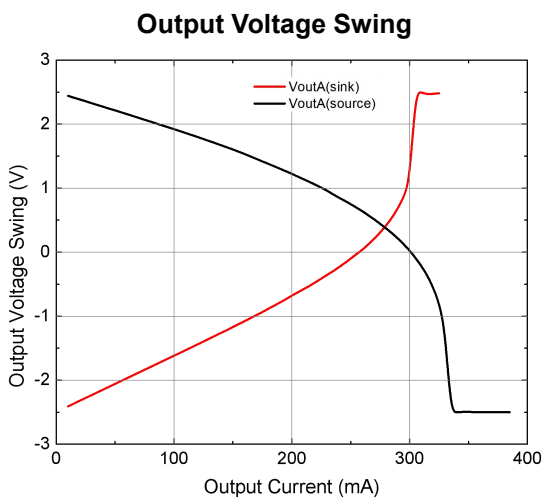
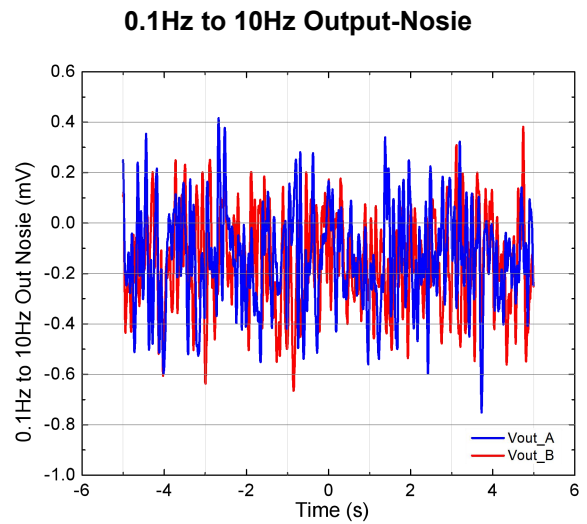
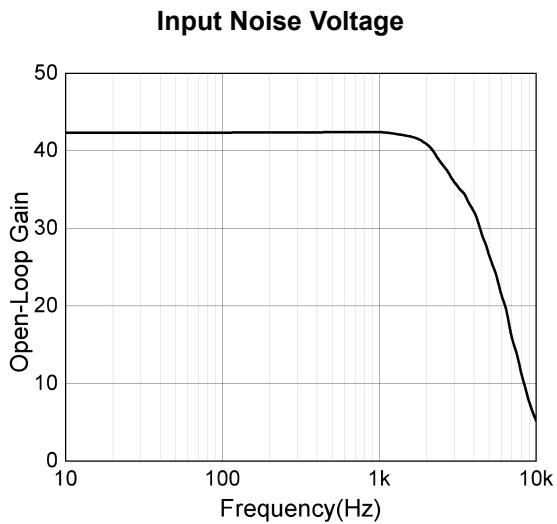
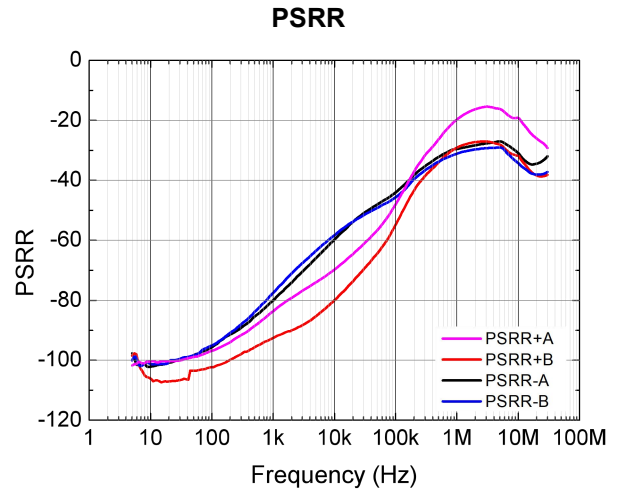
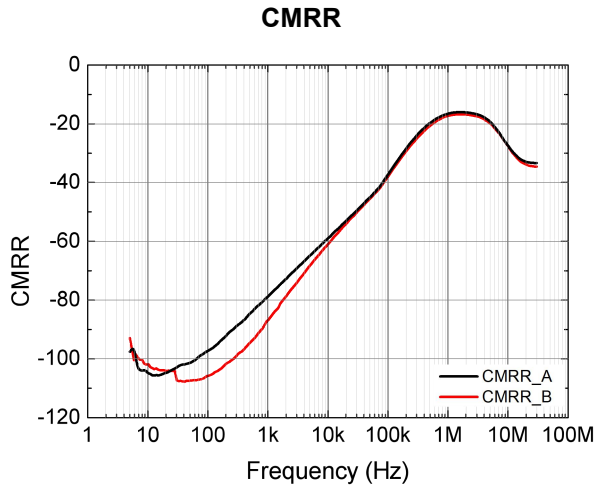

Typical Characteristics (continued)

$T_A=25^{\circ}\text{C}$, $V_S=\pm 2.5\text{V}$, $V_{CM}=0\text{V}$, $R_{load}=2\text{k}\Omega$, $C_{load}=20\text{pF}$, unless otherwise noted.

High Output Voltage vs Temperature

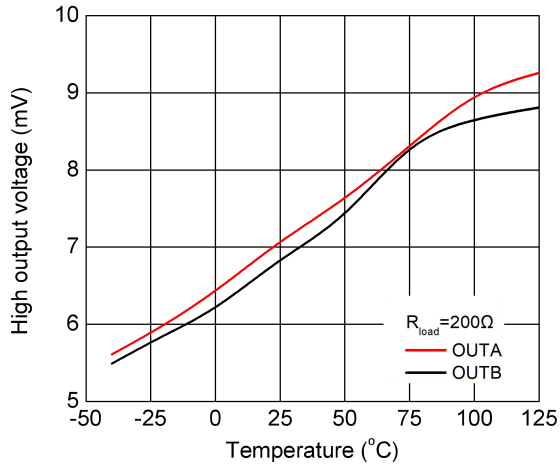

Low Output Voltage vs Temperature

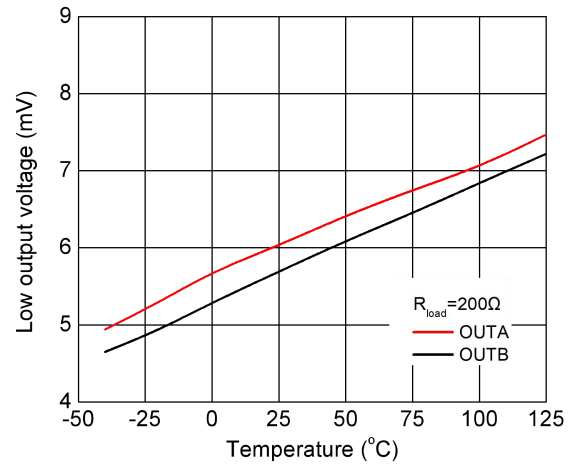

Slew Rate rising vs Temperature

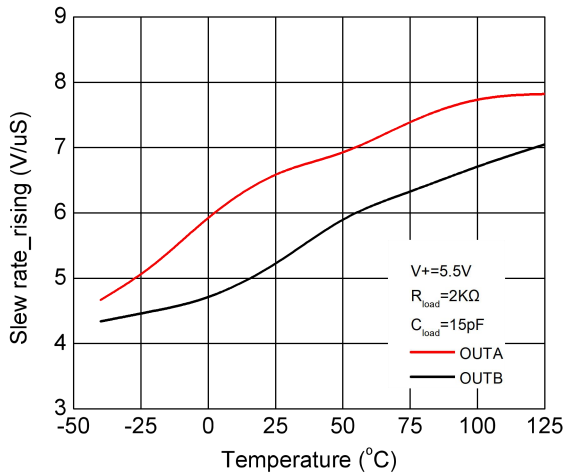

Slew Rate falling vs Temperature

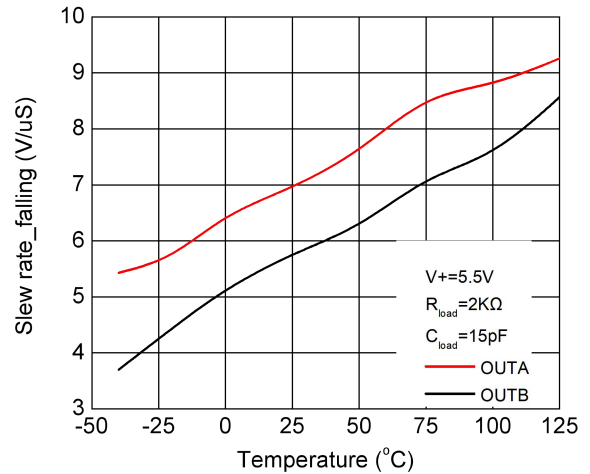

Total Supply Current vs Temperature

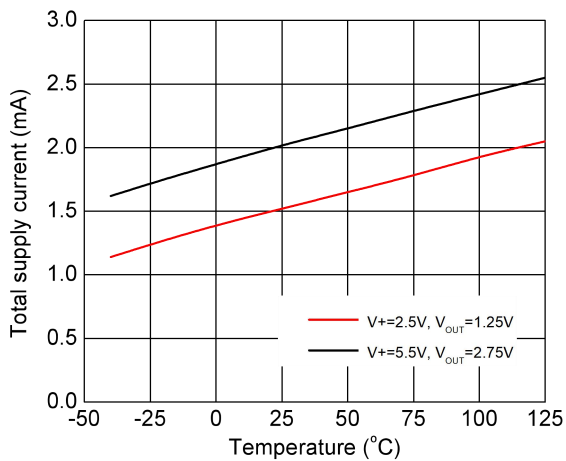

PACKAGE OUTLINE DIMENSIONS

MSOP-8L

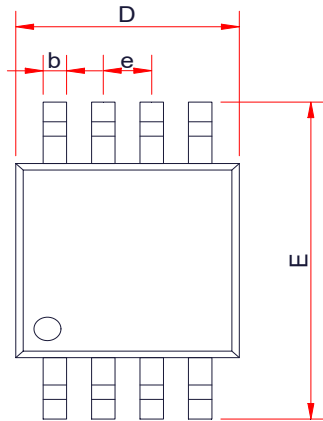

TOP VIEW

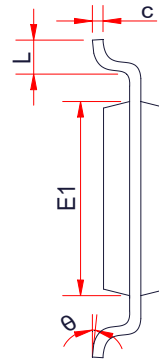

SIDE VIEW

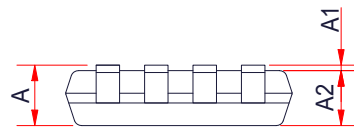

SIDE VIEW

Symbol	Dimensions In Millimeters (mm)		
	Min.	Typ.	Max.
A	-	-	1.10
A1	0.02	-	0.15
A2	0.75	0.80	0.95
b	0.25	-	0.38
c	0.09	-	0.23
D	2.90	3.00	3.10
E	4.75	4.90	5.05
E1	2.90	3.00	3.10
e	0.65 BSC		
L	0.40	-	0.80
θ	0°	-	6°

TAPE AND REEL INFORMATION

MSOP-8L

Reel Dimensions

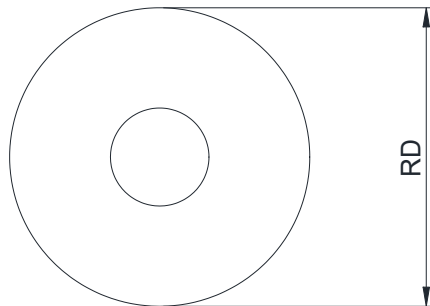

Tape Dimensions

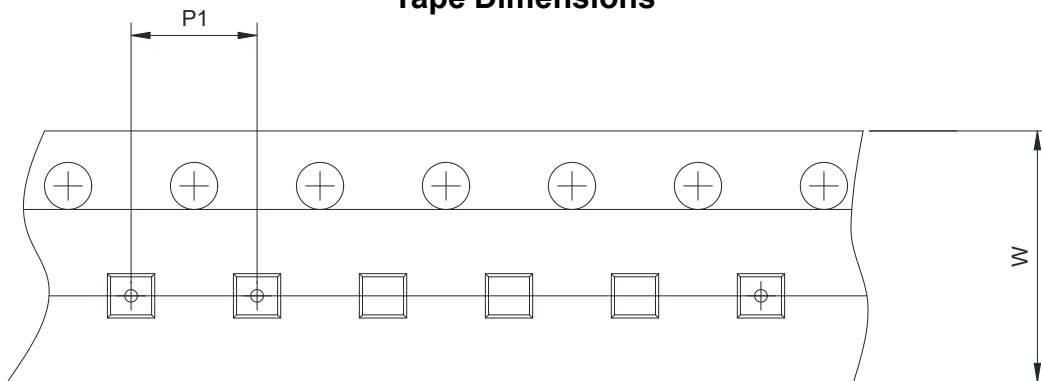

Quadrant Assignments For PIN1 Orientation In Tape

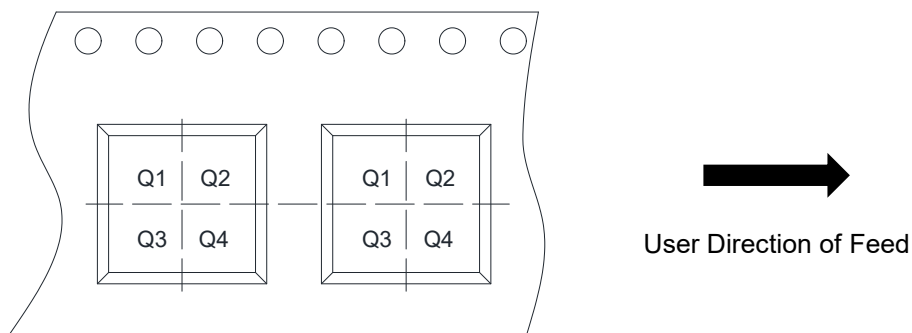

RD	Reel Dimension	<input type="checkbox"/> 7inch	<input checked="" type="checkbox"/> 13inch		
W	Overall width of the carrier tape	<input type="checkbox"/> 8mm	<input checked="" type="checkbox"/> 12mm		
P1	Pitch between successive cavity centers	<input type="checkbox"/> 2mm	<input type="checkbox"/> 4mm	<input checked="" type="checkbox"/> 8mm	
Pin1	Pin1 Quadrant	<input checked="" type="checkbox"/> Q1	<input type="checkbox"/> Q2	<input type="checkbox"/> Q3	<input type="checkbox"/> Q4

PACKAGE OUTLINE DIMENSIONS

DFN2×2-8

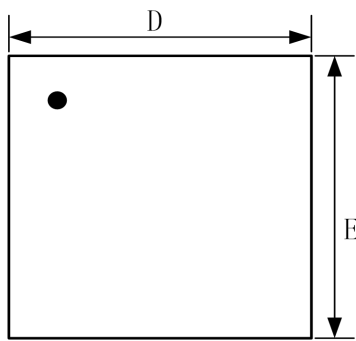

TOP VIEW

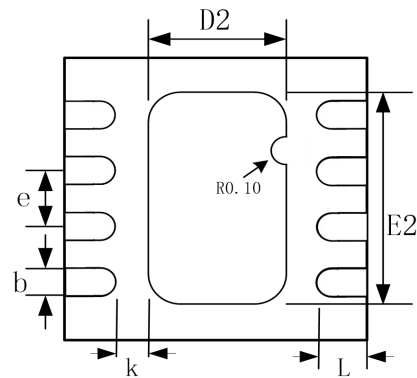

BOTTOM VIEW

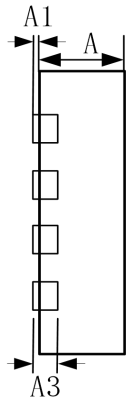

SIDE VIEW

Symbol	Dimensions In Millimeters (mm)		
	Min.	Typ.	Max.
A	0.70	0.75	0.80
A1	0.00	0.02	0.05
A3	-	0.20 REF	-
b	0.19	0.24	0.29
D	2.00 BSC		
E	2.00 BSC		
D2	0.75	0.80	0.85
E2	1.25	1.30	1.35
e	0.50 BSC		
L	0.30	0.35	0.40
k	0.20	-	-

TAPE AND REEL INFORMATION

DFN2×2-8

Reel Dimensions

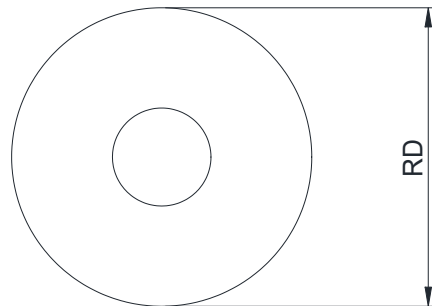

Tape Dimensions

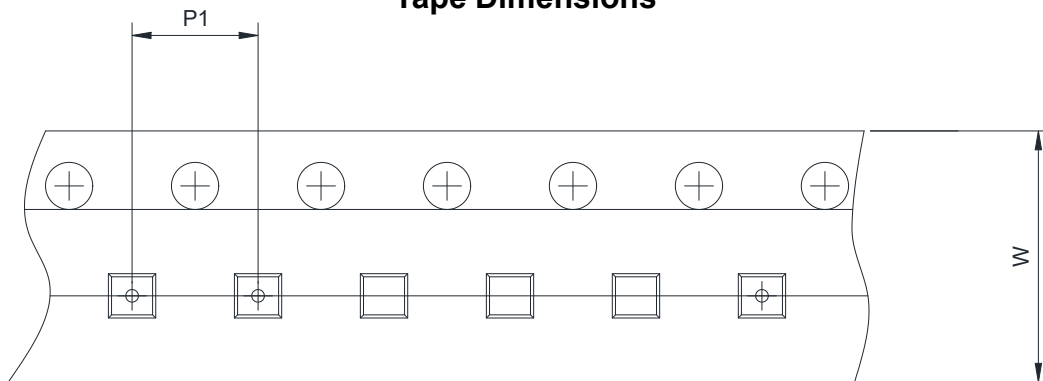

Quadrant Assignments For PIN1 Orientation In Tape

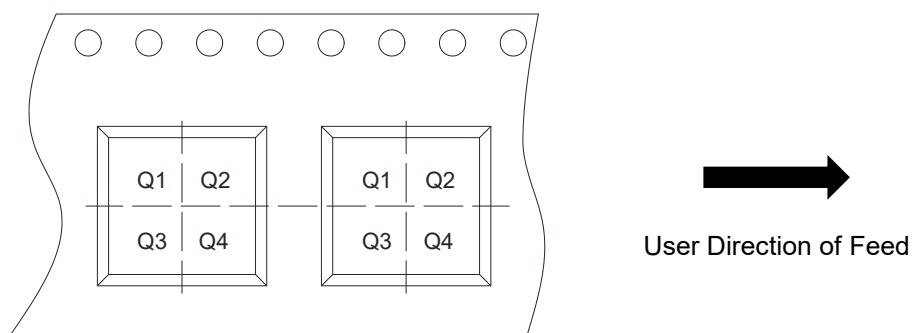

RD	Reel Dimension	<input checked="" type="checkbox"/> 7inch	<input type="checkbox"/> 13inch		
W	Overall width of the carrier tape	<input checked="" type="checkbox"/> 8mm	<input type="checkbox"/> 12mm		
P1	Pitch between successive cavity centers	<input type="checkbox"/> 2mm	<input checked="" type="checkbox"/> 4mm	<input checked="" type="checkbox"/> 8mm	
Pin1	Pin1 Quadrant	<input type="checkbox"/> Q1	<input checked="" type="checkbox"/> Q2	<input type="checkbox"/> Q3	<input type="checkbox"/> Q4

X-ON Electronics

Largest Supplier of Electrical and Electronic Components

Click to view similar products for [Operational Amplifiers - Op Amps](#) category:

Click to view products by [Will Semiconductor](#) manufacturer:

Other Similar products are found below :

[430227FB](#) [LT1678IS8](#) [NCV33202DMR2G](#) [NJM324E](#) [M38510/13101BPA](#) [NTE925](#) [AZV358MTR-G1](#) [AP4310AUMTR-AG1](#)
[AZV358MMTR-G1](#) [SCY33178DR2G](#) [NCV20034DR2G](#) [NTE778S](#) [NTE871](#) [NTE937](#) [NJU7057RB1-TE2](#) [SCY6358ADR2G](#)
[NJM2904CRB1-TE1](#) [UPC4570G2-E1-A](#) [UPC4741G2-E1-A](#) [UPC4574GR-9LG-E1-A](#) [NJM8532RB1-TE1](#) [EL2250CS](#) [EL5100IS](#) [EL5104IS](#)
[EL5127CY](#) [EL5127CYZ](#) [EL5133IW](#) [EL5152IS](#) [EL5156IS](#) [EL5162IS](#) [EL5202IY](#) [EL5203IY](#) [EL5204IY](#) [EL5210CS](#) [EL5210CYZ](#)
[EL5211IYE](#) [EL5220CY](#) [EL5223CLZ](#) [EL5223CR](#) [EL5224ILZ](#) [EL5227CLZ](#) [EL5227CRZ](#) [EL5244CS](#) [EL5246CS](#) [EL5246CSZ](#) [EL5250IY](#)
[EL5251IS](#) [EL5257IS](#) [EL5260IY](#) [EL5261IS](#)