

WS742904
1.5MHz Low-Power 28V Operational Amplifiers
[Http://www.willsemi.com](http://www.willsemi.com)
Descriptions

WS742904 consist of dual channel independent, high gain, internally frequency compensated operational amplifiers which are designed specifically to operate from a single power supply over a wide range of voltages. These devices are particularly useful in interface circuits with digital systems and can be operated from the single common 5VDC power supply.

The WS742904 is available in 8-pin SOP and MSOP packages. Standard products are Pb-Free and halogen-Free.

Features

- Single Supply Voltage : 3~28V
- Quiescent Current per Amp : 100 μ A Typical
- GBWP : 1.5MHz
- Slew Rate : 1.2V/ μ s
- Offset Voltage : 2mV Maximum
- Offset Voltage Temp. Drift : 2.7 μ V / °C
- EMIRR IN+ : >80dB@1GHz
- CMRR/PSRR/Gain : 120/130/115dB
- Output Short-Circuit Curr. : 20mA
- Input Common-Mode Voltage Range Includes Ground
- No Output Crossover Distortion
- No Phase Reversal from Overdriven Input
- Rail-to-Rail Output Swing
- -40°C to 125°C Operation Range

Applications

- Walkie-Talkie
- Battery Management Solution
- Transducer Amplifiers
- Summing Amplifier
- Multivibrators
- Oscillators
- DC Gain Blocks

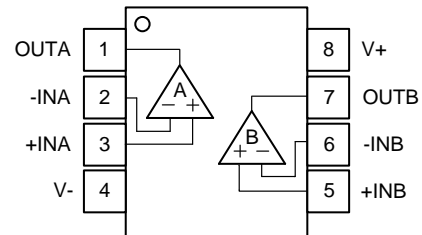
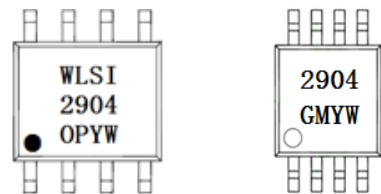
SOP-8L
MSOP-8L

SOP-8L/MSOP-8L
Pin configuration (Top view)

SOP-8L
MSOP-8L
Marking

- 2904** = Device code
- OP** = Special code
- GM** = Special code
- Y** = Year code
- W** = Week code

Order Information

Device	Package	Shipping
WS742904S-8/TR	SOP-8L	4000/Reel &Tape
WS742904M-8/TR	MSOP-8L	4000/Reel &Tape

Pin Descriptions

Pin Number	Symbol	Descriptions
1	OUTA	Output
2	-INA	Inverting input
3	+INA	Non-inverting input
4	V-	Negative supply
5	+INB	Non-inverting input
6	-INB	Inverting input
7	OUTB	Output
8	V+	Positive supply

Absolute Maximum Ratings

Parameter	Symbol	Value	Unit
Supply Voltage, ([V+] – [V-])	$V_S^{(2)}$	32	V
Input Differential Voltage	$V_{IDR}^{(3)}$	±32	V
Input Common Mode Voltage Range	V_{ICR}	V to V ⁺ -2	V
Output Short-Circuit Duration	t_{SO}	Unlimited	/
Operating Free-Air Temperature Range	T_A	-40 to 125	°C
Storage Temperature Range	T_{STG}	-65 to 150	°C
Junction Temperature Range	T_J	150	°C
Lead Temperature Range	T_L	260	°C

Note:

1. Stresses beyond those listed under Absolute Maximum Ratings may cause permanent damage to the device. These are only stress ratings, and functional operation of the device at these or any other conditions beyond those indicated under recommended operating conditions are not implied. Exposure to absolute-maximum-rated conditions for extended periods may affect device reliability.
2. All voltage values, except differential voltage are with respect to network terminal.
3. Differential voltages are at +IN with respect to –IN.

ESD, Electrostatic Discharge Protection

Symbol	Parameter	Condition	Minimum level	Unit
HBM	Human Body Model ESD	MIL-STD-883H Method 3015.8 JEDEC-EIA/JESD22-A114A	±2500	V
MM	Machine Model ESD	JEDEC-EIA/JESD22-A115	±350	V
CDM	Charged Device Model ESD	JEDEC-EIA/JESD22-C101E	±2000	V

Electronics Characteristics

The *denotes the specifications which apply over the full operating temperature range, otherwise specifications are at $T_A = 25^\circ\text{C}$. $V_S = 5\text{V}$, $V_{CM} = V_{OUT} = V_S/2$, $R_{load} = 2\text{k}\Omega$, $C_{load} = 100\text{pF}$.

Symbol	Parameter	Conditions	Min.	Typ.	Max.	Unit	
V_{OS}	Input Offset Voltage	$V_{CM} = V_S/2$	*	-2.0	± 0.1	2.0	mV
α_{VOS}	Input Offset Voltage Drift			2.7		$\mu\text{V}/^\circ\text{C}$	
I_{IB}	Input Bias Current			20		pA	
I_{OS}	Input Offset Current			20		pA	
V_n	Input Voltage Noise	$f=0.1\text{Hz to }10\text{Hz}$		6		μV_{P-P}	
e_n	Input Voltage Noise Density	$f=1\text{kHz}$		38		nV/ $\sqrt{\text{Hz}}$	
		$f=10\text{kHz}$		27			
CMRR	Common Mode Rejection Ratio	DC, $V_S=28\text{V}$, $V_{CM}=0\text{V to }26\text{V}$	*	105	120		dB
V_{CM}	Common Mode Input Voltage Range	$V_S=5\text{V to }28\text{V}$	*	V^-		V^+-2	V
PSRR	Power Supply Rejection Ratio	$V_S=5\text{V to }28\text{V}$	*	115	130		dB
A_{VOL}	Open Loop Large Signal Gain	$V_S=5\text{V}$, $V_{OUT}=0.1\text{V to }4.9\text{V}$, $R_{load}=2\text{k}\Omega$	*	90	95		dB
		$V_S=15\text{V}$, $V_{OUT}=1\text{V to }14\text{V}$, $R_{load}=10\text{k}\Omega$	*	105	120		
V_{OH}	High Level Output Voltage	$R_{load}=2\text{k}\Omega$			14.20		V
		$R_{load}=10\text{k}\Omega$			14.85		
V_{OL}	Low Level Output Voltage	$R_{load}=2\text{k}\Omega$			-14.55		V
		$R_{load}=10\text{k}\Omega$			-14.90		
I_{SC}	Output Short-Circuit Current	Source Current, $V_S=28\text{V}$	*	18	20		mA
		Sink Current, $V_S=28\text{V}$	*	18	22		
I_Q	Quiescent Current per Amplifier	$V_S=5\text{V}$, No Load	*		100	115	μA
		$V_S=28\text{V}$, No Load	*		120	145	
PM	Phase Margin	$R_{load}=2\text{k}\Omega$, $C_{load}=100\text{pF}$			67		degrees
GM	Gain Margin	$R_{load}=2\text{k}\Omega$, $C_{load}=100\text{pF}$			-15		dB
GBWP	Gain-Bandwidth Product	$f=1\text{kHz}$			1.5		MHz
t_s	Settling Time	$A_V=1$, $V_{OUT}=1\text{V}$, 0.1%			2.2		μs
SR	Slew Rate	$A_V=1$, $V_S=\pm 14\text{V}$, $V_{OUT}=-10\text{V to }10\text{V}$, $R_{load}=10\text{k}\Omega$, $C_{load}=100\text{pF}$			1.2		V/ μs
FPBW	Full Power Bandwidth				38		kHz
THD+N	Total Harmonic Distortion and Noise	$f=1\text{kHz}$, $A_V=1$, $R_{load}=2\text{k}\Omega$, $V_{OUT}=2V_{PP}$			-97		dB
X_{talk}	Channel Separation	$f=1\text{kHz}$			115		dB

Note:

1. Stresses beyond those listed under Absolute Maximum Ratings may cause permanent damage to the device. Exposure to any Absolute Maximum Rating condition for extended periods may affect device reliability and lifetime.
2. A heat sink may be required to keep the junction temperature below the absolute maximum rating when the output is shorted indefinitely.
3. Thermal resistance varies with the amount of PC board metal connected to the package. The specified values are for short traces connected to the leads.
4. Full power bandwidth is calculated from the slew rate $FPBW = SR/(\pi \cdot V_{P-P})$.

Typical Characteristics

$T_A=25^{\circ}\text{C}$, $V_S=\pm 14\text{V}$, $V_{CM}=0\text{V}$, $R_{load}=\text{Open}$, unless otherwise noted

Small-Signal Step Response, 100mV Step

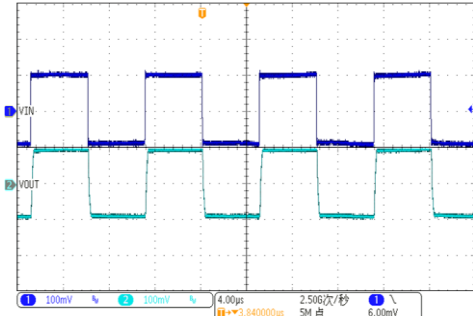

Large-Signal Step Response, 2V Step

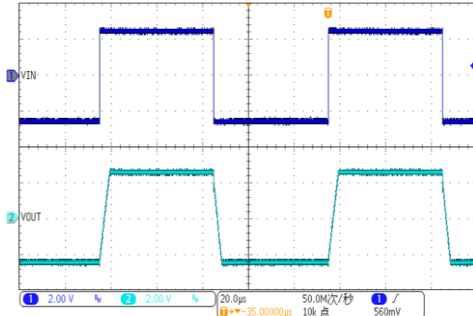

Negative/Positive Over-Voltage Recovery

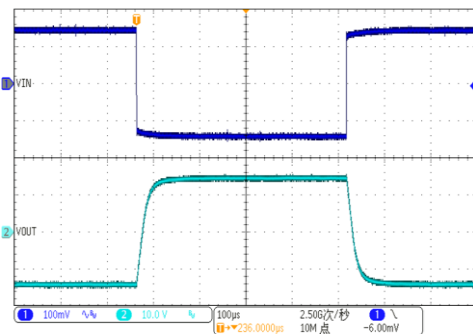

0.1Hz to 10Hz Integrated Input Noise, Gain = 50000

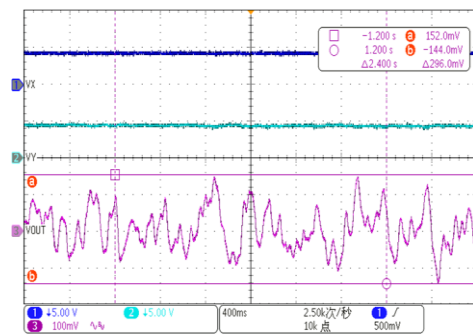

Input Offset Voltage Distribution

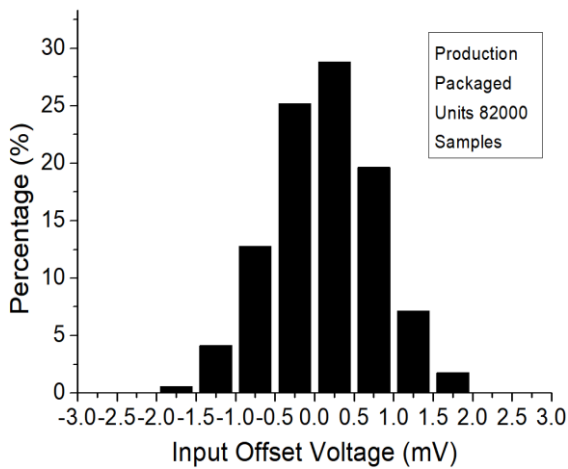

Open-Loop Gain and Phase

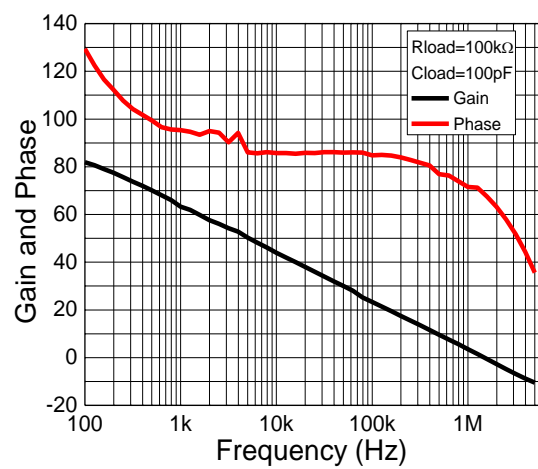

Typical Characteristics (continued)
 $T_A=25^{\circ}\text{C}$, $V_S=\pm 14\text{V}$, $V_{CM}=0\text{V}$, $R_{load}=\text{Open}$, unless otherwise noted

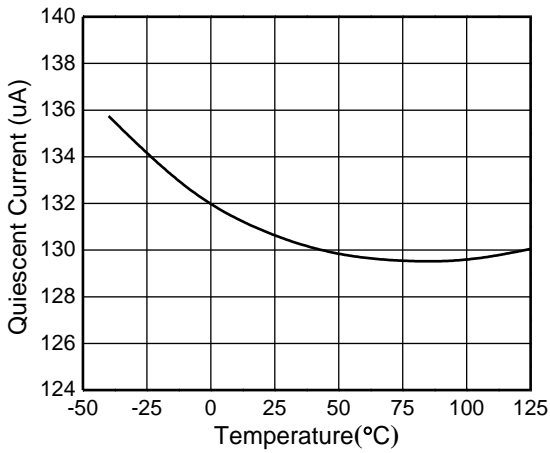
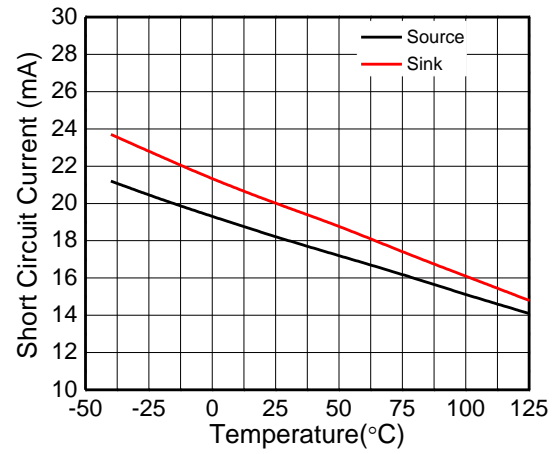
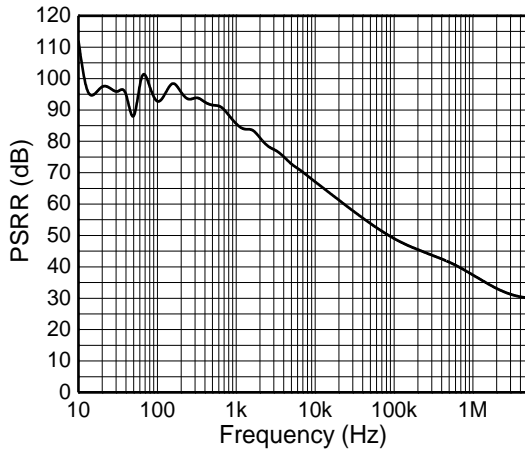
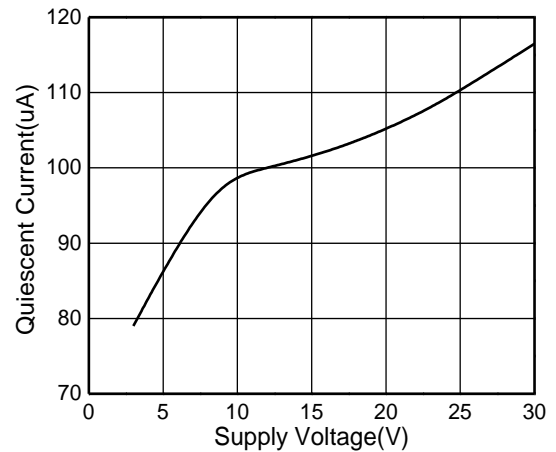
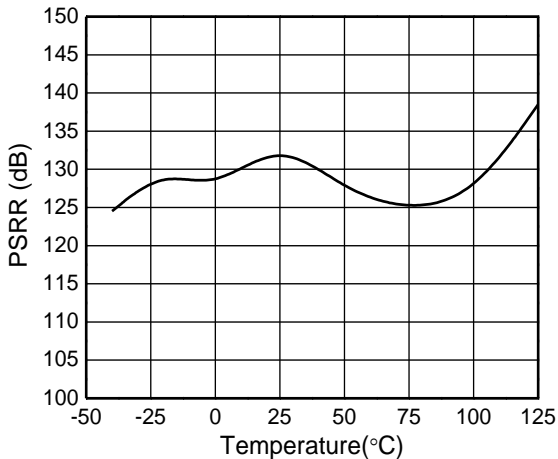
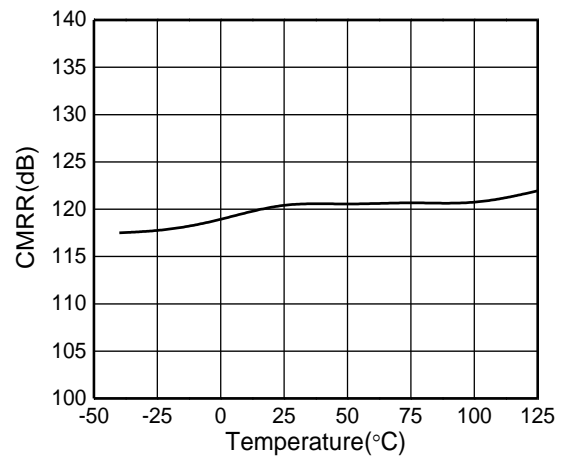
Quiescent Supply Current vs. Temperature

Short-Circuit Current vs. Temperature

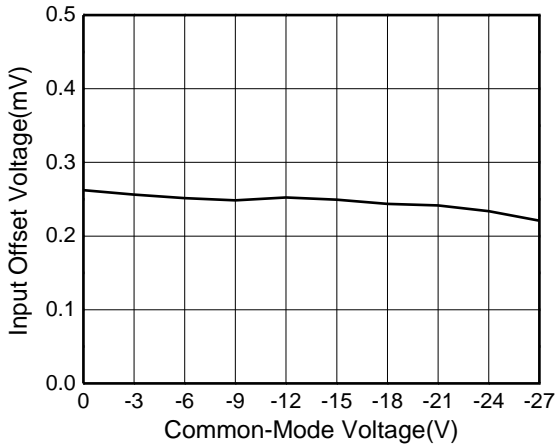
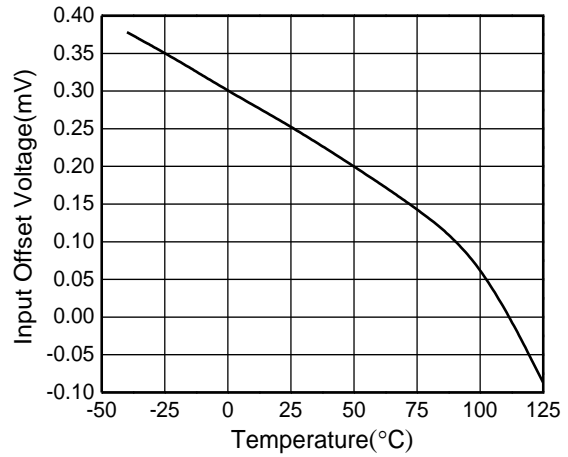
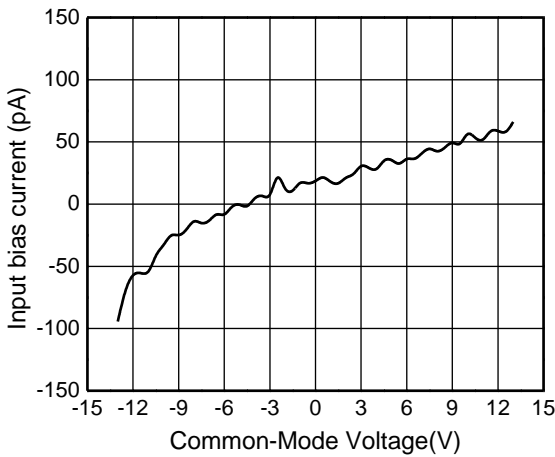
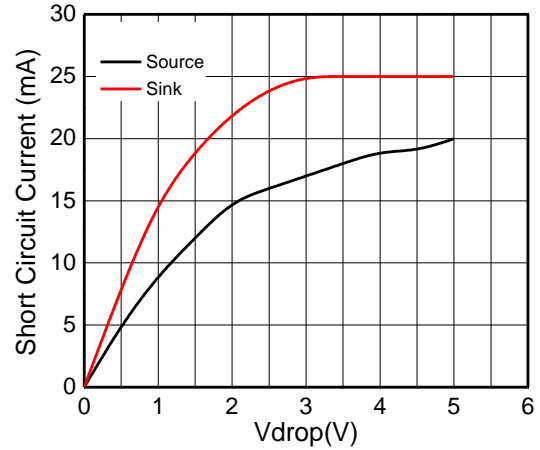
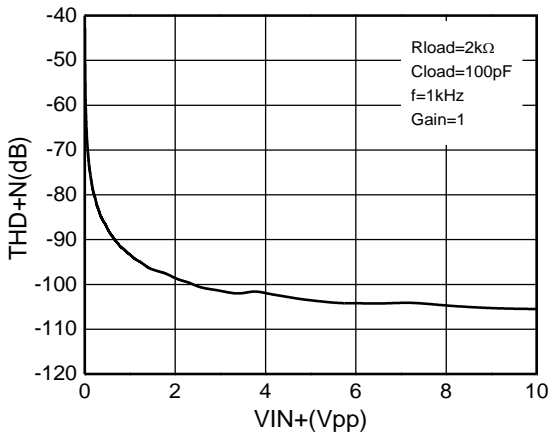
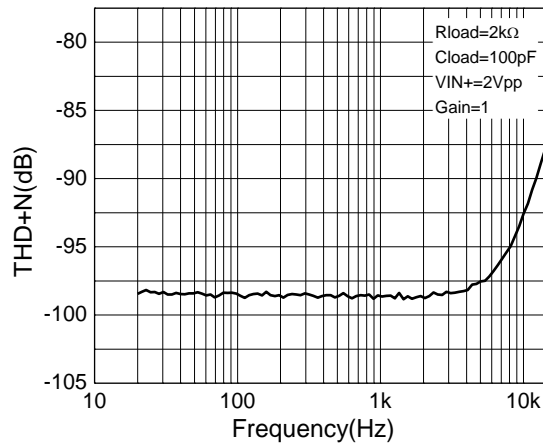
PSRR vs. Frequency

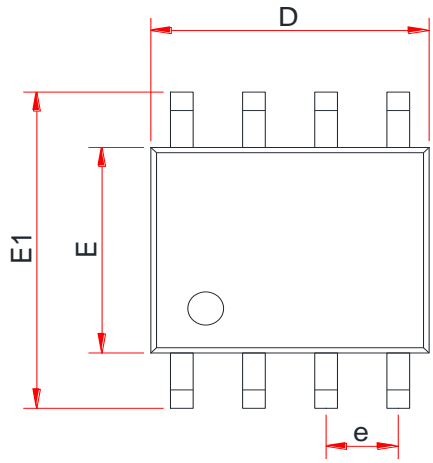
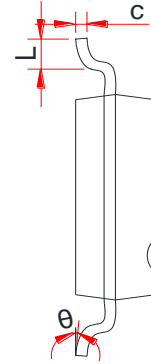
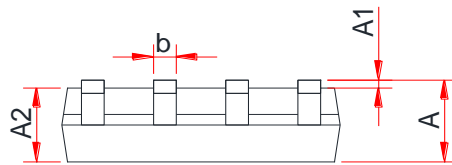
Quiescent Supply Current vs. Supply Voltage

PSRR vs. Temperature

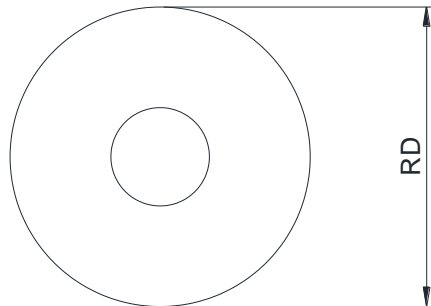
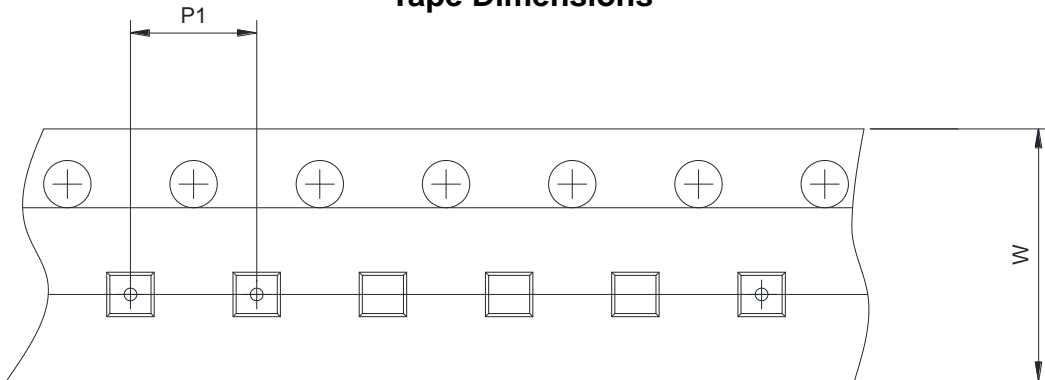
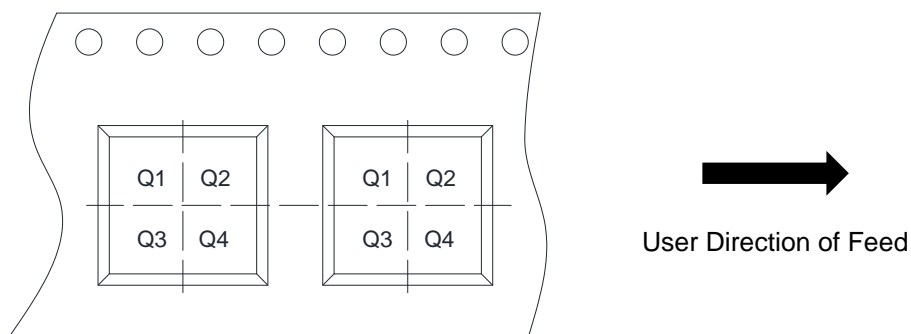
CMRR vs. Temperature

Typical Characteristics (continued)
 $T_A=25^{\circ}\text{C}$, $V_S=\pm 14\text{V}$, $V_{CM}=0\text{V}$, $R_{load}=\text{Open}$, unless otherwise noted

Input Offset Voltage vs. Common-Mode Voltage

Input Offset Voltage vs. Temperature

Input Bias Current vs. Common-Mode Voltage

Output Swing vs. Load Current

THD+Noise vs. V_{IN+}

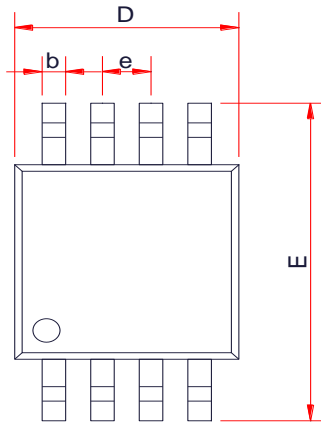
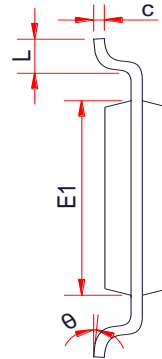
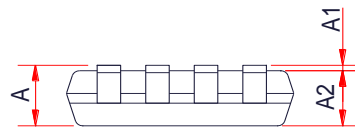
THD+Noise vs. Frequency

PACKAGE OUTLINE DIMENSIONS
SOP-8L

TOP VIEW

SIDE VIEW

SIDE VIEW

Symbol	Dimensions In Millimeters (mm)		
	Min.	Typ.	Max.
A	1.35	1.55	1.75
A1	0.05	0.15	0.25
A2	1.25	1.40	1.65
b	0.33	-	0.51
c	0.15	-	0.26
D	4.70	4.90	5.10
E	3.70	3.90	4.10
E1	5.80	6.00	6.20
e	1.27BSC		
L	0.40	-	1.27
θ	0°	-	8°

TAPE AND REEL INFORMATION
SOP-8L
Reel Dimensions

Tape Dimensions

Quadrant Assignments For PIN1 Orientation In Tape

RD	Reel Dimension	<input type="checkbox"/> 7inch	<input checked="" type="checkbox"/> 13inch		
W	Overall width of the carrier tape	<input type="checkbox"/> 8mm	<input checked="" type="checkbox"/> 12mm		
P1	Pitch between successive cavity centers	<input type="checkbox"/> 2mm	<input type="checkbox"/> 4mm	<input checked="" type="checkbox"/> 8mm	
Pin1	Pin1 Quadrant	<input checked="" type="checkbox"/> Q1	<input type="checkbox"/> Q2	<input type="checkbox"/> Q3	<input type="checkbox"/> Q4

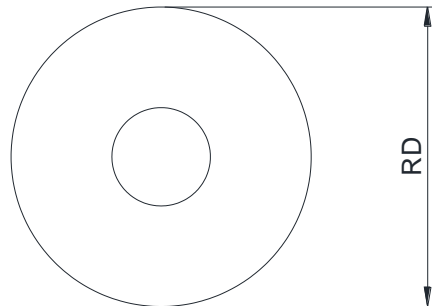
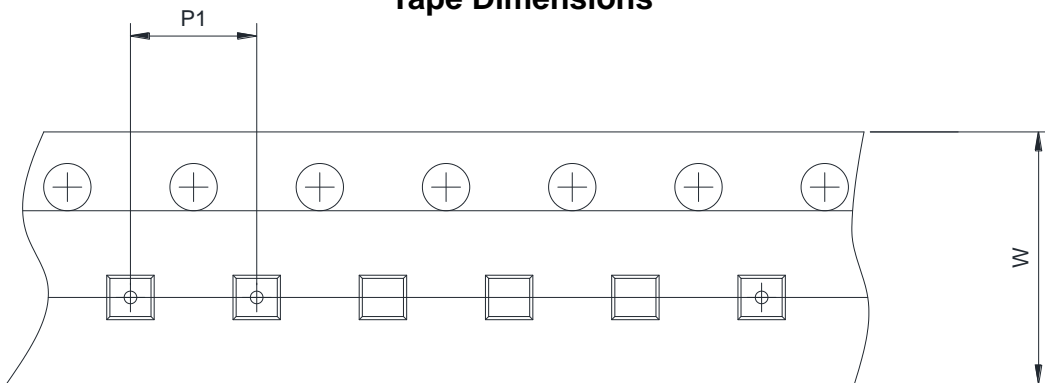
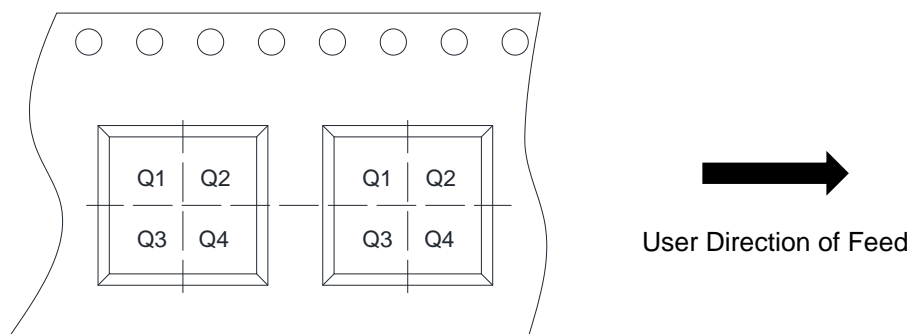
PACKAGE OUTLINE DIMENSIONS
MSOP-8L

TOP VIEW

SIDE VIEW

SIDE VIEW

Symbol	Dimensions In Millimeters (mm)		
	Min.	Typ.	Max.
A	-	-	1.10
A1	0.02	-	0.15
A2	0.75	0.80	0.95
b	0.25	-	0.38
c	0.09	-	0.23
D	2.90	3.00	3.10
E	4.75	4.90	5.05
E1	2.90	3.00	3.10
e	0.65 BSC		
L	0.40	-	0.80
θ	0°	-	6°

TAPE AND REEL INFORMATION
MSOP-8L
Reel Dimensions

Tape Dimensions

Quadrant Assignments For PIN1 Orientation In Tape

RD	Reel Dimension	<input type="checkbox"/> 7inch	<input checked="" type="checkbox"/> 13inch		
W	Overall width of the carrier tape	<input type="checkbox"/> 8mm	<input checked="" type="checkbox"/> 12mm		
P1	Pitch between successive cavity centers	<input type="checkbox"/> 2mm	<input type="checkbox"/> 4mm	<input checked="" type="checkbox"/> 8mm	
Pin1	Pin1 Quadrant	<input checked="" type="checkbox"/> Q1	<input type="checkbox"/> Q2	<input type="checkbox"/> Q3	<input type="checkbox"/> Q4

X-ON Electronics

Largest Supplier of Electrical and Electronic Components

Click to view similar products for [Operational Amplifiers - Op Amps](#) category:

Click to view products by [Will Semiconductor](#) manufacturer:

Other Similar products are found below :

[OPA2991IDSGR](#) [OPA607IDCKT](#) [007614D](#) [633773R](#) [635798C](#) [635801A](#) [702115D](#) [709228FB](#) [741528D](#) [NCV33072ADR2G](#)
[SC2902DTBR2G](#) [SC2903DR2G](#) [SC2903VDR2G](#) [LM258AYDT](#) [LM358SNG](#) [430227FB](#) [430228DB](#) [460932C](#) [AZV831KTR-G1](#) [409256CB](#)
[430232AB](#) [LM2904DR2GH](#) [LM358YDT](#) [LT1678IS8](#) [042225DB](#) [058184EB](#) [070530X](#) [SC224DR2G](#) [SC239DR2G](#) [SC2902DG](#)
[SCYA5230DR2G](#) [714228XB](#) [714846BB](#) [873836HB](#) [MIC918YC5-TR](#) [TS912BIYDT](#) [NCS2004MUTAG](#) [NCV33202DMR2G](#)
[M38510/13101BPA](#) [NTE925](#) [SC2904DR2G](#) [SC358DR2G](#) [LM358EDR2G](#) [AZV358MTR-G1](#) [AP4310AUMTR-AG1](#) [HA1630D02MMEL-E](#)
[NJM358CG-TE2](#) [HA1630S01LPEL-E](#) [LM324AWPT](#) [HA1630Q06TELL-E](#)