

WS742906

3.5MHz Low-Power 36V Operational Amplifiers

[Http://www.omnivision-group.com](http://www.omnivision-group.com)

Descriptions

WS742906 consist of dual channel independent, high gain, internally frequency compensated operational amplifiers which are designed specifically to operate from a single power supply over a wide range of voltages. These devices are particularly useful in interface circuits with digital systems and can be operated from the single common 5VDC power supply.

The WS742906 is available with MSL 3 Level in SOP-14L and TSSOP-14L package. Standard products are Pb-Free and halogen-Free.

Features

- Single Supply Voltage : 3~36V
- Quiescent Current per Amp : 120 μ A Typical
- GBWP : 3.5MHz
- Slew Rate : 2V/ μ s
- Offset Voltage : 4mV Maximum
- Offset Voltage Temp. Drift : 3 μ V/ $^{\circ}$ C
- THD+N : -100dB
- CMRR/PSRR/Gain : 130/120/125dB
- Output Short-Circuit Curr. : 21mA
- Input Common-Mode Voltage Range Includes Ground
- No Output Crossover Distortion
- No Phase Reversal from Overdriven Input
- Rail-to-Rail Output Swing
- -40 $^{\circ}$ C to 125 $^{\circ}$ C Operation Range

Applications

- Walkie-Talkie
- Battery Management Solution
- Transducer Amplifiers
- Summing Amplifier
- Multivibrators
- Oscillators
- DC Gain Blocks

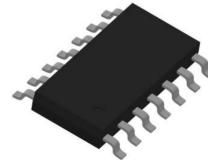

SOP-14L

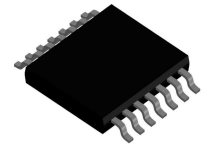

TSSOP-14L

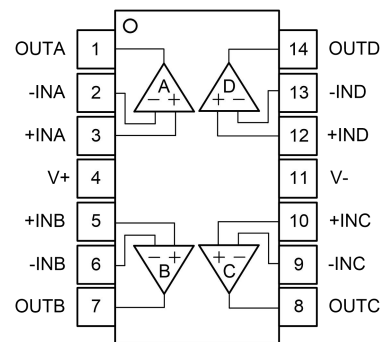

SOP-14L/TSSOP-14L

Pin configuration (Top view)

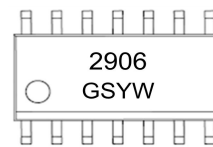

SOP-14L

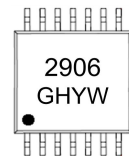

TSSOP-14L

Marking

- 2906 = Device code
 GS, GH = Special code
 Y = Year code
 W = Week code

Order information

Device	Package	Shipping
WS742906S-14/TR	SOP-14L	4000/Reel & Tape
WS742906H-14/TR	TSSOP-14L	4000/Reel & Tape

Pin Descriptions

Pin Number	Symbol	Descriptions
1	OUTA	Output of Amplifier A
2	-INA	Inverting input of Amplifier A
3	+INA	Non-inverting input of Amplifier A
4	V+	Positive supply
5	+INB	Non-inverting input of Amplifier B
6	-INB	Inverting input of Amplifier B
7	OUTB	Output of Amplifier B
8	OUTC	Output of Amplifier C
9	-INC	Inverting input of Amplifier C
10	+INC	Non-inverting input of Amplifier C
11	V-	Negative supply
12	+IND	Non-inverting input of Amplifier D
13	-IND	Inverting input of Amplifier D
14	OUTD	Output of Amplifier D

Absolute Maximum Ratings

Parameter	Symbol	Value	Unit
Supply Voltage	$V_{CC}^{(2)}$	36	V
Input Differential Voltage	$V_{IDR}^{(3)}$	± 36	V
Input Common Mode Voltage Range	V_{ICR}	V^- to $V^+ - 2$	V
Output Short-Circuit Duration	t_{SO}	Unlimited	/
Operating Free-Air Temperature Range	T_A	-40 to 125	$^{\circ}C$
Storage Temperature Range	T_{STG}	-65 to 150	$^{\circ}C$
Junction Temperature Range	T_J	150	$^{\circ}C$
Lead Temperature Range	T_L	260	$^{\circ}C$

Note:

- Stresses beyond those listed under Absolute Maximum Ratings may cause permanent damage to the device. These are only stress ratings, and functional operation of the device at these or any other conditions beyond those indicated under recommended operating conditions are not implied. Exposure to absolute-maximum-rated conditions for extended periods may affect device reliability.
- All voltage values, except differential voltage are with respect to network terminal.
- Differential voltages are at IN+ with respect to IN-.

ESD, Electrostatic Discharge Protection

Symbol	Parameter	Condition	Minimum level	Unit
HBM	Human Body Model ESD	MIL-STD-883H Method 3015.8 JEDEC-EIA/JESD22-A114A	± 1500	V
CDM	Charged Device Model ESD	JEDEC-EIA/JESD22-C101E	± 1500	V

Electronics Characteristics

The * denotes the specifications which apply over the full operating temperature range, otherwise specifications are at $T_A = 25^\circ\text{C}$. $V_S = 30\text{V}$, $V_{\text{CM}} = V_{\text{OUT}} = V_S/2$, $R_{\text{load}} = 2\text{k}\Omega$, $C_{\text{load}} = 100\text{pF}$.

Symbol	Parameter	Conditions	Min.	Typ.	Max.	Unit	
V_{OS}	Input Offset Voltage	$V_{\text{CM}} = V_{\text{SUPPLY}}/2$	*	-4.0	± 0.1	4.0 mV	
α_{VOS}	Input Offset Voltage Drift			3		$\mu\text{V}/^\circ\text{C}$	
I_{IB}	Input Bias Current			20		pA	
I_{OS}	Input Offset Current			20		pA	
V_{n}	Input Voltage Noise	$f=0.1\text{Hz to }10\text{Hz}$		8		$\mu\text{V}_{\text{P-P}}$	
e_{n}	Input Voltage Noise Density	$f=1\text{KHz}$		32		$\text{nV}/\sqrt{\text{Hz}}$	
		$f=10\text{KHz}$		23		Hz	
CMRR	Common Mode Rejection Ratio	DC, $V_S=30\text{V}$, $V_{\text{CM}}=0\text{V}$ to 28V	*	100	130	dB	
V_{CM}	Common Mode Input Voltage Range	$V_S=5\text{V to }30\text{V}$	*	V^-	V^+-2	V	
PSRR	Power Supply Rejection Ratio	$V_S=5\text{V to }30\text{V}$	*	100	120	dB	
A_{VOL}	Open Loop Large Signal Gain	$V_S=5\text{V}$, $V_{\text{OUT}}=0.1\text{V to }4.9\text{V}$, $R_{\text{LOAD}}=2\text{k}\Omega$			95	dB	
		$V_S=15\text{V}$, $V_{\text{OUT}}=1\text{V to }14\text{V}$, $R_{\text{LOAD}}=10\text{k}\Omega$	*	100	125		
V_{OH}	High Level Output Voltage	$R_{\text{LOAD}}=2\text{k}\Omega$			13.6	V	
		$R_{\text{LOAD}}=10\text{k}\Omega$	*	14.70	14.73		
V_{OL}	Low Level Output Voltage	$R_{\text{LOAD}}=2\text{k}\Omega$			-13.9	V	
		$R_{\text{LOAD}}=10\text{k}\Omega$	*		-14.81		-14.77
I_{SC}	Output Short-Circuit Current	Source Current, $V_S=30\text{V}$			21	mA	
		Sink Current, $V_S=30\text{V}$			23		
I_{Q}	Quiescent Current per Amplifier	$V_S=5\text{V}$ No Load	*		120	168	μA
		$V_S=30\text{V}$ No Load	*		140	183	
PM	Phase Margin	$R_{\text{LOAD}}=2\text{k}\Omega$, $C_{\text{LOAD}}=100\text{pF}$			67	$^\circ$	
GM	Gain Margin	$R_{\text{LOAD}}=2\text{k}\Omega$, $C_{\text{LOAD}}=100\text{pF}$			-15	dB	
GBWP	Gain-Bandwidth Product	$f=1\text{kHz}$			3.5	MHz	
t_{s}	Settling Time	$A_{\text{V}}=1$, $V_{\text{OUT}}=1\text{V}$, 0.1%			1.4	μs	
SR	Slew Rate	$A_{\text{V}}=1$, $V_S=\pm 15\text{V}$, $V_{\text{OUT}}=-10\text{V to }10\text{V}$, $R_{\text{LOAD}}=10\text{k}\Omega$, $C_{\text{LOAD}}=100\text{pF}$			2	$\text{V}/\mu\text{s}$	
FPBW	Full Power Bandwidth				58	kHz	
THD+N	Total Harmonic Distortion and Noise	$f=1\text{kHz}$, $A_{\text{V}}=1$, $R_{\text{LOAD}}=2\text{k}\Omega$, $V_{\text{OUT}}=2V_{\text{PP}}$			-100	dB	
X_{talk}	Channel Separation	$f=1\text{kHz}$			95	dB	

Note:

1. Stresses beyond those listed under Absolute Maximum Ratings may cause permanent damage to the device. Exposure to any Absolute Maximum Rating condition for extended periods may affect device reliability and lifetime.
2. A heat sink may be required to keep the junction temperature below the absolute maximum rating when the output is shorted indefinitely.
3. Thermal resistance varies with the amount of PC board metal connected to the package. The specified values are for short traces connected to the leads.
4. Full power bandwidth is calculated from the slew rate $FPBW = SR/(\pi \cdot V_{P-P})$.

Typical Characteristics

$T_A=25^{\circ}\text{C}$, $V_S=\pm 15\text{V}$, $V_{CM}=0\text{V}$, $R_{load}=\text{Open}$, unless otherwise noted

Small-Signal Step Response, 100mV Step

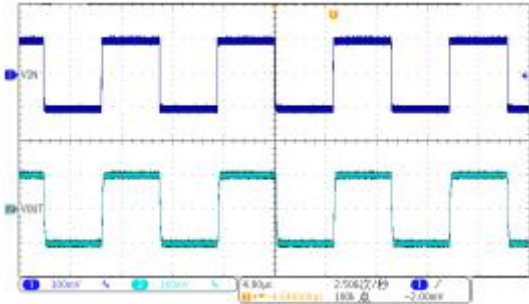

Large-Signal Step Response, 2V Step

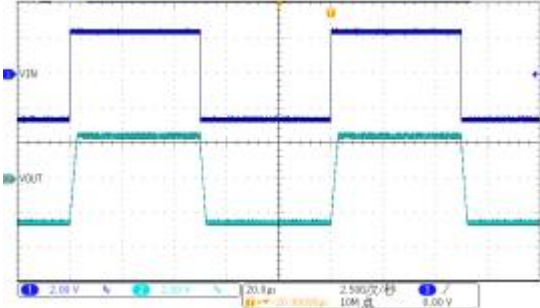

Negative/Positive Over-Voltage Recovery

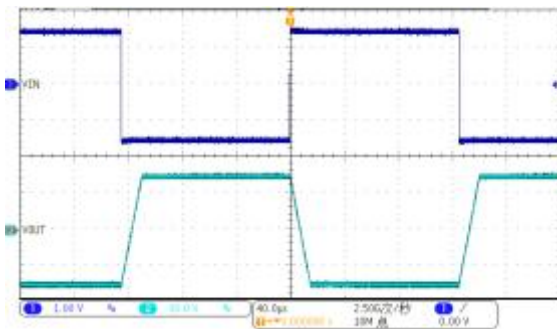

0.1Hz to 10Hz Integrated Input Noise,
Gain = 50000

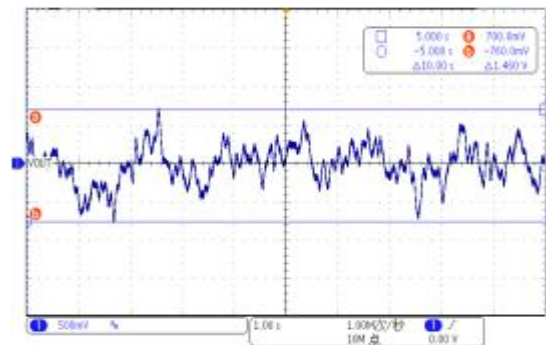

Input Offset Voltage Distribution

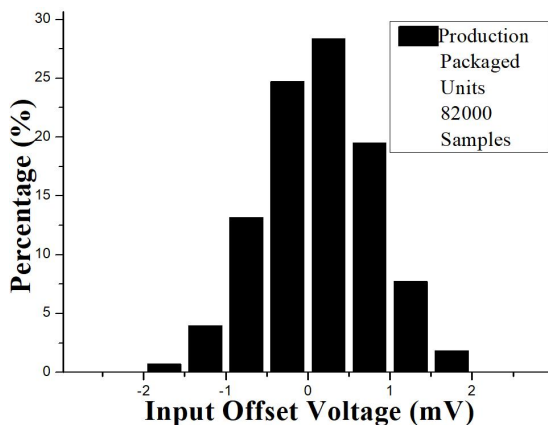

Open-Loop Gain and Phase

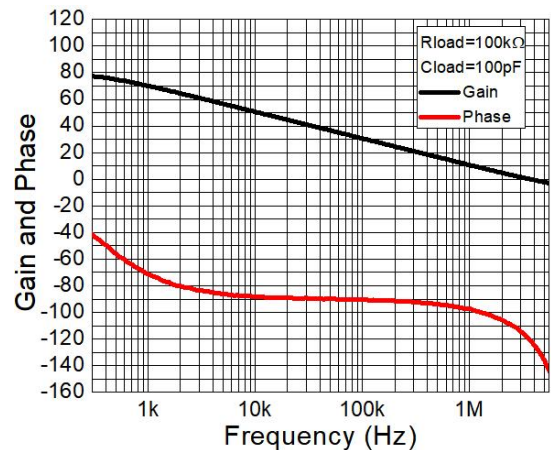

Typical Characteristics (continued)

$T_A=25^{\circ}\text{C}$, $V_S=\pm 15\text{V}$, $V_{\text{CM}}=0\text{V}$, $R_{\text{load}}=\text{Open}$, unless otherwise noted

Quiescent Supply Current vs. Temperature

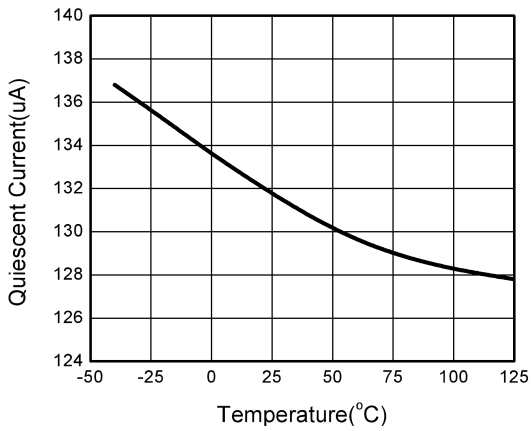

Short-Circuit Current vs. Temperature

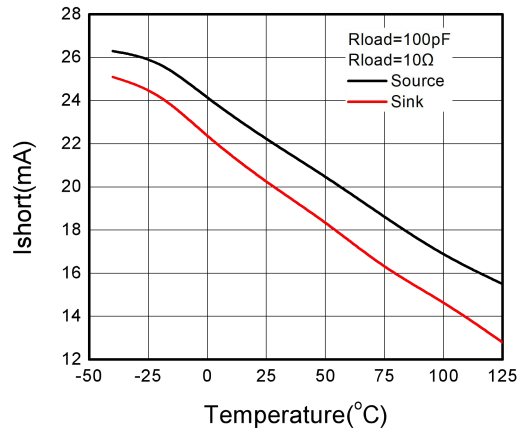

PSRR vs. Frequency

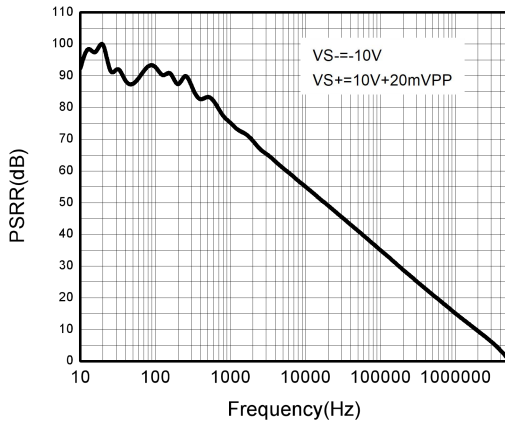

Quiescent Supply Current vs. Supply Voltage

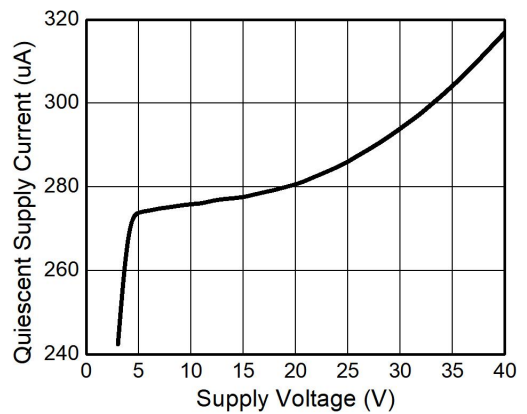

PSRR vs. Temperature

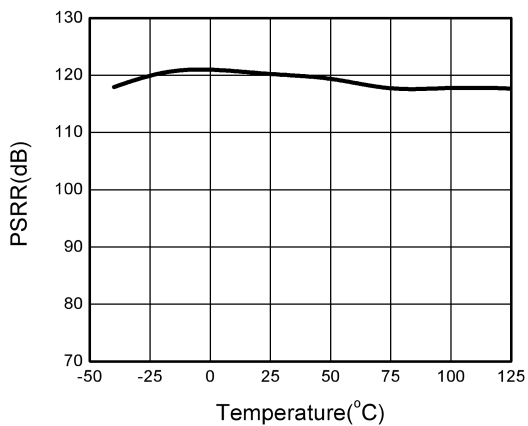

CMRR vs. Temperature

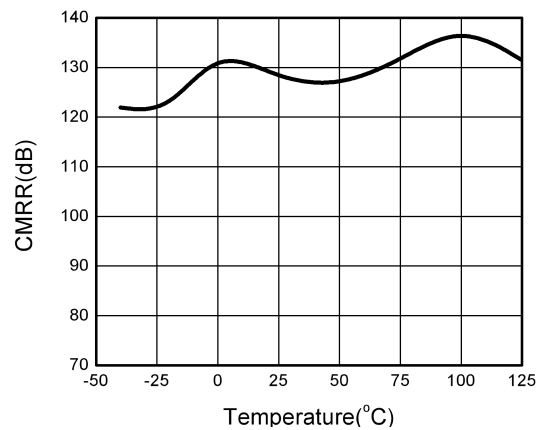

Typical Characteristics (continued)

$T_A=25^{\circ}\text{C}$, $V_S=\pm 15\text{V}$, $V_{\text{CM}}=0\text{V}$, $R_{\text{load}}=\text{Open}$, unless otherwise noted

Input Offset Voltage vs. Common-Mode Voltage

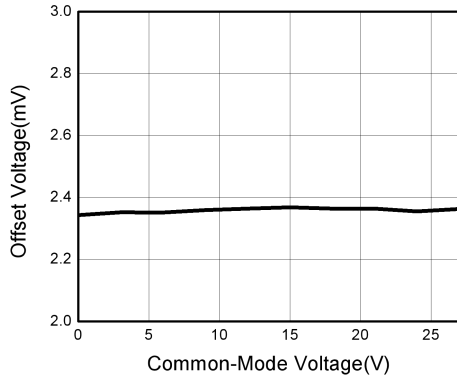

Input Offset Voltage vs. Temperature

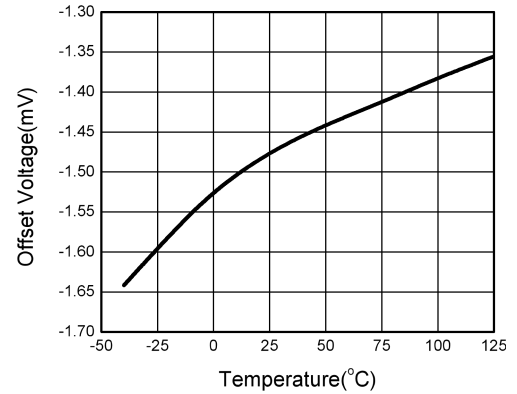

Input Bias Current vs. Common-Mode Voltage

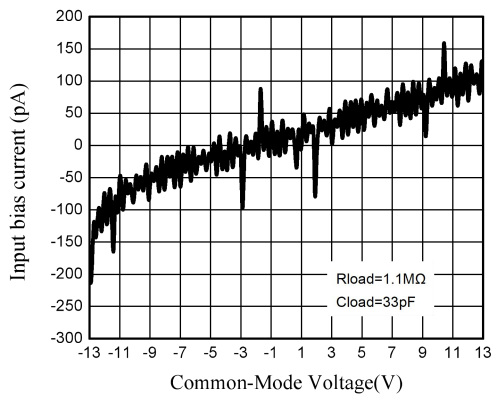

Crosstalk, $V_{\text{in}+}=1\text{k}\Omega$ to GND

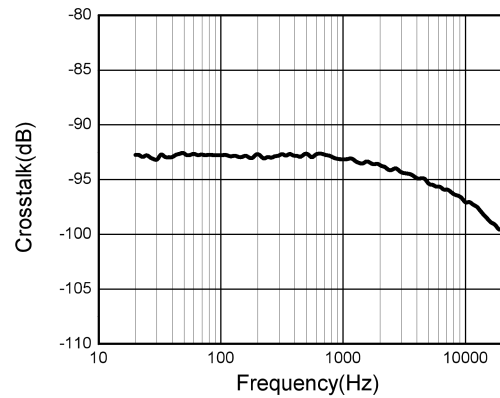

THD+Noise vs. $V_{\text{in}+}$

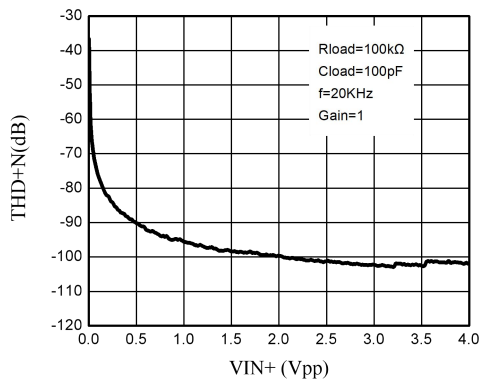

THD+Noise vs. Frequency

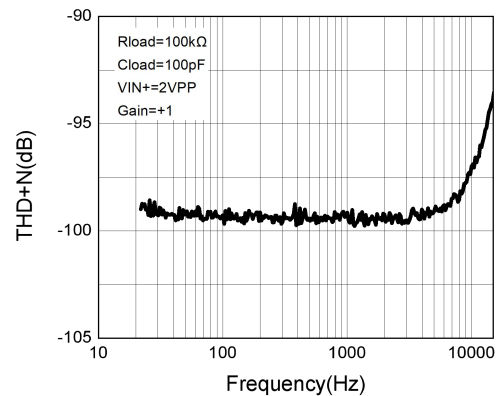

PACKAGE OUTLINE DIMENSIONS

SOP-14L

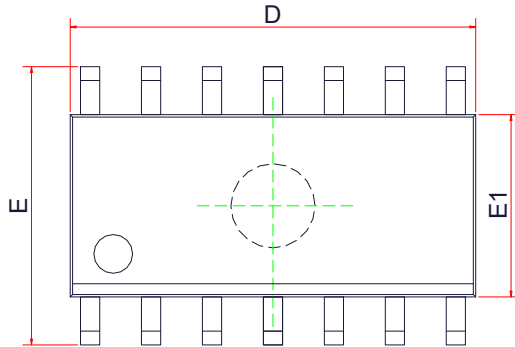

TOP VIEW

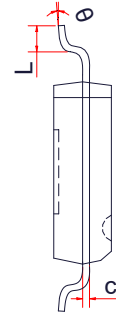

SIDE VIEW

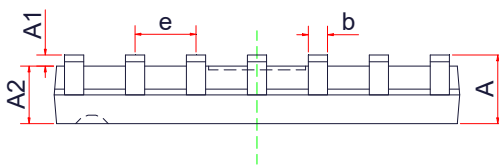

SIDE VIEW

Symbol	Dimensions In Millimeters (mm)		
	Min.	Typ.	Max.
A	-	-	1.75
A1	0.10	-	0.25
A2	1.25	-	-
b	0.31	0.41	0.51
c	0.10	-	0.25
D	8.45	8.65	8.85
E	5.80	6.00	6.20
E1	3.80	3.90	4.00
e	1.27 BSC		
L	0.40	-	1.27
θ	0°	-	8°

TAPE AND REEL INFORMATION

SOP-14L

Reel Dimensions

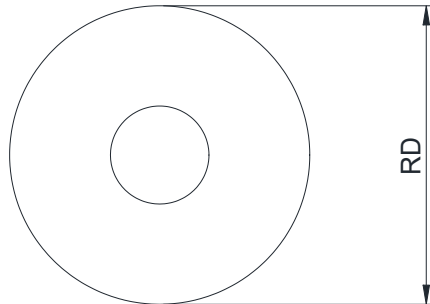

Tape Dimensions

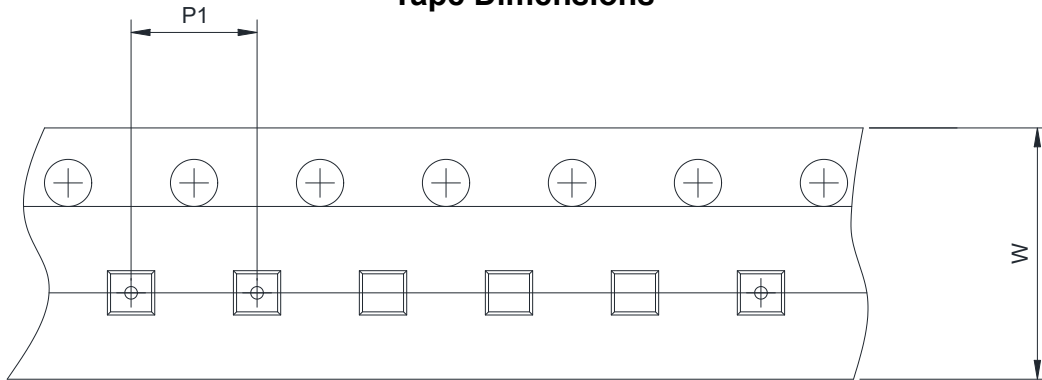

Quadrant Assignments For PIN1 Orientation In Tape

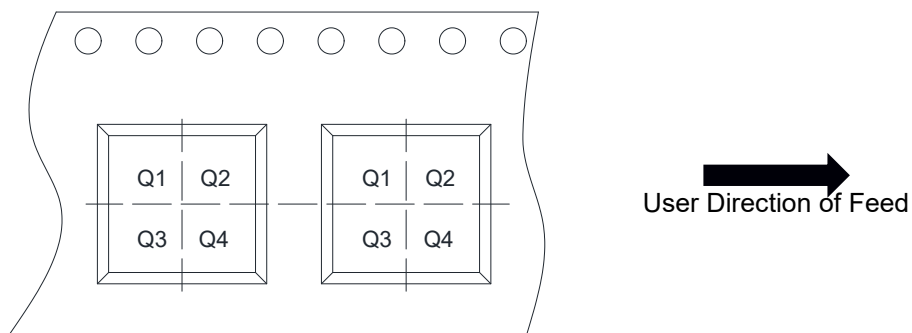

RD	Reel Dimension	<input type="checkbox"/> 7inch	<input checked="" type="checkbox"/> 13inch
W	Overall width of the carrier tape	<input type="checkbox"/> 8mm	<input type="checkbox"/> 12mm <input checked="" type="checkbox"/> 16mm
P1	Pitch between successive cavity centers	<input type="checkbox"/> 2mm	<input type="checkbox"/> 4mm <input checked="" type="checkbox"/> 8mm
Pin1	Pin1 Quadrant	<input checked="" type="checkbox"/> Q1	<input type="checkbox"/> Q2 <input type="checkbox"/> Q3 <input type="checkbox"/> Q4

PACKAGE OUTLINE DIMENSIONS

TSSOP-14L

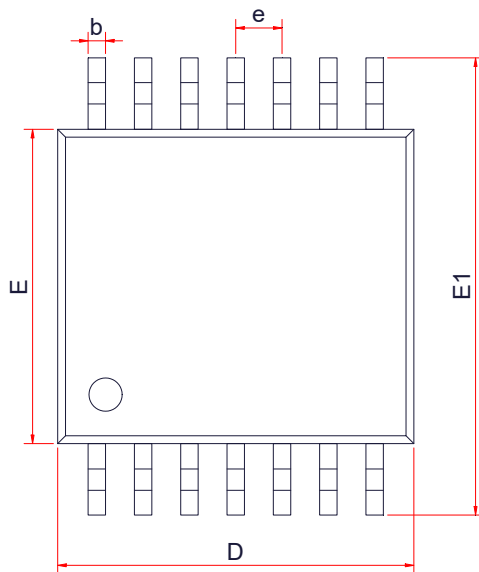

TOP VIEW

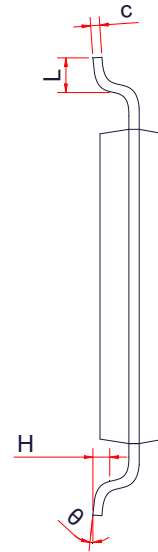

SIDE VIEW



SIDE VIEW

Symbol	Dimensions in Millimeters		
	Min.	Typ.	Max.
A	-	-	1.20
A1	0.05	-	0.15
A2	0.80	0.90	1.00
b	0.19	-	0.30
c	0.09	-	0.20
D	4.90	5.00	5.10
E	4.30	4.40	4.50
E1	6.25	6.40	6.55
e	0.65 BSC		
L	0.50	0.60	0.70
H	0.25Typ		
θ	1 °	-	7 °

TAPE AND REEL INFORMATION

TSSOP-14L

Reel Dimensions

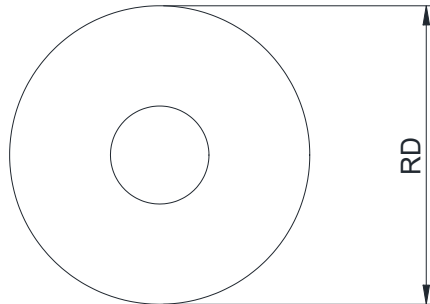

Tape Dimensions

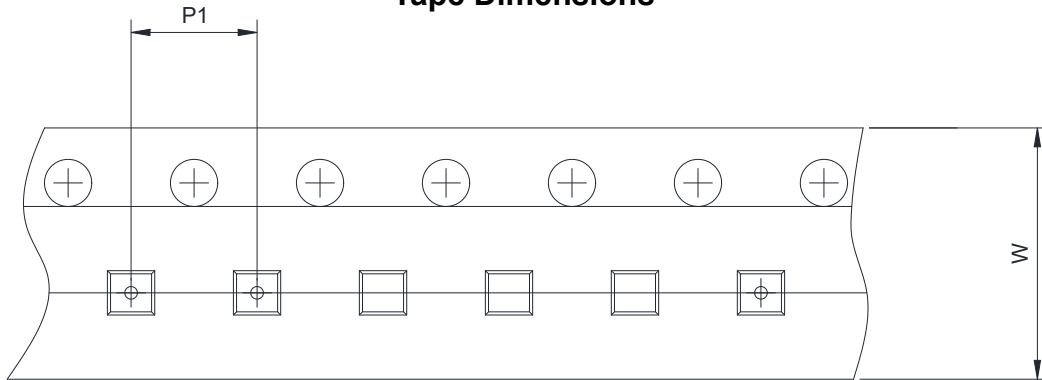

Quadrant Assignments For PIN1 Orientation In Tape

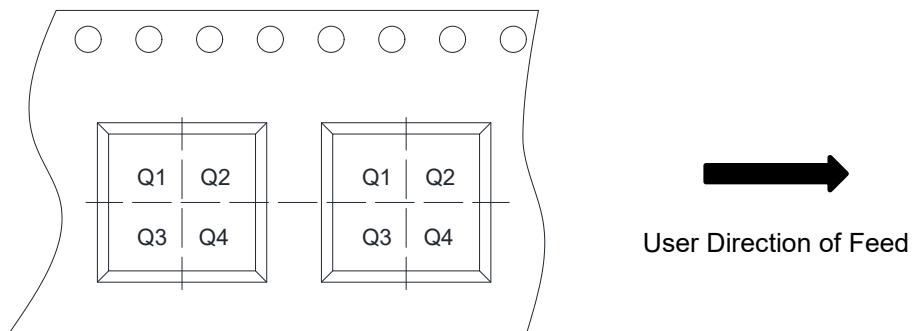

RD	Reel Dimension	<input type="checkbox"/> 7inch	<input checked="" type="checkbox"/> 13inch
W	Overall width of the carrier tape	<input type="checkbox"/> 8mm	<input checked="" type="checkbox"/> 12mm <input type="checkbox"/> 16mm
P1	Pitch between successive cavity centers	<input type="checkbox"/> 2mm	<input type="checkbox"/> 4mm <input checked="" type="checkbox"/> 8mm
Pin1	Pin1 Quadrant	<input checked="" type="checkbox"/> Q1	<input type="checkbox"/> Q2 <input type="checkbox"/> Q3 <input type="checkbox"/> Q4

X-ON Electronics

Largest Supplier of Electrical and Electronic Components

Click to view similar products for [Operational Amplifiers - Op Amps](#) category:

Click to view products by [Will Semiconductor](#) manufacturer:

Other Similar products are found below :

[430227FB](#) [LT1678IS8](#) [NCV33202DMR2G](#) [NJM324E](#) [M38510/13101BPA](#) [NTE925](#) [AZV358MTR-G1](#) [AP4310AUMTR-AG1](#)
[AZV358MMTR-G1](#) [SCY33178DR2G](#) [NCV20034DR2G](#) [NTE778S](#) [NTE871](#) [NTE937](#) [NJU7057RB1-TE2](#) [SCY6358ADR2G](#)
[NJM2904CRB1-TE1](#) [UPC4570G2-E1-A](#) [UPC4741G2-E1-A](#) [NJM8532RB1-TE1](#) [EL2250CS](#) [EL5100IS](#) [EL5104IS](#) [EL5127CY](#) [EL5127CZY](#)
[EL5133IW](#) [EL5152IS](#) [EL5156IS](#) [EL5162IS](#) [EL5202IY](#) [EL5203IY](#) [EL5204IY](#) [EL5210CS](#) [EL5210CZY](#) [EL5211IYE](#) [EL5220CY](#)
[EL5223CLZ](#) [EL5223CR](#) [EL5224ILZ](#) [EL5227CLZ](#) [EL5227CRZ](#) [EL5244CS](#) [EL5246CS](#) [EL5246CSZ](#) [EL5250IY](#) [EL5251IS](#) [EL5257IS](#)
[EL5260IY](#) [EL5261IS](#) [EL5300IU](#)