

Ethernet PSE power supply module

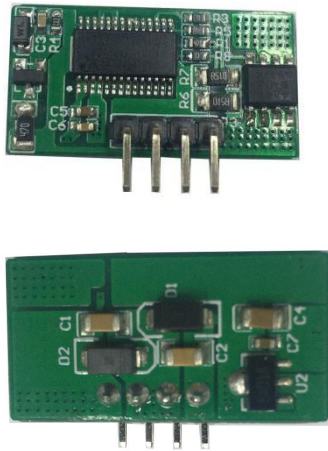

1.Product features

- Compliant with IEEE802.3at Type
- 42V ~ 57V wide DC voltage input range.
- The output power is up to 30W under IEEE 802.3at standard.
- Output over current short circuit protection.
- PCBA standard size: 27mm*14mm*5mm
- High reliability: The design meets the 5 million hour average failure interval.

2.Scope of application

- Ethernet switches and routers
- Monitor NVR and DVR
- Residential gateway
- Poe through system
- wireless backhaul

3.Description

- WC-PSE48-48 is a single port IEEE802.3at power supply equipment (PSE) for flexible use through Ethernet (PoE) applications.
- The power supply device (PD) with valid signature is automatically detected, and the power supply demand is determined according to the classification, and the power supply is applied. Supports two event classification for type 2 PD.
- The WC-PSE48-48 is an independent module that requires only a few external components to provide a large amount of control and feedback for each power supply unit (PD) connected to the PSE.

4. Mechanical dimensions

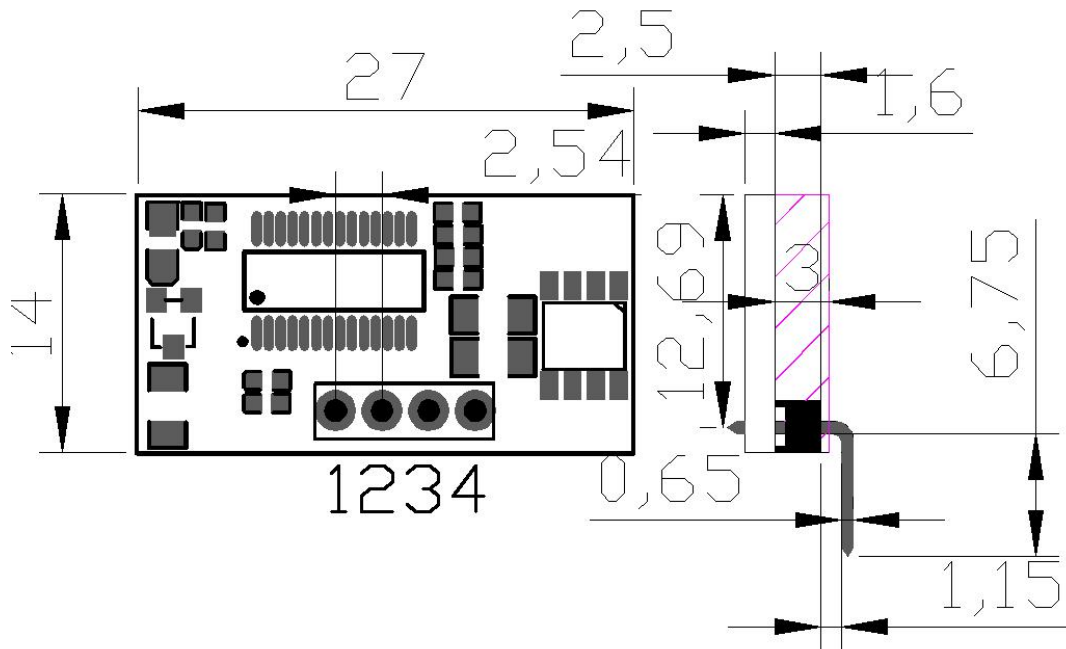

Company (mm)

All the above dimensional errors: (± 0.3)

5. pin definition

Pin	Name	describe
1	Vin-	is the input negative pole of 42~57V DC power supply.
2	Vin+	is 42~57V DC power input positive pole.
3	PSE+	This pin is the positive pole of PSE output.
4	PSE-	This pin is the negative pole of PSE output.

*The input terminal is not preset with a protection diode, so pay attention to the positive and negative polarity!

5. Electrical characteristics

5.1 Absolute maximum rating parameter

No	parameter	Symbol	MIN	MAX	Units
1	DC Voltage	VCC	42	57	V
2	DC Voltage Surge 1ms	VSURGE	-0.6	20	V
3	ambient temperature	TS	-40	120	°C

*Exceeding the above rating may cause permanent damage to the product. Functional operations under these conditions are not recommended.

5.2 Recommended working conditions

No	parameter	Symbol	MIN	TYP	MAX	Units
1	input voltage	VIN	42	48	57	V
2	Low Voltage Lock	VLOCK	41	-	-	V
3	working temperature	TOP	-40	25	80	°C

*Applicable only to WC-PSE48-48 maximum operating temperature.

5.3 Characteristic

No	PARAMETER	TEST CONDITIONS	MIN	TYP	MAX	UNIT
DETECTION						
1	I _{DET} Detection curren	First detection point, V _{VPWR} - V _{DRAINn} = 0 V	145	160	190	μA
2		2nd detection point, V _{VPWR} - V _{DRAINn} = 0 V	235	270	300	μA
3		High Current detection point, V _{VPWR} - V _{DRAINn} = 0 V	490	540	585	μA
4	Δ I _{DET} currents 2nd - 1st detection	At V _{VPWR} - V _{DRAINn} = 0 V	98	110	118	μA
5	V _{detect} Open circuit detection voltage	V _{VPWR} - V _{DRAINn}	17.5	19	22	V
6	R _{REJ-LOW} Rejected resistance low range		0.85		15	K Ω
7	R _{REJ-HI} Rejected resistance high range		33		50	K Ω
8	R _{ACCEPT} Accepted resistance range		19	25	26.5	K Ω
9	R _{SHORT} Shorted port threshold				350	K Ω
10	R _{OPEN} Open port threshold		55			K Ω

(1) The technical parameters are for reference only and do not constitute part of the guarantee of the company's product specifications

(2) Output ripple and noise can be reduced by an external filter, see the application instructions.

5.4 Characteristic (continued)

No	PARAMETER	TEST CONDITIONS	MIN	TYP	MAX	UNIT
CLASSIFICATION						
1	V _{CLASS} Classification voltage	$V_{VPWR} - V_{DRAINn}, V_{SENn} \geq 0$ mV, $I_{port} \geq 180 \mu A,$	15.5	18.5	20.5	V
2	C _{CLASS-Lim} Classification current limit	$V_{VPWR} - V_{DRAINn} = 0 V$	-	70	90	mA
3	I _{CLASS_TH} Classification threshold current	Class 0-1	5	-	8	mA
4		Class 1-2	13	-	16	mA
5		Class 2-3	21	-	25	mA
6		Class 3-4	31	-	35	mA
7		Class 4-overcurrent	45	-	51	mA
8		Maximum Output Power	Input $\geq 30W@$ Class 4	25	28	30
9	Current Limit	output $\leq 30W@$ Class 4	-	600	650	mA
10	Current Limit Cut-Off Time	output $\leq 30W@$ Class 4	-	60	70	ms
11	Maintain Power Signature		5	-	10	mA

6. Port Output

The Port output can be connected directly to the centre-tap of an IEEE802.3at compliant data transformer or to the spare pair connection for 10/100BASE-T applications, as shown in Figure For 1000BASE-T (Gigabit) Ethernet applications all four cable pairs require magnetics, this is explained in more detail in application note .

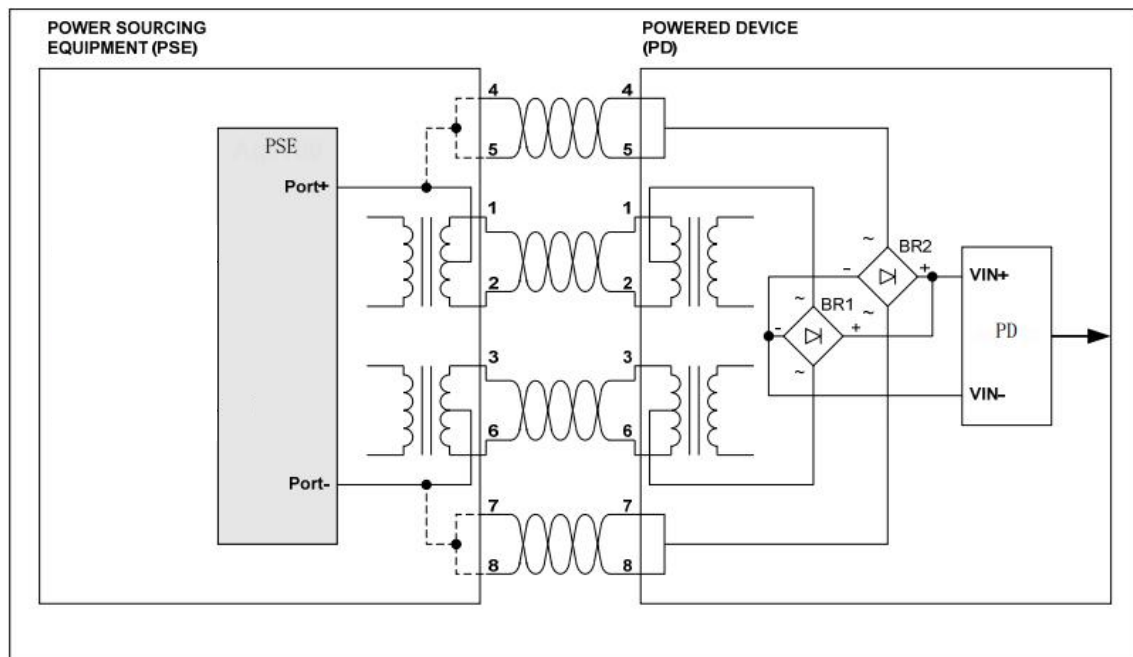

7. PSE Product naming rules

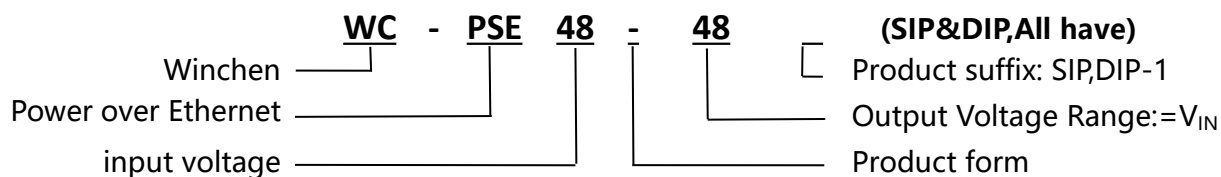

8. Typical applications

This module is used in PSE network cable to convert electric energy to DC-DC to the required voltage of equipment without affecting data signal transmission. It conforms to IEEE 802.3at standard and is used by all equipment terminals.

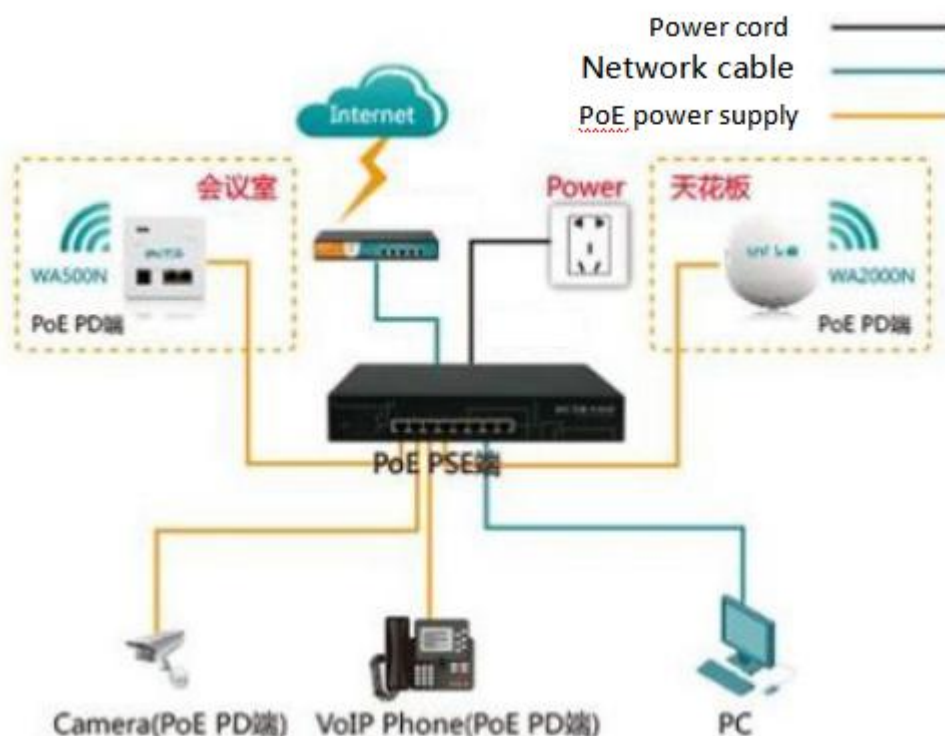

9. Signature and Classification

The WC-PSE48-48 will automatically perform the Signature and Classification, Figure 1 shows the timing sequence for a Type 1 Powered Device (PD) and Figure 2 shows the timing sequence for a Type 2 PD.

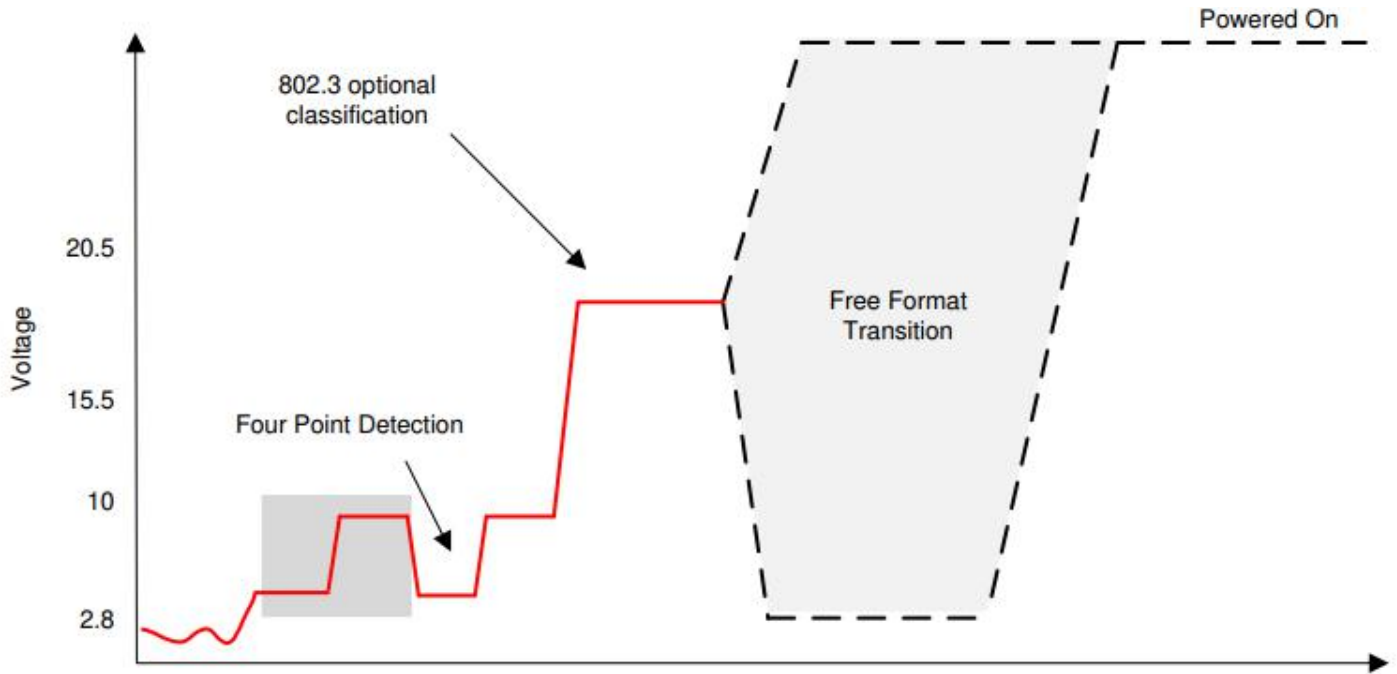

Figure 1. 802.3af with Classification

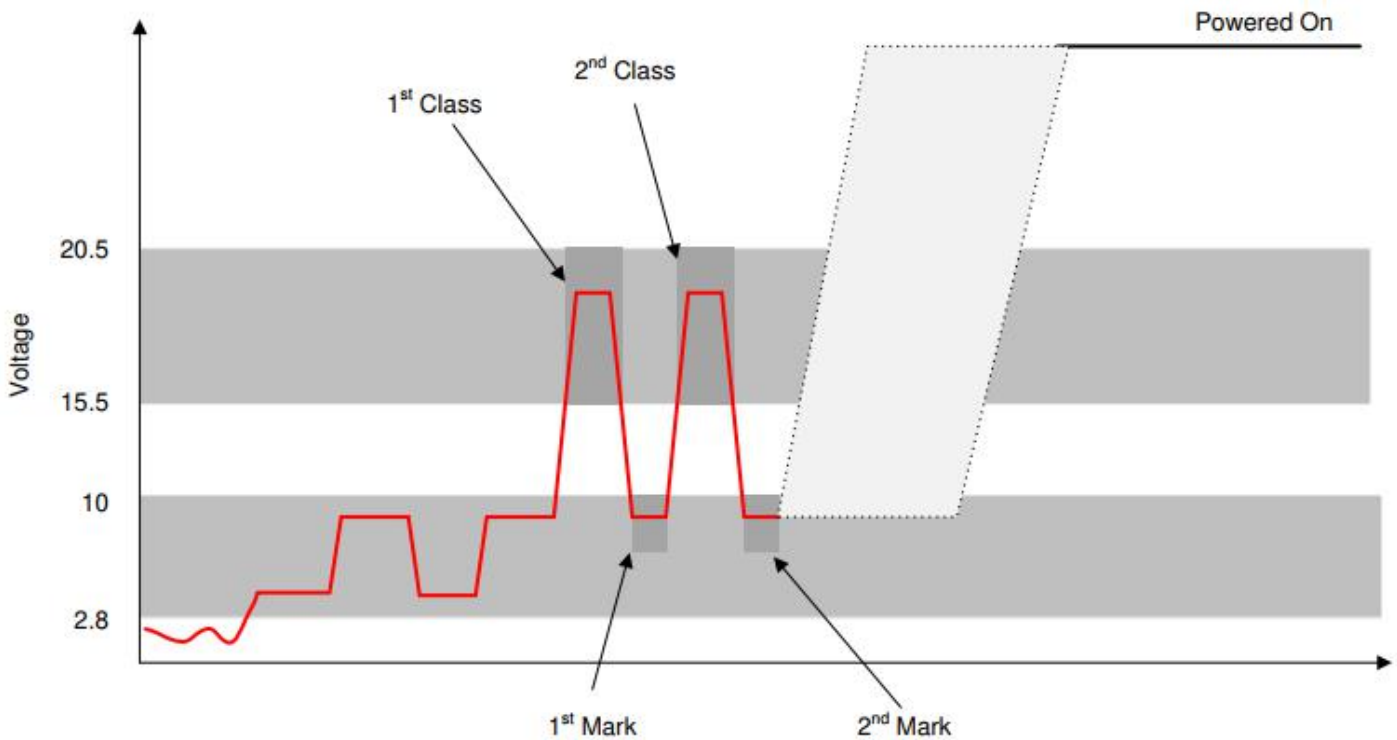

Figure 2. 802.3at with Classification

9.1 Power Classification

The IEEE802.3at separates the power handling into two basic categories "Type 1" and "Type 2". In simple terms Type 1 handles power requirements up to 15.4W and is comparable with the IEEE802.3af specification. Type 2 handles the power levels above this, which is commonly referred to as POE+.

Define criteria	Cable requirements	Grading parameters	Power Supply Characteristics
IEEE802.3at (PoE Plus)	CAT5 cable or CAT6 cable	Maximum power required for Class4 devices is 13W~25.5W	The DC voltage ranges from 48 to 57V, with a typical value of 48V. Typical operating current is 10~600mA; typical output power: 30W; Class4 rating supported by electrical equipment
IEEE802.3af (PoE)	CAT5 cable	Maximum power required for Class0 devices is 0~12.95W	The DC voltage ranges from 42 to 57V, with a typical value of 48V. Typical operating current is 10~350mA; typical output power: 15.4W; The overload detection current is 350~500mA. Provide 4 Class Power Requests for PD Devices ranging from 3.84 to 12.95W
		The maximum power required for Class1 devices is 0~3.84W	
		The maximum power required for Class2 devices is 3.85W~6.49W	
		The maximum power required for Class3 devices is 6.5W~12.95W	

Poe corresponding power level diagram

9.2 Signature Detection

To ensure that the does not apply power to a non PoE enabled device the Port output first checks for a valid PoE signature. The PD should present a nominal 25kΩ(19kΩ to 26.5kΩ) Signature resistance; if the does not see a valid signature then it will disconnect, wait approximately 2 seconds then try again, see below.

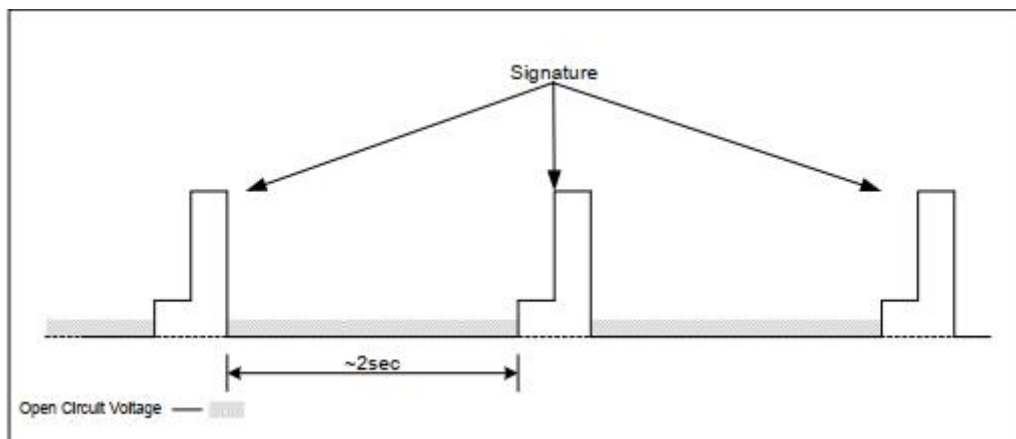

10. output characteristic

10.1 Maintain Power Signature

After successful completion of a valid signature (and classification), the module applies the main power supply to the port output. Once the main power supply is applied, the module continuously monitors the PD, and if the extracted current is below the detection threshold, the power is eliminated. If the output current of the module port is $\geq 10\text{mA}$, the output will remain on. If the output current of the port is $\leq 5\text{mA}$, the output will be turned off.

10.2 Output Current Limits

The module has over-current limit protection. If the output of the port continues to exceed the current limit, the output will be belching protection, and it will recover automatically after the output demand current is normal.

10.3 Input Protection

The WC-PSE48-48 has built-in Tranzorb diode across its input, to protect the module from transients from the power supply.

10.4 Short-Circuit Protection

WC-PSE48-48 not only has overcurrent protection but also has output short circuit protection.

11. Typical Characteristics

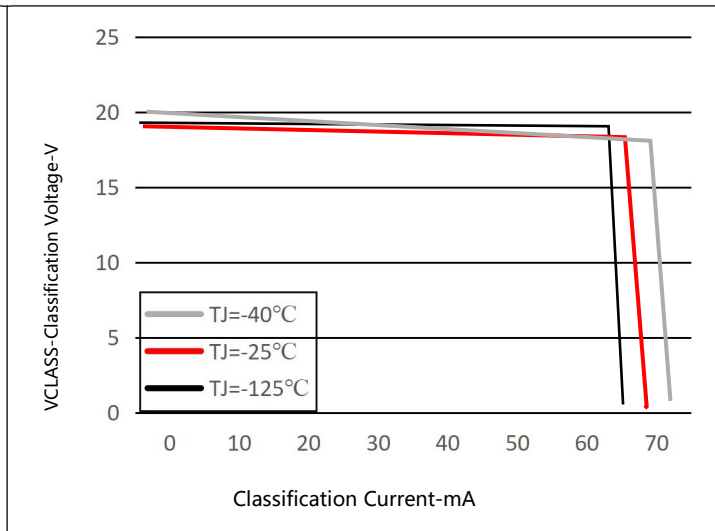
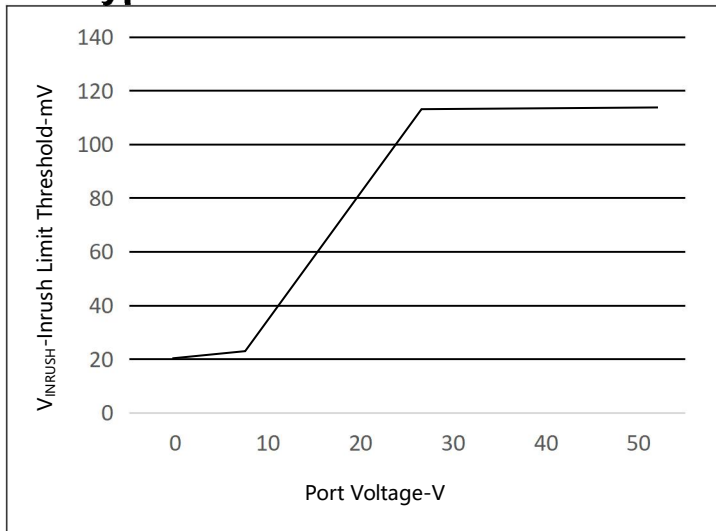

Inrush Current Limit Threshold vs Port Voltage

Classification Voltage vs Port Classification Current

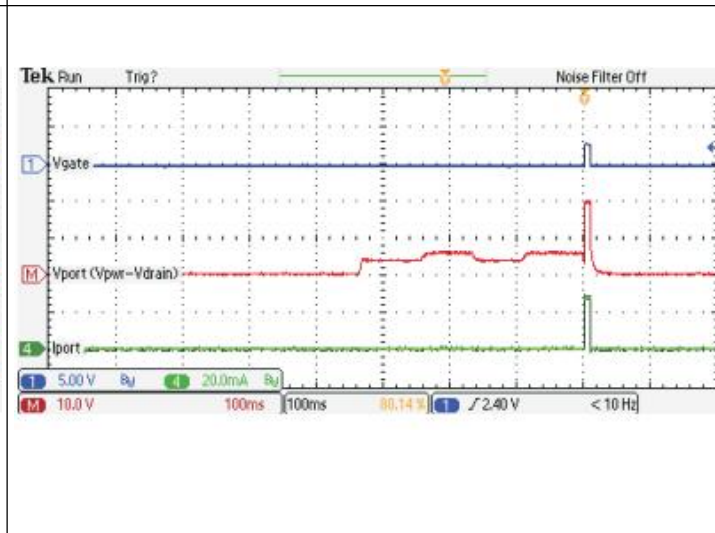
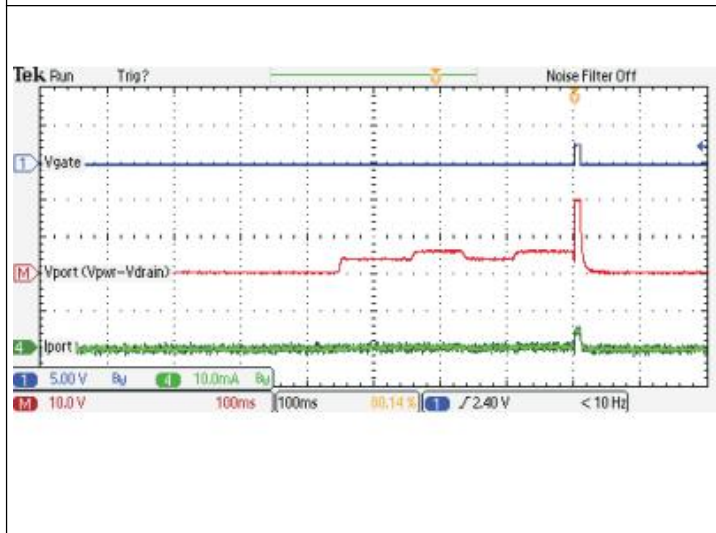

Valid PD Detection (25 kΩ and 0.1 μF) and CLASS 0 Classification

Valid PD Detection (25 kΩ and 0.1 μF) and CLASS 3 Classification

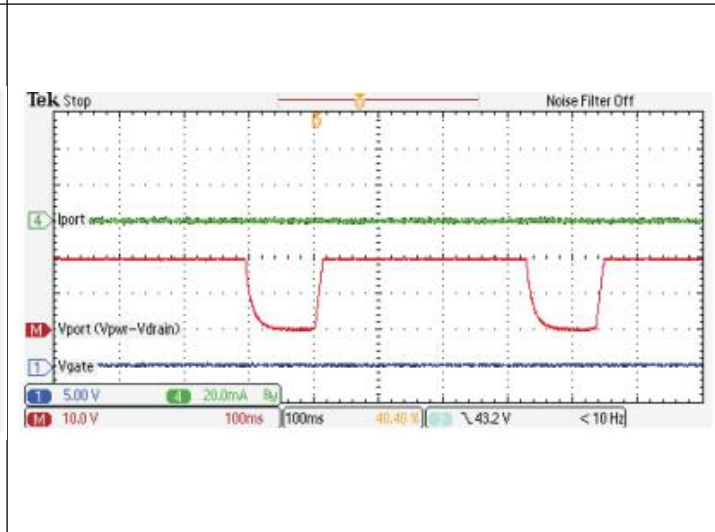
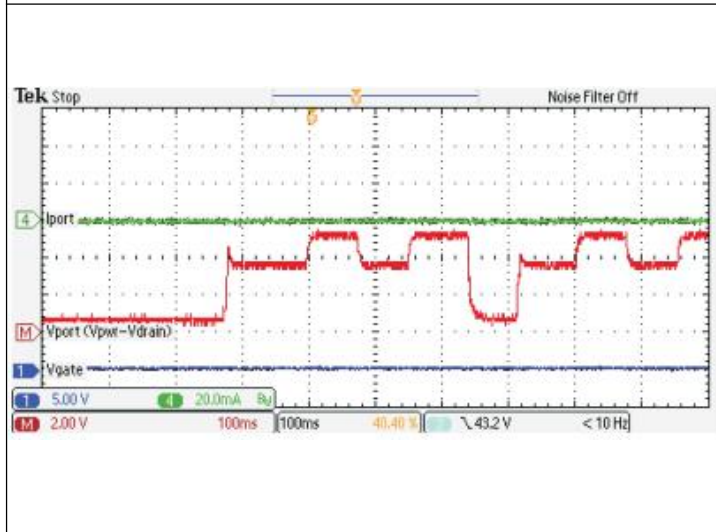

Detection with Invalid PD (15 kΩ and 0.1 μF)

Detection with Invalid PD (open circuit)

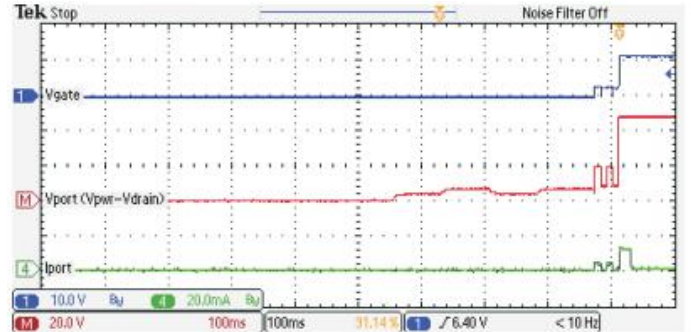
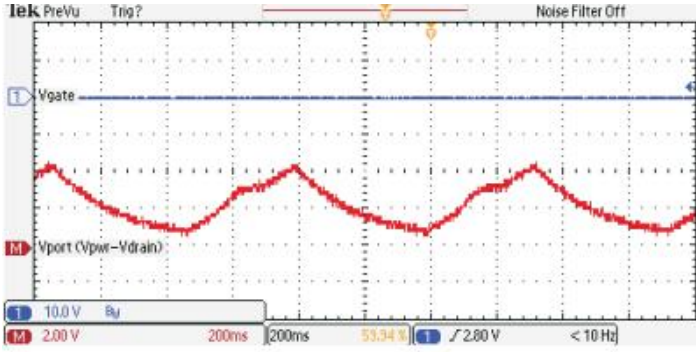

Detection with Invalid PD (25 kΩ and 10 μF)

Event Class and Startup with Valid PD

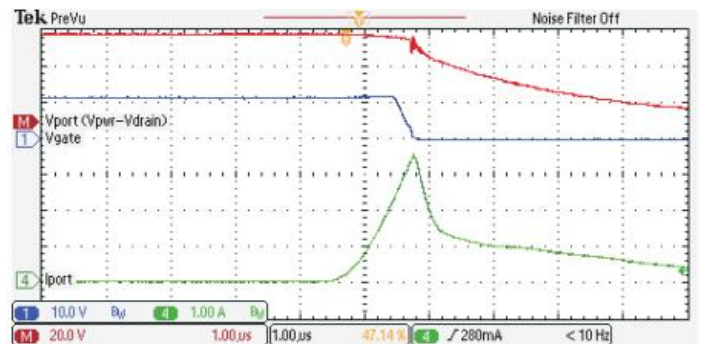
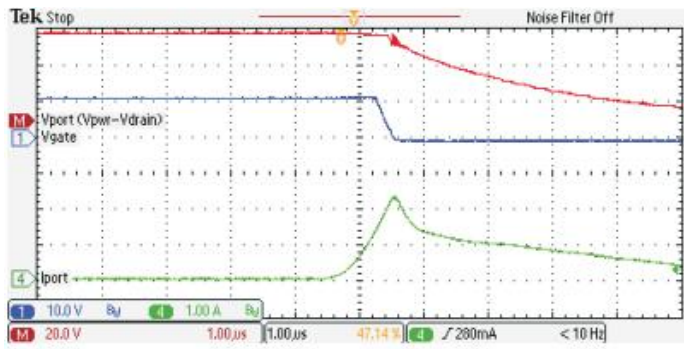

Rapid Response to a 1-Ω Short: 802.3af Mode

Rapid Response to a 1-Ω Short: PoE+ Mode

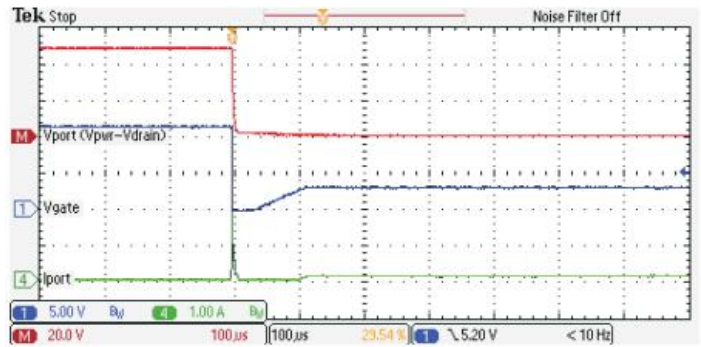
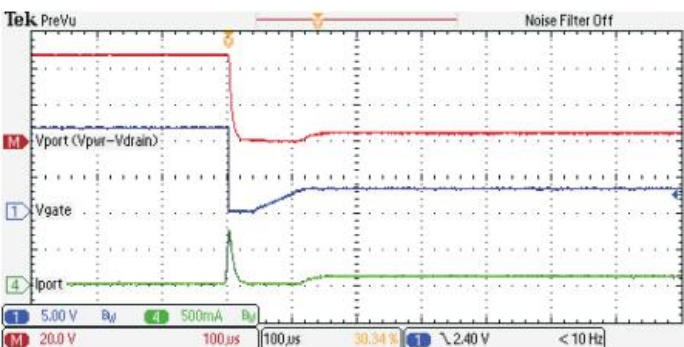

Response to a 50-Ω Load: 802.3af Mode

Response to a 25-Ω Load: PoE+ Mode

X-ON Electronics

Largest Supplier of Electrical and Electronic Components

Click to view similar products for [Ethernet Modules](#) category:

Click to view products by [Winchen](#) manufacturer:

Other Similar products are found below :

[I350T4V2](#) [GX-OD1612](#) [TDKEZW3](#) [V23993-USB1029A](#) [I350T4V2BLK](#) [I350T2V2BLK](#) [FC6A-PH1](#) [EM-ETH-GATEWAY-IFS](#) [EK1122](#)
[EL1018](#) [EL1809](#) [EL2622](#) [EL2904](#) [EL3052](#) [EL6021](#) [EL6224](#) [EL6631](#) [EL9011](#) [EL9100](#) [KL1002](#) [KL1104](#) [KL2602-0010](#) [KL3208-0010](#)
[KL6821](#) [KL9100](#) [KL9200](#) [X710T2L](#) [RY9012A0000GZ00#002](#) [X710T4LBLK](#) [7000-14561-7960150](#) [7000-44711-7960300](#) [7000-44711-](#)
[7960500](#) [7000-44711-7961000](#) [7000-74711-4780150](#) [7000-89701-7910500](#) [7000-P6241-P060300](#) [7000-P6241-P060500](#) [2352903-2](#) [BOXER-](#)
[6614-A1M-1110](#) [ED-593](#) [WC-PD13C033I-1](#) [EL2809-0015](#) [WC-PD30A012C](#) [NS8](#) [NS2](#) [NS4](#) [USR-K3](#) [USR-K2](#) [USR-TCP232-E2](#) [WC-](#)
[PD13S120B](#)