

SPRINT cable glands, metric

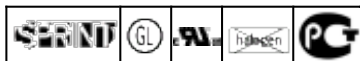

Protection class to EN 60 529: IP 68 to 5 bar (30 min)

Protection class to DIN 40 050-T9: IP 69K

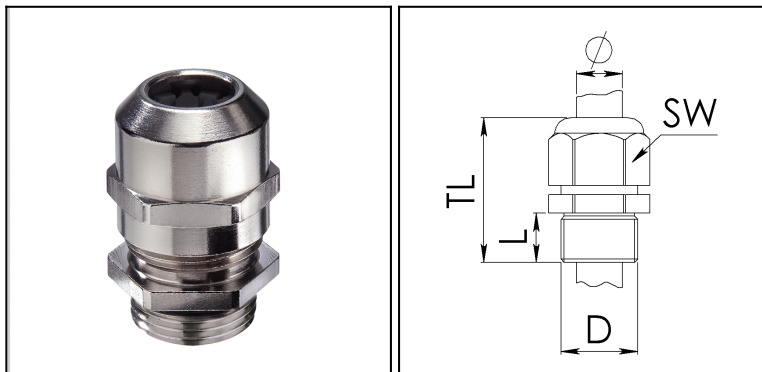



Temperature range: -40°C to 100°C, interm. up to approx. 120°C

Material:

- Cable gland: brass nickel-plated
- Clamping cage: polyamide
- Gasket: EPDM

Equipment:

- Maximum traction relief through WISKA patent lamella
- Seal-tight to enclosure rack through additional EPDM sealing ring
- Same sealing range and key width on all SPRINT-glands
- Also available with reduction insert, multiple sealing insert, special sealing insert and dust-protection gasket

Type	WISKA-No. Ni		 D mm	 mm	 mm	 SW mm	E1 mm	TL mm
EMSKV 12	10065000	50	M 12x1,5	5	3 - 7	16	18	23 - 30
EMSKV 16	10065001	50	M 16x1,5	5	4,5 - 10	20	22	26 - 34
EMSKV 20	10065002	50	M 20x1,5	6	6 - 13	24	27	29 - 37
EMSKV 25	10065003	50	M 25x1,5	7	9 - 17	29	32	33 - 42
EMSKV 32	10065004	25	M 32x1,5	8	13 - 21	36	40	36 - 44
EMSKV 40	10065005	10	M 40x1,5	8	16 - 28	46	51	44 - 55
EMSKV 50	10065006	10	M 50x1,5	9	21 - 35	55	61	51 - 62
EMSKV 63	10065007	10	M 63x1,5	10	34 - 48	68	75	56 - 67
EMSKV 75	10100865	1	M 75x1,5	12	48 - 62	82	90	67 - 81

X-ON Electronics

Largest Supplier of Electrical and Electronic Components

Click to view similar products for [Wire Identification](#) category:

Click to view products by [Wiska](#) manufacturer:

Other Similar products are found below :

[CU6337-000](#) [CU6342-000](#) [FCA-410-12](#) [11631010](#) [1-1768037-1](#) [1-1768037-2](#) [1-1768050-0](#) [PXLK-VI](#) [Q62184-1](#) [A64304-000](#) [QMT221](#)
[HK032WE1NF038B](#) [1330-0519-10](#) [1395199-1](#) [1395200-1](#) [1395202-1](#) [DMVF050WE-300S6](#) [D-SCE-1K-2.4-50-4-CS7834](#) [1538738-1](#)
[E90935-000](#) [EC1238-000](#) [EC1465-000](#) [EC1855-000](#) [EC1859-000](#) [EC1863-000](#) [EC5415-000](#) [EC7277-000](#) [EC7352-000](#) [EC7603-000](#)
[EC7707-000](#) [EC7735-000](#) [EC7768-000](#) [EC7828-000](#) [EC7854-000](#) [EC7952-000](#) [EC8128-000](#) [1768037-8](#) [1768041-7](#) [NC-127191-10-9](#)
[HS048WE2NF038B](#) [C03232-000](#) [HTCM-SCE-14-4H-9](#) [HTMS-3/16-9](#) [HT-SCE-1/4-2.0-4](#) [HT-SCE-3/16-2.0-4](#) [HTTMS-1/2-1.50-9](#) [HTTMS-](#)
[CM-1/2-4H-9](#) [HX-SCE-19.0-50-9](#) [HX-SCE-6.4-50-4](#) [C25254-000](#)