

WISKA COMBI 308

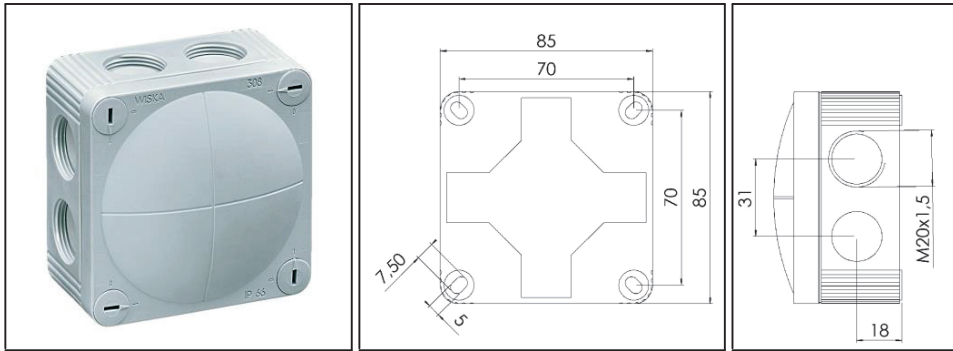

Protection class to EN 60 529:

IP 66

Flame protection:

Glow wire test 750 C acc. to EN 60695-2-11

Temperatures during installation:

-5°C to 60°C

Temperature range of material:

-30°C to 100°C, intermittent up to approx. 120°C

Voltage:

400 V

Material:

Polypropylene, reinforced glass fibre; Sealing: thermoplastic elastomere

Terminals/poles:

4 mm²

Fixing:

With mounting clip or 4 internal openings outside of the sealing area

Equipment:

8 elastic self-sealing membranes for cable entry without mechanical devices

- 8 integrated M 20 threads, no locknuts necessary

- 4 captive quick-release lid screws

- Incl. mounting clip for snap-on fixing

- Colour RAL 7035 light grey







- .../S = black

- .../W = white

Accessories:

- DIN RAIL KIT 108, 308: Rail TS 15 + Fixing material, WISKA-No. 10060362

- EC 308 Earthing plate: WISKA No. 10101473

Type	WISKA-No.		 mm		L x B x H external / außen mm
COMBI 308/5	10060401	5/100	3 - 12		85 x 85 x 51
COMBI 308/5/S	10060580	5/100	3 - 12		85 x 85 x 51
COMBI 308/5/W	10060611	5/100	3 - 12		85 x 85 x 51
DIN RAIL KIT 308	10060362	1			

X-ON Electronics

Largest Supplier of Electrical and Electronic Components

Click to view similar products for [wiska manufacturer](#):

Other Similar products are found below :

[10066414](#) [10065002](#) [EMUG 32 GRY](#) [RE0400](#) [COMBI 1010/5/S](#) [COMBI 108/5](#) [ESMU 20](#) [COMBI 308/5/S](#) [COMBI 308/5](#) [10066124](#)
[ESVG25 BLK](#) [EMMU 20](#) [10066120](#) [EMUG 25 BLK](#)