



DATASHEET

-Preliminary-

Surface Acoustic Wave Filter

- **Application : BAND20 DPX**
- **Model : SFX806BYH02**
- **Center Frequency : 806.0 [MHz]**



WISOL CO., LTD.

373-7, GAJANG-DONG, OSAN-SI
GYUNGGI-DO, KOREA, 447-210

<http://www.wisol.co.kr>

E-mail: sales@wisol.co.kr

1. OUTLINE DRAWING & RECOMMENDED PCB

[Unit: mm]

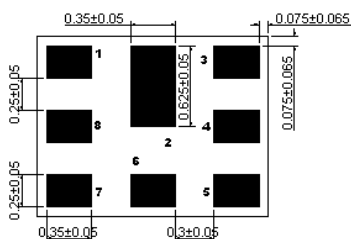
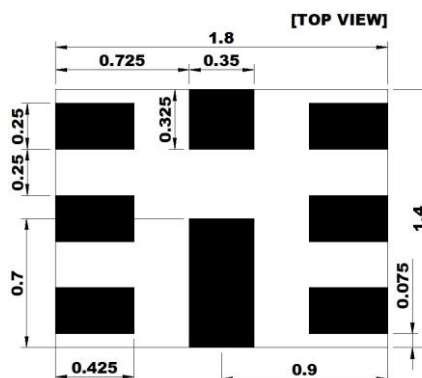
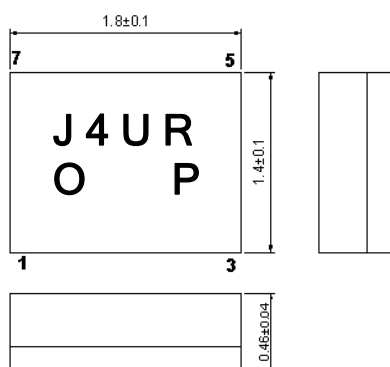

No.	Function
1	Rx Output
3	Tx Input
6	Antenna
2, 4, 5, 7, 8	GND

2. TEST FIXTURE

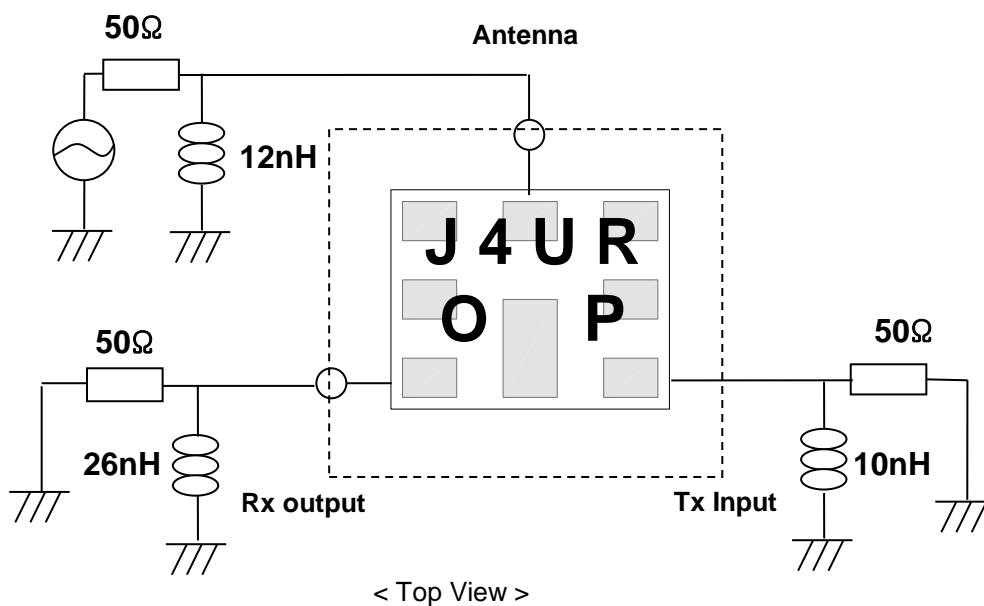

3. PERFORMANCE

3-1. MAXIMUM RATINGS

CHARACTERISTICS	RATINGS	Units
DC Permissive Voltage	5	V
Maximum Input Power	0.8	W
Operating Temperature Range	- 30 ~ + 85	°C
Storage Temperature Range	- 40 ~ + 85	°C

3-2. ELECTRICAL CHARACTERISTICS

3-2-1. TABLE

Ta = -30 ~ +85°C

Item	CONDITION [MHz]	UNIT	RATING		
			Min.	Typ.(25°C)	Max.
TX → ANTENNA					
Insertion Loss	832~ 862	dB	-	1.6	TBD
Inband Ripple	832~ 862	dB	-	0.9	TBD
VSWR	832~ 862	-	-	1.8	TBD
Absolute Attenuation	10~771	dB	TBD	36	-
	771~791	dB	TBD	49	-
	791~820	dB	TBD	54	-
	820~821	dB	TBD	52	-
	821~827	dB	TBD	5.6	-
	873~903	dB	TBD	8.4	-
	925~960	dB	TBD	40	-
	1565~1606	dB	TBD	46	-
	1664~2170	dB	TBD	45	-
	2400~2620	dB	TBD	44	-
	2620~2690	dB	TBD	44	-
	3328~3448	dB	TBD	40	-
4000~6000	dB	TBD	20	-	
Termination Impedance : INPUT / ANTENNA			50Ω // 10[nH] 50Ω // 12[nH]		
ANTENNA → RX					
Insertion Loss	791 ~ 821	dB	-	1.9	TBD
Inband Ripple	791 ~ 821	dB	-	0.8	TBD
VSWR	791 ~ 821	-	-	1.8	TBD

Absolute Attenuation	10~770	dB	TBD	40	-
	770~782	dB	TBD	27	-
	832~862	dB	TBD	55	-
	873~903	dB	TBD	41	-
	1623~1683	dB	TBD	43	-
	2373~2570	dB	TBD	39	-
	4900~6000	dB	TBD	26	-
Termination Impedance : ANT / OUTPUT			50Ω // 12nH] 50Ω // 26[nH]		
TX → RX					
Isolation between Tx and Rx	791~820	dB	TBD	57	-
	820~821	dB	TBD	57	-
	832~862	dB	TBD	57	-
	1574 ~ 1577	dB	TBD	54	-
	1664 ~ 1724	dB	TBD	53	-
	2496 ~ 2586	dB	TBD	49	-

3-2-2. GRAPH

3-2-2-1. Tx→Ant, Transmission Characteristics

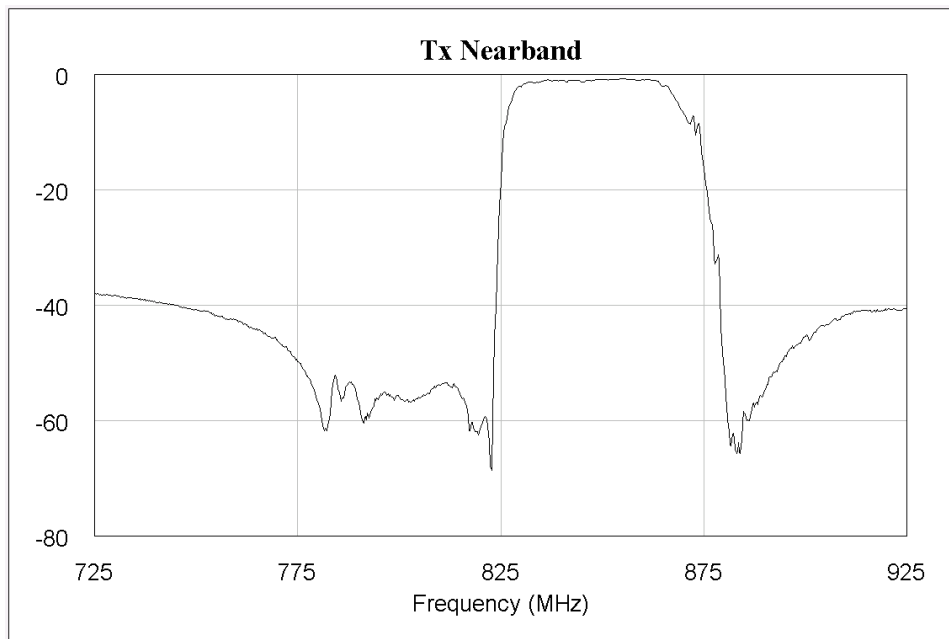

3-2-2-2 Ant→Rx Transmission Characteristics

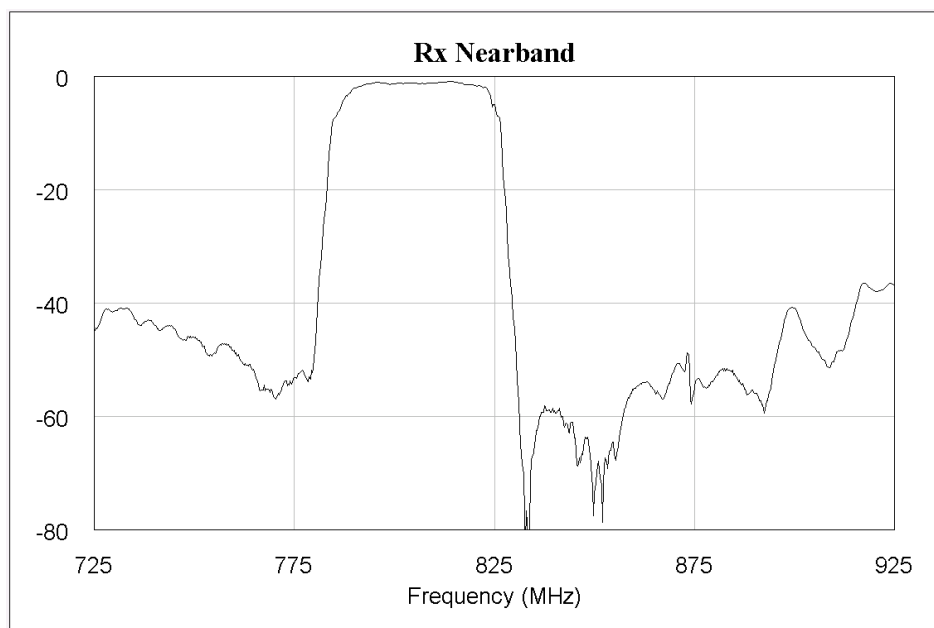

3-2-2-3. Tx→Rx Isolation Characteristics

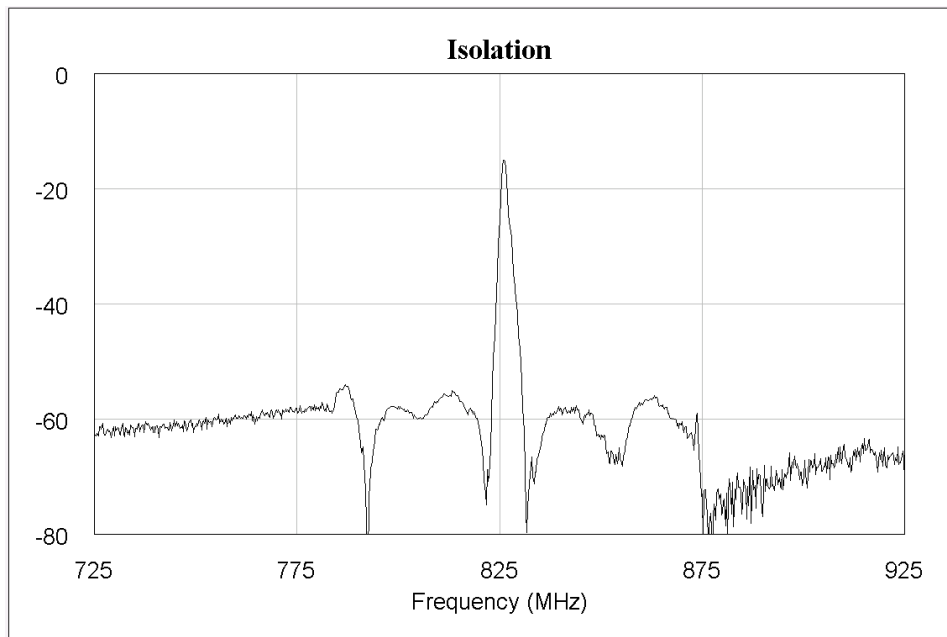

3-2-2-4. Wideband Tx→Ant Transmission Characteristics

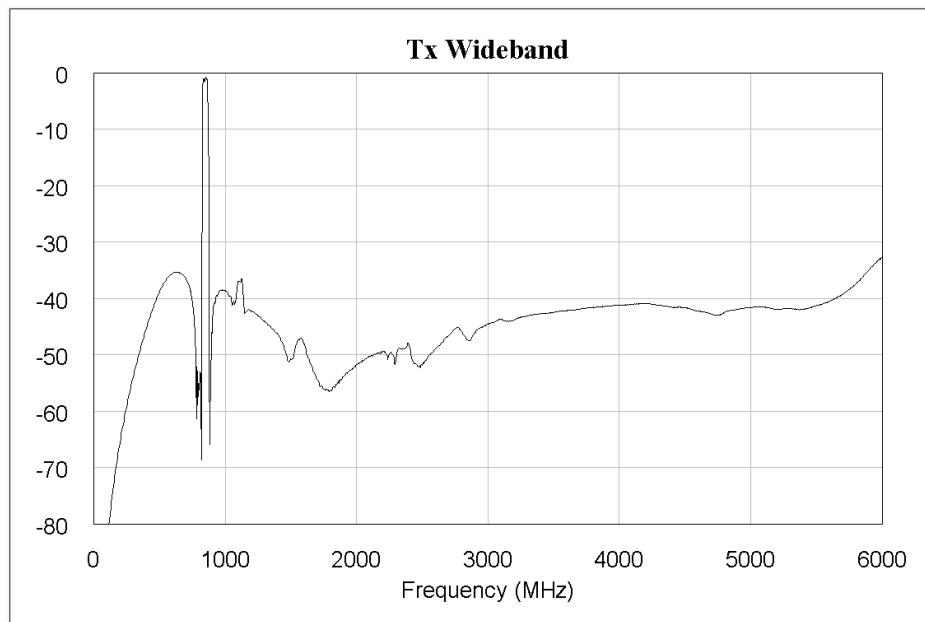

3-2-2-5. Wideband Ant→Rx Transmission Characteristics

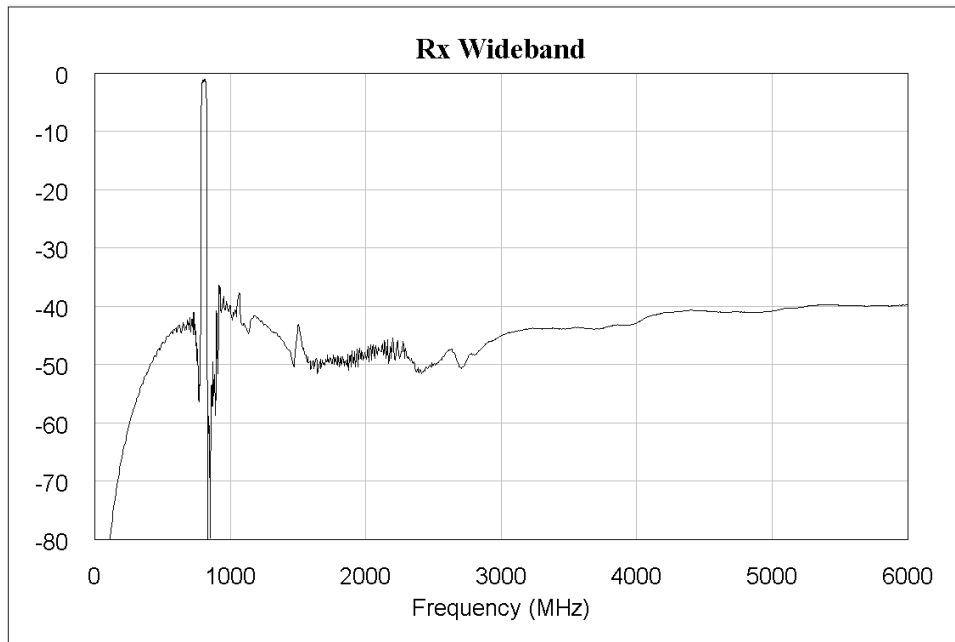

3-2-2-6. Smith chart

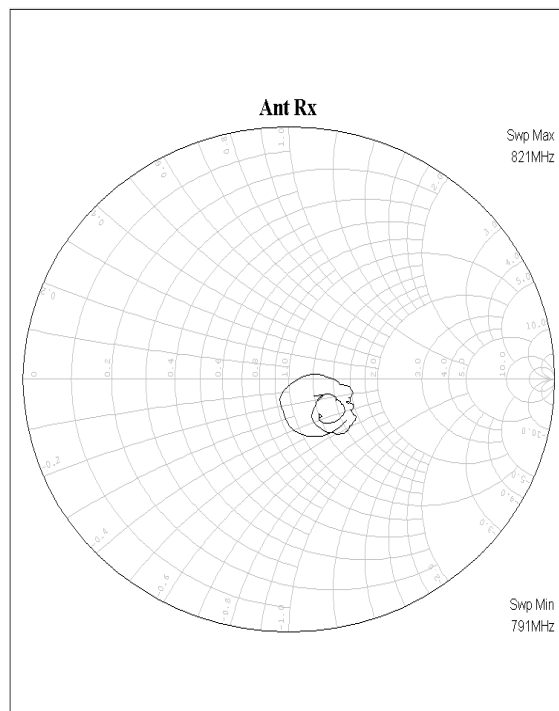
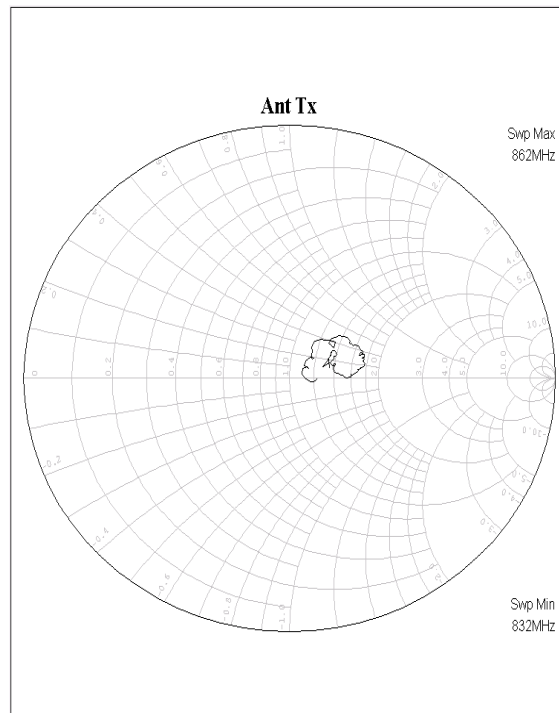

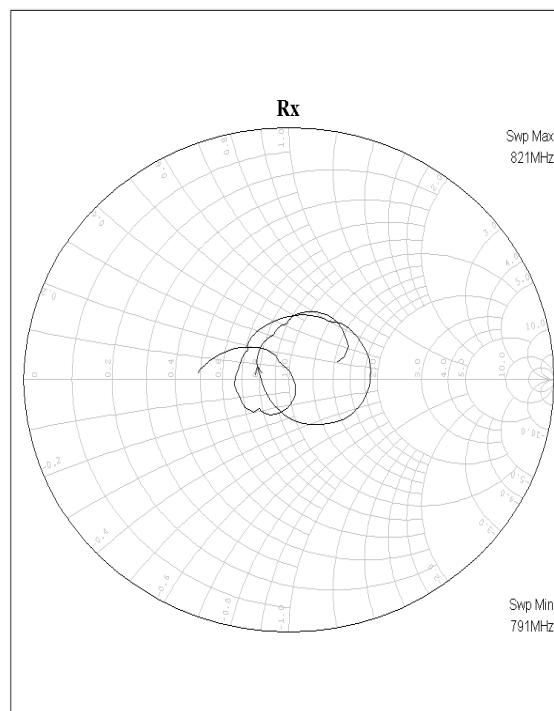
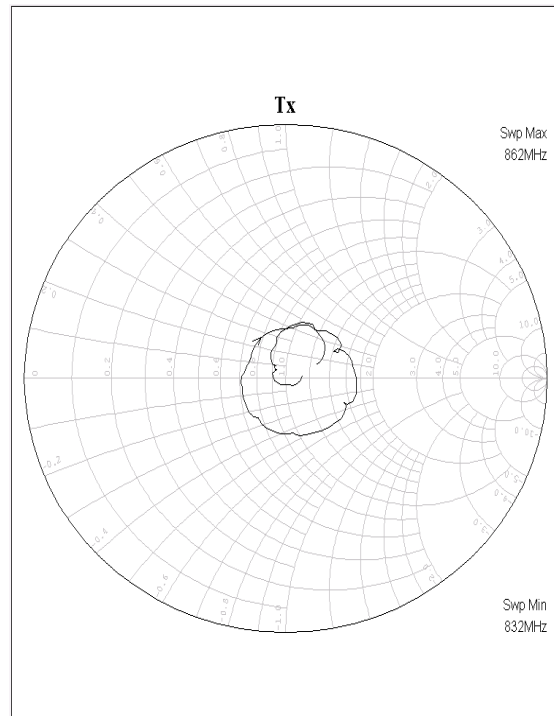

4. PACKING

4-1. DIMENSIONS

- Carrier Tape [Unit: mm]

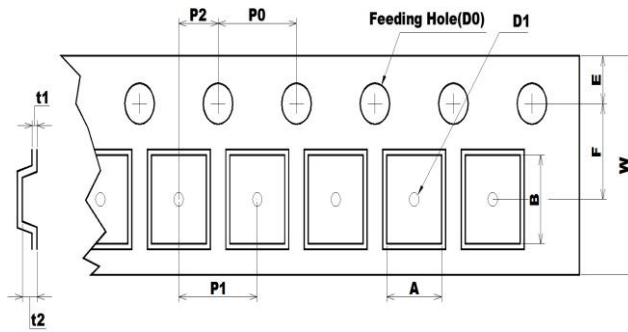

A	B	D0	D1
1.60 +0.05 -0.05	2.0 +0.05 -0.05	Ø1.55 +0.05 -0.05	Ø1.00 MIN
E	F	P0	P1
1.75 +0.10 -0.10	3.5 +0.05 -0.05	4 +0.10 -0.10	4 +0.10 -0.10
P2	t1	t2	W
2 +0.05 -0.05	0.25 +0.05 -0.05	0.80 +0.05 -0.05	8 +0.10 -0.10

- Reel [Unit: mm]

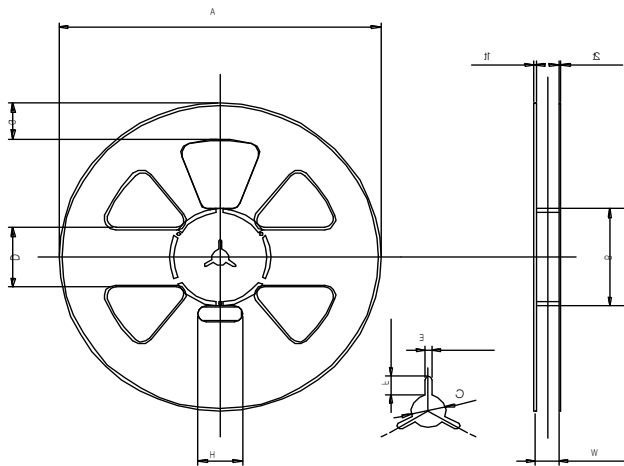

A	B	C	D
Ø258.0 +1.0 -0.5	Ø81.0 +1.0 -1.0	Ø13.0 +0.5 -0.5	50.0 +0.8 -0.8
E	F	G	H
2.2 +0.3 -0.3	7.0 +0.5 -0.5	30.0 +0.8 -0.8	35.0 +1.0 -1.0
t1	t2	W	
1.8 +0.5 -0.5	1.5 +0.5 -0.5	9.0 +1.0 -0.5	

- The product shall be packed properly not to be damaged during transportation and storage.

4-2. REELING QUANTITY

10 inch reel: 8,000 pcs/reel

4-3. TAPING STRUCTURE

The tape shall be wound around the reel in direction shown below.

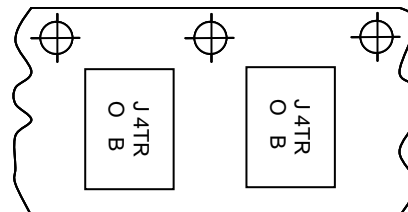
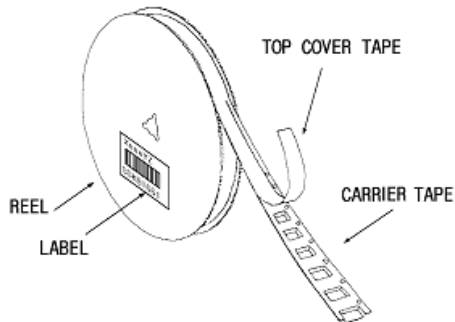

Tape Running direction
→

X-ON Electronics

Largest Supplier of Electrical and Electronic Components

Click to view similar products for [Signal Conditioning](#) category:

Click to view products by [WISOL](#) manufacturer:

Other Similar products are found below :

[MAPDCC0001](#) [MAPDCC0004](#) [PD0409J5050S2HF](#) [HHS-109-PIN](#) [AFS14A30-2185.00-T3](#) [AFS14A35-1591.50-T3](#) [DS-323-PIN](#) [DSS-313-PIN](#) [B39321R801H210](#) [1A0220-3](#) [JP510S](#) [LFB212G45SG8C341](#) [LFB322G45SN1A504](#) [LFL182G45TC3B746](#) [SF2159E](#) [30057](#)
[AFS1575.42S4-T](#) [FM-104-PIN](#) [CER0813B](#) [MAPDCC0005](#) [3A325](#) [40287](#) [41180](#) [ATB3225-75032NCT](#) [BD0810N50100AHF](#) [JHS-115-PIN](#)
[DC0710J5005AHF](#) [DC2327J5005AHF](#) [43020](#) [LFB2H2G60BB1C106](#) [LFL15869MTC1B787](#) [X3C19F1-20S](#) [XC3500P-20S](#) [10013-20](#)
[SF2194E](#) [CDBLB455KCAX39-B0](#) [TGL2208-SM, EVAL](#) [RF1353C](#) [051157-0000](#) [PD0922J5050D2HF](#) [1E1305-3](#) [1F1304-3S](#) [1G1304-30](#)
[B0922J7575AHF](#) [10017-3](#) [TP-103-PIN](#) [BD1222J50200AHF](#) [BD1722J50100AHF](#) [2450DP39K5400E](#) [BD0810J50150AHF](#)