



Huizhou Wisva Optoelectronics Co.,Ltd

惠州市慧昊光电有限公司

Add: 5 Floor, Building 6, science and Technology Park, Longhai three road, Huiyang District, Huizhou China

地址: 惠州市惠阳区龙海三路中海科技园6栋5楼

Tel/Tel: 0752-5288039

Web: <http://www.wisvaled.com>

Product Specification

产品规格书

Item No.:

----- HH-SRGB60F010W24-5050 DMX

产品型号: _____

Series: Digital Series

产品系列: 幻彩系列

Confirmation/制作	Approval/审核	Audit/确认	Date/日期	Version/版本
			2018/10/31	1.0

Features(特征)

Each Segment including an SM16511BK Chip.

每一剪包含一个SM16511BK芯片.

Each Segment (6 LEDs) has the same color.

每一剪(6颗灯珠)拥有相同的颜色.

24Vdc input, less voltage dropping and brightness difference.

24V输入, 更小的压降和亮度差.

Adhesive 3M or Tesa Tape for quick installation.

3M/德萨双面胶, 快速安装.

Picture(图片)



Dimensions(尺寸)

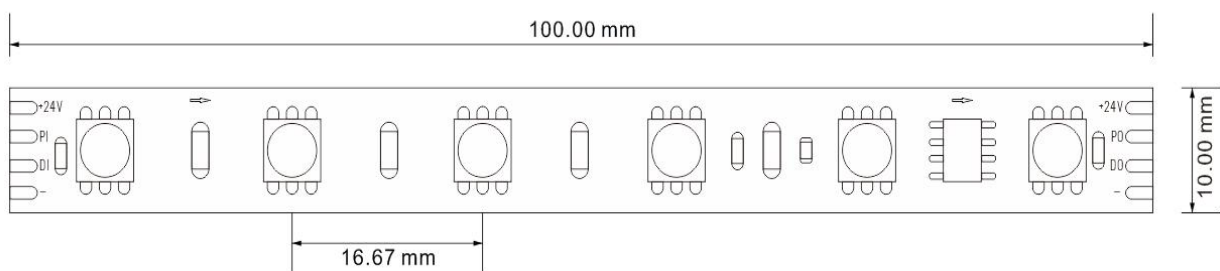

Specifications(参数)

Item NO. 产品型号	HH-SRGB60F010W24-5050 DMX			
Light Source 使用光源	5050 RGB			
LED Qty/M LED灯数/米	60			
Input Voltage 输入电压	24Vdc			
PCB 板子	10mm width, 2oz			
CRI 显色指数	80+			
Color 颜色	Red	Green	Blue	Cold White
Power 功率	4.8W/M	4.8W/M	4.8W/M	14.4W/M
Brightness 亮度	81.1Lm/M	229.9Lm/M	37.4Lm/M	404.6Lm/M
Efficiency 光效	16.9Lm/W	47.9Lm/W	7.8Lm/W	28.1Lm/W
Length 长度	5,000 mm			
Size 尺寸	Wdith: 10mm, Height: 2mm			
Cutting Length 裁剪长度	100mm			
Lifespan 工作时长	50,000 H			
Working Temperature 工作温度	-20°C - 45°C			
Storage Temperature 储存温度	-20°C - 55°C			
Warranty 质保	3年			

* The above measurements of watts, brightness and efficiency allowance tolerance $\pm 10\%$.





* 以上功率和光效允许误差范围是 $\pm 10\%$.

* The above measurements are based on IP20.

以上测量均基于IP20.

Waterproof Ways(防水方式)

Available waterproof ways:

Waterproof Ways	IP Rating	Details
防水方式	防水等级	细节说明
	IP54	PU or Silicone glue on the surface of the led strips. 表面滴PU或者硅胶
	IP65	Heat Shrink tube or Silicone tube for led strips. 热缩套管或者硅胶套管防水
	IP67	Hollow integrated silicone glue. 挤出型硅胶防水, 中空
	IP68	Solid Integrated Silicone glue, or silicone glue with silicone tube 挤出型一体化硅胶防水, 实心; 或者灌胶(硅胶套管里加硅胶)

Installation Ways(安装方式)

Compatible with LT-800 DMX master.

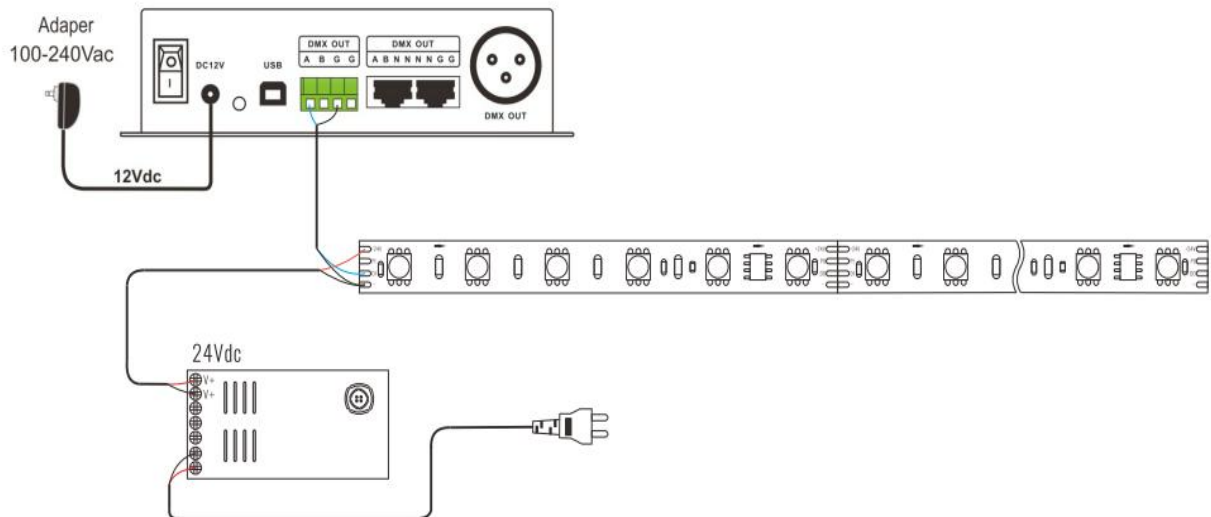

The Max installation length is 5 meters, for over 5 meters, recommend connected in parallel.

最大安装长度是5米, 超过5米的话建议并联.

* Usually most of the power supply has a efficiency between 80%-95%, so when choosiing the power supply, the total watts of the strips should be smaller than 80% of the rate power of the LED Strip Lights.

通常大部分电源的输出效率大概在80%-95%, 所以当选择电源时, 应注意灯带的输出功率必须小于电源额定功率的80%.

Applications(应用)

*Ideal for decorating stage, KTV and bars etc.

Package(包装)

①) 5 meters per roll.

5m一卷.

②) Each roll packed with anti-static bags, and label on it.

每一卷放入静电袋中, 静电袋表面贴标签.

③) 25 rolls into a small box.

25卷放入一个小箱子中.

④-⑤) 2 small boxes into a large carton 520*320*300mm.

2个小箱放入一个大箱.

⑥) Delivery.

发货.

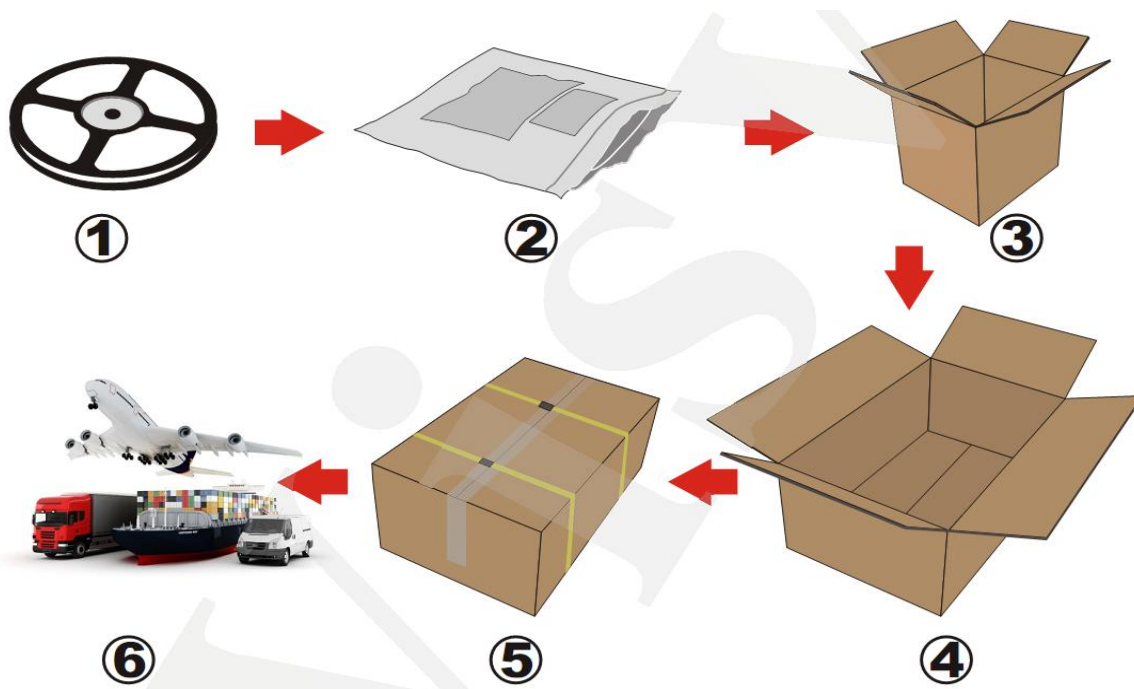

X-ON Electronics

Largest Supplier of Electrical and Electronic Components

Click to view similar products for [LED Lighting Bars and Strips](#) category:

Click to view products by [WISVA OPTOELECTRONICS](#) manufacturer:

Other Similar products are found below :

[ZLF0310W62524](#) [LF1D-F2F-2W-300](#) [00215258](#) [HH-SWW320F010W12-COB IP20](#) [HH-SWW320F010W24-COB IP20](#) [HH-SWW528F210W12-COB IP65](#) [HH-SG528F010W24-COB IP20](#) [LF2D-EN2F-2W-A](#) [LFBHL-SW827-24V-8S63-20](#) [N006120BC1LZ \(GOLDEN YELLOW\)](#) [S010060CB1LZ \(NEUTRAL WHITE IP65\)](#) [S010060CC1LZ \(WARM WHITE IP65\)](#) [2633830000](#) [HH-SX72F008W24-2835 CW WHITE PCB IP20](#) [HH-SX180F010W24 -2835 WW WHITE PCB IP20](#) [HH-SX72F008W24-2835 NW WHITE PCB IP20](#) [HH-SX144F008W24 -2835 NW WHITE PCB IP20](#) [HH-SX180F010W24 -2835 NW WHITE PCB IP20](#) [HH-SX144F008W24 -2835 CW WHITE PCB IP20](#) [HH-SX144F008W24 -2835 WW WHITE PCB IP20](#) [HH-SX180F010W24 -2835 CW WHITE PCB IP20](#) [N008120BB1LZ \(BLUE\)](#) [00219015](#) [10001611](#) [10001612](#) [10001613](#) [10001617](#) [10001618](#) [10001619](#) [10001622](#) [10001623](#) [10001655](#) [10001657](#) [10001664](#) [10001670](#) [10001675](#) [10001681](#) [10001683](#) [10001690](#) [PUUA-100LLL-NK2P](#) [QAUR1161L030](#) [HC-F12V-3535 PCBA](#) [HC-F12V-F50-3L-WS2811](#) [HC-F12V-WS2811-3535](#) [HC-F5V-144L-144LED-B-WS2813 IP20](#) [HC-F5V-144L-144LED-B-WS2813 IP65](#) [HC-F5V-144L-144LED-W-WS2813 IP20](#) [HC-F5V-30L-30LED-B-WS2813 IP20](#) [HC-F5V-30L-30LED-W-WS2813 IP20](#) [HC-F5V-60L-60LED-B-WS2813 IP20](#)