



Huizhou Wisva Optoelectronics Co.,Ltd

惠州市慧昊光电有限公司

Add: 5 Floor, Building 6, science and Technology Park, Longhai three road, Huiyang District, Huizhou China  
地址: 惠州市惠阳区龙海三路中海科技园6栋5楼  
Tel/Tel: 0752-5288039 Web: http://www.wisvaled.com

# Product Specification

产品规格书

Item No.:

HH-SX144F008W24-2835  
产品型号: \_\_\_\_\_

Series: High Efficiency Series

产品系列: 高光效系列

Confirmation/制作	Approval/审核	Audit/确认	Date/日期	Version/版本
			2021/12/14	2.0

## Features(特征)

Using SMD 2835 as light source, high efficiency and cost-effective.

使用2835作为光源, 高光效高性价比.

Efficiency up to 160Lm/w at Ra90, 200Lm/w at Ra80.

显指90光效达到160Lm/W, 显指80光效达到200Lm/W.

**The efficiency reaches level B for the newest ErP standard.**

**光效可达最新ErP欧规的等级B标准。**

24Vdc input, less voltage dropping compared to 12Vdc input.

24Vdc输入, 比起12Vdc有更小的压降.

Support for DALI, 0/1-10V, PWM dimming ways.

支持DALI, 0/1-10V, PWM等调光方式

## Picture(图片)



## Dimensions(尺寸)

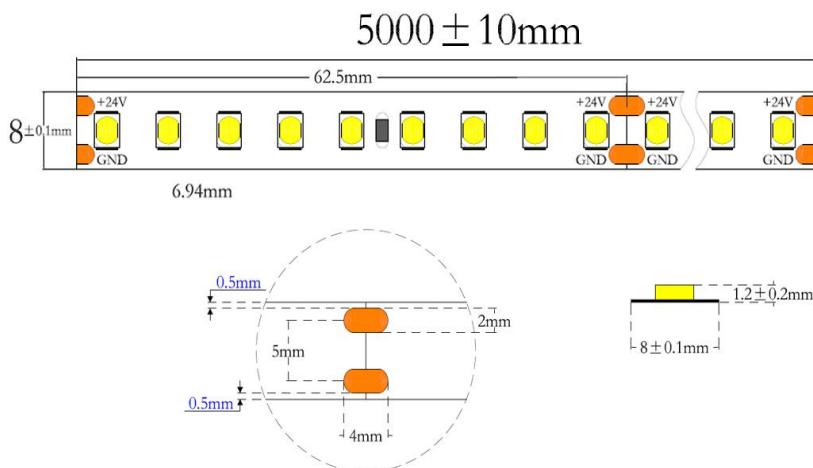

## Specifications(参数)

Item NO.	HH-SX144F008W24-2835					
产品型号	HH-SX144F008W24-2835					
Light Source	2835					
使用光源	2835					
LED Qty/M	144					
LED灯数/米	144					
Input Voltage	24VDC					
输入电压	24VDC					
PCB	8mm/2oz					
板子	8mm/2oz					
Length	5,000 mm					
长度	5,000 mm					
Size	Wdith: 8mm, Height: 1.2mm					
尺寸	Wdith: 8mm, Height: 1.2mm					
Cutting Length	62.5mm					
裁剪长度	62.5mm					
Lifespan	50,000 H					
工作时长	50,000 H					
Working Temperature	-20°C - 40°C					
工作温度	-20°C - 40°C					
Storage Temperature	-20°C - 45°C					
储存温度	-20°C - 45°C					
Warranty	3 YEARS					
质保	3 YEARS					
Power	6W/m					
功率	6W/m					
Ra	80+			90+		
显色指数	80+			90+		
CCT	2700K	3000K	4000-6000K	2700K	3000K	4000-6000K
色温	2700K	3000K	4000-6000K	2700K	3000K	4000-6000K
Brightness(Lm)	1020	1080	1200	810	870	960
亮度(流明)	1020	1080	1200	810	870	960
Efficiency(Lm/W)	170	180	200	135	145	160
光效(流明/瓦)	170	180	200	135	145	160
Installation Length	4m					
安装长度	4m					

\* The above measurements of watts, brightness and efficiency allowance tolerance  $\pm 10\%$ .

\* 以上功率和光效允许误差范围是 $\pm 10\%$ .

\* The above measurements are based on IP20.

以上测量均基于IP20.

## Brightness Curve(亮度曲线)

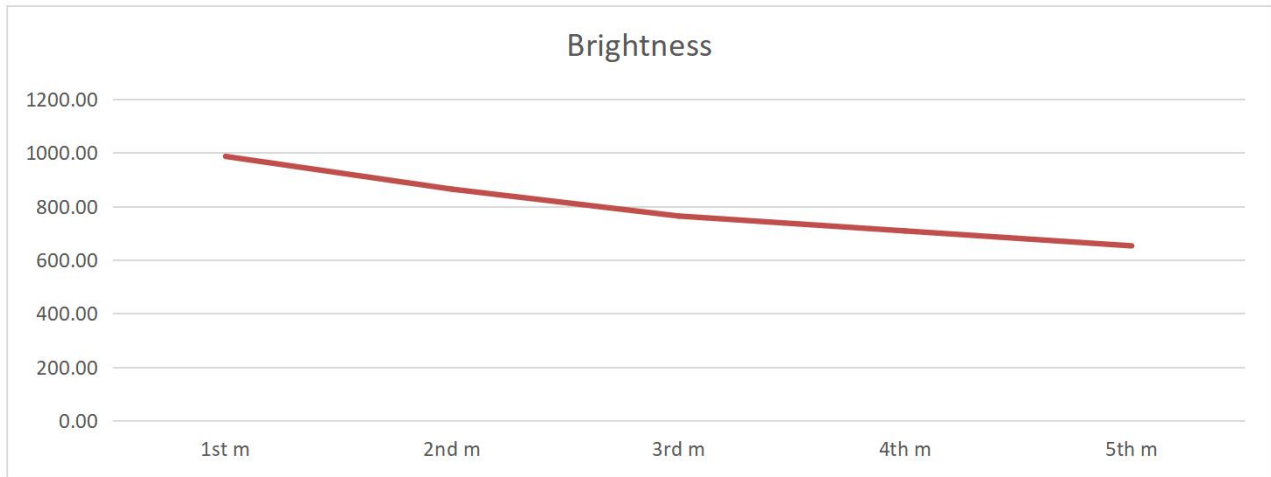

Length	1st m	2nd m	3rd m	4th m	5th m
Volage	23.87	23.76	23.67	23.62	23.57
Lumen	986.63	864.14	763.91	708.23	652.55
Dropped	0.00%	-12.42%	-22.57%	-28.22%	#####

\* The above chart shows the voltage drop and brightness difference in 5 meters.

以上图表显示5米内的压降和亮度差。

\* Normally, we recommend brightness drop within 30%, so the recommend connecting length is 4m.

一般情况下,我们建议首位亮度差维持在30%以内, 所以该产品推荐的连接长度为4米。

## Temp. Curve(温度曲线)

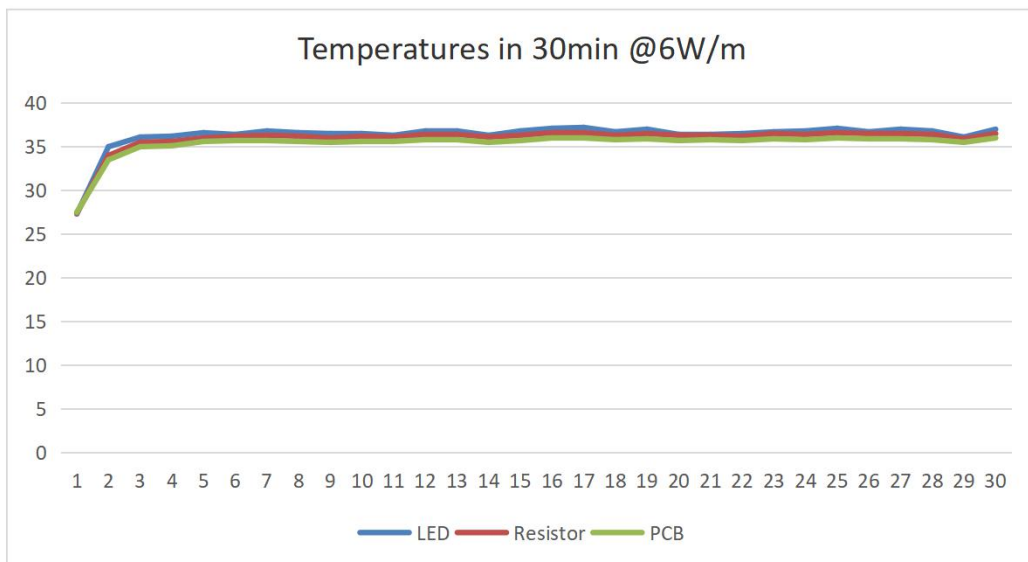

\* The above curve indicates the change of temperature after powering on 30 minutes.





\* 以上的温升图基于通电后30分钟的测试数据。

\* The y-axis indicates the changes of temperatures on LED surface, PCB, and Resistor at TC25°C.

\* Y轴表示焊盘, 灯珠表面, PCB, 以及电阻在室温25°C下的温度变化。

## Waterproof Ways(防水方式)

Available waterproof ways:

Waterproof Ways	IP Rating	Details
防水方式	防水等级	细节说明
	IP54	PU or Silicone glue on the surface of the led strips. 表面滴PU或者硅胶
	IP65	Heat Shrink tube or Silicone tube for led strips. 热缩套管或者硅胶套管防水
	IP67	Hollow integrated silicone glue. 挤出型硅胶防水, 中空
	IP68	Solid Integrated Silicone glue, or silicone glue with silicone tube 挤出型一体化硅胶防水, 实心; 或者灌胶(硅胶套管里加硅胶)

## Installation Ways(安装方式)

Install the LED strip within the Max Length which specified in the specification, for installing more than Max Length, please connect them in parallel.

根据规格书上声明的最大长度去安装, 如果安装长度超过最大长度, 请采用并联的方式.

Usually most of the power supply has a efficiency between 80%-95%, so when choosing the power supply, the total watts of the strips should be smaller than 80% of the rate power of the Power Supply.

通常大部分电源的输出效率大概在80%-95%, 所以当选择电源时, 应注意灯带的输出功率必须小于电源额定功率的80%.

Only powered by 24Vdc, do not use other power source to power the LED strip.

只接受24Vdc供电, 不能使用其他类型的电源供电.

### Wiring Diagram(接线图)

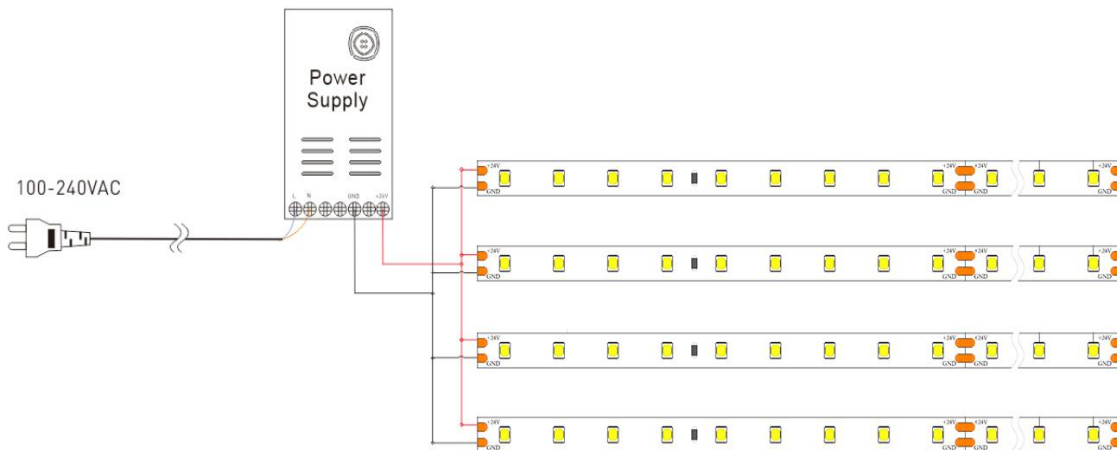

## Applications(应用)

\* Used in linear lights as lighting source; used for indoor decorations.  
作为线条灯条光源，用作室内室外的照明。

## Package(包装)

①) 5 meters per roll.

5m一卷。

②) Each roll packed with anti-static bags, and label on it.

每一卷放入静电袋中，静电袋表面贴标签。

③) 25 rolls into a small box.

25卷放入一个小箱子中。

④-⑤) 2 small boxes into a large carton 520\*320\*300mm.

2个小箱放入一个大箱。

⑥) Delivery.

发货。

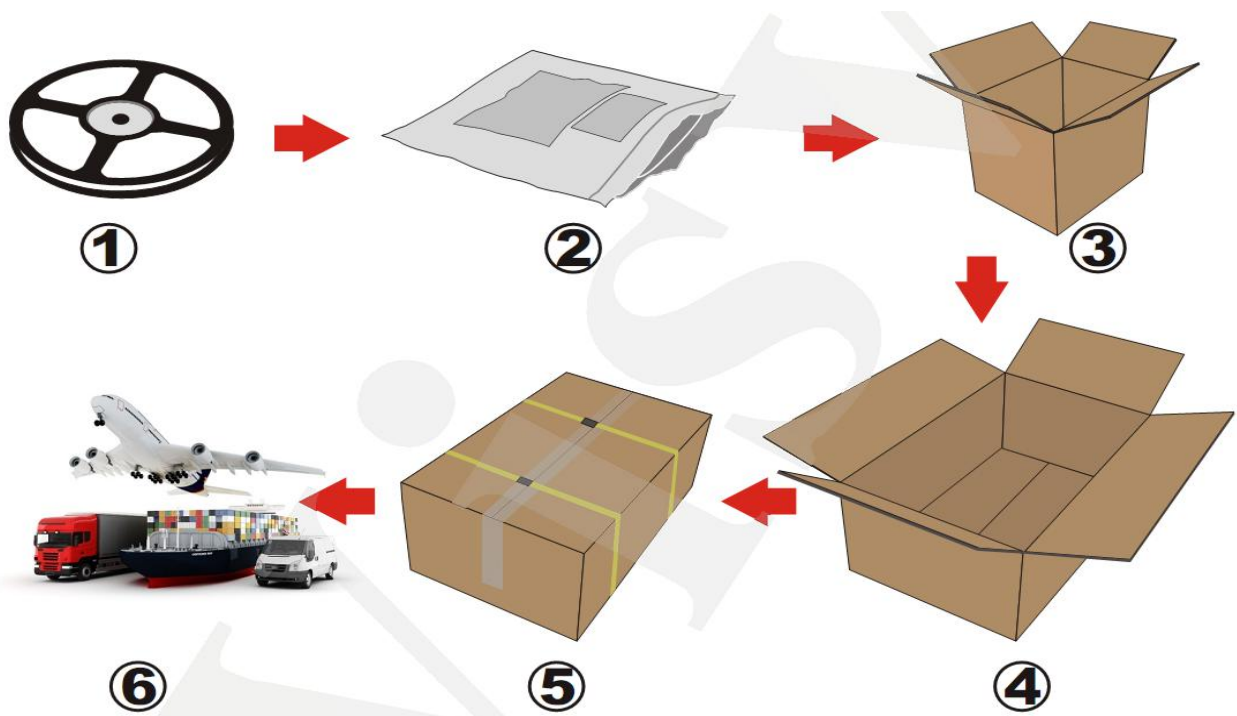

## X-ON Electronics

Largest Supplier of Electrical and Electronic Components

*Click to view similar products for [LED Lighting Bars and Strips](#) category:*

*Click to view products by [WISVA OPTOELECTRONICS](#) manufacturer:*

Other Similar products are found below :

[ZLF0310W62524](#) [LF1D-F2F-2W-300](#) [LF2D-EN2F-2W-A](#) [N006120BC1LZ \(GOLDEN YELLOW\)](#) [RF-GW2H39W19-2406020I1-A1 IP20](#)  
[2633830000](#) [HH-SX72F008W24-2835 CW WHITE PCB IP20](#) [HH-SX180F010W24 -2835 WW WHITE PCB IP20](#) [HH-SX72F008W24-2835](#)  
[NW WHITE PCB IP20](#) [HH-SX144F008W24 -2835 NW WHITE PCB IP20](#) [HH-SX180F010W24 -2835 NW WHITE PCB IP20](#) [HH-](#)  
[SX144F008W24 -2835 CW WHITE PCB IP20](#) [HH-SX144F008W24 -2835 WW WHITE PCB IP20](#) [HH-SX180F010W24 -2835 CW WHITE](#)  
[PCB IP20](#) [N008120BB1LZ \(BLUE\)](#) [00219015](#) [10001611](#) [10001612](#) [10001613](#) [10001617](#) [10001618](#) [10001619](#) [10001622](#) [10001623](#)  
[10001655](#) [10001657](#) [10001664](#) [10001670](#) [10001675](#) [10001681](#) [10001683](#) [10001690](#) [PUUA-100LLL-NK2P](#) [QAUR1161L030](#) [HC-F12V-](#)  
[3535 PCBA](#) [HC-F12V-F50-3L-WS2811](#) [HC-F12V-WS2811-3535](#) [HC-F5V-144L-144LED-B-WS2813 IP20](#) [HC-F5V-144L-144LED-B-](#)  
[WS2813 IP65](#) [HC-F5V-144L-144LED-W-WS2813 IP20](#) [HC-F5V-30L-30LED-B-WS2813 IP20](#) [HC-F5V-30L-30LED-W-WS2813 IP20](#) [HC-](#)  
[F5V-60L-60LED-B-WS2813 IP20](#) [HC-F5V-60L-60LED-W-WS2813 IP65](#) [HC-T12V-10L-30LED-W/IP20](#) [HC-T12V-16L-48LED-W/IP20](#)  
[HC-T12V-16L-48LED-W/IP65](#) [HC-T12V-20L-60LED-W/IP65](#) [LFBLL-SW860-24V-5S200-20-IC](#) [LFBML-MW827860-24V-12D83-20](#)