

wolcraft®

Main catalogue



Innovative Tools Universal accessories



wolcraft GmbH
Wolffstraße 1
D-56746 Kempenich

Service Hotline: 00 49 (0) 2655 51 280
Fax: 00 49 (0) 26 55 50 21 80
E-mail: customerservice@wolcraft.com

Technischer Support
Fax: 00 49 (0) 2655 50 20 80
E-mail: technical.Service@wolcraft.com

www.wolcraft.com



GB 9999376 / 1300 / 01.19



Main catalogue

Innovative Tools Universal accessories

Effective January 2nd 2019

Legend

TIN	= Titanium nitride, compound of evaporated titanium and nitrogen
HSS-Co	= High-speed steel with a high cobalt percentage (more than 5 %)
HSS	= High Speed Steel
HM	= Tungsten carbide tipped
WS	= Tool steel
CV	= Chromium Vanadium
BiM	= BiMetal, flexible and hard
HCS	= High Carbon Steel
HAS	= High Alloy Steel

 = 10 year guarantee

We provide a warranty of 10 years from the day of purchase on the wolcraft product you acquired, provided it is exclusively used for DIY purposes.
The warranty only covers damage to the item purchased, and only such damage that can be attributed to faulty material and poor workmanship.
The warranty does not cover defects and damage that must be attributed to improper use or insufficient maintenance. Nor does the warranty cover the usual wear and tear as well as defects and damage, of which the customer has been aware when purchasing the equipment.

Warranty claims can only be asserted by producing the invoice or the till receipt.

The warranty granted by wolcraft does not in any way restrict your statutory consumer rights (i.e. contract performance, withdrawal from the contract, price reduction, claims for damages or reimbursement of expenses).

Individual articles may be subject to technical changes.

Dimensions, colours as well as product images and descriptions may deviate from the original.
The content of the catalogue is subject to the above conditions.

ILN 4006885000001

VAT Number DE 147924531

Manufacturing expertise since 1949 – family-owned company rich in tradition and experience

For 70 years, wolcraft GmbH has been successfully established as a German-European manufacturer and supplier of hand tools and power tool accessories. The success story of our owner-operated family business began with its establishment in 1949 by Robert Wolff. Since then, the wolcraft brand has been synonymous with quality driven by manufacturing expertise.

With 600 employees, a strong development department and a total of 10,500 square metres of production space in Weibern and Malé Dvorníky, we generate most of our value added in-house. We can thus offer both the retailers and the end user high-quality, controlled production from a single source.

The user's point of view has traditionally been pivotal to our product development and therefore a driver of both success and innovation. When it comes to developing retail concepts, we are guided in equal measure by the requirements of the end user and the objectives of the retailers.

Strong focus on service – needs-based assortment design with high profitability per unit area

To increase sales opportunities and ensure optimal profitability per unit area, we support our retail partners with professional, software-assisted category management. We optimise your sales with individually combinable assortment modules. We ensure customer-specific assortment planning and fitting out through our own merchandisers within the sales organisation, and also insist on the regular exchange of information and feedback discussions with retailers. This results in valuable insights that always help to further improve the service and the sales successes at a high level.

Europa-wide customer service and sales representatives

With five subsidiaries, wolcraft is represented in 36 countries worldwide.

In Germany and Europe, DIY stores and specialist retailers receive personal attention from our competent sales to ensure effective support.

And we also attach great importance to service in the after sales area. After buying our products, every end user can rely on professional support to provide assistance in the event of questions or problems. Our Customer Service Team can provide advice in many different languages. If necessary, issues can be escalated to the Technical Customer Service – this is how we develop solutions quickly and relieve the pressure on the retailers.



Index Product groups

Productgroup	Page	Productgroup	Page
1 Machine tables		03 Bits/ Handscrewdrivers/ Holders/ Adapters	153
01 Roller stands / Workstands	6	04 Abrasives	177
04 Machine tables	8	05 Brushes	235
06 Guiding systems	12	06 Saw blades	251
96 Accessories	14	07 Rasps / Countersinks	263
2 Clamping tables and Workbenches		08 Drill chucks	275
01 Clamping tables	18	09 Router bits	280
03 Workshop System	23	10 Mixers	288
3 Transport systems		11 Attachments	292
01 Hand Trucks	45	12 Drills / Chisels	302
03 Removal helpers	51	13 Stapler / Staples	333
4 Clamping tools		14 Cutting/ roughing discs	342
01 One-hand clamps	57	15 Health and safety	354
03 Screw clamps	60	16 Accessories for vibration saws	368
04 Spring clamps plastic	62	7 Hand tools	
05 Ratchet clamps	66	01 Cutting tools	390
06 Belt clamps	68	02 Measuring tools	412
07 Frame clamps	70	8 Project themes	
08 Hook and loop strips	72	01 Laying laminate and vinyl	417
09 Tensioning rubber bands	73	02 Processing plasterboards	427
10 Corner clamps	74	03 Firewood	441
11 Special clamping tools	75	04 Processing elastic sealants	446
5 Wood joints		05 Wooden deck construction	456
01 Dowel connections	77	06 Laying tiles	463
03 Biscuit joints	82	07 Door and door frame fitting	470
04 Screw joints	84		
05 Wooden parts	85		
98 Miscellaneous	86		
6 Power Tool Accessories			
01 Jigsaw blades	87		
02 Hole saws / Annular bits	125		

MACHINE TABLES 1



1 MACHINE TABLES

1.1 Roller stands / Workstands

The wolcraft support trestle is the ideal aid for any interior work!

1 workstand - work support



foldable supports for fixing long parts, ideal for cutting jobs or as storage



- 3 adjustable soft clamps to protect the workpiece
- adjustable stops on the side prevent the workpiece from slipping away
- foldable supports for fixing long parts, ideal for cutting jobs or as storage
- can be folded for space-saving storage
- version: completely assembled
- working height 735 mm
- resting width: 620 mm
- packaging: sleeve

article no.	EAN	description	max. loading	weight
6905000	4006885... ...690509	1 workstand - work support	100 kg	3.385 kg

MACHINE TABLES

1

1.1 Roller stands / Workstands



the stable support is used for extending the bearing surface of a work table and for supporting long work pieces



the ball support allows the work piece to be fed in easily and moved in all directions, e.g. for milling

- can be used with all standard machine tables and workbenches
- for putting down and rolling off long boards, planks and slabs
- with a continuous height adjustment
- the stable support is used for extending the bearing surface of a work table and for supporting long work pieces
- the bearing-mounted supporting roller allows the materials to be fed easily in the processing direction
- the ball support allows the work piece to be fed in easily and moved in all directions, e.g. for milling
- can be folded for space-saving storage
- resting width: 300 mm
- packaging: sleeve
- complementary products: 6177000, 6182000, 6902000, 6902506, 6902612, 6906000, 6906506, 6906612, 6908000



article no.	EAN	description	working height	max. loading	weight
6102300	4006885... ...610231	1 multi-function support stand & roller trestle	630 - 1,000 mm	50 kg	5.6 kg



the bearing-mounted supporting roller allows the materials to be fed easily in the processing direction



The practical extension for sawing tables and workbenches

- can be used with all standard machine tables and workbenches
- with a continuous height adjustment
- the bearing-mounted supporting roller allows the materials to be fed easily in the processing direction
- can be folded for space-saving storage
- version: completely assembled, welded
- resting width: 300 mm
- packaging: sleeve
- complementary products: 6177000, 6182000, 6902000, 6902506, 6902612, 6906000, 6906506, 6906612, 6908000

article no.	EAN	description	working height	max. loading	weight
6119973	4006885... ...611993	1 roller trestle	640 - 1,000 mm	60 kg	3.9 kg

1 MACHINE TABLES

1.4 Machine tables

MASTER cut 2500

Saw table and work station for all trades involved in interior works

6-in-1: one saw table - six functions

Since it can be used as a work station, circular saw bench, guided circular saw bench, milling table, jigsaw table and mitre saw table, the MASTER cut 2500 is a 6-in-1 machine table designed for all trades involved in interior works.

Product benefits:

- multifunctional for all projects, especially suitable for interior works
- extraction system for dust-free working
- stable and safe thanks to cross struts and height-adjustable legs
- mobile and space-saving thanks to quick-folding system
- compatible with virtually all circular hand saws, jigsaws, routers, mitre saws
- suitable for circular hand saws with and without a riving knife
- in accordance with DIN EN 62841

Scope of delivery:

- table with MDF worktop, foldable legs, machine plate, safety shield
- switch clamp, push stick
- safety switch
- 4 plastic clamping jaws
- 3 split inserts for circular saw bench, guided circular saw and router/jigsaw
- guide rail
- 2 insert rings (15 and 25 mm) for routers
- angle stop, parallel stop
- angle stop for guide rail



Technical data:

- use of circular hand saws:
- with riving knife, up to a maximum cutting depth of 70 mm, saw blade diameter of 200 mm and the specified maximum base plate dimensions (see pictogram); must only be used with appropriate split insert!
- machines without riving knife can only be used in combination with riving knife art. no. 6916000 (up to max. 160 mm saw blade diameter) or riving knife art. no. 6917000 (from 161 up to max. 200 mm saw blade diameter)!
- for routers with max. 230 V, max. 1800 W, maximum base plate diameter: 170 mm; maximum base plate height: 20 mm; for maximum router diameters of 27 mm; must only be used with parallel milling guide (art. 6901000)!
- dimensions when fully assembled w = 1185, d = 757, h = 863 mm
- dimensions when folded: w = 1085, d = 757, h = 213 mm
- worktop dimensions: w = 1035, d = 695 mm
- working height: 863 mm
- diameter of clamping holes: 20 mm
- max. workpiece height: circular saw bench 60 mm, guide rail 60 mm
- max. cutting width with parallel stop: circular saw bench 570 mm
- max. cutting length: guide rail 740 mm
- maximum load: up to 120 kg
- weight 24 kg

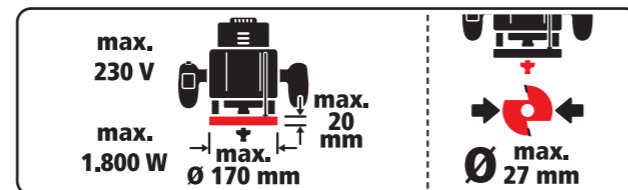
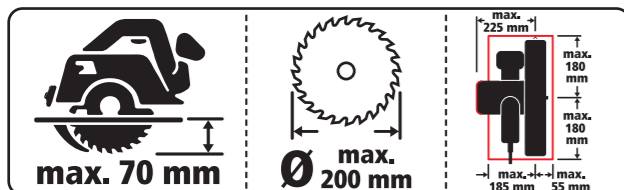
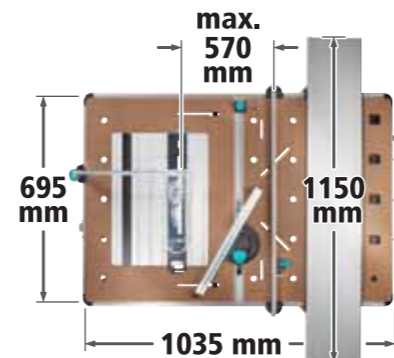

6-in-1: one saw table - six functions



Circular saw bench function

- ideal for smaller workpieces that can be pushed over the table
- precise parallel cuts up to a cutting width of 570 mm and a cutting length of 740 mm
- precise angular cuts from 0 - 180° using the angle stop
- circular hand saws without integrated riving knife can be used thanks to the optionally available wolcraft riving knife



Guided circular saw function

- with wolcraft guide rail & clamping jaws
- ideal for sawing big panels and boards thanks to the 80 cm long aluminium rail
- stop slide for precise repetitive cuts can be set to any angle between 0 - 70°
- the aluminium machine plate enables a change from circular saw bench to guided sawing with the guide rail in seconds



Jigsaw table function

- ideal for curved cuts
- unobstructed view at the marked line
- easy guidance of the work piece by hand



Mitre saw table function

- also compatible with all mitre saws thanks to the multifunctional hole pattern in the table plate



Milling table function

- accessories: parallel milling guide (art. no. 6901000), turns the MASTER cut 2500 into a real milling table
- height-adjustable machine plate for smooth transitions
- warning: use of the milling table is only allowed in combination with the parallel milling guide!



Mobile work station function

- the big work surface made of impact resistant MDF comes up with many clamping possibilities
- quick assembly of static devices such as drill stands, etc. using fastening slots in the MDF plate
- robust and stable thanks to a sturdy base frame and a height-adjustable foot
- versatile use and space-saving storage
- easy transport thanks to the light aluminium construction

Article no.	EAN-Code 4006885...	Description	for
6902000	...690202	1 MASTER cut 2500 - saw table and work station	EU ex. GB, IRL, DK
6902506	...690257	1 MASTER cut 2500 - saw table and work station	GB, IRL
6902612	...690264	1 MASTER cut 2500 - saw table and work station	CH

1 MACHINE TABLES

1.4 Machine tables

MASTER cut 1500

Universal work and machine table in accordance with the latest EU safety regulations.
For stationary use of circular saws, jigsaws and routers.

Advantages:

- multifunctional for all projects
- can be used as a circular saw bench, jigsaw table, milling table in conjunction with milling guide No. 6901000 and work station
- adjustable aluminium machine plate and easy machine mounting
- supporting frame with crossmembers for max. stability, mobile and space-saving thanks to quick folding system
- robust beechwood vice
- compatible with virtually all hand mounting of all commercially available circular hand saws, routers and jigsaws

Including:

- 1 angle stop
- 1 parallel stop
- 1 safety switch
- 1 push stick
- 1 switch clamp
- 1 safety shield
- 4 plastic jaws for securing the workpiece horizontally
- 2 insert rings 15 and 25 mm for routers



The mark of responsible forestry
FSC® C008243

Technical data:

- working height: 865 mm
- max. span / with clamping jaws: 120 - 620 mm
- size of bench top: 780 x 500 mm
- MDF plate: 495 x 500 x 23 mm
- machine plate: 285 x 500 mm
- worktops made from MDF and die-cast aluminium
- dimensions mounted: 940 x 640 x 865 mm
- dimensions folded: 640 x 1145 x 195 mm
- weight: 17 kg
- max. loading: 200 kg

for circular

hand saws: with riving knife, up to a maximum cutting depth of 70 mm, saw blade diameter: 200 mm; machine plate dimensions: see pictogram (no cordless circular hand saws)

Instructions: By using riving knife accessory Art. No. 6903000 (up to 160 mm) or Art. No. 6904000 (160 - 200 mm), circular hand saws can also be used without a riving knife.

for jigsaws: all

for routers: with max. 230 V, max. 1800 W, maximum machine plate diameter: 170 mm; maximum machine plate height: 20 mm; for maximum router diameters of 27 mm

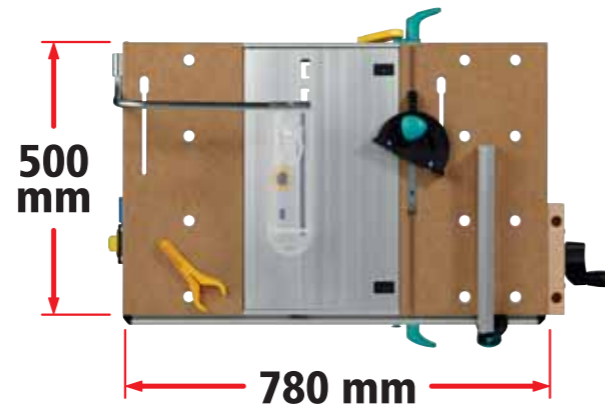

MACHINE TABLES

1

4 in 1: circular saw bench, sawing table, milling table and workbench

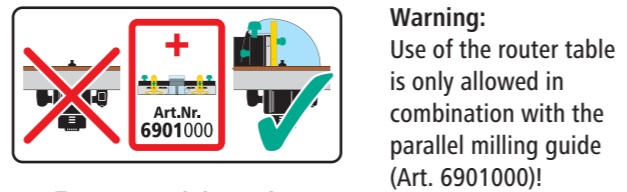
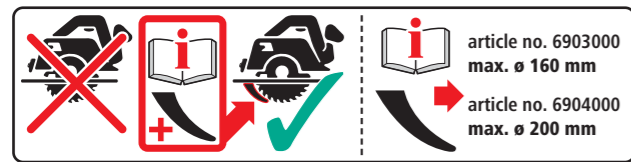
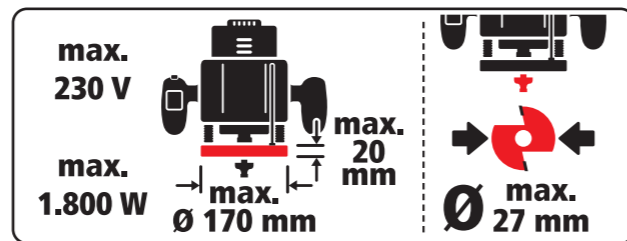
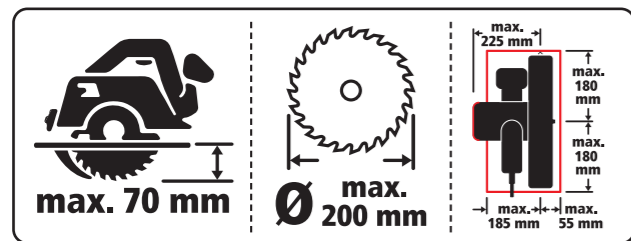

article no.	EAN-Code 4006885...	description	for
6906000	...690608	1 MASTER cut 1500 - Work and machine table	EU ex. GB, IRL, DK
6906506	...690653	1 MASTER cut 1500 - Work and machine table	GB, IRL
6906612	...690660	1 MASTER cut 1500 - Work and machine table	CH

1 MACHINE TABLES

1.4 Machine tables



parallel cuts



curved cuts

The ideal accessory for precision jigsaw work

Exact cutting thanks to a clear line of sight on the marked line and parallel stop.

Less ragged edges with clean cut edges on the topside of the workpiece, due to simpler cutting from the underside of the material.

- two steel clamps for secure fastening to any work table with a thickness of max. 60 mm
- bench top 320 x 300 mm
- work top: galvanised
- for jigsaws: max. length of saw blade 100 mm
- including: 1 parallel stop
- packaging: covering box



article no.	EAN	description	product dimensions
6197000	4006885... ...619708	1 jigsaw table	320 x 300 mm

1.6 Guiding systems

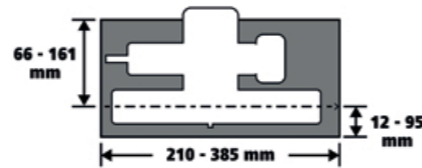

Guide system for circular hand saws



- machine: for commercial circular hand saws with a 40-70 mm cutting depth, saw blade diameters of 130-200 mm, and the minimum/maximum dimensions of the base plate specified in the drawing
- easy installation and precise cutting guidance for longitudinal and diagonal cuts
- the rubber lip reduces skips and marks the cutting edge for precise results
- 2-piece rail for fast and convenient installation
- slip-resistant underside for safe positioning
- high-quality aluminium design provides durability
- with a cutting length of up to 1100 mm ideal for shortening door leaves, etc.
- packaging: covering box
- separate accessories: 6914000

article no.	EAN	description	product dimensions
6913000	4006885... ...691308	1 FKS 145 - guide rail	1,450 x 242 x 50 mm

MACHINE TABLES 1

1.6 Guiding systems



- simple and fast extension of the FKS 145 guide rail for processing large workpieces
- extends the guide to 2,550 mm, with a maximum cutting length of 2,200 mm
- also repeatedly extendible
- 2 rail connectors for fast mounting
- high-quality aluminium design provides durability
- packaging: covering box
- suitable for 6913000

article no.	EAN	description	product dimensions
6914000	4006885... ...691407	1 extension set for FKS 145	1,100 x 190 x 10 mm



Universal and precise – the wolcraft FKS 115 guide rail is the ideal accessory for circular saws



- machine: all commercially available circular saws up to a cutting depth of 66 mm and with a maximum base plate of 120-200 x 260-385 mm
- for precise, straight and long cuts
- for cutting or shortening kitchen worktops, doors etc.
- the rubber lip reduces the risk of getting skips, marks the cutting edge at the same time and thereby ensures precise cuts
- fast and comfortable assembly of the circular saw, needs adjusting once only
- the skid-proof bottom and 2 clamps supplied will safely position the tool
- the workpiece is protected against scratches by the base plate of the circular hand saw since the machine does not rest directly on the workpiece
- including: 2 clamps
- packaging: paperboard card
- separate accessories: 6911000

article no.	EAN	description	product dimensions
6910000	4006885... ...691001	1 FKS 115 - guide rail	1,150 x 242 x 50 mm

1 MACHINE TABLES

1.6 Guiding systems



- allows the accurate processing of large work pieces
- simple and fast extension of FKS 115
- length of the guiding mechanism: 230 cm
- extension also with more than 2 rails possible
- only usable together with article No. 6910000!
- content:
 - 1 aluminium rail
 - 1 extension adaptor
- packaging: covering box
- suitable for 6910000

article no.	EAN	description	product dimensions
6911000	4006885... ...691100	1 extension set	1,150 x 220 x 10 mm

1.96 Accessories



- for stationary use of power drills
- Euronorm collar ø 43 mm
- packaging: fixed on card
- suitable for 6906000, 6906506, 6906612

article no.	EAN	description
6152000	4006885... ...615205	1 drill clamp

MACHINE TABLES 1

1.96 Accessories

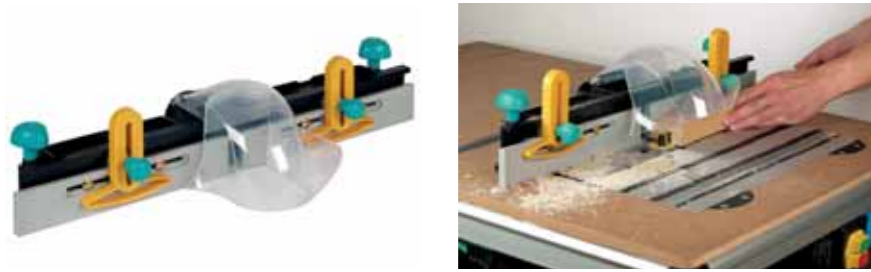

The parallel milling guide turns the MASTER cut into a real router table.

- for workpieces up to 40 mm thickness
- for routers up to 27 mm diameter
- only usable together with article No. 6900000, 6906000!
- precisely adjustable guide for perfect results
- adjustable guide to be adapted to the router size
- safe locking of the parallel milling guide through turning knobs and without tools
- connection for dust extraction
- tip: larger work pieces should be supported by a roller stand (e.g. Art. No. 6102300)
- packaging: covering box
- weight: 2.8 kg
- suitable for 6902000, 6902506, 6902612, 6906000, 6906506, 6906612

article no.	EAN	description
6901000	4006885... ...690103	1 parallel milling guide



6903000



6904000



- for the use of circular hand saws without a riving knife on the MASTER cut 1500
- packaging: plastic bag on card
- suitable for 6906000, 6906506, 6906612

article no.	EAN	description	for
6903000	4006885... ...690301	1 riving knife	for circular saw blades up to max. Ø 160 mm
6904000	...690400	1 riving knife	for circular saw blades Ø 161 - 200 mm

1 MACHINE TABLES

1.96 Accessories



- for the use of circular hand saws without a riving knife on the MASTER cut 2500
- packaging: plastic bag on card
- suitable for 6902000, 6902506, 6902612



article no.	EAN	description	for
6916000	...691605	1 riving knife	for circular saw blades up to max. Ø 160 mm
6917000	...691704	1 riving knife	for circular saw blades Ø 161 - 200 mm



2.1 Clamping tables

1 MASTER 700 - clamping and machine table



Unsurpassed versatility coupled with a modern design characterise this height-adjustable clamping and machine table.

- table plate made from 19 mm MDF continuously tiltable from 0° - 70°
- quick and easy assembly of stationary devices such as mitre



- saws and drill stands using fastening slots in the MDF plates
- the new, sturdy and stable Z-design of the base frame facilitates ergonomic working when either standing or seated
- integrated compression spring simplifies height adjustment
- quick folding system for space-saving storage; feet can be simply folded up via the pull rod
- including 4 clamping jaws for securing round and horizontal workpieces
- including 2 protection jaws for long, round objects, such as pipes, etc.
- with 4 handy rest pins - both ends usable with pointed rest for painting jobs or flat anti-skid rests
- packaging: covering box
- complementary products: 6102300, 6119973
- separate accessories: 3036000, 6171000, 6172000, 6174000, 6176000

Technical data

working height:	780 - 950 mm
max. span / with clamping jaws:	130 / 435 mm
bench top:	680 x 390 mm
max. loading:	150 kg
clamping system:	handles, spindle adjustment clamping jaws
work top:	MDF, tiltable 0 - 70°
base frame:	robust quick-folding system, integrated tool rack
dimensions mounted:	680 x 780 - 950 x 525 mm
dimensions folded:	680 x 960 x 185 mm
weight:	14.5 kg

article no.	EAN	description
6908000	4006885... ...690806	1 MASTER 700 - clamping and machine table

CLAMPING TABLES AND WORKBENCHES 2

2.1 Clamping tables

Height-adjustable clamping and working table

1 MASTER 600 - clamping and working table



can be folded for space-saving storage



tabletop infinitely tiltable between 0 - 65° provides new areas of use



plastic jaws for securing the workpiece horizontally

The right working height for all uses! The height adjustment provides you with an ergonomic working position for all heights no matter whether seated or standing.

- heightadjustment with lockable extension
- larger table area due to use of an extension plate
- tabletop infinitely tilt-able between 0 - 65° provides new areas of use
- magnet in the MDF board for storing screws and nails
- robust base frame which can be quickly folded away for space-saving storage
- packaging: covering box
- complementary products: 6102300, 6119973
- separate accessories: 3036000, 6171000, 6172000, 6174000, 6176000



Technical data

working height:	780 - 950 mm
max. span / with clamping jaws:	115 / 435 mm
bench top:	650 x 420 mm
max. loading:	120 kg
max. clamping angle:	10°
clamping system:	handles, spindle adjustment clamping jaws
adjustment aid:	scale
work top:	MDF, tiltable 0 - 65°
base frame:	robust quick-folding system, integrated tool rack
including:	4 plastic jaws for securing the workpiece horizontally 2 additional jaws for clamping round workpieces 1 extension plate
dimensions mounted:	650 x 780 - 955 x 420 - 530 mm
dimensions folded:	650 x 1,065 x 210 mm
weight:	15.1 kg

article no.	EAN	description
6182000	4006885... ...618206	1 MASTER 600 - clamping and working table

CLAMPING TABLES AND WORKBENCHES

2.1 Clamping tables

Universal clamping and working table

1 MASTER 200 - clamping and working table



can be folded for space-saving storage



Robust universally useful clamping and working table; no workshop or household should be without one.

- 2 MDF jaws, the front jaw is adjusted using 2 handles
- robust base frame which can be quickly folded away for space-saving storage
- integrated tool rack
- packaging: covering box
- complementary products: 6102300, 6119973
- separate accessories: 3036000, 6171000, 6172000, 6174000, 6176000

Technical data

working height:	800 mm
max. span / with clamping jaws:	145 / 365 mm
bench top:	645 x 300 mm
max. loading:	180 kg
max. clamping angle:	14°
clamping system:	handles, spindle adjustment clamping jaws
adjustment aid:	scale
work top:	MDF
base frame:	robust quick-folding system, integrated tool rack
including:	4 plastic jaws for securing the workpiece horizontally
dimensions mounted:	645 x 800 x 300 - 450 mm
dimensions folded:	645 x 1,205 x 200 mm
weight:	11.9 kg

article no.	EAN	description
6177000	4006885... ...617704	1 MASTER 200 - clamping and working table

CLAMPING TABLES AND WORKBENCHES 2

2.1 Clamping tables

Accessories



- protect the workpiece against damages
- with V groove for clamping round material
- packaging: plastic bag on card
- suitable for 6177000, 6182000, 6906000, 6906506, 6906612, 6908000



article no.	EAN	description
6171000	4006885... ...617100	2 vice jaws



- for all worktops with 20 mm bore
- plastic jaws for securing the workpiece horizontally
- packaging: plastic bag on card
- suitable for 6177000, 6182000, 6902000, 6902506, 6902612, 6906000, 6906506, 6906612, 6908000



article no.	EAN	description
6172000	4006885... ...617209	4 clamping jaws



- packaging: plastic bag on card
- suitable for 6177000, 6182000, 6902000, 6902506, 6902612, 6906000, 6906506, 6906612, 6908000



article no.	EAN	description
6174000	4006885... ...617407	4 plastic vice jaws

2 CLAMPING TABLES AND WORKBENCHES

2.1 Clamping tables



- for all worktops with 20 mm bore
- packaging: plastic bag on card
- suitable for 6177000, 6182000, 6902000, 6902506, 6902612, 6906000, 6906506, 6906612, 6908000



article no.	EAN	description
6176000	4006885... ...617605	2 quick clamps

CLAMPING TABLES AND WORKBENCHES 2
2.3 Workshop System



2.3 A Workshop Just the Way You Want It

"Do you finally want to get your workshop straightened out? Do you want a workshop area where you feel comfortable? And on top of that, do you want a workshop in which you can work ergonomically and practically? The wolcraft workshop offers all of the above!"



Product advantages:

STABILITY

- 30 mm thick beech worktop
- 2 mm thick steel elements
- 600 kg load capacity
- Solid plastic
- Wall attachment set
- Smooth running drawers suitable for 25 kg of load

ORDER

- Cabinet drawers with up to 3 shelves
- Different drawer sizes
- Drawers can be sub-divided
- Drawer removal system

INDIVIDUALITY

- More than 100 individual combinations possible
- Can be expanded at any time
- Free selection of feet



TRANSPORT & SELF ASSEMBLY

- Quick change system for stationary devices
- Easy transport, no bulky package, few screws
- Quick assembly system through pre-assembled nuts



The Order System

Standard drawers
For e.g. drill boxes and screws



Low drawers
For e.g. spanners



Quick Change System
A flat work surface and an integrated bench vice or drill stand are not mutually exclusive!

- **Secure and stable attachment of stationary devices** such as e.g. bench vice or drill stand
- **Can be removed quickly** thanks to the quick change system for maximum work space

High drawers
For correct storage of machines



Cabinet drawers
For up to three flexibly selectable shelf inserts



2 CLAMPING TABLES AND WORKBENCHES

2.3 Workshop System

Workbench components



- material: beech
- packaging: covering box



article no.	EAN	description	product dimensions
6043000	...604308	1 workplate beech S	650 x 650 x 30 mm



- material: beech
- packaging: covering box



article no.	EAN	description	product dimensions
6044000	...604407	1 workplate beech M	1,130 x 650 x 30 mm



- material: beech
- packaging: covering box



article no.	EAN	description	product dimensions
6045000	...604506	1 workplate beech L	1,610 x 650 x 30 mm

CLAMPING TABLES AND WORKBENCHES

2.3 Workshop System

2



- content:
2 pairs of legs, made from strong 40 x 40 mm square tube
3 standard feet, insertable
1 foot height adjustable
1 set of angle brackets
- packaging: sleeve



article no.	EAN	description
6782000	4006885... ...678200	1 set of legs



- for workbench - table width 650 mm
- content: 4 struts S
- packaging: shrinkwrapped with inlay



article no.	EAN	description
6785000	4006885... ...678507	1 connector set S



- for workbench - table width 1130 mm
- content:
4 struts M
2 centre struts, small
2 centre struts, large
- packaging: shrinkwrapped with inlay



article no.	EAN	description
6786000	4006885... ...678606	1 connector set M



- for workbench - table width 1610 mm
- content:
4 struts L
4 centre struts, small
4 centre struts, large
- packaging: shrinkwrapped with inlay



article no.	EAN	description
6787000	4006885... ...678705	1 connector set L

2 CLAMPING TABLES AND WORKBENCHES

2.3 Workshop System



- working height 86 cm: 4 feet
- working height 93 cm: 8 feet
- working height 100 cm: 12 feet
- individual choice of workbench height through insertable feet
- packaging: bulk



article no.	EAN	description
6067000	4006885... ...606708	1 standard foot pluggable



- height-adjustable for compensating floor irregularities up to 40 mm
- packaging: with hang tag



article no.	EAN	description
6068000	4006885... ...606807	1 foot height adjustable



- for a mobile workbench
- version: with brake, steerable
- packaging: with hang tag

article no.	EAN	description
6066000	4006885... ...606609	1 foot with caster and brake, steerable



- version: smooth-glide drawers, with quick-removal system
- material: made of highly impact resistant plastic
- max. loading 25 kg
- including:
 - 4 drawer guides
 - 2 aluminium faceplates with labelling field
- packaging: covering box
- separate accessories: 6071000

article no.	EAN	description	height
6779000	4006885... ...677906	2 drawers S	70 mm

CLAMPING TABLES AND WORKBENCHES 2

2.3 Workshop System



- for S drawers, Art. No. 6779000
- packaging: shrinkwrapped with inlay
- suitable for 6779000

article no.	EAN	description
6071000	4006885... ...607101	2 drawer dividers small



- version: smooth-glide drawers, with quick-removal system
- material: made of highly impact resistant plastic with floor plate
- max. loading 25 kg
- including:
 - 2 drawer guides
 - 1 aluminium faceplate with labelling field
- packaging: covering box
- separate accessories: 6072000

article no.	EAN	description	height
6780000	4006885... ...678002	1 drawer M	140 mm



- for M drawers, Art. No. 6780000
- packaging: shrinkwrapped with inlay
- suitable for 6780000

article no.	EAN	description
6072000	4006885... ...607200	2 drawer dividers big



- version: smooth-glide drawers, with quick-removal system
- material: made of highly impact resistant plastic with floor plate
- max. loading 25 kg
- including:
 - 2 drawer guides
 - 1 aluminium faceplate with labelling field
- packaging: covering box

article no.	EAN	description	height
6781000	4006885... ...678101	1 drawer L	280 mm

2 CLAMPING TABLES AND WORKBENCHES

2.3 Workshop System



- for S and M workshop systems drawers
- keep drawers tidy with everything in its place
- smart and simple storage system
- simple replacement of the boxes and a secure grip on the nubbed mat
- material: plastic material
- content:
 - 3 storage boxes, 120 x 90 x 50 mm
 - 3 storage boxes, 120 x 120 x 50 mm
 - 3 storage boxes, 240 x 90 x 50 mm
 - 1 nubbed mat, 390 x 375 mm
- packaging: covering box



article no.	EAN	description
6790000	4006885... ...679009	1 DSP 10 WSS - drawer organiser system



- for S and M workshop systems drawers
- keep drawers tidy with everything in its place
- smart and simple storage system
- simple replacement of the boxes and a secure grip on the nubbed mat
- material: plastic material
- content:
 - 5 storage boxes, 60 x 60 x 50 mm
 - 3 storage boxes, 90 x 60 x 50 mm
 - 1 storage box, 120 x 60 x 50 mm
 - 1 storage box, 90 x 90 x 50 mm
 - 2 storage boxes, 120 x 90 x 50 mm
 - 1 storage box, 180 x 90 x 50 mm
 - 3 storage boxes, 240 x 90 x 50 mm
 - 1 nubbed mat, 390 x 375 mm
- packaging: covering box



article no.	EAN	description
6791000	4006885... ...679108	1 DSP 17 WSS - drawer organiser system

CLAMPING TABLES AND WORKBENCHES 2

2.3 Workshop System



- for S and M workshop systems drawers
- keep drawers tidy with everything in its place
- smart and simple storage system
- simple replacement of the boxes and a secure grip on the nubbed mat
- material: plastic material
- content:
 - 5 storage boxes, 60 x 60 x 50 mm
 - 10 storage boxes, 90 x 60 x 50 mm
 - 10 storage boxes, 120 x 60 x 50 mm
 - 1 storage box, 90 x 90 x 50 mm
 - 1 nubbed mat, 390 x 375 mm
- packaging: covering box



article no.	EAN	description
6792000	4006885... ...679207	1 DSP 27 WSS - drawer organiser system



- content:
 - 1 cabinet door incl. lock
 - 2 shelves for cabinet compartment
- packaging: shrinkwrapped with inlay



article no.	EAN	description
6783000	4006885... ...678309	1 cabinet set



- can be used as a side, back and partition wall
- for better appearance and as dust protection
- required for supporting shelves in cabinet compartments (3 sets)
- packaging: folding box



article no.	EAN	description
6784000	4006885... ...678408	1 wall set

CLAMPING TABLES AND WORKBENCHES

2.3 Workshop System



- for workbench (1 module)
- packaging: bulk



article no.	EAN	description
6077000	4006885... ...607705	1 shelf



- for extending the workbench by 1 module
- content:
 - 1 pair of legs
 - 2 standard feet, insertable
 - 1 extension plate with joiner
- packaging: covering box



article no.	EAN	description
6788000	4006885... ...678804	1 extension set



- for additionally fastening the workbench to the wall
- for enhanced stability!
- packaging: plastic bag on card

article no.	EAN	description
6074000	4006885... ...607408	1 wall fixation set



- packaging: plastic bag on card

article no.	EAN	description
6075000	4006885... ...607507	1 workplate connector set

CLAMPING TABLES AND WORKBENCHES 2

2.3 Workshop System



- adapter plate for mounting stationary devices such as drill stands, vices, etc.
- fast attachment and detachment via eccentric lever
- packaging: shrinkwrapped with inlay



article no.	EAN	description
6065000	4006885... ...606500	1 quick change adapter set

Pre-assembled workbenches

Workbench kits in different sizes and executions. Supplied as individual components with assembly instructions. Quick-assembly system: workbench panels are pre-drilled, nuts are pre-assembled and flush-mounted

- sturdy and professional workbench
- legs made from strong 40 x 40 mm square tube
- all steel parts made from steel up to 2 mm thick
- maximum table load 600 kg
- 30 mm table top made from beechwood, laminated
- smooth-glide drawers made from highly impact resistant plastic, maximum load 25 kg
- drawers can be removed at any time for quick transportation of tools to the job site.
- height-adjustable foot for the compensation of floor irregularities



- working height 860 mm
- bench top 650 x 650 mm
- content:
1 drawer M
1 cabinet compartment
- weight: 31.8 kg



article no.	EAN	description	product dimensions
8051000	4006885... ...805101	1 workbench, 650 mm, No. 1	650 x 650 x 860 mm

CLAMPING TABLES AND WORKBENCHES

2.3 Workshop System



- working height 860 mm
- bench top 650 x 650 mm
- content:
 - 2 drawers S
 - 1 cabinet compartment
- weight: 32.8 kg

10



article no.	EAN	description	product dimensions
8052000	4006885... ...805200	1 workbench, 650 mm, No. 2	650 x 650 x 860 mm



- working height 860 mm
- bench top 650 x 650 mm
- content:
 - 2 drawers M
 - 1 drawer L
- weight: 33.6 kg

10



article no.	EAN	description	product dimensions
8053000	4006885... ...805309	1 workbench, 650 mm, No. 3	650 x 650 x 860 mm



- working height 860 mm
- bench top 650 x 650 mm
- content: 4 drawers M
- weight: 36.5 kg

10



article no.	EAN	description	product dimensions
8054000	4006885... ...805408	1 workbench, 650 mm, No. 4	650 x 650 x 860 mm



- version: with seating
- working height 860 mm
- bench top 1.130 x 650 mm
- content:
 - 2 drawers M
 - 1 drawer L
- weight: 45.7 kg

10



article no.	EAN	description	product dimensions
8060000	4006885... ...806009	1 workbench, 1130 mm, No. 1	1,130 x 650 x 860 mm

CLAMPING TABLES AND WORKBENCHES 2

2.3 Workshop System



- working height 860 mm
- bench top 1.130 x 650 mm
- content:
 - 2 drawers M
 - 2 support bases
- weight: 44.1 kg



article no.	EAN	description	product dimensions
8061000	4006885... ...806108	1 workbench, 1130 mm, No. 2	1,130 x 650 x 860 mm



- working height 860 mm
- bench top 1.130 x 650 mm
- content:
 - 3 drawers M
 - 1 cabinet compartment
 - 2 support bases
- weight: 54.9 kg



article no.	EAN	description	product dimensions
8062000	4006885... ...806207	1 workbench, 1130 mm, No. 3	1,130 x 650 x 860 mm



- working height 860 mm
- bench top 1.130 x 650 mm
- content:
 - 2 drawers S
 - 2 drawers M
 - 1 drawer L
 - 1 cabinet compartment
- weight: 56.3 kg



article no.	EAN	description	product dimensions
8063000	4006885... ...806306	1 WSS 640 - workbench, 1130 mm	1,130 x 650 x 860 mm



- version: with seating
- working height 860 mm
- bench top 1.130 x 650 mm
- content: 4 drawers M
- weight: 48.6 kg



article no.	EAN	description	product dimensions
8064000	4006885... ...806405	1 workbench, 1130 mm, No. 5	1,130 x 650 x 860 mm

CLAMPING TABLES AND WORKBENCHES

2.3 Workshop System



- version: with seating
- working height 860 mm
- bench top 1.130 x 650 mm
- content:
 - 1 drawer M
 - 1 cabinet compartment
- weight: 43.9 kg

10



article no.	EAN	description	product dimensions
8065000	4006885... ...806504	1 workbench, 1130 mm, No. 6	1,130 x 650 x 860 mm



- working height 860 mm
- bench top 1.130 x 650 mm
- content:
 - 2 drawers S
 - 1 drawer M
 - 2 cabinet compartments
- weight: 54.5 kg

10



article no.	EAN	description	product dimensions
8066000	4006885... ...806603	1 workbench, 1130 mm, No. 7	1,130 x 650 x 860 mm



- working height 860 mm
- bench top 1.130 x 650 mm
- content:
 - 2 drawers S
 - 4 drawers M
 - 1 cabinet compartment
- weight: 59.2 kg

10



article no.	EAN	description	product dimensions
8067000	4006885... ...806702	1 workbench, 1130 mm, No. 8	1,130 x 650 x 860 mm



- working height 860 mm
- bench top 1.130 x 650 mm
- content:
 - 6 drawers M
 - 2 support bases
- weight: 58.7 kg

10



article no.	EAN	description	product dimensions
8068000	4006885... ...806801	1 workbench, 1130 mm, No. 9	1,130 x 650 x 860 mm

CLAMPING TABLES AND WORKBENCHES

2.3 Workshop System

2



- working height 860 mm
- bench top 1.130 x 650 mm
- content: 8 drawers M
- weight: 62.1 kg



article no.	EAN	description	product dimensions
8069000	4006885... ...806900	1 WSS 680 - workbench, 1130 mm	1,130 x 650 x 860 mm

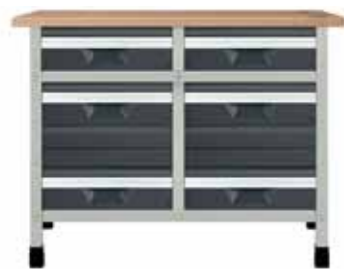

- working height 860 mm
- bench top 1.130 x 650 mm
- content:
4 drawers M
2 drawers L
- weight: 56.2 kg



article no.	EAN	description	product dimensions
8070000	4006885... ...807006	1 workbench, 1130 mm, No. 11	1,130 x 650 x 860 mm



- working height 860 mm
- bench top 1.130 x 650 mm
- content:
5 drawers M
1 cabinet compartment
- weight: 58.3 kg



article no.	EAN	description	product dimensions
8071000	4006885... ...807105	1 workbench, 1130 mm, No. 12	1,130 x 650 x 860 mm



- working height 860 mm
- bench top 1.130 x 650 mm
- content:
2 drawers M
2 cabinet compartments
- weight: 54.4 kg



article no.	EAN	description	product dimensions
8072000	4006885... ...807204	1 WSS 620 - workbench, 1130 mm	1,130 x 650 x 860 mm

2.3 Workshop System



- working height 860 mm
- bench top 1.610 x 650 mm
- content:
6 drawers S
9 drawers M
- weight: 90 kg

10



article no.	EAN	description	product dimensions
8075000	4006885... ...807501	1 workbench, 1610 mm, No. 1	1,610 x 650 x 860 mm



- working height 860 mm
- bench top 1.610 x 650 mm
- content:
8 drawers M
2 drawers L
- weight: 81.2 kg

10



article no.	EAN	description	product dimensions
8076000	4006885... ...807600	1 workbench, 1610 mm, No. 2	1,610 x 650 x 860 mm



- working height 860 mm
- bench top 1.610 x 650 mm
- content:
5 drawers M
2 drawers L
1 cabinet compartment
- weight: 78.3 kg

10



article no.	EAN	description	product dimensions
8077000	4006885... ...807709	1 workbench, 1610 mm, No. 3	1,610 x 650 x 860 mm



- version: with seating
- working height 860 mm
- bench top 1.610 x 650 mm
- content:
4 drawers S
2 drawers M
2 drawers L
- weight: 75.3 kg

10



article no.	EAN	description	product dimensions
8078000	4006885... ...807808	1 workbench, 1610 mm, No. 4	1,610 x 650 x 860 mm

CLAMPING TABLES AND WORKBENCHES 2

2.3 Workshop System



- working height 860 mm
- bench top 1.610 x 650 mm
- content:
6 drawers M
2 cabinet compartments
- weight: 79.5 kg



article no.	EAN	description	product dimensions
8079000	4006885... ...807907	1 workbench, 1610 mm, No. 5	1,610 x 650 x 860 mm



- working height 860 mm
- bench top 1.610 x 650 mm
- content:
3 drawers M
3 cabinet compartments
- weight: 74.7 kg



article no.	EAN	description	product dimensions
8080000	4006885... ...808003	1 workbench, 1610 mm, No. 6	1,610 x 650 x 860 mm

Pegboard and cabinet system



- for storing tools, paints, materials, etc.
- extra deep, spacious interior
- doors made from high quality plastic, lockable
- made of high-quality materials for excellent stability
- max. loading 50 kg
- 120 l volume
- including:
MDF shelf
wall mounting material
- packaging: covering box
- weight: 20 kg



article no.	EAN	description	product dimensions
6073000	4006885... ...607309	1 wall unit	985 x 500 x 300 mm

2.3 Workshop System

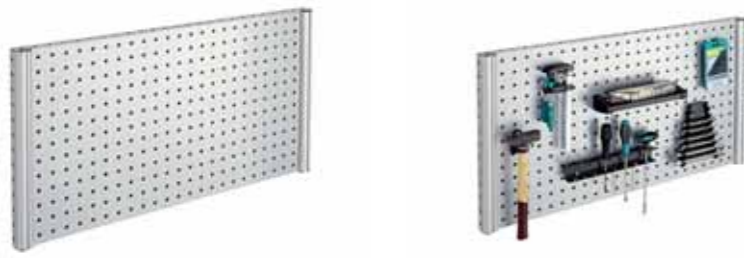

- practical and convenient storage of tools on the wall - always ready to hand
- attachment of tools via various system hooks
- version: hole pattern, 9 mm (square), grid dimensions 38 x 38 mm
- material: made from steel and aluminium elements
- max. loading 50 kg
- including: wall mounting material
- packaging: covering box
- weight: 5 kg
- separate accessories: 6091000, 6092000, 6093000, 6094000, 6099000, 6800000, 6801000, 6802000, 6803000, 6804000



article no.	EAN	description	product dimensions
6085000	4006885... ...608504	1 pegboard	960 x 500 mm



compact, space-saving solution: 3 perforated wall panels on a base panel

- attachment of tools via various system hooks
- with steel shelf
- doors: loadable to max. 5 kg, magnetic closure
- version: hole pattern, 9 mm (square), grid dimensions 38 x 38 mm
- material: made from steel and aluminium elements
- max. loading 60 kg
- 80 l volume
- including:
 - 10 pegboard hooks, each 3 parts Art. No. 6091000, 6092000, 6093000 + 1 part Art. No. 6094000
 - wall mounting material
- packaging: covering box
- weight: 12.5 kg
- separate accessories: 6091000, 6092000, 6093000, 6094000, 6099000, 6800000, 6801000, 6802000, 6803000, 6804000



article no.	EAN	description	product dimensions
6086000	4006885... ...608603	1 pegboard cabinet	960 x 500 x 215 mm

CLAMPING TABLES AND WORKBENCHES

2

2.3 Workshop System



- for storing spanners
- packaging: plastic bag on card
- suitable for 6085000, 6086000

article no.	EAN	description
6800000	4006885... ...680005	1 spanner holder



- for storing screwdrivers
- packaging: plastic bag on card
- suitable for 6085000, 6086000

article no.	EAN	description
6801000	4006885... ...680104	1 screwdriver holder



- for storing drills
- packaging: plastic bag on card
- suitable for 6085000, 6086000

article no.	EAN	description
6804000	4006885... ...680401	1 drill holder



- packaging: plastic bag on card
- suitable for 6085000, 6086000

article no.	EAN	description	product dimensions
6802000	4006885... ...680203	1 pegboard tray	377 mm

2 CLAMPING TABLES AND WORKBENCHES

2.3 Workshop System



- bracket for hanging various tools
- packaging: plastic bag on card
- suitable for 6085000, 6086000

article no.	EAN	description	product dimensions
6803000	4006885... ...680302	1 pegboard bracket	377 mm



- max. loading 2 kg
- packaging: plastic bag on card
- suitable for 6085000, 6086000

article no.	EAN	description	length
6091000	4006885... ...609105	5 pegboard single hooks	30 mm
6093000	...609303	5 pegboard single hooks	50 mm
6099000	...609907	10 pegboard single hooks	60 mm



- max. loading 2 kg
- packaging: plastic bag on card
- suitable for 6085000, 6086000

article no.	EAN	description	product dimensions
6092000	4006885... ...609204	5 pegboard loop hooks	35 x 35 mm



- max. loading 2 kg
- packaging: plastic bag on card
- suitable for 6085000, 6086000

article no.	EAN	description	product dimensions
6094000	4006885... ...609402	3 pegboard double hooks	35 x 60 mm

CLAMPING TABLES AND WORKBENCHES 2

2.3 Workshop System



- for easy and safe storage of metal tools
- suitable for screwdrivers, hammers, pliers, files, etc.
- two plastic holders for easy mounting on the wall
- usable length: 460 mm, individually extendable to 920 mm, 1380 mm, etc.
- max. loading 13 kg
- content:
 - 1 magnetic strip
 - 2 plastic holders
 - 4 screwing
- packaging: blister on card

article no.	EAN	description	product dimensions
6806000	4006885... ...680609	1 magnetic tool ledge	35 x 500 mm

3 TRANSPORT SYSTEMS



TRANSPORT SYSTEMS 3

3.1 Hand Trucks

The allrounder - hand truck and wheelbarrow in one 1 TS 1000 - transport system



convertible from its hand truck function into a wheelbarrow with a flick of the wrist



can be folded for space-saving storage



hand truck function



wheelbarrow function



can be stored in a compact manner



function hand truck

- various handle positions enable optimal tilting and shipping operations
- handles with protective hoops
- high resting surface; ideal for high objects / top-heavy loads

function wheelbarrow

- easy to load due to low loading height
- the simple exchange of various containers through the system outclasses wheelbarrow
- high resting surface; ideal for high objects / top-heavy loads
- convertible from its hand truck function into a wheelbarrow with a flick of the wrist
- round transverse rods and rear panel for securing round objects in a tight position
- with the shovel lowered ideal for transporting longer objects
- pneumatic tyres for easy and comfortable transporting
- suitable for being used on steps: adjustable tilting angle for retaining the load in an optimal position in all situations
- tilt-resistant shipment even of heavy loads
- ideal for heavy garden furniture, firewood, etc.
- packaging: covering box



Technical data

max. load hand truck function: 150 kg
 max. load wheelbarrow function: 200 kg
 dimensions mounted: 610 x 1,260 x 550 mm
 dimensions folded: 610 x 800 x 520 mm
 weight: 15 kg

article no.	EAN	description
5520000	4006885... ...552005	1 TS 1000 - transport system

3 TRANSPORT SYSTEMS

3.1 Hand Trucks

The high-performance professional hand truck – foldable and suitable for use on stairs

1 TS 1500 - transport system



- extra large base plate for transporting large objects such as washing machines, fridges, etc.
- comfortable and safe transport of heavy loads thanks to ergonomic handles
- despite the maximum load of 200 kg, the transport system is easy to fold together thanks to the unique folding mechanism and can be stored effortlessly
- extendible handlebar with central locking system

port thanks to large foam wheels, each with 2 integrated ball bearings

- rounded crossbars and rear panel for the safe transport of round items
- packaging: sleeve
- separate accessories: 5528000



Technical data

version:	base plate load-bearing area 590 x 370 mm
max. height:	1,240 mm
max. load hand truck function:	200 kg
maximum load capacity of the step function:	100 kg
dimensions mounted:	660 x 1,240 mm
dimensions folded:	600 x 990 x 110 mm
weight:	10.4 kg

article no.	EAN	description
5525000	4006885...5525000	1 TS 1500 - transport system

TRANSPORT SYSTEMS 3

3.1 Hand Trucks

The hand truck for all your needs – convenient and space-saving
1 TS 850 - transport system



- thanks to the clever fast-fold mechanism always close at hand
- retractable handlebar with central lock button for convenient use
- easy tilting with the sturdy transverse rod
- rounded pivot bar - ideal for transporting round objects
- rounded handle bar for the comfortable handling of even bulky items
- highly versatile, thanks to the smart 3-point fixings with many fitting options
- the height of 110 cm allows easy handling and transportation
- large profile wheels suitable for use on steps and outside
- packaging: sleeve
- separate accessories: 5528000



Technical data

max. height:	1,100 mm
max. load hand truck function:	100 kg
maximum load capacity of the step function:	50 kg
dimensions mounted:	540 x 1,110 x 470 mm
dimensions folded:	500 x 820 x 77 mm
weight:	5.6 kg

article no.	EAN	description
5501000	4006885...550100	1 TS 850 - transport system

3 TRANSPORT SYSTEMS

3.1 Hand Trucks

The mobile hand truck – foldable and sturdy
1 TS 600 - transport system



- thanks to the folding mechanism wheels and base plate open with a single action
- compact when folded
- with variable height adjustment for easier handling
- rounded pivot bar - ideal for transporting round objects
- rounded handle bar for the comfortable handling of even bulky items
- highly versatile, thanks to the smart 2-point fixings with many fitting options
- very easy to handle, due to a low weight of only 3.9 kg
- packaging: sleeve



Technical data

max. height:	1,050 mm
max. load hand truck function:	70 kg
maximum load capacity of the step function:	40 kg
dimensions mounted:	430 x 1,050 x 445 mm
dimensions folded:	430 x 730 x 60 mm
weight:	3.9 kg

article no.	EAN	description
5505000	4006885... ...550506	1 TS 600 - transport system

TRANSPORT SYSTEMS 3

3.1 Hand Trucks

The "small but tough" hand truck
1 TS 300 - transport system



Multiple foldable transport system! Easy to use - compact, requires almost no space in the trunk. The low weight makes it the perfect companion for shopping.

- two steps continuously variable height adjustment
- wheels and plate open with a single grip, due to the special folding mechanism
- 4 point - plastic rear panel
- very compact, only 60 mm flat when folded, therefore, always ready to use out of the boot or other compartments
- packaging: sleeve



Technical data

max. height: 910 mm
 max. load hand truck function: 30 kg
 dimensions mounted: 340 x 910 x 370 mm
 dimensions folded: 340 x 510 x 60 mm
 weight: 3 kg

article no.	EAN	description
5530000	4006885... ...553002	1 TS 300 - transport system

3 TRANSPORT SYSTEMS

3.1 Hand Trucks

1 carrying handle TS



- stairclimbing aid for heavy loads up to 100 kg
- turns a hand truck into a 2-person transport system
- sturdy, resilient steel frame
- ergonomic handle shape for comfortable carrying
- packaging: paperboard card
- dimensions mounted: 396 x 305 x 891 mm
- suitable for 5501000, 5525000

article no.	EAN	description
5528000	4006885... ...552807	1 carrying handle TS

TRANSPORT SYSTEMS 3

3.3 Removal helpers

The convertible removal helper
1 FT 350 B - furniture dolly, splittable, with handle



Furniture dolly with 5-in-1 function:
 panel cart and flat trolley or furniture
 dolly with three different load-bearing
 surfaces



- can be used as a panel cart for heavy loads up to 50 kg
- can be used as a flat trolley for long boards or items of furniture up to 150 kg
- ideal for transporting heavy loads up to 300 kg as a compact furniture dolly
- load-bearing area can be extended in a V-shape for loads up to 200 kg
- splittable for transporting large pieces of furniture up to 200 kg secured with a strap
- high-quality, durable birch plywood bonded with waterproof glue
- ergonomic recessed grips
- secure hold with 4 non-slip support rests
- flexible steering thanks to 6 ball-bearing mounted 360° castors ø 75 mm
- ideal for removals, home and garden
- including: 2 Stopper for securing the load
- packaging: sleeve
- dimensions mounted: 565 x 960 x 390 mm
- weight: 6.48 kg

article no.	EAN	description
5548000	4006885... ...554801	1 FT 350 B - furniture dolly, splittable, with handle

3 TRANSPORT SYSTEMS

3.3 Removal helpers



The flexible removal helper
 Furniture dolly with 3-in-1 function: compact, split or V-shaped extension

- offers three load-bearing areas of different sizes
- compact board ideal for transporting heavy loads up to 250 kg
- load-bearing area can be extended in a V-shape for loads up to 250 kg
- splittable for transporting large pieces of furniture up to 200 kg secured with a strap
- high-quality, durable birch plywood bonded with waterproof glue
- ergonomic recessed grips
- secure hold with 6 non-slip support rests
- flexible steering thanks to 6 ball-bearing mounted 360° castors ø 75 mm
- ideal for removals, home and garden
- version: load surface when closed: 565 x 390 mm
- packaging: sleeve
- dimensions mounted: 565 x 120 x 390 mm
- weight: 3.93 kg

article no.	EAN	description
5542000	4006885... ...554207	1 FT 300 - furniture dolly, splittable

TRANSPORT SYSTEMS 3

3.3 Removal helpers



The modular removal helper set consisting of two furniture dollies, can be extended as desired

- can be used individually and split
- for loads up to 400 kg
- modular system can be extended as desired with additional brackets and boards
- high-quality, durable birch plywood bonded with waterproof glue
- ergonomic recessed grips
- secure hold with 4 non-slip support rests each
- flexible steering thanks to 4 ball-bearing mounted 360° castors ø 75 mm
- ideal for removals, home and garden
- dimensions per board: 590 x 120 x 290 mm
- packaging: sleeve
- weight: 5.25 kg



article no.	EAN	description
5543000	...554306	2 FT 400 - puzzle board furniture dollies



For carrying tools close at hand on a belt.

- can be attached to any belt or the waist belt of the wolfcraft carrying belt system
- enough space for the necessary tools and small parts
- fast access
- durable thanks to hard-wearing polypropylene, riveted welded knot and circumferential piping
- version: large pocket with interior compartments, pocket for small parts, loops for screwdrivers, pliers and hammer
- packaging: plastic bag on card

article no.	EAN	description
5584000	...558403	1 tool bag

3 TRANSPORT SYSTEMS

3.3 Removal helpers



- Removal and everyday helper for carrying loads without fatigue or back strain
- for carrying removal boxes without back strain or fatigue
 - as an everyday helper for beverage crates, laundry baskets and shopping baskets
 - shoulder and waist straps ensure an ergonomic load distribution
 - up to 75% less exertion in the arms
 - transport item is carried close to the body
 - full leg mobility when going up or down stairs
 - comfortable shoulder and inner padding
 - perfect fit thanks to adjustable chest strap
 - can be individually adapted to the body size
 - fold-out support panel
 - packaging: covering box
 - weight: 0.73 kg

article no.	EAN	description
5582000	4006885... ...558205	1 carrying belt system



- Protection and grip when gripping and carrying angular objects.
- protects the palms and wrists from pressure marks caused by hard, uncomfortable edges
 - offers the best grip on smooth surfaces
 - thumb free for controlled gripping
 - simply fold down to quickly free fingers
 - sturdy design made from tear-resistant, high-quality neoprene, fully lined
 - practical Velcro faster with rubber strap for additional grip
 - one size: fits all hand sizes (S - XL)
 - packaging: paperboard card

article no.	EAN	description
5546000	4006885... ...554603	1 pair of hand protectors

TRANSPORT SYSTEMS 3

3.3 Removal helpers



2-in-1 function: stacking aid and lid clamp

For fast and safe stacking of same-size boxes and comfortable loading and unloading.

- suitable for all boxes up to a material thickness of 6 mm
- max. load of 30 kg per carton
- 8 stacking corners for stacking 3 boxes
- orderly appearance and stable storage
- ideal for transport
- best stability thanks to plastic spike for locating at the corner of the box
- convenient loading of boxes thanks to clamping function for securing the lid of the box
- unbreakable design made of high-quality, strong plastic material
- packaging: plastic bag on card

article no.	EAN	description
5544000	4006885...554405	8 stacking corners



2-in-1 function: marking aid and lid clamp

For fast and clean marking of removal boxes and convenient loading and unloading.

- unambiguous marking of packed boxes using colour codes and living room pictograms
- convenient loading of boxes thanks to clamping function for securing the lid of the box
- boxes remain unscathed, ideal for later reuse or sale
- space for individual labelling on the back
- unbreakable design made of high-quality, strong plastic material
- content:
 - 4 clips with bathroom pictogram
 - 4 clips with kitchen pictogram
 - 4 clips with nursery pictogram
 - 4 clips with bedroom pictogram
 - 4 clips with living room pictogram
 - 10 non-specific clips, unlabelled
- packaging: plastic bag on card

article no.	EAN	description
5545000	4006885...554504	30 removal clips



CLAMPING TOOLS

4.1 One-hand clamps

4

EHZ PRO 100 One-hand clamps

The powerful for professional work



effortless conversion to the spreading function



most simple handling and secure fastening due to ergonomic grip with skid-resistant zone

- quick, safe and convenient clamping - with just one hand
- robust and powerful - clamping pressure up to 120 kg
- most simple handling and secure fastening due to ergonomic grip with skid-resistant zone
- for professionals: effortless conversion to the spreading function by pushing a button
- even distribution of the clamping force and gentle to the workpiece thanks to large clamping areas and extreme 100 mm clearance
- high-quality rail that ensures high, long lasting clamping force
- very easy release of the clamping pressure due to optimum leverage
- cross groove for safely clamping round objects
- adjustable spacers protect the workpiece and serve as support
- packaging: with hang tag
- separate accessories: 3037000, 3038000



article no.	EAN	description	depth	clamping width	expanding range
3030000	...303003	1 EHZ PRO 100-150 - one-hand clamp	100 mm	150 mm	210 - 410 mm
3031000	...303102	1 EHZ PRO 100-300 - one-hand clamp	100 mm	300 mm	210 - 560 mm
3032000	...303201	1 EHZ PRO 100-450 - one-hand clamp	100 mm	450 mm	210 - 710 mm
3033000	...303300	1 EHZ PRO 100-700 - one-hand clamp	100 mm	700 mm	210 - 960 mm
3034000	...303409	1 EHZ PRO 100-915 - one-hand clamp	100 mm	915 mm	210 - 1,175 mm

4 CLAMPING TOOLS

4.1 One-hand clamps

EHZ PRO 65 One-hand clamps



quick, safe and convenient clamping - with just one hand



for professionals: effortless conversion to the spreading function by pushing a button

The powerful for professional work



- quick, safe and convenient clamping - with just one hand
- robust and powerful - clamping pressure up to 90 kg
- most simple handling and secure fastening due to ergonomic grip with skid-resistant zone
- for professionals: effortless conversion to the spreading function by pushing a button
- even distribution of the clamping force and gentle to the workpiece thanks to large clamping areas and 65 mm throat clearance
- high-quality rail that ensures high, long lasting clamping force
- very easy release of the clamping pressure due to optimum leverage
- cross groove for safely clamping round objects
- packaging: with hang tag
- separate accessories: 3037000

article no.	EAN	description	depth	clamping width	expanding range
3456000	4006885...345607	1 EHZ 65-150 - one-hand clamp	65 mm	150 mm	160 - 320 mm
3457000	4006885...345706	1 EHZ 65-300 - one-hand clamp	65 mm	300 mm	160 - 470 mm

EHZ Miniature one-hand clamps



The one-hand clamp's little brother



The miniature one-hand clamp possesses all of the technical advantages of its larger counterpart.

- for the quick and precise clamping of small work pieces, e.g. for model-making
- packaging: fixed on card

article no.	EAN	description	depth	clamping width	expanding range
3455100	4006885...345515	2 EHZ 40-110 - miniature one-hand clamps	40 mm	110 mm	100 - 210 mm

CLAMPING TOOLS 4

4.1 One-hand clamps

EHZ Easy One-hand clamps



effortless conversion to the spreading function



One-handed - inexpensive - simply ingenious

The inexpensive alternative - ideal for all beginners and occasional do-it-yourselfers.

- most simple handling, with the basic functions of clamping and releasing
- up to 90 kg clamping force
- due to an optimized ergonomic grip, the clamp is always comfortably positioned in the hand
- effortless conversion to the spreading function
- tempered steel and glass fibre reinforced plastic
- packaging: with hang tag
- separate accessories: 3037000, 3038000

article no.	EAN	description	depth	clamping width	expanding range
3020000	4006885...302006	1 EHZ Easy 75-150 - one-hand clamp	75 mm	150 mm	180 - 390 mm
3021000	4006885...302105	1 EHZ Easy 75-300 - one-hand clamp	75 mm	300 mm	180 - 540 mm
3023000	4006885...302303	1 EHZ Easy 75-500 - one-hand clamp	75 mm	500 mm	180 - 740 mm



- for combining two one-hand clamps (PRO art. no. 3030000-3034000 or Easy art. no. 3020000-3023000)
- enables spans up to 200 cm (with 2 PRO 100-915 one-hand clamps + adapter)
- ideal for gluing furniture or attaching large components
- packaging: fixed on card
- suitable for 3020000, 3021000, 3023000, 3030000, 3031000, 3032000, 3033000, 3034000



article no.	EAN	description
3038000	4006885...303805	1 Connector PRO/Easy - one hand clamp adapter

4 CLAMPING TOOLS

4.3 Screw clamps

SZ Screw clamps

The classic tool in a new functional design



new clamping arm geometry allows the tool to be laid flat on the back - particularly good for gluing



handle ergonomically formed with non-slip inserts, for optimal power transfer

Ergonomic, with innovative features, for a variety of applications - as relevant now as ever.

- handle ergonomically formed with non-slip inserts, for optimal power transfer
- optimal transfer of power via a galvanised spindle with trapezoidal thread
- new clamping arm geometry allows the tool to be laid flat on the back - particularly good for gluing
- will not slip or come undone - grooved edges will ensure a secure grip
- the high-quality galvanised cavity-profile clamp arm will not bend, even when working at large spans
- packaging: with hang tag
- separate accessories: 3037000

article no.	EAN 4006885...	description	depth	clamping width
3610000	...361003	1 SZ 80-150 - screw clamp	80 mm	150 mm
3611000	...361102	1 SZ 80-300 - screw clamp	80 mm	300 mm
3612000	...361201	1 SZ 80-450 - screw clamp	80 mm	450 mm
3620000	...362000	1 SZ 120-300 - screw clamp	120 mm	300 mm
3621000	...362109	1 SZ 120-450 - screw clamp	120 mm	450 mm
3622000	...362208	1 SZ 120-700 - screw clamp	120 mm	700 mm
3623000	...362307	1 SZ 120-1000 - screw clamp	120 mm	1,000 mm

CLAMPING TOOLS 4

4.3 Screw clamps

SZ Handicraft screw clamps



- clamp arm made of special pressure die-cast zinc
- profile rail, non-slip thanks to grooving on both sides
- upper clamp arm has a stable surface - ideal for gluing
- galvanised spindle with trapezoidal thread
- adjustable pressure plate made of glass fibre-reinforced polyamide
- packaging: with hang tag
- separate accessories: 3037000

article no.	EAN 4006885...	description	depth	clamping width
3607000	...360709	1 SZ 50-100 - handicraft screw clamp	50 mm	100 mm
3606000	...360600	1 SZ 50-150 - handicraft screw clamp	50 mm	150 mm
3605000	...360501	1 SZ 50-200 - handicraft screw clamp	50 mm	200 mm

SC Screw clamps

Good starter quality with outstanding value for money



- clamping jaws made of malleable cast iron and reinforced by a corrugation profile
- the rail is reinforced by a hollow profile
- the corrugated rail prevents skidding
- with plastic handle
- packaging: sticker
- separate accessories: 3037000

article no.	EAN 4006885...	description	depth	clamping width
3057000	...305700	1 SC 80-150 - screw clamp	80 mm	150 mm
3058000	...305809	1 SC 80-200 - screw clamp	80 mm	200 mm
3059000	...305908	1 SC 80-300 - screw clamp	80 mm	300 mm

4.4 Spring clamps plastic



movable clamping jaws adjust to the workpiece

- movable clamping jaws adjust to the workpiece
- V-grooves at right angles for gripping round workpieces
- packaging: with hang tag



article no.	EAN	description	clamping width
3630000	4006885... ...363007	1 FZ 40 - spring clamp	40 mm
3631000	...363106	1 FZ 60 - spring clamp	60 mm



large depth offered by the long clamp arms allows fixing in areas far away from the edge of the workpiece

Universal clamp for extremely precise fixing

- long tapered clamp arms will make fixing in confined spaces easy
- large depth offered by the long clamp arms allows fixing in areas far away from the edge of the workpiece
- packaging: with hang tag



article no.	EAN	description	clamping width
3633000	4006885... ...363304	1 MT 70 - pointed spring clamp	70 mm

CLAMPING TOOLS 4

4.4 Spring clamps plastic



- thanks to the ergonomic shape of the grip you can work without getting exhausted despite frequently changing the fixation
- 360° turnable hook, suitable for the fixation of nets, decorations, lamps and cables with a diameter up to 25 mm
- articulated clamping jaws for perfect contact to the surface
- jaws with V-groove for secure clamping of round workpieces
- with hook, maximum load 5 kg
- packaging: with hang tag



article no.	EAN	description	clamping width
3629000	4006885... ...362901	1 FZH 50 - spring clamp	50 mm



3625000



3626000



Classic spring clamps in new ergonomic shape

- offers various new applications
- ideal for home decoration, hobbies, camping and other applications
- ideal for clamping in small gaps
- articulated clamping jaws for perfect contact to the surface
- jaws with V-groove for secure clamping of round workpieces
- packaging: with hang tag

article no.	EAN	description	clamping width
3625000	4006885... ...362505	1 FZH 30 - ergo spring clamp	30 mm
3626000	4006885... ...362604	1 FZH 40 - ergo spring clamp	40 mm

4.4 Spring clamps plastic



- can be used everywhere, especially suitable for model makers
- ensures a secure grip in a thousand and one different situations
- movable clamping jaws adjust to the workpiece
- in various colours

article no.	EAN	description	clamping width	including	packaging
	4006885...				
3425000	...342507	1 microfix - mini spring clamp	20 mm		with hang tag
3420000	...342002	6 microfix - mini spring clamps	20 mm	1 key-ring	blister on card
3433000	...343306	1 microfix - spring clamp	30 mm		with hang tag
3432000	...343207	4 microfix - spring clamps	30 mm		fixed on card

**microfix Spring clamps with suction cup**

The clamp is suitable as a temporary fixing option on all smooth surfaces.

- usable in all households, suitable for hobby, garden, car and leisure (camping)
- clean fixing - when releasing no residues remain on the surface
- movable clamping jaws adjust to the workpiece
- easy fixation on smooth surfaces thanks to rocker arm mechanism
- version: with suction cup
- in various colours

article no.	EAN	description	clamping width	holding force	packaging
	4006885...				
3662000	...366206	1 microfix S - mini spring clamp	20 mm	250 g	with hang tag
3663000	...366305	4 microfix S - mini spring clamps	20 mm	250 g	fixed on card
3638000	...363809	1 microfix - spring clamp	30 mm	350 g	with hang tag
3638100	...363816	2 microfix - spring clamps	30 mm	350 g	fixed on card

CLAMPING TOOLS 4

4.4 Spring clamps plastic



microfix Spring clamps with magnet

The spring clamp with magnet clings on all magnetic surfaces and can also be used for heavy or bulky jobs involving oddly-shaped things.

- usable in all households, where shopping lists, invitations, postcards, pictures etc. are to be kept well-arranged and/or within easy reach
- version: with magnet
- in various colours
- packaging: with hang tag

article no.	EAN	description	clamping width	holding force
3010000	4006885... ...301009	1 microfix XS - mini spring clamp	15 mm	50 g



long, thin clamping arms for working in places difficult to access

The precision spring clamp for extremely accurate fixing

- for precision jobs in model-making and any other intricate work
- long, thin clamping arms for working in places difficult to access
- tapered jaws
- soft plastic jaws have a specially structured surface, ensuring a secure grip
- packaging: fixed on card



article no.	EAN	description	clamping width
3431000	4006885... ...343108	2 microtip 60 - precision spring clamps	60 mm

4 CLAMPING TOOLS

4.5 Ratchet clamps



large depth offered by the long clamp arms allows fixing in areas far away from the edge of the workpiece

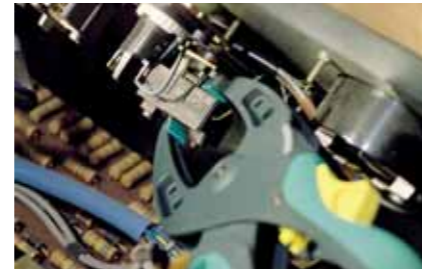

long tapered clamp arms will make fixing in confined spaces easy

The quick fixing aid

Not only for the sensitive fixing of workpieces with delicate surfaces... but also for powerful clamping with up to twice the force of a conventional springclamp

- large depth offered by the long clamp arms allows fixing in areas far away from the edge of the workpiece
- long tapered clamp arms will make fixing in confined spaces easy
- fibreglass reinforced high-performance plastic
- non-slip handle inserts ensure a secure grip
- packaging: double blister



article no.	EAN	description	clamping width
3634000	...363403	1 MTR 70 - pointed ratchet lever	70 mm



Not only for the sensitive fixing of workpieces with delicate surfaces... but also for powerful clamping with up to twice the force of a conventional springclamp



angled clamp arms ensure the optimal application of pressure and give maximum clamping range

The quick fixing aid

Not only for the sensitive fixing of workpieces with delicate surfaces... but also for powerful clamping with up to twice the force of a conventional springclamp

- angled clamp arms ensure the optimal application of pressure and give maximum clamping range
- articulated clamping jaws designed to avoid damage to the material with double groove for the crosswise clamping of round material
- fibreglass reinforced high-performance plastic
- non-slip handle inserts ensure a secure grip
- packaging: double blister



article no.	EAN	description	clamping width
3632000	...363205	1 FZR 50 - ratchet clamping lever	50 mm

CLAMPING TOOLS 4

4.5 Ratchet clamps



angled clamp arms ensure the optimal application of pressure and give maximum clamping range



The perfect clamp for hobby or household repairs

- clamping pressure exactly adjustable - perfect for delicate parts
- articulated clamping jaws designed to avoid damage to the material with double groove for the crosswise clamping of round material
- angled clamp arms ensure the optimal application of pressure and give maximum clamping range
- non-slip handle inserts ensure a secure grip
- packaging: with hang tag

article no.	EAN	description	clamping width
3016000	4006885... ...301603	1 FZR 30 - ratchet clamp for the hobby	30 mm



Not only for the sensitive fixing of workpieces with delicate surfaces... but also for powerful clamping with up to twice the force of a conventional springclamp

- robust ratchet with patented mechanism for easy unlocking / opening
- wide variety of hobby, camping, workshop, garden and household uses
- packaging: with hang tag

article no.	EAN	description	clamping width
3615000	4006885... ...361508	1 FZR 40 - ratchet clamping lever	40 mm
3616000	4006885... ...361607	1 FZR 60 - ratchet clamping lever	60 mm

4 CLAMPING TOOLS

4.5 Ratchet clamps



The small, sensitive quick-action clamping tongs

- movable clamping jaws adjust to the workpiece
- easy release by pressing the button
- packaging: fixed on card



article no.	EAN	description	clamping width
3453000	4006885... ...345300	2 quickfix S 30 - fast clamping tools - miniature size	30 mm

4.6 Belt clamps

Ratchet tie-downs with rolling-up mechanism



3683000

3271000

- makes child's play of tensioning and reeling up the belt
- quick fixing with one pull, no laborious threading
- rolling-up mechanism for fast, torsion-free reeling up the belt
- according to DIN EN 12195-2:2001-02
- packaging: blister on card



article no.	EAN	description	version	clamping pressure	strap length	band width
3683000	4006885... ...368309	1 ratchet tie down	with rolling-up mechanism	100 kg	4 m	25 mm
3271000	...327108	1 ratchet tie down	with hook and rolling-up mechanism	100 kg	4 m	25 mm

CLAMPING TOOLS 4

4.6 Belt clamps

Ratchet tie-downs



3442000

3418000



- uncompromising safety and permanent quality control
- according to DIN EN 12195-2:2001-02
- packaging: blister on card

article no.	EAN 4006885...	description	version	clamping pressure	strap length	band width
3418000	...341807	1 ratchet tie down		180 kg	4 m	25 mm
3442000	...344204	1 ratchet tie down	with hook	180 kg	4 m	25 mm



- uncompromising safety and permanent quality control
- according to DIN EN 12195-2:2001-02
- packaging: sleeve

article no.	EAN 4006885...	description	version	clamping pressure	strap length	band width
3273000	...327306	1 ratchet tie down		1,000 kg	5 m	25 mm
3274000	...327405	1 ratchet tie down	with hook	1,000 kg	5 m	25 mm
3275000	...327504	1 ratchet tie down		2,000 kg	6 m	35 mm
3276000	...327603	1 ratchet tie down	with hook	2,000 kg	6 m	35 mm
3277000	...327702	1 ratchet tie down		4,000 kg	8 m	50 mm
3278000	...327801	1 ratchet tie down	with hook	4,000 kg	8 m	50 mm

Tightening straps



- ideal for bundling and tightening
- packaging: blister on card

article no.	EAN 4006885...	description	version	clamping pressure	strap length	band width
3421000	...342101	2 belt clamps	with spring clamp	120 kg	4 m	25 mm

4 CLAMPING TOOLS

4.6 Belt clamps



- ideal for bundling and tightening
- packaging: blister on card

article no.	EAN	description	version	strap length	band width
3280000	4006885... ...328006	2 tightening straps	with buckle	0.8 m	20 mm

4.7 Frame clamps



- the quick clamping aid for gluing picture frames, small furniture, etc.
- tearproof nylon cord
- packaging: plastic bag on card

article no.	EAN	description	strap length
3417000	4006885... ...341708	1 cord clamp	2 m



- with clamping jaws suitable as frame clamp
- without clamping jaws suitable as normal tie down
- including: 4 clamping jaws
- packaging: blister on card

article no.	EAN	description	strap length
3441000	4006885... ...344105	1 ratchet belt clamp	4 m

CLAMPING TOOLS 4

4.7 Frame clamps



- the ideal clamping aid for gluing picture frames, furniture, shelves and other workpieces
- tension infinitely adjustable via eccentric lever
- acme-threaded spindle for tight and secure re-tensioning
- extremely wear-resistant nylon strap
- including: 4 plastic vice jaws
- packaging: double blister

article no.	EAN	description	strap length
3416000	4006885... ...341609	1 belt clamp	4 m



The frame clamp with the practical one-hand operation - the second hand remains free for alignment!



- with an automatically rolling out band - ideal for a fast initial clamping
- the ratchet mechanism enables you to clamp in stages - from loose to a powerful secure fixing
- objects securely gripped thanks to the elastic clamping jaws
- ergonomic 2-component handle
- including: 4 plastic vice jaws
- packaging: double blister

article no.	EAN	description	strap length
3681000	4006885... ...368101	1 one-hand frame clamp	5 m

4.8 Hook and loop strips



The practical strips for quick fixing, bundling, fastening, ...

- packaging: paperboard card

article no.	EAN	description	strap length
3008000	4006885...300804	2 conexio M - hook and loop strips	0.6 m
3009000	4006885...300903	2 conexio L - hook and loop strips	1.2 m



- for the gentle fixing of plants indoors or outdoors
- for the individual cutting of lengths
- packaging: paperboard card

article no.	EAN	description	version	strap length
3285000	4006885...328501	1 re-closable tape	green, for gardening	5 m



- to sort and fix a thousand and one things in the house
- for the individual cutting of lengths
- packaging: paperboard card

article no.	EAN	description	version	strap length
3286000	4006885...328600	1 re-closable tape	black, for the household	5 m



self-adhesive fastening tape for re-closing as often as you please

- ideal for do-it-yourselfers and decorators
- for the individual cutting of lengths
- packaging: paperboard card

article no.	EAN	description	version	strap length
3287000	4006885...328709	1 hook and loop strip	self-adhesive	1 m

CLAMPING TOOLS

4.9 Tensioning rubber bands

4



- versatile use for camping or biking, in the car or at home
- high-quality design
- plastic hooks with metal core, sturdy and protecting the material
- packaging: plastic bag on card

article no.	EAN 4006885...	description	strap length	miscellaneous
3290000	...329003	2 tensioning rubber bands	0.4 m	rope diameter: 10 mm
3291000	...329102	2 tensioning rubber bands	0.7 m	rope diameter: 10 mm
3292000	...329201	2 tensioning rubber bands	1 m	rope diameter: 10 mm



- packaging: plastic bag on card

article no.	EAN 4006885...	description	strap length
3293000	...329300	5 tensioning rubber bands	0.5 m



- for tensioning and fixing tarpaulins
- individual length setting (max. 60 cm)
- version: with ball and hooks
- packaging: plastic bag on card

article no.	EAN 4006885...	description	strap length
3294000	...329409	5 elastic straps	0.6 m



- for tensioning and fixing tarpaulins
- version: with ball and loop
- packaging: plastic bag on card

article no.	EAN 4006885...	description	strap length
3295000	...329508	10 elastic straps	0.15 m

4 CLAMPING TOOLS

4.10 Corner clamps



- fast and simple fixing of boards and frames at an angle of 90°, like assembling shelves, small cupboards or frames
- mounting aid for screwing or gluing boards together
- for corner and T-joints, even with different board thicknesses
- for boards with a thickness of 10 - 22 mm
- single-hand operation - the second hand is kept free for the workpiece
- packaging: fixed on card



article no.	EAN	description
3051000	4006885... ...305106	2 ES 22 - corner clamps



For versatile and quick clamping - the "third hand" for every craftsman

- as clamping device for 90° corner joints, saw guide for 45° mitre cuts and workbench vice
- as assembly aid for the alignment and clamping of parts for nailing, welding or screwing
- packaging: fixed on card

article no.	EAN	description	clamping width	jaw width
3415000	4006885... ...341500	1 clamping mobile	65 mm	68 mm

CLAMPING TOOLS 4

4.11 Special clamping tools



- for fastening workpieces to the worktop
- for all workbenches with 20 mm bores in the worktop (fits all wolfcraft tables)
- including upper clamping jaw - can also be used as a normal one-hand clamp
- packaging: fixed on card
- suitable for 6177000, 6182000, 6902000, 6902506, 6902612, 6906000, 6906506, 6906612, 6908000

article no.	EAN	description	clamping width	clamping pressure
3036000	4006885... ...303607	1 PRO 65-150-W - work table clamp	120 mm	90 kg



- for attaching edging strips or veneers
- for point clamping on a surface (e.g. profile of a cupboard door)
- accessory for all bar clamps (one-hand clamps or screw clamps) with max. 8 x 30 mm bar
- extends the application range of bar clamps
- packaging: fixed on card
- suitable for 3020000, 3021000, 3023000, 3030000, 3031000, 3032000, 3033000, 3034000, 3057000, 3058000, 3059000, 3456000, 3457000, 3605000, 3606000, 3607000, 3610000, 3611000, 3612000, 3620000, 3621000, 3622000, 3623000

article no.	EAN	description	clamping width	clamping pressure
3037000	4006885... ...303706	2 KS 24 - edge clamps	24 mm	30 kg



WOOD JOINTS 5

5.1 Dowel connections

Dowel jointers



The universal and quick dowelling jig for corner, T-butt and edge-to-edge connections

- for 6, 8 and 10 mm dowel pins
- for board thicknesses from 12 - 30 mm
- packaging: double blister
- separate accessories: 2730000, 2731000, 2732000, 2733000, 2905000, 2906000, 2907000, 2908000, 2909000, 2910000, 7150000, 7151000, 7152000

article no.	EAN	description
4640000	4006885... ...464001	1 dowelmaster



- for drilling doweled connections, rows of boreholes in shelves & cupboards as well as hinges & fittings in furniture construction
- for the dowelling of boards with a length of up to 600 mm in one clamping position and a thickness of 12 - 40 mm
- with exchangeable drilling bushes of Ø 5, 6, 8 and 10 mm
- standardized bore pitch of 32 mm
- packaging: covering box
- separate accessories: 2730000, 2731000, 2732000, 2733000, 2905000, 2906000, 2907000, 2908000, 2909000, 2910000, 7150000, 7151000, 7152000

article no.	EAN	description
4650000	4006885... ...465008	1 dowelling jig

5 WOOD JOINTS

5.1 Dowel connections



Simply clamp, drill and dowel the parts together - no measuring and marking

- for 6, 8 and 10 mm dowel pins
- for board thicknesses from 12 - 30 mm
- for all types of dowel connections
- content:
 - 1 wood dowel joiner 2 pcs.
 - 1 dowel drill, ø 8 mm
 - 1 depth stop, ø 8 mm
 - 40 wood dowels, ø 8 mm
- packaging: double blister
- separate accessories: 2730000, 2731000, 2732000, 2733000, 2905000, 2906000, 2907000, 2908000, 2909000, 2910000, 7150000, 7151000, 7152000



article no.	EAN	description
3750000	4006885... ...375000	1 universal dowelling set

Wood dowels



- according to DIN 68150
- material: dried beech wood
- packaging: plastic bag on card
- suitable for 3750000, 4640000, 4650000



article no.	EAN	description	ø	for	length
2905000	...290501	200 dowel pins	ø 6 mm	for board thicknesses from 12 - 14 mm	30 mm
2906000	...290600	50 dowel pins	ø 6 mm	for board thicknesses from 12 - 14 mm	30 mm
2907000	...290709	150 dowel pins	ø 8 mm	for board thicknesses from 15 - 18 mm	40 mm
2908000	...290808	40 dowel pins	ø 8 mm	for board thicknesses from 15 - 18 mm	40 mm
2909000	...290907	120 dowel pins	ø 10 mm	for board thicknesses from 19 - 30 mm	40 mm
2910000	...291003	30 dowel pins	ø 10 mm	for board thicknesses from 19 - 30 mm	40 mm

WOOD JOINTS

5

5.1 Dowel connections



- easy and clean to use
- no additional glue required
- no bothersome glue residues
- according to DIN 68150
- version: pre-glued
- material: beech wood
- packaging: double card with inlaid blister
- suitable for 3750000, 4640000, 4650000

article no.	EAN 4006885...	description	Ø	for	length
7150000	...715004	30 dowel pins pre-glued	Ø 6 mm	for board thicknesses from 12 - 14 mm	30 mm
7151000	...715103	30 dowel pins pre-glued	Ø 8 mm	for board thicknesses from 15 - 18 mm	40 mm
7152000	...715202	30 dowel pins pre-glued	Ø 10 mm	for board thicknesses from 19 - 30 mm	40 mm

Dowel drills



- for wood, plywood, chipboards, fibre boards
- drill with precision-ground rough cutter and centering tip
- high durability
- depth of cut set by depth stop
- fixed easily and safely on the drill
- material: chromium-vanadium steel
- including: 1 depth stop zinc die-cast
- packaging: blister on card
- suitable for 3750000, 4640000, 4650000

article no.	EAN 4006885...	description	Ø
2731000	...273108	1 dowel drill	Ø 6 mm
2732000	...273207	1 dowel drill	Ø 8 mm
2733000	...273306	1 dowel drill	Ø 10 mm



- for wood, plywood, chipboards, fibre boards
- version: with centre point
- material: chromium-vanadium steel
- including: 3 depth stops, Ø 6, 8, 10 mm
- packaging: double card with inlaid blister
- suitable for 3750000, 4640000, 4650000

article no.	EAN 4006885...	description	Ø
2730000	...273009	3 dowel drills	Ø 6, 8, 10 mm

5 WOOD JOINTS

5.1 Dowel connections

Depth stops



- for all wood twist drills with Ø 6, 8, 10 mm
- packaging: blister on card

article no.	EAN	description	Ø
2751000	4006885... ...275102	3 depth stops	Ø 6, 8, 10 mm



- for all drills with Ø 6, 8, 10 mm
- precise setting of the borehole depth
- fixed easily and safely on the drill
- no tilting on the drill thanks to the new design
- material: zinc die-cast
- including: 1 hexagonal key
- packaging: blister on card

article no.	EAN	description	Ø
2755000	4006885... ...275508	3 depth stops	Ø 6, 8, 10 mm

Centre points



- for exact marking of dowel holes
- packaging: blister on card

article no.	EAN	description	Ø	for
2911000	4006885... ...291102	4 centre points	Ø 6 mm	for board thicknesses from 12 - 14 mm
2912000	...291201	4 centre points	Ø 8 mm	for board thicknesses from 15 - 18 mm
2913000	...291300	4 centre points	Ø 10 mm	for board thicknesses from 19 - 30 mm

WOOD JOINTS 5

5.1 Dowel connections

Assortments



The complete starter set

- for 6, 8 and 10 mm dowel pins
- for all common wood/ dowel connections, such as exact and stable corners, T-butts and surface-to-surface connections
- content:
 - 1 dowelmaster
 - 26 wood dowels, ø 6 mm
 - 22 wood dowels, ø 8 mm
 - 16 wood dowels, ø 10 mm
 - 3 wood drills, ø 6, 8, 10 mm
 - 6 centre points, each 2 pcs. ø 6, 8, 10 mm
 - 3 depth stops, ø 6, 8, 10 mm
 - 1 wood glue, 20 ml
- in plastic case
- packaging: sticker



article no.	EAN	description
4645000	4006885... ...464506	1 universal dowel kit



- for making dowel joints
- for exact marking of dowel holes
- for wood, plywood, chipboards, fibre boards
- drill with precision-ground rough cutter and centering tip
- depth of cut set by depth stop
- packaging: double card with inlaid blister



article no.	EAN	description	content
2916000	4006885... ...291607	1 dowel kit	4 centre points, ø 6 mm 1 dowel drill, ø 6 mm 1 depth stop, ø 6 mm 25 dowel pins, ø 6 mm
2917000	4006885... ...291706	1 dowel kit	4 centre points, ø 8 mm 1 dowel drill, ø 8 mm 1 depth stop, ø 8 mm 22 dowel pins, ø 8 mm

5 WOOD JOINTS

5.1 Dowel connections



article no.	EAN	description	content
2918000	4006885... ...291805	1 dowel kit	4 centre points, ø 10 mm 1 dowel drill, ø 10 mm 1 depth stop, ø 10 mm 19 dowel pins, ø 10 mm

5.3 Biscuit joints

Biscuit jointers



cutting of shadow joints

The allrounder for wood processing

Suitable for all types of one-hand angle grinders with M14 spindle thread and tapped bores for grab handles on either side (M6, M8, M10).

- wood joints with jointing biscuits
- cutting of shadow joints
- mitre cuts
- milling of battens
- including:
 - 1 groove saw TCT, ø 100 mm
 - 1 chip collection bag
- packaging: covering box
- separate accessories: 2921000, 2922000, 2923000, 2924000, 2949000, 7153000, 7154000, 7155000



article no.	EAN	description	product dimensions	weight
2920000	4006885... ...292000	1 multi-wood jointer	135 x 140 x 400 mm	1.15 kg

WOOD JOINTS

5.3 Biscuit joints

5

Jointing biscuits



- material: beech wood, compressed under high pressure
- packaging: plastic bag on card
- suitable for 2920000



article no.	EAN 4006885...	description	size	for	product dimensions
2921000	...292109	50 jointing biscuits	No. 0	for board thicknesses from 10 - 12 mm	45 x 15 x 4 mm
2949000	...294905	150 jointing biscuits	No. 10	for board thicknesses from 13 - 15 mm	55 x 19 x 4 mm
2922000	...292208	50 jointing biscuits	No. 10	for board thicknesses from 13 - 15 mm	55 x 19 x 4 mm
2923000	...292307	50 jointing biscuits	No. 20	for board thicknesses ≥ 16 mm	61 x 23 x 4 mm



- easy and clean to use
- no additional glue required
- no bothersome glue residues
- version: pre-glued
- material: beech wood, compressed under high pressure
- packaging: double card with inlaid blister
- suitable for 2920000



article no.	EAN 4006885...	description	size	for	product dimensions
7153000	...715301	20 jointing biscuits pre-glued	No. 0	for board thicknesses from 10 - 12 mm	45 x 15 x 4 mm
7154000	...715400	20 jointing biscuits pre-glued	No. 10	for board thicknesses from 13 - 15 mm	55 x 19 x 4 mm
7155000	...715509	20 jointing biscuits pre-glued	No. 20	for board thicknesses ≥ 16 mm	61 x 23 x 4 mm

Replacement groove saws



- for all types of wood, chipboards
- material: tungsten carbide tipped
- packaging: paperboard card
- suitable for 2920000

article no.	EAN 4006885...	description	Ø	bore
2924000	...292406	1 replacement groove saw	Ø 100 mm	Ø 22.2 mm

5 WOOD JOINTS

5.4 Screw joints

Concealed screwed connection



With the "Undercover Jig", you drill precise holes in the workpiece...



...then you join the two workpieces with wood screws...



...and here are your precise and stable joints!



including screw-hole covers to conceal the drill holes



In 3 simple steps you can connect your workpieces fast, precisely and stable. You can drill accurate boreholes into the work piece with the Undercover Jig, join the two work pieces thereafter and just have a precise and stable connection.



- corner connections
- T-butt connections
- edge-to-edge connections
- mitre connections
- measuring the board thickness with a built-in ruler
- pre-adjustment for all standard board thicknesses (min. 12 mm)
- content:
 - 1 Undercover Jig
 - 1 step drill, HSS, \varnothing 9.5 mm, 180 mm
 - 1 depth stop, \varnothing 9.5 mm
 - 1 hexagonal key, SW 3
 - 1 screwdriver blade, 150 mm
 - 10 screw-hole covers, dried beech wood
 - 10 wood screws, 4 x 25 mm
 - 10 wood screws, 4 x 30 mm
 - 10 wood screws, 4 x 40 mm
 - 10 wood screws, 4 x 60 mm
- in plastic case
- packaging: sticker
- separate accessories: 2928000, 2933000, 2939000

article no.	EAN	description	version
4642000	4006885...464209	1 Undercover Jig set PZ	with Pozidriv PZ 2 screwdriver blade
4642100	4006885...464216	1 Undercover Jig set TX	with Torx TX 20 screwdriver blade

WOOD JOINTS 5

5.4 Screw joints

Accessories



- material: dried beech wood
- packaging: blister on card
- suitable for 4642000, 4642100



article no.	EAN	description	∅	length
2928000	4006885...292802	12 screw-hole covers	∅ 9.3 mm	46 mm



- material: HSS
- including: 1 depth stop
- packaging: plastic bag with inlay
- suitable for 4642000, 4642100

article no.	EAN	description	∅	length
2933000	4006885...293304	1 step drill	∅ 9.5 mm	180 mm



- material: beech
- packaging: plastic bag on card
- suitable for 4642000, 4642100



article no.	EAN	description	∅	length
2939000	4006885...293908	30 dowel pins	∅ 9.5 mm	40 mm

5.5 Wooden parts



- to cover screw heads
- to close knot holes
- material: pine wood
- packaging: plastic bag on card



article no.	EAN	description	∅
2940000	4006885...294004	50 wooden plugs	∅ 15 mm
2941000	4006885...294103	40 wooden plugs	∅ 20 mm
2942000	4006885...294202	20 wooden plugs	∅ 25 mm
2943000	4006885...294301	10 wooden plugs	∅ 30 mm
2944000	4006885...294400	10 wooden plugs	∅ 35 mm
2945000	4006885...294509	8 wooden plugs	∅ 40 mm

5 WOOD JOINTS

5.98 Miscellaneous



- fast and precise shortening at a 45° and 90° angle
- material: aluminium
- including: 1 clamp
- packaging: sleeve

article no.	EAN	description	product dimensions
2228000	4006885... ...222809	1 mitre box	250 x 60 x 73 mm

6.1 Jigsaw blades



6.1 Jigsaw blades

Jigsaw blades

suitable for AEG, Bosch, Casals, DeWalt, Eltos, Elu, Festool, Flex, Hitachi, Holz-Her, KANGO, KRAFTRONIC, Kress, MAFELL, Makita, Metabo, PERLES, Peugeot, Skil, Stayer

for wood/plastic working



- material: HCS
- tooth form: straight-set and ground
- tooth distance: 4 mm
- toothed length: 75 mm
- total length: 100 mm
- packaging: storage box on card



article no.	EAN	description	shank	cutting depth	quality of cut	for
3545000	...354500	2 jigsaw blades	T-shank	50 mm	rough curved cuts	soft wood, chipboards, wood core chipboards



- material: HCS
- tooth form: straight-set and ground
- tooth distance: 4 mm
- toothed length: 75 mm
- total length: 100 mm
- version: conical back
- packaging: storage box on card



article no.	EAN	description	shank	cutting depth	quality of cut	for
2382000	...238206	2 jigsaw blades	T-shank	45 mm	fast, rough cuts	soft wood, chipboards, wood core chipboards, MDF
2652000	...265202	5 jigsaw blades	T-shank	45 mm	fast, rough cuts	soft wood, chipboards, wood core chipboards, MDF



- material: HCS
- tooth form: straight-set and ground
- tooth distance: 2 - 3 mm
- toothed length: 93 mm
- total length: 116 mm
- version: conical back
- packaging: storage box on card



article no.	EAN	description	shank	cutting depth	quality of cut	for
3543000	...354302	2 jigsaw blades	T-shank	65 mm	quick, fine cuts	soft wood, chipboards, wood core chipboards, MDF, wooden beams

POWER TOOL ACCESSORIES

6.1 Jigsaw blades

6



- material: HCS
- tooth form: form-ground and milled
- tooth distance: 2 mm
- toothed length: 50 mm
- total length: 76 mm
- packaging: storage box on card

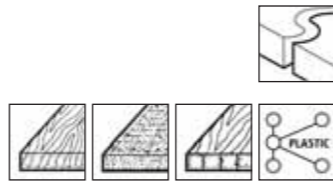

article no.	EAN	description	shank	cutting depth	quality of cut	for
2313000	...231306	2 jigsaw blades	T-shank	20 mm	clean curved cuts	soft wood, chipboards, wood core chipboards, plastic materials



- material: HCS
- tooth form: straight-set and milled
- tooth distance: 3 mm
- toothed length: 75 mm
- total length: 100 mm
- packaging: storage box on card

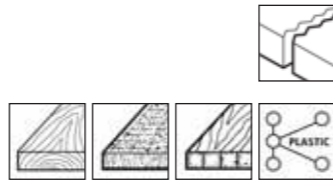

article no.	EAN	description	shank	cutting depth	quality of cut	for
2311000	...231108	2 jigsaw blades	T-shank	50 mm	fast, rough cuts	hardwood, chipboards, wood core chipboards, plastic materials
2361000	...236103	5 jigsaw blades	T-shank	50 mm	fast, rough cuts	hardwood, chipboards, wood core chipboards, plastic materials



- material: HCS
- tooth form: straight-set and ground
- tooth distance: 2,5 mm
- tooth version: opposed tooth position
- toothed length: 75 mm
- total length: 100 mm
- version: conical back
- used without a pendulum stroke
- packaging: storage box on card

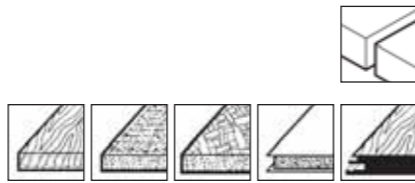

article no.	EAN	description	shank	cutting depth	quality of cut	for
3551000	...355101	2 jigsaw blades	T-shank	30 mm	fine, clean cuts	soft wood, chipboards, MDF, plastic coated chipboards, laminate
2653000	...265301	5 jigsaw blades	T-shank	30 mm	fine, clean cuts	soft wood, chipboards, MDF, plastic coated chipboards, laminate

6 POWER TOOL ACCESSORIES

6.1 Jigsaw blades



- material: HCS
- tooth form: straight-set and ground
- tooth distance: 2,5 mm
- toothed length: 75 mm
- total length: 100 mm
- version: conical back
- packaging: storage box on card

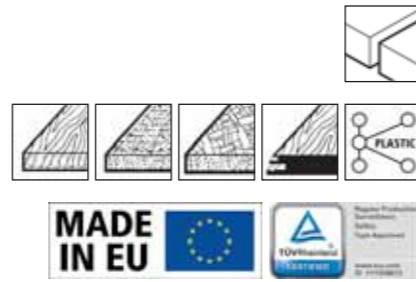

article no.	EAN	description	shank	cutting depth	quality of cut	for
2381000	...238107	2 jigsaw blades	T-shank	30 mm	clean cuts	soft wood, chipboards, MDF, laminate, plastic materials
2651000	...265103	5 jigsaw blades	T-shank	30 mm	clean cuts	soft wood, chipboards, MDF, laminate, plastic materials



- material: HCS
- tooth form: straight-set and milled
- tooth distance: 4 mm
- toothed length: 75 mm
- total length: 100 mm
- packaging: storage box on card



article no.	EAN	description	shank	cutting depth	quality of cut	for
2310000	...231009	2 jigsaw blades	T-shank	50 mm	fast, very rough cuts	hardwood, plywood, wooden beams
2360000	...236004	5 jigsaw blades	T-shank	50 mm	fast, very rough cuts	hardwood, plywood, wooden beams



- special blade for narrow curves
- material: HCS
- tooth form: straight-set and ground
- tooth distance: 2,5 mm
- tooth version: back toothed
- toothed length: 75, 40 mm
- total length: 100 mm
- version: conical back
- packaging: storage box on card

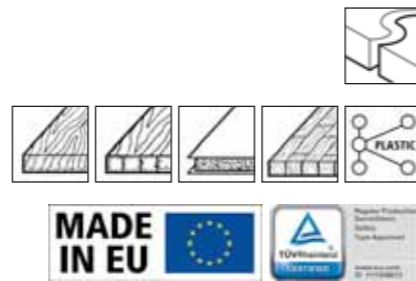

article no.	EAN	description	shank	cutting depth	quality of cut	for
3546000	...354609	2 jigsaw blades	T-shank	30 mm	clean curved cuts	soft wood, wood core chipboards, plastic coated chipboards, plastic material, parquet

POWER TOOL ACCESSORIES

6.1 Jigsaw blades

6



- special blade for the smallest radii
- ideal for cutting out special shapes
- toothing on both sides enables splinter-free curved cuts in both directions.
- material: HCS
- tooth form: straight-set and ground
- tooth distance: 2,2 / 3,2 mm
- tooth version: vario-toothing
- toothed length: 85, 59 mm
- total length: 115 mm
- version: conical back
- packaging: storage box on card

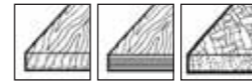

article no.	EAN	description	shank	cutting depth	quality of cut	for
2682000	4006885... ...268203	2 jigsaw blades	T-shank	40 mm	clean curved cuts	soft wood, plywood, MDF



- material: HCS
- tooth form: straight-set and ground
- tooth distance: 4 mm
- toothed length: 75 mm
- total length: 100 mm
- packaging: storage box on card

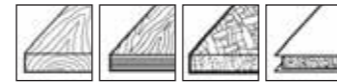

article no.	EAN	description	shank	cutting depth	quality of cut	for
2380000	4006885... ...238008	2 jigsaw blades	T-shank	50 mm	fast, rough cuts	hardwood, plywood, MDF, plastic coated chipboards
2650000	...265004	5 jigsaw blades	T-shank	50 mm	fast, rough cuts	hardwood, plywood, MDF, plastic coated chipboards



- material: HCS
- tooth form: straight-set and ground
- tooth distance: 1,35 mm
- toothed length: 50 mm
- total length: 75 mm
- version: conical back
- packaging: storage box on card



article no.	EAN	description	shank	cutting depth	quality of cut	for
2383000	4006885... ...238305	2 jigsaw blades	T-shank	20 mm	clean curved cuts	plywood, wood core chipboards, plastic coated chipboards, laminate, parquet
2393000	...239302	5 jigsaw blades	T-shank	20 mm	clean curved cuts	plywood, wood core chipboards, plastic coated chipboards, laminate, parquet

6 POWER TOOL ACCESSORIES

6.1 Jigsaw blades

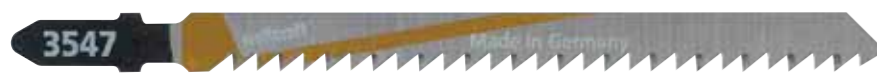

- material: HCS
- tooth form: straight-set and ground
- tooth distance: 3 mm
- toothed length: 90 mm
- total length: 115 mm
- version: conical back
- packaging: storage box on card

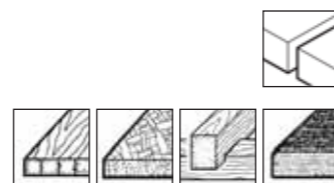

article no.	EAN	description	shank	cutting depth	quality of cut	for
3547000	...354708	2 jigsaw blades	T-shank	65 mm	quick, fine cuts	wood core chipboards, MDF, wooden beams, kitchen worktops



- thanks to the specific tooth geometry very clean cuts on the top and bottom side of the workpiece
- material: HCS
- version: conical back
- tooth form: straight-set and ground
- tooth distance: 1,65 mm
- toothed length: 75 mm
- total length: 100 mm
- packaging: storage box on card

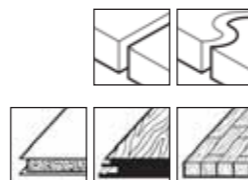

article no.	EAN	description	shank	cutting depth	quality of cut	for
2379000	...237902	3 jigsaw blades	T-shank	25 mm	clean, straight cuts	plastic coated chipboards, laminate, parquet
				25 mm	clean curved cuts	plastic coated chipboards, laminate, parquet



- material: CV
- tooth form: straight-set and milled
- tooth distance: 4 mm
- toothed length: 227 mm
- total length: 250 mm
- packaging: plastic bag with inlay

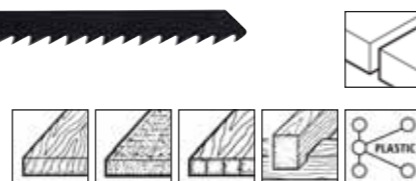

article no.	EAN	description	shank	cutting depth	quality of cut	for
2692000	...269200	1 jigsaw blade	T-shank	200 mm	fine cuts	wooden beams, soft wood, chipboards, wood core chipboards, plastic materials

POWER TOOL ACCESSORIES 6

6.1 Jigsaw blades



- optimal cooling thanks to symmetrical recesses
- high durability
- material: CV
- tooth form: straight-set and ground
- tooth distance: 2,5 mm
- toothed length: 75 mm
- total length: 100 mm
- version: conical back
- packaging: storage box on card



article no.	EAN	description	shank	cutting depth	quality of cut	for
2680000	4006885... ...268005	2 jigsaw blades	T-shank	30 mm	fine, precise cuts	soft wood, plywood, plastic material



- material: HSS
- tooth form: straight-set and ground
- tooth distance: 2,5 mm
- toothed length: 75 mm
- total length: 100 mm
- version: conical back
- packaging: storage box on card

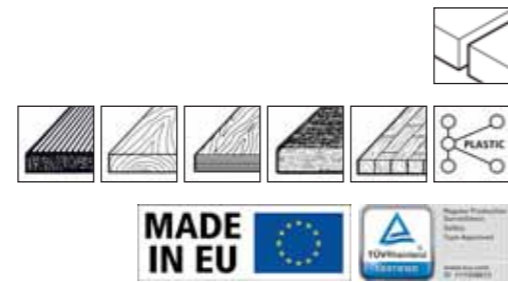

article no.	EAN	description	shank	cutting depth	quality of cut	for
2315000	4006885... ...231504	2 jigsaw blades	T-shank	40 mm	fine, clean cuts	terrace wood, plywood, kitchen worktops, parquet, plastic materials
2365000	...236509	5 jigsaw blades	T-shank	40 mm	fine, clean cuts	terrace wood, plywood, kitchen worktops, parquet, plastic materials



- material: BiM
- tooth form: straight-set and ground
- tooth distance: 2,5 mm
- toothed length: 75 mm
- total length: 100 mm
- version: conical back
- packaging: storage box on card

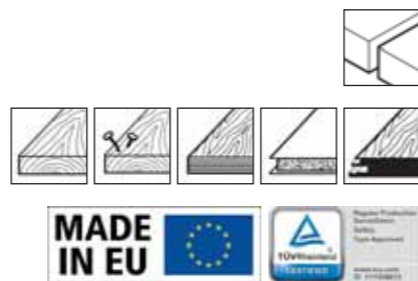

article no.	EAN	description	shank	cutting depth	quality of cut	for
2385000	4006885... ...238503	2 jigsaw blades	T-shank	30 mm	fine, clean cuts	hardwood, wood with nails, plywood, plastic coated chipboards, laminate

6 POWER TOOL ACCESSORIES

6.1 Jigsaw blades



- material: BiM
- tooth form: straight-set and ground
- tooth distance: 1,65 mm
- tooth version: pointed teeth
- toothed length: 75 mm
- total length: 100 mm
- version: conical back
- packaging: storage box on card



article no.	EAN	description	shank	cutting depth	quality of cut	for
3561000	4006885... ...356108	2 jigsaw blades	T-shank	30 mm	clean, fine cuts on both sides of the material	plastic coated chipboards, laminate, plastic materials, MDF, parquet



- packaging: storage box on card

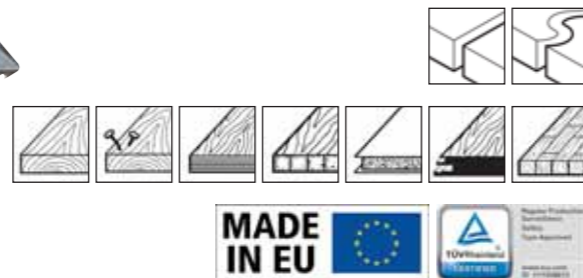

article no.	EAN	description	shank	cutting depth	quality of cut	for
2383100	4006885... ...238312	5 jigsaw blades	T-shank	20	clean curved cuts	laminate, plastic coated chipboards, plywood, parquet, wood core chipboards
				30	fine, clean cuts	laminate, plastic coated chipboards, wood with nails, plywood, hardwood



- material: HCS
- tooth form: straight-set and milled
- tooth distance: 3 mm
- toothed length: 75 mm
- total length: 100 mm
- packaging: plastic bag with inlay



article no.	EAN	description	shank	cutting depth	quality of cut	for
8431000	4006885... ...843103	2 jigsaw blades	T-shank	40 mm	rough cuts	soft wood

POWER TOOL ACCESSORIES 6

6.1 Jigsaw blades



- material: HCS
- tooth form: form-ground and milled
- tooth distance: 2 mm
- toothed length: 49 mm
- total length: 76 mm
- packaging: plastic bag with inlay

article no.	EAN	description	shank	cutting depth	quality of cut	for
8432000	4006885... ...843202	2 jigsaw blades	T-shank	15 mm	curved cuts	soft wood



- material: HCS
- tooth form: straight-set and milled
- tooth distance: 2,5 mm
- toothed length: 74 mm
- total length: 100 mm
- packaging: plastic bag with inlay

article no.	EAN	description	shank	cutting depth	quality of cut	for
8433000	4006885... ...843301	2 jigsaw blades	T-shank	30 mm	fine cuts	soft wood

for metal working



- material: HSS
- tooth form: form-ground and milled
- tooth distance: 1,2 mm
- toothed length: 50 mm
- total length: 75 mm
- packaging: storage box on card

article no.	EAN	description	shank	cutting depth	quality of cut	for
2318000	4006885... ...231801	2 jigsaw blades	T-shank	1 - 3 mm	fine cuts	sheet steel, non-ferrous metals
2654000	...265400	5 jigsaw blades	T-shank	1 - 3 mm	fine cuts	sheet steel, non-ferrous metals

6 POWER TOOL ACCESSORIES

6.1 Jigsaw blades



- material: HSS
- tooth form: form-ground and milled
- tooth distance: 1,2 mm
- toothed length: 110 mm
- total length: 130 mm
- packaging: storage box on card

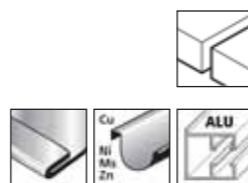

article no.	EAN	description	shank	cutting depth	quality of cut	for
3549000	...354906	2 jigsaw blades	T-shank	1 - 3 mm	fine cuts	sheet steel, non-ferrous metals, aluminium



- material: HSS
- tooth form: form-ground and milled
- tooth distance: 2 mm
- toothed length: 50 mm
- total length: 75 mm
- packaging: storage box on card

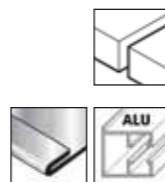

article no.	EAN	description	shank	cutting depth	quality of cut	for
2317000	...231702	2 jigsaw blades	T-shank	3 - 6 mm	fine cuts	sheet steel, aluminium
2367000	...236707	5 jigsaw blades	T-shank	3 - 6 mm	fine cuts	sheet steel, aluminium



- heavy-duty saw blade
- material: BiM
- tooth form: form-ground and milled
- tooth distance: 1,2 mm
- toothed length: 50 mm
- total length: 75 mm
- packaging: storage box on card

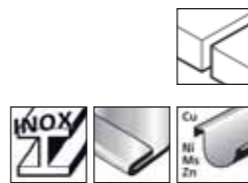

article no.	EAN	description	shank	cutting depth	quality of cut	for
2388000	...238800	2 jigsaw blades	T-shank	1 - 3 mm	fine cuts	sheet steel, non-ferrous metals, Inox



- material: HSS
- tooth form: form-ground and milled
- tooth distance: 2 mm
- toothed length: 50 mm
- total length: 75 mm
- packaging: plastic bag with inlay

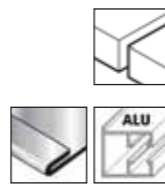

article no.	EAN	description	shank	cutting depth	quality of cut	for
8434000	...843400	2 jigsaw blades	T-shank	2,5 - 4 mm	fine cuts	non-ferrous metals, aluminium

POWER TOOL ACCESSORIES 6

6.1 Jigsaw blades

Universal blades



- material: BiM
- tooth form: straight-set and milled
- tooth distance: 1,8 mm, 2,5 mm
- tooth version: vario-toothing
- toothed length: 110 mm
- total length: 130 mm
- packaging: storage box on card

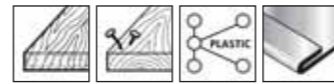

article no.	EAN	description	shank	cutting depth	quality of cut	for
3554000	4006885... ...355408	2 jigsaw blades	T-shank	65 mm 3 - 6 mm	rough cuts rough cuts	soft wood, wood with nails, plastic materials sheet steel



- material: BiM
- tooth form: straight-set and milled
- tooth distance: 2 mm, 4 mm
- toothed length: 110 mm
- total length: 130 mm
- packaging: storage box on card



article no.	EAN	description	shank	cutting depth	quality of cut	for
3555000	4006885... ...355507	2 jigsaw blades	T-shank	65 mm 3 - 10 mm	fast, rough cuts fast, rough cuts	hardwood, wood with nails, wooden beams, plastic materials non-ferrous metals



- material: BiM
- tooth form: straight-set and milled
- tooth distance: 1,2 mm
- toothed length: 227 mm
- total length: 250 mm
- packaging: plastic bag with inlay



article no.	EAN	description	shank	cutting depth	quality of cut	for
2691000	4006885... ...269101	1 jigsaw blade	T-shank	2 - 200 mm 1,5 - 3 mm	fine cuts fine cuts	sandwich materials sheet steel, aluminium, plastic materials

6.1 Jigsaw blades

Special jigsaw blades



- material: tungsten carbide tipped
- tooth distance: 4,3 mm
- toothed length: 105 mm
- total length: 132 mm
- packaging: storage box on card

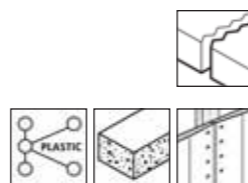

article no.	EAN	description	shank	cutting depth	quality of cut	for
2384000	4006885...238404	1 jigsaw blade	T-shank	80 mm	fast, rough cuts	plastic materials, aerated concrete, gypsum plaster boards



- material: tungsten carbide coated
- toothed length: 51 mm
- total length: 76 mm
- packaging: storage box on card



article no.	EAN	description	shank	cutting depth	quality of cut	for
2319000	4006885...231900	1 jigsaw blade	T-shank	15 mm	rough cuts	tiles

Assortments



- for virtually all work with the jigsaw
- content: 3 jigsaw blades
- packaging: storage box on card

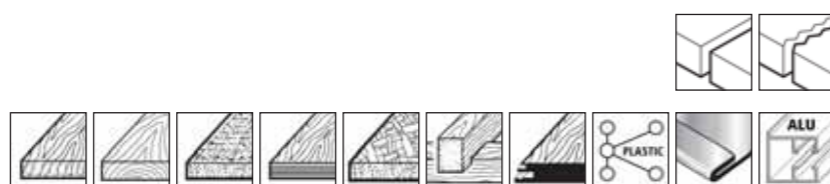

article no.	EAN	description	shank	material	cutting depth	quality of cut	for
2685000	4006885...268500	1 jigsaw blade starter set	T-shank	HCS	50 mm	fast, very rough cuts	hardwood, plywood, wooden beams
				HCS	30 mm	clean cuts	soft wood, chipboards, MDF, laminate, plastic materials
				HSS	3 - 6 mm	fine cuts	sheet steel, aluminium

POWER TOOL ACCESSORIES

6.1 Jigsaw blades

6



- ideal for all sawing work for the construction and conversion of kitchens
- content: 3 jigsaw blades
- packaging: storage box on card



article no.	EAN	description	shank	material	cutting depth	quality of cut	for
2684000	4006885... ...268401	1 jigsaw blade project set for kitchens	T-shank	HCS	30 mm	clean cuts	soft wood, chipboards, MDF, laminate, plastic materials
				HCS	50 mm	rough curved cuts	soft wood, chipboards, wood core chipboards
				HCS	65 mm	quick, fine cuts	wood core chipboards, MDF, wooden beams, kitchen worktops



- for all interior sawing work
- content: 5 jigsaw blades
- packaging: storage box on card



article no.	EAN	description	shank	material	cutting depth	quality of cut	for
2688000	4006885... ...268807	1 jigsaw blade project set for interior work	T-shank	HCS	50 mm	fast, rough cuts	hardwood, chipboards, wood core chipboards, plastic materials
				HCS	20 mm	clean curved cuts	soft wood, chipboards, wood core chipboards, plastic materials
				HSS	1 - 3 mm	fine cuts	sheet steel, non-ferrous metals
				tungsten carbide coated	15 mm	rough cuts	tiles
				BiM	30 mm	fine, clean cuts	hardwood, wood with nails, plywood, plastic coated chipboards, laminate

6 POWER TOOL ACCESSORIES

6.1 Jigsaw blades



The starter box for all do-it-yourselfers

- comfortable removal of individual blades at the push of the button
- free view of the blades thanks to a highly transparent plastic cover
- content: 10 jigsaw blades
- in storage box
- packaging: double blister on card

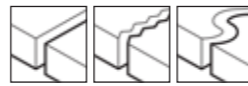
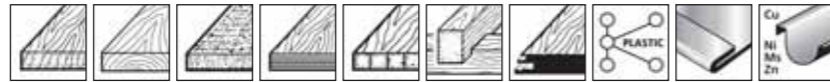

article no.	EAN	description	shank	material	cutting depth	quality of cut	for
3559000	...355903	1 jigsaw blade box	T-shank	HCS	50 mm	very rough cuts	hardwood, plywood, wooden beams
				HCS	50 mm	fast, rough cuts	hardwood, chipboards, plastic materials
				HCS	20 mm	clean curved cuts	soft wood, wood core chipboards, plastic materials
				HCS	30 mm	fine cuts	soft wood, chipboards, laminate
				HSS	1 - 3 mm	fine cuts	sheet steel, non-ferrous metals



- in plastic cassette
- packaging: sticker

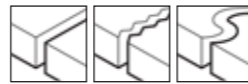

article no.	EAN	description	shank	material	cutting depth	quality of cut	for
2358000	...235809	10 jigsaw blades	T-shank	HCS	50 mm	very rough cuts	hardwood, plywood, wooden beams
				HCS	50 mm	fast, rough cuts	hardwood, chipboards, plastic materials
				HCS	20 mm	clean curved cuts	soft wood, chipboards, plastic materials
				HCS	30 mm	fine cuts	laminate, chipboards, plastic materials
				HSS	3 - 6 mm	fine cuts	sheet steel, aluminium
				HSS	1 - 3 mm	fine cuts	sheet steel, non-ferrous metals

POWER TOOL ACCESSORIES 6

6.1 Jigsaw blades



- in plastic cassette
- packaging: sticker

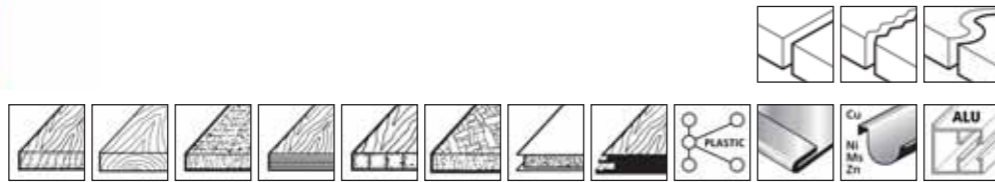

article no.	EAN	description	shank	material	cutting depth	quality of cut	for
2655000	4006885... ...265509	10 jigsaw blades	T-shank	HCS	20 mm	clean curved cuts	soft wood, chipboards, wood core chipboards, plastic materials
				HCS	50 mm	fast, rough cuts	hardwood, plywood, MDF, plastic coated chipboards
				HCS	30 mm	clean cuts	soft wood, chipboards, MDF, laminate, plastic materials
				HSS	3 - 6 mm	fine cuts	sheet steel, aluminium
				HSS	1 - 3 mm	fine cuts	sheet steel, non-ferrous metals



- inclusive (gratis) 1 pocket knife
- in 2-component plastic box with lid

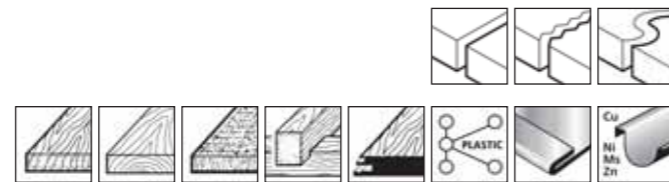

article no.	EAN	description	shank	material	cutting depth	quality of cut	for
2377000	4006885... ...237704	11 jigsaw blades + 1 pocket knife	T-shank	HCS	80	fast, rough cuts	wooden beams, hard and soft wood
				HCS	40	medium-coarse cuts	soft wood, chipboards, plastic material
				HCS	30	fine cuts	soft wood, chipboards, laminate
				HCS	25	fine cuts	laminate
				HCS	15	curved cuts	soft wood, chipboards
				HSS	1 - 3	fine cuts	sheet steel, non-ferrous metals

6 POWER TOOL ACCESSORIES

6.1 Jigsaw blades



- packaging: plastic bag on card



article no.	EAN	description	shank	cutting depth	quality of cut	for
8430000	4006885... ...843004	10 jigsaw blades	T-shank	15 mm	curved cuts	soft wood
				30 mm	fine cuts	soft wood
				40 mm	rough cuts	soft wood
				50 mm	very rough cuts	soft wood



- content: 10 jigsaw blades
- in 2-component plastic box with lid

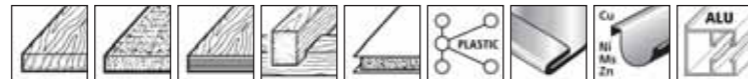

article no.	EAN	description	shank	material	cutting depth	quality of cut	for
8630000	4006885... ...863002	1 jigsaw blade box	T-shank	HCS	65 mm	very rough cuts	soft wood, plywood, wooden beams
				HCS	50 mm	fast, rough cuts	soft wood, chipboards, plastic materials
				HCS	20 mm	clean curved cuts	soft wood, chipboards, plastic materials
				HCS	30 mm	fine cuts	soft wood, plastic coated chipboards, plastic materials
				HSS	2,5 - 4 mm	fine cuts	non-ferrous metals, aluminium
				HSS	1 - 3 mm	fine cuts	sheet steel, non-ferrous metals

POWER TOOL ACCESSORIES 6

6.1 Jigsaw blades

Jigsaw blades

suitable for Black & Decker, Einhell, HAAGER, KRAFTRONIC, RYOBI, Skil, Stayer

for wood/plastic working



- material: HCS
- tooth form: straight-set and ground
- tooth distance: 4 mm
- toothed length: 75 mm
- total length: 100 mm
- packaging: storage box on card

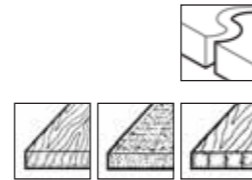

article no.	EAN	description	shank	cutting depth	quality of cut	for
3550000	...355002	2 jigsaw blades	U-shank	50 mm	rough curved cuts	soft wood, chipboards, wood core chipboards



- material: HCS
- tooth form: straight-set and ground
- tooth distance: 4 mm
- toothed length: 81 mm
- total length: 100 mm
- version: conical back
- packaging: storage box on card

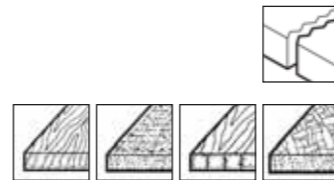

article no.	EAN	description	shank	cutting depth	quality of cut	for
2372000	...237209	2 jigsaw blades	U-shank	45 mm	fast, rough cuts	soft wood, chipboards, wood core chipboards, MDF



- material: HCS
- tooth form: straight-set and ground
- tooth distance: 2 - 3 mm
- toothed length: 93 mm
- total length: 116 mm
- version: conical back
- packaging: storage box on card

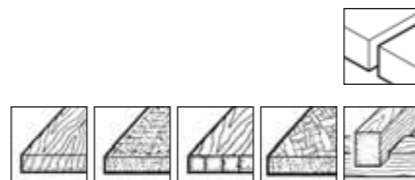

article no.	EAN	description	shank	cutting depth	quality of cut	for
3548000	...354807	2 jigsaw blades	U-shank	65 mm	quick, fine cuts	soft wood, chipboards, wood core chipboards, MDF, wooden beams

6 POWER TOOL ACCESSORIES

6.1 Jigsaw blades



- material: HCS
- tooth form: form-ground and milled
- tooth distance: 2 mm
- toothed length: 50 mm
- total length: 70 mm
- packaging: storage box on card

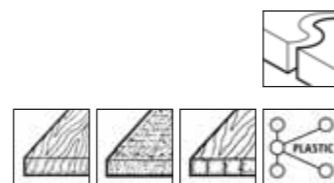

article no.	EAN	description	shank	cutting depth	quality of cut	for
2303000	4006885...230309	2 jigsaw blades	U-shank	20 mm	clean curved cuts	soft wood, chipboards, wood core chipboards, plastic materials



- material: HCS
- tooth form: straight-set and milled
- tooth distance: 3 mm
- toothed length: 75 mm
- total length: 100 mm
- packaging: storage box on card

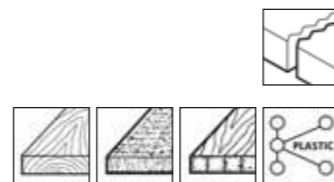

article no.	EAN	description	shank	cutting depth	quality of cut	for
2301000	4006885...230101	2 jigsaw blades	U-shank	50 mm	rough cuts	hardwood, chipboards, wood core chipboards, plastic materials
2351000	...235106	5 jigsaw blades	U-shank	50 mm	rough cuts	hardwood, chipboards, wood core chipboards, plastic materials

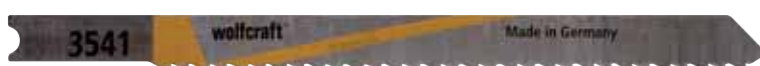

- material: HCS
- tooth form: straight-set and ground
- tooth distance: 2 mm
- tooth version: opposed tooth position
- toothed length: 75 mm
- total length: 100 mm
- version: conical back
- used without a pendulum stroke
- packaging: storage box on card



article no.	EAN	description	shank	cutting depth	quality of cut	for
3541000	4006885...354104	2 jigsaw blades	U-shank	30 mm	fine, clean cuts	soft wood, chipboards, MDF, plastic coated chipboards, laminate

POWER TOOL ACCESSORIES 6

6.1 Jigsaw blades

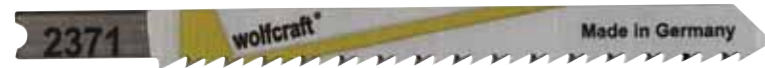

- material: HCS
- tooth form: straight-set and ground
- tooth distance: 2,5 mm
- toothed length: 81 mm
- total length: 100 mm
- version: conical back
- packaging: storage box on card



article no.	EAN	description	shank	cutting depth	quality of cut	for
2371000	4006885... ...237100	2 jigsaw blades	U-shank	30 mm	clean cuts	soft wood, chipboards, MDF, laminate, plastic materials



- material: HCS
- tooth form: straight-set and ground
- tooth distance: 4 mm
- toothed length: 61 mm
- total length: 80 mm
- packaging: storage box on card



article no.	EAN	description	shank	cutting depth	quality of cut	for
2300000	4006885... ...230002	2 jigsaw blades	U-shank	35 mm	very rough cuts	hardwood, plywood, wooden beams



- special blade for the smallest radii
- ideal for cutting out special shapes
- toothing on both sides enables splinter-free curved cuts in both directions.
- material: HCS
- tooth distance: 2,2 / 3,2 mm
- tooth version: vario-toothing
- toothed length: 85, 59 mm
- total length: 115 mm
- version: conical back
- packaging: storage box on card

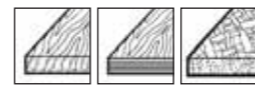

article no.	EAN	description	shank	cutting depth	quality of cut	for
2683000	4006885... ...268302	2 jigsaw blades	U-shank	40 mm	clean curved cuts	soft wood, plywood, MDF

6 POWER TOOL ACCESSORIES

6.1 Jigsaw blades



- material: HCS
- tooth form: straight-set and ground
- tooth distance: 4 mm
- toothed length: 81 mm
- total length: 100 mm
- packaging: storage box on card



article no.	EAN	description	shank	cutting depth	quality of cut	for
2370000	...237001	2 jigsaw blades	U-shank	50 mm	fast, rough cuts	hardwood, plywood, MDF, plastic coated chipboards



- material: HCS
- tooth form: straight-set and ground
- tooth distance: 2 mm
- toothed length: 61 mm
- total length: 80 mm
- version: conical back
- packaging: storage box on card



article no.	EAN	description	shank	cutting depth	quality of cut	for
2305000	...230507	2 jigsaw blades	U-shank	20 mm	fine, clean cuts	hardwood, plywood, parquet, plastic materials



- material: HCS
- tooth form: straight-set and ground
- tooth distance: 1,35 mm
- toothed length: 52 mm
- total length: 70 mm
- version: conical back
- packaging: storage box on card



article no.	EAN	description	shank	cutting depth	quality of cut	for
2373000	...237308	2 jigsaw blades	U-shank	20 mm	clean curved cuts	plywood, wood core chipboards, plastic coated chipboards, laminate, parquet

POWER TOOL ACCESSORIES 6

6.1 Jigsaw blades



- material: HCS
- tooth form: straight-set and ground
- tooth distance: 3 mm
- toothed length: 90 mm
- total length: 115 mm
- version: conical back
- packaging: storage box on card



article no.	EAN	description	shank	cutting depth	quality of cut	for
3537000	...353701	2 jigsaw blades	U-shank	65 mm	quick, fine cuts	wood core chipboards, MDF, wooden beams, kitchen worktops



- material: HCS
- version: conical back
- tooth form: straight-set and ground
- tooth distance: 1,65 mm
- toothed length: 75 mm
- total length: 100 mm
- packaging: storage box on card

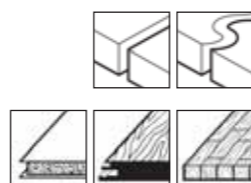

article no.	EAN	description	shank	cutting depth	quality of cut	for
2674000	...267404	3 jigsaw blades	U-shank	25 mm	clean, straight cuts	plastic coated chipboards, laminate, parquet
				25 mm	clean curved cuts	



- optimal cooling thanks to symmetrical recesses
- high durability
- material: CV
- tooth form: straight-set and ground
- tooth distance: 2,5 mm
- toothed length: 75 mm
- total length: 100 mm
- version: conical back
- packaging: storage box on card

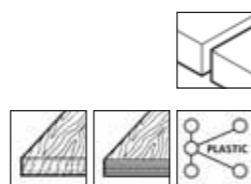

article no.	EAN	description	shank	cutting depth	quality of cut	for
2681000	...268104	2 jigsaw blades	U-shank	30 mm	fine, precise cuts	soft wood, plywood, plastic material

6 POWER TOOL ACCESSORIES

6.1 Jigsaw blades



- material: BiM
- tooth form: straight-set and ground
- tooth distance: 2,5 mm
- toothed length: 81 mm
- total length: 100 mm
- version: conical back
- packaging: storage box on card



article no.	EAN	description	shank	cutting depth	quality of cut	for
2375000	4006885...237506	2 jigsaw blades	U-shank	30 mm	fine, clean cuts	hardwood, wood with nails, plywood, plastic coated chipboards, laminate



- material: HCS
- tooth form: straight-set and milled
- tooth distance: 3 mm
- toothed length: 74 mm
- total length: 91.5 mm
- packaging: plastic bag with inlay



article no.	EAN	description	shank	cutting depth	quality of cut	for
8441000	4006885...844100	2 jigsaw blades	U-shank	40 mm	rough cuts	soft wood



- material: HCS
- tooth form: form-ground and milled
- tooth distance: 2 mm
- toothed length: 49 mm
- total length: 70 mm
- packaging: plastic bag with inlay



article no.	EAN	description	shank	cutting depth	quality of cut	for
8442000	4006885...844209	2 jigsaw blades	U-shank	15 mm	curved cuts	soft wood



- material: HCS
- tooth form: straight-set and milled
- tooth distance: 2,5 mm
- toothed length: 74 mm
- total length: 91.5 mm
- packaging: plastic bag with inlay



article no.	EAN	description	shank	cutting depth	quality of cut	for
8443000	4006885...844308	2 jigsaw blades	U-shank	30 mm	fine cuts	soft wood

POWER TOOL ACCESSORIES

6.1 Jigsaw blades

6

for metal working



- material: HSS
- tooth form: form-ground and milled
- tooth distance: 1,2 mm
- toothed length: 110 mm
- total length: 130 mm
- packaging: storage box on card

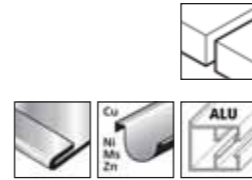

article no.	EAN	description	shank	cutting depth	quality of cut	for
3538000	4006885... ...353800	2 jigsaw blades	U-shank	1 - 3 mm	fine cuts	sheet steel, non-ferrous metals, aluminium



- material: HSS
- tooth form: form-ground and milled
- tooth distance: 1,2 mm
- toothed length: 52 mm
- total length: 70 mm
- packaging: storage box on card

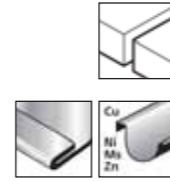

article no.	EAN	description	shank	cutting depth	quality of cut	for
2308000	4006885... ...230804	2 jigsaw blades	U-shank	1 - 3 mm	fine cuts	sheet steel, non-ferrous metals



- material: HSS
- tooth form: form-ground and milled
- tooth distance: 2 mm
- toothed length: 52 mm
- total length: 70 mm
- packaging: storage box on card

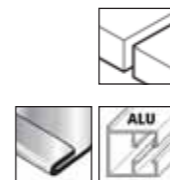

article no.	EAN	description	shank	cutting depth	quality of cut	for
2376000	4006885... ...237605	2 jigsaw blades	U-shank	3 - 6 mm	fine cuts	sheet steel, aluminium



- material: HSS
- tooth form: straight-set and milled
- tooth distance: 3 mm
- toothed length: 61 mm
- total length: 80 mm
- packaging: storage box on card



article no.	EAN	description	shank	cutting depth	quality of cut	for
2307000	4006885... ...230705	2 jigsaw blades	U-shank	3 - 10 mm	rough cuts	sheet steel, aluminium

6 POWER TOOL ACCESSORIES

6.1 Jigsaw blades



- heavy-duty saw blade
- material: BiM
- tooth form: form-ground and milled
- tooth distance: 1,2 mm
- toothed length: 52 mm
- total length: 70 mm
- packaging: storage box on card



article no.	EAN	description	shank	cutting depth	quality of cut	for
2378000	...237803	2 jigsaw blades	U-shank	1 - 3 mm	fine cuts	sheet steel, non-ferrous metals, Inox



- material: HSS
- tooth form: form-ground and milled
- tooth distance: 2 mm
- toothed length: 52 mm
- total length: 70 mm
- packaging: plastic bag with inlay

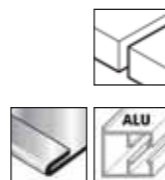

article no.	EAN	description	shank	cutting depth	quality of cut	for
8444000	...844407	2 jigsaw blades	U-shank	3 - 5 mm	fine cuts	sheet steel, aluminium

Universal blades



- material: BiM
- tooth form: straight-set and milled
- tooth distance: 1,8 mm, 2,5 mm
- tooth version: vario-toothing
- toothed length: 110 mm
- total length: 130 mm
- packaging: storage box on card

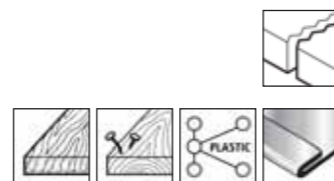

article no.	EAN	description	shank	cutting depth	quality of cut	for
3544000	...354401	2 jigsaw blades	U-shank	65 mm	rough cuts	soft wood, wood with nails, plastic materials
				3 - 6 mm	rough cuts	sheet steel

POWER TOOL ACCESSORIES 6

6.1 Jigsaw blades

Special jigsaw blades



- material: TCT
- tooth version: tungsten carbide coated
- toothed length: 51 mm
- total length: 70 mm
- packaging: storage box on card



article no.	EAN	description	shank	cutting depth	quality of cut	for
2309000	4006885... ...230903	1 jigsaw blade	U-shank	15 mm	rough cuts	tiles

Assortments



- for virtually all work with the jigsaw
- content: 3 jigsaw blades
- packaging: storage box on card



article no.	EAN	description	shank	material	cutting depth	quality of cut	for
2690000	4006885... ...269002	1 jigsaw blade starter set	U-shank	HCS	50 mm	rough cuts	hardwood, chipboards, wood core chipboards, plastic materials
				HCS	30 mm	clean cuts	soft wood, chipboards, MDF, laminate, plastic materials
				HSS	3 - 6 mm	fine cuts	sheet steel, aluminium

6 POWER TOOL ACCESSORIES

6.1 Jigsaw blades



- ideal for all sawing work for the construction and conversion of kitchens
- content: 3 jigsaw blades
- packaging: storage box on card



article no.	EAN	description	shank	material	cutting depth	quality of cut	for
2689000	4006885... ...268906	1 jigsaw blade project set for kitchens	U-shank	HCS	30 mm	clean cuts	soft wood, chipboards, MDF, laminate, plastic materials
				HCS	50 mm	rough curved cuts	soft wood, chipboards, wood core chipboards
				HCS	65 mm	quick, fine cuts	wood core chipboards, MDF, wooden beams, kitchen worktops



- in plastic cassette
- packaging: sticker



article no.	EAN	description	shank	material	cutting depth	quality of cut	for
2356000	4006885... ...235601	10 jigsaw blades	U-shank	HCS	35 mm	very rough cuts	hardwood, plywood, wooden beams
				HCS	50 mm	rough cuts	hardwood, chipboards, plastic materials
				HCS	20 mm	clean curved cuts	soft wood, chipboards, plastic materials
				HCS	20 mm	fine cuts	soft wood, hardwood, plastic materials, parquet
				HSS	3 - 10 mm	rough cuts	sheet steel, aluminium
				HSS	1 - 3 mm	fine cuts	sheet steel, non-ferrous metals

POWER TOOL ACCESSORIES 6

6.1 Jigsaw blades



- packaging: plastic bag on card

article no.	EAN	description	shank	cutting depth	quality of cut	for
8440000	4006885... ...844001	10 jigsaw blades	U-shank	15 mm	clean curved cuts	soft wood
				30 mm	fine cuts	soft wood
				40 mm	rough cuts	soft wood
				50 mm	very rough cuts	soft wood



- content: 10 jigsaw blades
- in 2-component plastic box with lid



article no.	EAN	description	shank	material	cutting depth	quality of cut	for
8631000	4006885... ...863101	1 jigsaw blade box	U-shank	HCS	50 mm	very rough cuts	soft wood, plywood, wooden beams
				HCS	50 mm	rough cuts	soft wood, chipboards, plastic materials
				HCS	20 mm	curved cuts	soft wood, chipboards, plastic materials
				HCS	30 mm	fine cuts	soft wood, plastic coated chipboards, plastic materials
				HSS	3 - 6 mm	fine cuts	sheet steel, non-ferrous metals, aluminium
				HSS	1 - 3 mm	fine cuts	sheet steel, non-ferrous metals

6 POWER TOOL ACCESSORIES

6.1 Jigsaw blades

Jigsaw blades

suitable for Peugeot

for wood/plastic working



- material: HCS
- tooth form: straight-set and ground
- tooth distance: 2,5 mm
- toothed length: 75 mm
- total length: 100 mm
- version: conical back
- packaging: storage box on card

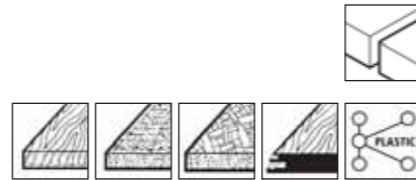

article no.	EAN	description	shank	cutting depth	quality of cut	for
2345000	4006885...234505	2 jigsaw blades	PG-shank	30 mm	clean cuts	soft wood, chipboards, MDF, laminate, plastic materials

Sabre saw blades for electric handsaw

suitable for AEG, Black & Decker, Bosch, Elu, Flex, Hitachi, KRAFTRONIC, Makita, Metabo, Rockwell, Skil

for wood/plastic working



- material: CV
- tooth form: straight-set and ground
- tooth distance: 4,2 mm
- toothed length: 130 mm
- total length: 150 mm
- used with a pendulum stroke
- packaging: plastic bag with inlay



article no.	EAN	description	cutting depth	quality of cut	for
2290000	4006885...229006	2 sabre saw blades	10 - 100 mm	quick, fine curved cuts	soft wood, wooden beams, plastic materials

POWER TOOL ACCESSORIES 6

6.1 Jigsaw blades

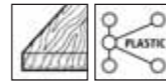

- material: CV
- tooth form: straight-set and milled
- tooth distance: 2,5 mm
- toothed length: 122 mm
- total length: 150 mm
- used with a pendulum stroke
- packaging: plastic bag with inlay

article no.	EAN	description	cutting depth	quality of cut	for
2294000	4006885... ...229402	2 sabre saw blades	10 - 100 mm	fine cuts	wood, plastic material



- material: CV
- tooth form: straight-set and ground
- tooth distance: 8,5 mm
- tooth version: extra sharp toothing
- toothed length: 218 mm
- total length: 240 mm
- used with a pendulum stroke
- packaging: plastic bag with inlay

article no.	EAN	description	cutting depth	quality of cut	for
2289000	4006885... ...228900	2 sabre saw blades	20 - 190 mm	fast, very rough cuts	soft wood, tree cutting

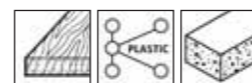

- material: CV
- tooth form: straight-set and milled
- tooth distance: 4,2 mm
- toothed length: 280 mm
- total length: 300 mm
- packaging: plastic bag with inlay

article no.	EAN	description	cutting depth	quality of cut	for
2296000	4006885... ...229600	2 sabre saw blades	10 - 250 mm	quick, fine cuts	soft wood, plastic materials

6 POWER TOOL ACCESSORIES

6.1 Jigsaw blades



- material: HCS
- tooth form: straight-set and ground
- tooth distance: 2,4 - 4 mm
- toothed length: 180 mm
- total length: 200 mm
- packaging: plastic bag with inlay

article no.	EAN	description	cutting depth	quality of cut	for
2672000	4006885... ...267206	2 sabre saw blades	6 - 150 mm	fine, clean cuts	plywood, MDF, plastic material



- especially for curved cuts
- material: CV
- tooth form: straight-set and ground
- tooth distance: 4,2 mm
- toothed length: 130 mm
- total length: 150 mm
- used with a pendulum stroke
- packaging: plastic bag with inlay

article no.	EAN	description	cutting depth	quality of cut	for
3566000	4006885... ...356603	2 sabre saw blades	10 - 100 mm	quick, fine curved cuts	chipboards, plywood, plastic materials



- material: CV
- tooth form: straight-set and ground
- tooth distance: 5 mm
- tooth version: extra sharp toothing
- toothed length: 210 mm
- total length: 230 mm
- used without a pendulum stroke
- packaging: plastic bag with inlay

article no.	EAN	description	cutting depth	quality of cut	for
2295000	4006885... ...229501	2 sabre saw blades	10 - 180	fast, rough cuts	wooden beams, tree cutting

POWER TOOL ACCESSORIES 6

6.1 Jigsaw blades

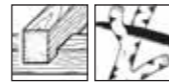

- material: CV
- tooth form: straight-set and milled
- tooth distance: 8,5 mm
- toothed length: 210 mm
- total length: 230 mm
- packaging: plastic bag with inlay



article no.	EAN	description	cutting depth	quality of cut	for
2291000	4006885... ...229105	2 sabre saw blades	20 - 180 mm	fast, very rough cuts	wooden beams, tree cutting

for metal working



- material: BiM
- tooth form: form-ground and milled
- tooth distance: 1,4 mm
- toothed length: 130 mm
- total length: 150 mm
- packaging: plastic bag with inlay



article no.	EAN	description	cutting depth	quality of cut	for
2298000	4006885... ...229808	2 sabre saw blades	1 - 3 mm	fine flush cuts	sheet steel, non-ferrous metals

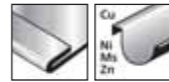

- material: BiM
- tooth form: form-ground and milled
- tooth distance: 2,5 mm
- toothed length: 130 mm
- total length: 150 mm
- used with a pendulum stroke
- packaging: plastic bag with inlay



article no.	EAN	description	cutting depth	quality of cut	for
2299000	4006885... ...229907	2 sabre saw blades	3 - 8 mm	rough cuts	sheet steel, non-ferrous metals

6 POWER TOOL ACCESSORIES

6.1 Jigsaw blades



- very flexible blade
- flush cuts
- material: BiM
- tooth form: straight-set and milled
- tooth distance: 1,4 mm
- toothed length: 210 mm
- total length: 230 mm
- used with a pendulum stroke
- packaging: plastic bag with inlay

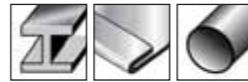

article no.	EAN	description	cutting depth	quality of cut	for
2696000	4006885... ...269606	2 sabre saw blades	1,5 - 4 mm	fine cuts	sheet steel, steel, tubes



- very flexible blade
- material: BiM
- tooth form: form-ground and milled
- tooth distance: 1,4 mm
- toothed length: 130 mm
- total length: 150 mm
- packaging: plastic bag with inlay

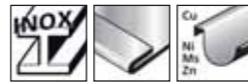

article no.	EAN	description	cutting depth	quality of cut	for
2297000	4006885... ...229709	2 sabre saw blades	1 - 3 mm	fine flush cuts	sheet steel, non-ferrous metals, Inox



- very flexible blade
- material: BiM
- tooth form: form-ground and milled
- tooth distance: 1,8 mm
- toothed length: 130 mm
- total length: 150 mm
- packaging: plastic bag with inlay



article no.	EAN	description	cutting depth	quality of cut	for
2293000	4006885... ...229303	2 sabre saw blades	2 - 8 mm	fine flush cuts	sheet steel, non-ferrous metals, aluminium

POWER TOOL ACCESSORIES 6

6.1 Jigsaw blades



- very flexible blade
- material: BiM
- tooth form: form-ground and milled
- tooth distance: 1,8 mm
- toothed length: 210 mm
- total length: 230 mm
- packaging: plastic bag with inlay



article no.	EAN	description	cutting depth	quality of cut	for
2292000	4006885... ...229204	2 sabre saw blades	2 - 8 mm	fine flush cuts	non-ferrous metals, aluminium, cast pipes



- low-vibration, high-precision angle cuts
- material: BiM
- tooth form: straight-set and milled
- tooth distance: 2,5 mm
- toothed length: 200 mm
- total length: 220 mm
- packaging: plastic bag with inlay



article no.	EAN	description	cutting depth	quality of cut	for
2679000	4006885... ...267909	2 sabre saw blades	3 - 190 mm	fine, precise cuts	metal profiles, tubes, sheet steel

Universal blades



- material: BiM
- used with a pendulum stroke
- tooth form: straight-set and milled
- tooth distance: 1,8 mm, 2,6 mm
- tooth version: vario-toothed
- toothed length: 210 mm
- total length: 230 mm
- packaging: plastic bag with inlay

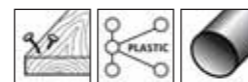

article no.	EAN	description	cutting depth	quality of cut	for
3568000	4006885... ...356801	2 sabre saw blades	5 - 180 mm 3 - 10 mm	rough cuts rough cuts	plastic material, wood with nails cast pipes

6 POWER TOOL ACCESSORIES

6.1 Jigsaw blades



- material: BiM
- used with a pendulum stroke
- tooth form: straight-set and milled
- tooth distance: 2,2 - 3,2 mm
- toothed length: 210 mm
- total length: 230 mm
- packaging: plastic bag with inlay

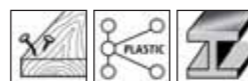

article no.	EAN	description	cutting depth	quality of cut	for
2673000	4006885... ...267305	2 sabre saw blades	< 175 mm 3,5 - 12 mm	rough cuts rough cuts	plastic material, wood with nails steel



- material: BiM
- used with a pendulum stroke
- tooth form: straight-set and milled
- tooth distance: 1,8 mm, 2,6 mm
- tooth version: vario-toothing
- toothed length: 130 mm
- total length: 150 mm
- packaging: plastic bag with inlay



article no.	EAN	description	cutting depth	quality of cut	for
3567000	4006885... ...356702	2 sabre saw blades	5 - 100 mm 3 - 10 mm	rough cuts rough cuts	wood with nails aluminium



- flexible and break-proof
- material: BiM
- used with a pendulum stroke
- tooth form: straight-set and milled
- tooth distance: 2,5 mm
- toothed length: 130 mm
- total length: 150 mm
- packaging: plastic bag with inlay



article no.	EAN	description	cutting depth	quality of cut	for
2695000	4006885... ...269507	2 sabre saw blades	< 100 mm 3 - 12 mm	rough cuts rough cuts	wood with nails steel, non-ferrous metals

POWER TOOL ACCESSORIES 6

6.1 Jigsaw blades



- disassembly blade for all types of demolition work
- heavy-duty saw blade
- material: BiM
- tooth form: straight-set and milled
- tooth distance: 4,2 mm
- toothed length: 210 mm
- total length: 230 mm
- packaging: plastic bag with inlay



article no.	EAN	description	cutting depth	quality of cut	for
2677000	4006885... ...267701	2 sabre saw blades	5 - 190 mm	fine cuts	hardwood, wood with nails, aluminium profiles, thin steel profiles, tubes



- flexible and break-proof
- material: BiM
- tooth form: straight-set and milled
- tooth distance: 4,2 mm
- toothed length: 280 mm
- total length: 300 mm
- used with a pendulum stroke
- packaging: plastic bag with inlay



article no.	EAN	description	cutting depth	quality of cut	for
2671000	4006885... ...267107	2 sabre saw blades	6 - 250 mm	fine cuts	wood with nails, MDF, plastic material



- Ideal for cutting out old windows
- material: BiM
- tooth form: straight-set and milled
- tooth distance: 4,2 mm
- toothed length: 130 mm
- total length: 150 mm
- used with a pendulum stroke
- packaging: plastic bag with inlay



article no.	EAN	description	cutting depth	quality of cut	for
2678000	4006885... ...267800	2 sabre saw blades	6 - 100 mm	rough curved cuts	hardwood, wood with nails, plastic materials

6 POWER TOOL ACCESSORIES

6.1 Jigsaw blades

Assortments



- packaging: plastic bag with inlay

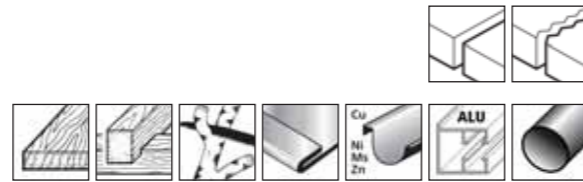

article no.	EAN	description	material	cutting depth	quality of cut	for
3599000	4006885... ...359901	5 sabre saw blades	CV	5 - 100 mm	fine cuts	wood, non-ferrous metals
			CV	10 - 180 mm	fast, rough cuts	wooden beams, tree cutting
			CV	20 - 190 mm	fast, very rough cuts	soft wood, tree cutting
			BiM	2 - 8 mm	fine flush cuts	non-ferrous metals, aluminium, cast pipes
			BiM	1 - 3 mm	straight, fine cuts	sheet steel, non-ferrous metals



- packaging: plastic bag on card



article no.	EAN	description	material	cutting depth	quality of cut	for
8437000	4006885... ...843707	3 sabre saw blades	CV	3 - 100 mm	fine cuts	wood, plastic materials
			CV	20 - 180 mm	fast, very rough cuts	wooden beams, tree cutting
			HSS	1 - 3 mm	straight, fine cuts	sheet steel, non-ferrous metals

POWER TOOL ACCESSORIES 6

6.1 Jigsaw blades

Sable saw blades for Tandem sabre saw

suitable for Bosch PFZ 1200 A, Bosch PFZ 1300 AE



- material: HCS
- tooth distance: 10 mm
- toothed length: 275 mm
- total length: 359 mm
- version: precision ground
- packaging: plastic bag with inlay



article no.	EAN	description	quality of cut	for
2396000	...239609	1 set of sabre saw blades	rough cuts	soft wood, chipboards, wooden beams, plastic materials

Accessories for multi saw Bosch, KRAFTRONIC, Kress

suitable for Bosch, KRAFTRONIC, Kress



- material: HCS
- tooth form: straight-set and ground
- tooth distance: 4 mm
- toothed length: 125 mm
- total length: 150 mm
- version: conical back
- packaging: plastic bag with inlay



article no.	EAN	description	shank	cutting depth	quality of cut	for
2669000	...266902	2 saw blades	T-shank	100 mm	rough cuts	hardwood, chipboards, plywood

6 POWER TOOL ACCESSORIES

6.1 Jigsaw blades

Helical planer blades



- machine: electric hand planes
- can be used from both sides
- material: TCT
- for all types of wood, chipboards, wood core chipboards
- packaging: plastic bag with inlay

article no.	EAN	description	suitable for	product dimensions
4110000	...411005 4006885...	2 helical planer blades	AEG, Black & Decker, Bosch, Festo, Haffner, Holz-Her, Kress, MAFELL, Metabo, Scheer, Skil	1.1 x 75.5 x 5.5 mm
4111000	...411104	2 helical planer blades	Black & Decker	1.1 x 82.7 x 5.5 mm
4113000	...411302	2 helical planer blades	AEG, Black & Decker, Bosch, Fein, Festo, Haffner, Hitachi, Holz-Her, MAFELL, Makita, Metabo, Skil	1.1 x 82 x 5.5 mm



6 POWER TOOL ACCESSORIES

6.2 Hole saws / Annular bits



Secondary placement product for electric department. Packaging with user-oriented communication.



- for pipe installations and flush sockets
- for concrete, breeze blocks, bricks, natural stones, artificial stones
- specially hardened, precise, wear-resistant drill shank
- specially soldered heat-resistant carbide plates
- version: mandrel SDS-plus, impact and shock resistant, 2 discharge holes
- including: 1 drill, \varnothing 8 mm, TCT
- packaging: double blister

article no.	EAN	description	\varnothing	cutting depth	thread
8914000	4006885... ...891401	1 hollow drill bit with mandrel SDS-plus	\varnothing 68 mm	46 mm	M 16



- for pipe installations and flush sockets
- for concrete, breeze blocks, bricks, natural stones, artificial stones
- specially hardened, precise, wear-resistant drill shank
- specially soldered heat-resistant carbide plates
- version: mandrel SDS-plus, impact and shock resistant, 2 discharge holes
- including: 1 drill, \varnothing 8 mm, TCT
- packaging: storage box on card
- separate accessories: 5425000, 5428000, 5482000

article no.	EAN	description	\varnothing	cutting depth	thread
5480000	4006885... ...548008	1 hollow drill bit with mandrel SDS-plus	\varnothing 40 mm	46 mm	M 16
5483000	...548305	1 hollow drill bit with mandrel SDS-plus	\varnothing 68 mm	46 mm	M 16
5460000	...546004	1 hollow drill bit with mandrel SDS-plus	\varnothing 76 mm	46 mm	M 16
5481000	...548107	1 hollow drill bit with mandrel SDS-plus	\varnothing 83 mm	46 mm	M 16
5490000	...549005	1 hollow drill bit with mandrel SDS-plus	\varnothing 105 mm	46 mm	M 16

POWER TOOL ACCESSORIES

6.2 Hole saws / Annular bits

6



- version: impact and shock resistant
- packaging: paperboard card
- separate accessories: 5482000
- suitable for 5460000, 5480000, 5481000, 5483000, 5490000

article no.	EAN 4006885...	description	shank length	shank	thread	drill	drill length
5428000	...542808	1 mandrel with centring drill	110 mm	SDS-plus	M 16	ø 8 mm	70 mm
5425000	...542501	1 mandrel with centring drill	220 mm	SDS-plus	M 16	ø 8 mm	70 mm

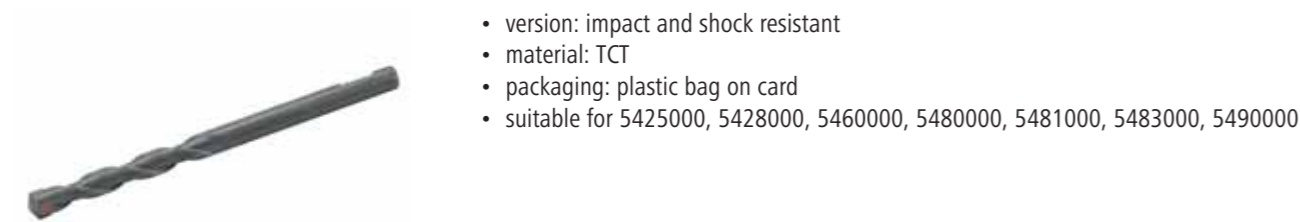

- version: impact and shock resistant
- material: TCT
- packaging: plastic bag on card
- suitable for 5425000, 5428000, 5460000, 5480000, 5481000, 5483000, 5490000

article no.	EAN 4006885...	description	Ø
5482000	...548206	1 centring drill	ø 8 mm

Assortments



- for drilling holes for sockets
- suitable for all common socket combinations
- for brick walls, concrete, natural stone, wood, metal, plastic material
- content:
 - 1 hollow drill bit with mandrel SDS-plus, TCT, ø 68 mm
 - 1 hole saw, BiM, ø 68 mm, with hexagon shank, centring drill
 - 1 template
- in plastic case

article no.	EAN 4006885...	description
5982000	...598201	1 hole saw set "Universal"

6 POWER TOOL ACCESSORIES

6.2 Hole saws / Annular bits

Diamond hollow drill bits



- for mounting power sockets, distribution sockets and cavity sockets
- for brick walls
- quick, fine cuts
- work is vibration-free
- extremely long durability
- with brazed diamond segments
- version: 2 discharge holes, exterior conveyor screw
- packaging: storage box on card
- separate accessories: 5955000, 5956000

article no.	EAN	description	Ø	cutting depth	thread
7957000	...795709	1 diamond hollow drill bit	ø 68 mm	65 mm	M 16
7958000	...795808	1 diamond hollow drill bit	ø 82 mm	65 mm	M 16



- packaging: paperboard card
- suitable for 7957000, 7958000

article no.	EAN	description	shank	thread	drill	drill length
5955000	...595507	1 mandrel with centring drill	SDS-plus	M 16	ø 8 mm	80 mm
5956000	...595606	1 mandrel with centring drill	hexagon shank	M 16	ø 8 mm	80 mm

POWER TOOL ACCESSORIES

6.2 Hole saws / Annular bits

6

Conduit hole saws



- for all installation work (sockets, distribution boxes, tubes)
- for brick walls, bricks, breeze blocks, plasterboards, Earthenware wall tiles
- material: tungsten carbide coated
- packaging: storage box on card



article no.	EAN 4006885...	description	Ø	cutting depth	separate accessories	suitable for
3473000	...347304	1 conduit hole saw	ø 33 mm	55 mm	3466000, 3472000	3464000, 3478000, 5424000
3468000	...346802	1 conduit hole saw	ø 43 mm	55 mm	3466000, 3472000	5424000
3474000	...347403	1 conduit hole saw	ø 53 mm	55 mm	3466000, 3472000	3464000, 3478000, 5424000
3477000	...347700	1 conduit hole saw	ø 68 mm	55 mm	3466000, 3472000	3464000, 5424000
3475000	...347502	1 conduit hole saw	ø 73 mm	55 mm	3466000, 3472000	3464000, 3470000, 3478000
3476000	...347601	1 conduit hole saw	ø 83 mm	55 mm	3466000, 3472000	3464000, 3478000
3467000	...346703	1 conduit hole saw	ø 103 mm	55 mm	3466000	5424000



- for article no. 3472000: hole saws ø 33 - 83 mm
- for article no. 3466000: hole saws ø 33 - 103 mm
- packaging: paperboard card
- separate accessories: 3471000

3472000

3466000

article no.	EAN 4006885...	description	Ø	suitable for
3472000	...347205	1 receptacle plate	ø 90 mm	3464000, 3465000, 3468000, 3470000, 3473000, 3474000, 3475000, 3476000, 3477000, 3478000, 5424000
3466000	...346604	1 receptacle plate	ø 110 mm	3467000, 3468000, 3473000, 3474000, 3475000, 3476000, 3477000, 5424000

6 POWER TOOL ACCESSORIES

6.2 Hole saws / Annular bits

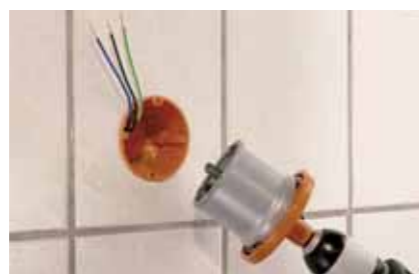

- for receptacle plate
- material: TCT
- packaging: paperboard card
- suitable for 1003000, 3464000, 3465000, 3466000, 3470000, 3472000, 3478000, 3893000, 3894000, 3895000, 3896000, 3897000, 3898000, 3899000, 5424000, 8913000

article no.	EAN	description	∅	length
3471000	4006885... ...347106	1 centring drill	∅ 8 mm	140 mm

Conduit hole saws

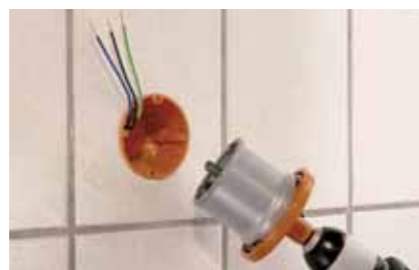

- for all installation work (sockets, distribution boxes, tubes)
- for brick walls, bricks, breeze blocks, gypsum plaster boards, Earthenware wall tiles
- complete with receptacle plate and centering drill
- material: tungsten carbide coated
- packaging: storage box on card



article no.	EAN	description	∅	cutting depth	separate accessories
3478000	4006885... ...347809	1 conduit hole saw set	∅ 33, 53, 73, 83 mm	55 mm	3471000, 3472000, 3473000, 3474000, 3475000, 3476000
3465000	...346505	1 conduit hole saw with receptacle plate and centring drill	∅ 67 mm	55 mm	3471000, 3472000
3470000	...347007	1 conduit hole saw with receptacle plate and centring drill	∅ 73 mm	55 mm	3471000, 3472000, 3475000

POWER TOOL ACCESSORIES

6

6.2 Hole saws / Annular bits



5424000



3464000

- for all installation work (sockets, distribution boxes, tubes)
- for brick walls, bricks, breeze blocks, plasterboards, Earthenware wall tiles
- material: tungsten carbide coated
- in plastic case
- packaging: sticker

article no.	EAN 4006885...	description	cutting depth	content	separate accessories
3464000	...346406	1 conduit hole saw set "brick walls"	55 mm	5 hole saw blades ø 33, 53, 68, 73, 83 mm 1 receptacle plate 1 centring drill	3471000, 3472000, 3473000, 3474000, 3475000, 3476000, 3477000
5424000	...542402	1 conduit hole saw set "brick walls"	55 mm	5 hole saw blades ø 33, 43, 53, 68, 103 mm 1 receptacle plate 1 centring drill	3466000, 3467000, 3468000, 3471000, 3472000, 3473000, 3474000, 3477000

Hole saws tungsten carbide coated



Secondary placement product for electric department. Packaging with user-oriented communication.

- to install flush sockets
- for brick walls, bricks, breeze blocks, gypsum plaster boards, tiles
- directly useable - no separate mandrel required
- also suitable for deep boreholes
- material: tungsten carbide coated
- including: 1 centring drill TCT, ø 8 mm, with hexagon shank
- packaging: storage box on card
- separate accessories: 3471000, 3862000



article no.	EAN 4006885...	description	Ø	cutting depth
8913000	...891302	1 hole saw tungsten carbide coated with shank and drill	ø 68 mm	55 mm

6 POWER TOOL ACCESSORIES

6.2 Hole saws / Annular bits



- for all installation work (sockets, distribution boxes, tubes)
- for brick walls, bricks, breeze blocks, gypsum plaster boards, tiles
- directly useable - no separate mandrel required
- also suitable for deep boreholes
- material: tungsten carbide coated
- including: 1 centring drill TCT, \varnothing 8 mm, with hexagon shank
- packaging: storage box on card
- separate accessories: 3471000, 3862000

article no.	EAN 4006885...	description	\varnothing	cutting depth
3893000	...389304	1 hole saw tungsten carbide coated with shank and drill	\varnothing 33 mm	55 mm
3894000	...389403	1 hole saw tungsten carbide coated with shank and drill	\varnothing 43 mm	55 mm
3895000	...389502	1 hole saw tungsten carbide coated with shank and drill	\varnothing 53 mm	55 mm
3896000	...389601	1 hole saw tungsten carbide coated with shank and drill	\varnothing 68 mm	55 mm
3897000	...389700	1 hole saw tungsten carbide coated with shank and drill	\varnothing 73 mm	55 mm
3898000	...389809	1 hole saw tungsten carbide coated with shank and drill	\varnothing 83 mm	55 mm
3899000	...389908	1 hole saw tungsten carbide coated with shank and drill	\varnothing 103 mm	55 mm



- for hole saws tungsten carbide coated with shank and drill
- for drilling deep holes
- material: TCT
- suitable for 1003000, 3893000, 3894000, 3895000, 3896000, 3897000, 3898000, 3899000, 8913000

article no.	EAN 4006885...	description	\varnothing	shank	length
3862000	...386204	1 centring drill	\varnothing 8 mm	hexagon shank	220 mm

POWER TOOL ACCESSORIES

6.2 Hole saws / Annular bits

6



- for all installation work (sockets, distribution boxes, tubes)
- for brick walls, bricks, breeze blocks, gypsum plaster boards, tiles
- also suitable for deep boreholes
- material: tungsten carbide coated
- content:
 - 2 TCT-centring drill, 140, 220 mm
 - 3 hole saws, ø 33, 53, 68 mm
- in 2-component plastic case, maxi
- separate accessories: 3471000, 3862000



article no.	EAN	description	cutting depth
1003000	4006885... ...100305	1 hole saw set 5 pcs., tungsten carbide coated	55 mm

Bi-metal hole saw blades



- for cast steel, grey cast iron, stainless HCS steel, construction steel, aluminium, bronze, copper, PVC, acrylic glass, wood, gypsum plaster boards
- high durability
- smooth running
- material: BiM, specially alloyed tool body with HSS teeth
- packaging: storage box on card



article no.	EAN	description	Ø	cutting depth	thread	separate accessories
3490000	4006885... ...349001	1 hole saw blade	ø 20 mm	40 mm	1/2" (12,7 mm)	5957000
3767000	...376700	1 hole saw blade	ø 25 mm	40 mm	1/2" (12,7 mm)	5957000
3491000	...349100	1 hole saw blade	ø 29 mm	40 mm	1/2" (12,7 mm)	5957000
3768000	...376809	1 hole saw blade	ø 32 mm	40 mm	5/8" (15,88 mm)	5958000
3492000	...349209	1 hole saw blade	ø 35 mm	40 mm	5/8" (15,88 mm)	5958000
3770000	...377004	1 hole saw blade	ø 40 mm	40 mm	5/8" (15,88 mm)	5958000
3493000	...349308	1 hole saw blade	ø 51 mm	40 mm	5/8" (15,88 mm)	5958000
3772000	...377202	1 hole saw blade	ø 60 mm	40 mm	5/8" (15,88 mm)	5958000
3494000	...349407	1 hole saw blade	ø 68 mm	40 mm	5/8" (15,88 mm)	5958000

6 POWER TOOL ACCESSORIES

6.2 Hole saws / Annular bits



- shank: hexagon shank
- including: HSS centring drill Ø 6 mm
- packaging: paperboard card
- separate accessories: 5479000

article no.	EAN	description	for	thread	length	suitable for
5957000	4006885... ...595705	1 mandrel with centring drill	for hole saw blades ø 19 - 29 mm	1/2" (12,7 mm)	68 mm	3490000, 3491000, 3767000
5958000	4006885... ...595804	1 mandrel with centring drill	for hole saw blades from ø 32 mm	5/8" (15,88 mm)	68 mm	3492000, 3493000, 3494000, 3768000, 3770000, 3772000

Assortments for stainless steel, metals



- for cast steel, grey cast iron, stainless HCS steel, construction steel, aluminium, bronze, copper, PVC, acrylic glass
- material: BiM
- in plastic case
- packaging: sticker
- separate accessories: 5479000

article no.	EAN	description	content
3498000	4006885... ...349803	1 hole saw set "electricity and sanitary"	5 hole saw blades ø 25, 29, 35, 51, 68 mm 1 mandrel with centring drill, HSS

Assortments for wood, metals



5422000

5423000

3764000

- for wood, plywood, steel, non-ferrous heavy metals, plastic materials, gypsum plaster boards
- material: BiM
- in plastic case
- packaging: sticker
- separate accessories: 5479000



article no.	EAN	description	content
5422000	4006885... ...542204	1 hole saw set "sanitary"	5 hole saw blades ø 25, 35, 43, 54, 83 mm 1 mandrel with centring drill



POWER TOOL ACCESSORIES

6.2 Hole saws / Annular bits

6



article no.	EAN 4006885...	description	content
3764000	...376403	1 hole saw set "electricity and sanitary"	5 hole saw blades ø 35, 40, 51, 65, 68 mm 1 mandrel with centring drill
5423000	...542303	1 hole saw set "electricity"	6 hole saw blades ø 40, 54, 65, 68, 74, 86 mm 1 mandrel with centring drill



- for wood, plywood, steel, non-ferrous heavy metals, plastic materials, gypsum plaster boards
- material: BiM
- in plastic case



article no.	EAN 4006885...	description	content
5980000	...598003	1 hole saw set "renovate"	3 hole saw blades ø 35, 43, 68 mm 1 mandrel with centring drill

Bi-metal hole saws



- for wood, plywood, steel, non-ferrous heavy metals, plastic materials, gypsum plaster boards
- BiM, specially alloyed tool body with HSS teeth
- directly useable - no separate mandrel required
- material: BiM, specially alloyed tool body with HSS teeth
- including: 1 centring drill HSS, ø 6 mm
- separate accessories: 5479000



article no.	EAN 4006885...	description	Ø	cutting depth	shank	packaging
5462000	...546202	1 hole saw	ø 20 mm	40 mm	hexagon shank	storage box on card
5463000	...546301	1 hole saw	ø 22 mm	40 mm	hexagon shank	storage box on card
5464000	...546400	1 hole saw	ø 25 mm	40 mm	hexagon shank	storage box on card
5465000	...546509	1 hole saw	ø 29 mm	40 mm	hexagon shank	storage box on card
5466000	...546608	1 hole saw	ø 32 mm	40 mm	hexagon shank	storage box on card
5467000	...546707	1 hole saw	ø 35 mm	40 mm	hexagon shank	storage box on card
5469000	...546905	1 hole saw	ø 40 mm	40 mm	hexagon shank	storage box on card
5470000	...547001	1 hole saw	ø 45 mm	40 mm	hexagon shank	storage box on card
5471000	...547100	1 hole saw	ø 51 mm	40 mm	hexagon shank	storage box on card
5472000	...547209	1 hole saw	ø 54 mm	40 mm	hexagon shank	storage box on card
5484000	...548404	1 hole saw	ø 60 mm	40 mm	hexagon shank	storage box on card



6 POWER TOOL ACCESSORIES

6.2 Hole saws / Annular bits



article no.	EAN 4006885...	description	Ø	cutting depth	shank	packaging
5473000	...547308	1 hole saw	Ø 65 mm	40 mm	hexagon shank	storage box on card
5474000	...547407	1 hole saw	Ø 68 mm	40 mm	hexagon shank	storage box on card
5475000	...547506	1 hole saw	Ø 74 mm	40 mm	hexagon shank	storage box on card
5455000	...545502	1 hole saw	Ø 75 mm	40 mm	hexagon shank	storage box on card
5494000	...549401	1 hole saw	Ø 76 mm	40 mm	hexagon shank	storage box on card
5485000	...548503	1 hole saw	Ø 80 mm	40 mm	hexagon shank	storage box on card
5476000	...547605	1 hole saw	Ø 83 mm	40 mm	hexagon shank	storage box on card
5456000	...545601	1 hole saw	Ø 85 mm	40 mm	hexagon shank	storage box on card
5486000	...548602	1 hole saw	Ø 86 mm	40 mm	hexagon shank	storage box on card
5492000	...549203	1 hole saw	Ø 92 mm	40 mm	hexagon shank	storage box on card
5493000	...549302	1 hole saw	Ø 100 mm	40 mm	hexagon shank	storage box on card
5496000	...549609	1 hole saw	Ø 112 mm	40 mm	hexagon shank	fixed on card
5497000	...549708	1 hole saw	Ø 121 mm	40 mm	hexagon shank	fixed on card
5495000	...549500	1 hole saw	Ø 127 mm	40 mm	hexagon shank	fixed on card
5498000	...549807	1 hole saw	Ø 152 mm	40 mm	hexagon shank	fixed on card



- material: HSS
- packaging: blister on card
- suitable for 3498000, 3764000, 5422000, 5423000, 5455000, 5456000, 5462000, 5463000, 5464000, 5465000, 5466000, 5467000, 5469000, 5470000, 5471000, 5472000, 5473000, 5474000, 5475000, 5476000, 5484000, 5485000, 5486000, 5492000, 5493000, 5494000, 5495000, 5496000, 5497000, 5498000, 5957000, 5958000

article no.	EAN 4006885...	description	Ø	length
5479000	...547902	1 centring drill	Ø 6 mm	68 mm

Carbon steel hole saws



- ideal for drywall installation
- for plasterboards, soft wood, OSB panels, plywood, chipboards
- with hexagonal shank suitable for all power drills and cordless screwdrivers, up to 68 mm Ø additionally in drills with 1/4" receptacle or in bit holders
- special tooth geometry for fine and clean cuts
- drill core can be easily removed from the drill bit
- also suitable for cordless power tools with low driving force thanks to triple tooth groups
- straight-set groups of teeth
- packaging: storage box on card



article no.	EAN 4006885...	description	Ø	cutting depth	shank
5963000	...596306	1 carbon steel hole saw	Ø 25 mm	30 mm	hexagon shank 1/4" (6,35 mm)



POWER TOOL ACCESSORIES

6.2 Hole saws / Annular bits

6



article no.	EAN 4006885...	description	Ø	cutting depth	shank
5964000	...596405	1 carbon steel hole saw	Ø 35 mm	30 mm	hexagon shank 1/4" (6,35 mm)
5965000	...596504	1 carbon steel hole saw	Ø 40 mm	30 mm	hexagon shank 1/4" (6,35 mm)
5966000	...596603	1 carbon steel hole saw	Ø 60 mm	30 mm	hexagon shank 1/4" (6,35 mm)
5967000	...596702	1 carbon steel hole saw	Ø 65 mm	30 mm	hexagon shank 1/4" (6,35 mm)
5968000	...596801	1 carbon steel hole saw	Ø 68 mm	30 mm	hexagon shank 1/4" (6,35 mm)
5969000	...596900	1 carbon steel hole saw	Ø 74 mm	30 mm	hexagon shank
5970000	...597006	1 carbon steel hole saw	Ø 76 mm	30 mm	hexagon shank
5971000	...597105	1 carbon steel hole saw	Ø 86 mm	30 mm	hexagon shank
5972000	...597204	1 carbon steel hole saw	Ø 105 mm	30 mm	hexagon shank
5973000	...597303	1 carbon steel hole saw	Ø 127 mm	30 mm	hexagon shank



article no.	EAN 4006885...	description	Ø	cutting depth	shank
5974000	...597402	1 carbon steel hole saw set	Ø 86, 127 mm	30 mm	hexagon shank

Adjustable hole saws

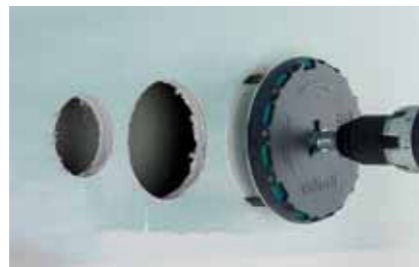

- for plasterboards, OSB panels, soft wood, plywood
- just one product for all standard radii in drywall installation
- convenient infinite adjustment in three steps: loosen – adjust synchronously – fasten
- special tooth geometry for fine and clean cuts
- three integrated scales for all standard dimensions
- protected work area thanks to large drill disc
- reliable dust extraction for permanently functional positioning mechanism
- with three straight-set, toothed blades
- including:
 - 1 hexagonal key, SW 2,5
 - 1 hexagonal key, SW 4
- packaging: double card with inlaid blister
- separate accessories: 5979000

article no.	EAN 4006885...	description	Ø	cutting depth	shank
5977000	...597709	1 AH 45-90 - adjustable hole saw	Ø 45 - 90 mm	30 mm	triangular shank



6 POWER TOOL ACCESSORIES

6.2 Hole saws / Annular bits



article no.	EAN	description	∅	cutting depth	shank
5978000	4006885... ...597808	1 AH 45-130 - adjustable hole saw	∅ 45 - 130 mm	30 mm	triangular shank



For the preparation of electrical installations in drywall structures

- for plasterboards, OSB panels, soft wood
- integrated scale for all standard dimensions: ∅ 35, 65, 68, 74, 76, 83 mm
- size adjustable
- special tooth geometry for fine and clean cuts
- with three straight-set, toothed blades
- including:
 - 1 hexagonal key, SW 2,5
 - 1 hexagonal key, SW 4
- packaging: blister on card
- separate accessories: 5979000

article no.	EAN	description	∅	cutting depth	shank	shank
5983000	4006885... ...598300	1 adjustable hole saw for electrical installations	∅ 35, 65, 68, 74, 76, 83 mm	30 mm	triangular shank	∅ 8.5 mm



for the preparation of plumbing installations in drywall structures

- for plasterboards, OSB panels, soft wood
- integrated scale for all standard dimensions: ∅ 35, 50, 54, 63, 67, 83 mm
- size adjustable
- special tooth geometry for fine and clean cuts
- with three straight-set, toothed blades
- including:
 - 1 hexagonal key, SW 2,5
 - 1 hexagonal key, SW 4
- packaging: blister on card
- separate accessories: 5979000

article no.	EAN	description	∅	cutting depth	shank	shank
5984000	4006885... ...598409	1 adjustable hole saw for plumbing installations	∅ 35, 50, 54, 63, 67, 83 mm	30 mm	triangular shank	∅ 8.5 mm

POWER TOOL ACCESSORIES 6

6.2 Hole saws / Annular bits



for all standard diameters for interior works

- for plasterboards, OSB panels, soft wood
- integrated scale for all commonly used dimensions: Ø 35, 50, 65, 68, 74, 80 mm
- size adjustable
- special tooth geometry for fine and clean cuts
- with three straight-set, toothed blades
- including:
 - 1 hexagonal key, SW 2,5
 - 1 hexagonal key, SW 4
- packaging: blister on card
- separate accessories: 5979000

article no.	EAN	description	Ø	cutting depth	shank	shank
5985000	4006885... ...598508	1 adjustable universal hole saw	Ø 35, 50, 65, 68, 74, 80 mm	30 mm	triangular shank	Ø 8.5 mm



for the preparation of spotlight installations

- for plasterboards, OSB panels, soft wood
- integrated scale for spotlights from the best-known manufacturers: Ø 35, 55, 60, 68, 70, 75, 80, 85 mm
- size adjustable
- special tooth geometry for fine and clean cuts
- with three straight-set, toothed blades
- including:
 - 1 hexagonal key, SW 2,5
 - 1 hexagonal key, SW 4
- packaging: blister on card
- separate accessories: 5979000

article no.	EAN	description	Ø	cutting depth	shank	shank
5986000	4006885... ...598607	1 adjustable hole saw for installation of recessed lighting	Ø 35, 55, 60, 68, 70, 75, 80, 85 mm	30 mm	triangular shank	Ø 8.5 mm

6 POWER TOOL ACCESSORIES

6.2 Hole saws / Annular bits



- for plasterboards, OSB panels, soft wood
- packaging: plastic bag on card
- suitable for 5977000, 5978000, 5983000, 5984000, 5985000, 5986000

article no.	EAN	description
5979000	4006885... ...597907	3 replacement blades

Professional hole saws



the recess cutter facilitates the flush installation of wall sockets in one work step

The precision hole saw for perfect and quick working

- for wood, plastic materials, gypsum plaster boards, construction panels
- the ejector ejects the drill core automatically
- hardened cutting teeth and a recess cutter for clean cuts and a long service life
- version: with ejector and deburrer
- including: 1 centring drill HCS, \varnothing 6 mm
- packaging: storage box on card
- complementary products: 4050000

article no.	EAN	description	\varnothing	shank
2158000	4006885... ...215801	1 hole saw	\varnothing 68 mm	triangular shank

POWER TOOL ACCESSORIES

6.2 Hole saws / Annular bits

6



The professional hole saw in industrial quality

- for wood, plastic materials, gypsum plaster boards, construction panels, non-ferrous metals
- version: tungsten steel saw blades
- metal body
- including:
 - 1 centring drill HSS, \varnothing 6 mm
 - 5 quick-change saw blades
- packaging: storage box on card



article no.	EAN	description	quick change saw blades	cutting depth	shank
2220000	4006885... ...222007	1 professional hole saw	\varnothing 28, 35, 50, 68, 75 mm	40 mm	hexagon shank



- for wood, gypsum plaster boards, construction panels, non-ferrous metals
- high cutting performance
- version: tungsten steel saw blades
- metal body
- including:
 - 1 centring drill, \varnothing 8 mm
 - 3 quick-change saw blades
- packaging: storage box on card



article no.	EAN	description	quick change saw blades	cutting depth	shank
2154000	4006885... ...215405	1 super hole saw	\varnothing 60, 68, 74 mm	33 mm	triangular shank



- for wood, gypsum plaster boards, construction panels, non-ferrous metals
- high cutting performance
- version: tungsten steel saw blades
- metal body
- including:
 - 1 centring drill, \varnothing 10 mm
 - 5 quick-change saw blades
- packaging: storage box on card



article no.	EAN	description	quick change saw blades	cutting depth	shank
2155000	4006885... ...215504	1 super hole saw	\varnothing 60, 68, 74, 80, 95 mm	40 mm	hexagon shank

6 POWER TOOL ACCESSORIES

6.2 Hole saws / Annular bits

Standard hole saws



- for mounting power sockets, distribution sockets and cavity sockets
- for wood, gypsum plaster boards, construction panels
- metal body
- including: 1 centring drill, \varnothing 6 mm
- packaging: fixed on card
- complementary products: 4050000



article no.	EAN	description	\varnothing	cutting depth	shank	shank
2157000	4006885... ...215702	1 standard hole saw	\varnothing 68 mm	23 mm	round shank	\varnothing 6 mm



- for wood, gypsum plaster boards, construction panels
- metal body
- including:
 - 1 centring drill, \varnothing 8 mm
 - 7 quick-change saw blades
- packaging: fixed on card



article no.	EAN	description	quick change saw blades	cutting depth	shank
2164000	4006885... ...216402	1 standard hole saw	\varnothing 25, 32, 38, 45, 50, 56, 62 mm	23 mm	triangular shank



- for wood, gypsum plaster boards, construction panels
- metal body
- including:
 - 1 centring drill, \varnothing 8 mm
 - 6 quick-change saw blades
- packaging: fixed on card



article no.	EAN	description	quick change saw blades	cutting depth	shank
2165000	4006885... ...216501	1 standard hole saw	\varnothing 25, 32, 40, 45, 54, 65 mm	23 mm	hexagon shank



- for wood, gypsum plaster boards, construction panels
- version: tungsten steel saw blades
- metal body
- including:
 - 1 centring drill, \varnothing 8 mm
 - 7 quick-change saw blades
- packaging: storage box on card



article no.	EAN	description	quick change saw blades	cutting depth	shank
2160000	4006885... ...216006	1 standard hole saw	\varnothing 25, 32, 38, 45, 50, 56, 62 mm	33 mm	triangular shank

POWER TOOL ACCESSORIES

6.2 Hole saws / Annular bits

6



- for wood, gypsum plaster boards, construction panels
- metal body
- including:
 - 1 centring drill, \varnothing 10 mm
 - 5 quick-change saw blades
- packaging: fixed on card



article no.	EAN	description	quick change saw blades	cutting depth	shank
2162000	4006885... ...216204	1 standard hole saw	\varnothing 60, 68, 74, 80, 95 mm	33 mm	hexagon shank



- Secondary placement product for electric department. Packaging with user-oriented communication.
- for mounting power sockets, distribution sockets and cavity sockets
 - for wood, gypsum plaster boards, construction panels
 - metal body
 - including: 1 centring drill, \varnothing 6 mm
 - packaging: double blister



article no.	EAN	description	\varnothing	cutting depth	shank	shank
8912000	4006885... ...891203	1 standard hole saw	\varnothing 68 mm	33 mm	round shank	\varnothing 6 mm



- Secondary placement product for sanitaryware department. Packaging with user-oriented communication.
- for wood, gypsum plaster boards, construction panels
 - metal body
 - including:
 - 1 centring drill, \varnothing 8 mm
 - 4 quick-change saw blades
 - packaging: double blister



article no.	EAN	description	quick change saw blades	cutting depth	shank
8917000	4006885... ...891708	1 standard hole saw	\varnothing 25, 35, 43, 53 mm	33 mm	hexagon shank



- Secondary placement product for electric department. Packaging with user-oriented communication.
- for wood, gypsum plaster boards, construction panels
 - metal body
 - including:
 - 1 centring drill, \varnothing 10 mm
 - 5 quick-change saw blades
 - packaging: double blister



article no.	EAN	description	quick change saw blades	cutting depth	shank
8918000	4006885... ...891807	1 standard hole saw	\varnothing 68, 74, 80, 90, 100 mm	38 mm	hexagon shank

6 POWER TOOL ACCESSORIES

6.2 Hole saws / Annular bits



Secondary placement product for electric department. Packaging with user-oriented communication.



- for mounting power sockets, distribution sockets and cavity sockets
- for wood, gypsum plaster boards, construction panels
- metal body
- including:
 - 1 centring drill, \varnothing 8 mm
 - 3 quick-change saw blades
- packaging: double blister

article no.	EAN	description	quick change saw blades	cutting depth	shank
8916000	4006885... ...891609	1 standard hole saw	\varnothing 40, 54, 65 mm	40 mm	triangular shank



- for wood, gypsum plaster boards, construction panels
- plastic body
- including:
 - 1 centring drill, \varnothing 6 mm
 - 7 quick-change saw blades
- packaging: fixed on card

article no.	EAN	description	quick change saw blades	cutting depth	shank	shank
2161000	4006885... ...216105	1 standard hole saw	\varnothing 25, 32, 38, 45, 50, 56, 62 mm	18 mm	round shank	\varnothing 6 mm



- for wood, gypsum plaster boards, construction panels
- plastic body
- including:
 - 1 centring drill, \varnothing 6 mm
 - 3 quick-change saw blades
- packaging: fixed on card

article no.	EAN	description	quick change saw blades	cutting depth	shank	shank
2169000	4006885... ...216907	1 standard hole saw	\varnothing 40, 54, 65 mm	18 mm	round shank	\varnothing 6 mm

6.2 Hole saws / Annular bits



- for wood, gypsum plaster boards, construction panels
- plastic body
- including: 1 centring drill, \varnothing 6 mm
- packaging: fixed on card
- complementary products: 4050000

article no.	EAN	description	\varnothing	cutting depth	shank	shank
3777000	4006885... ...377707	1 standard hole saw	\varnothing 65 mm	32 mm	round shank	\varnothing 6 mm

Universal hole saws



- for wood, plastic materials, brick walls, gypsum blocks, porous concrete, eternit, heraklith plates, bricks, gypsum plaster boards
- with special TCT cutting edges for precise cuts
- excellent discharge of chips due to the large chip spaces
- directly useable - no separate mandrel required
- material: TCT
- including: 1 centring drill TCT, \varnothing 8 mm
- packaging: storage box on card



article no.	EAN	description	\varnothing	cutting depth	shank	separate accessories
3874000	4006885... ...387409	1 universal hole saw	\varnothing 25 mm	60 mm	hexagon shank	
3876000	...387607	1 universal hole saw	\varnothing 35 mm	60 mm	hexagon shank	
3879000	...387904	1 universal hole saw	\varnothing 50 mm	60 mm	hexagon shank	
3882000	...388208	1 universal hole saw	\varnothing 68 mm	60 mm	hexagon shank	
3885000	...388505	1 universal hole saw	\varnothing 85 mm	60 mm	hexagon shank	
3887000	...388703	1 universal hole saw	\varnothing 105 mm	60 mm	hexagon shank	
5960000	...596009	1 universal hole saw	\varnothing 112 mm	60 mm	hexagon shank	5959000
5961000	...596108	1 universal hole saw	\varnothing 127 mm	60 mm	hexagon shank	5959000
5962000	...596207	1 universal hole saw	\varnothing 152 mm	60 mm	hexagon shank	5959000



- packaging: paperboard card
- suitable for 5960000, 5961000, 5962000

article no.	EAN	description	shank	thread	length
5959000	4006885... ...595903	1 mandrel	hexagon shank	5/8" (15,88 mm)	372 mm

6 POWER TOOL ACCESSORIES

6.2 Hole saws / Annular bits

Diamond drills »Ceramic«



Simple handling: Just put the diamond drill in the chuck of the cordless drill, drill and that's it!

- machine: cordless screwdrivers
- applicable for attachments for sanitarian equipment and cable bushings
- for tiles, fine stoneware, granite plates, glazed tiles
- sawing edge coated with quality industrial diamonds which even drill through the hardest materials
- main body turned out of solid material - for permanent precision work
- packaging: blister on card
- separate accessories: 5911000



article no.	EAN 4006885...	description	Ø	cutting depth	shank
5915000	...591509	1 diamond drill "Ceramic"	Ø 5 mm	30 mm	Ø 10 mm
5916000	...591608	1 diamond drill "Ceramic"	Ø 6 mm	30 mm	Ø 10 mm
5917000	...591707	1 diamond drill "Ceramic"	Ø 8 mm	30 mm	Ø 10 mm
5918000	...591806	1 diamond drill "Ceramic"	Ø 10 mm	30 mm	Ø 10 mm



- for diamond drills Ceramic Ø 5 - 10 mm
- integrated water cooling due to a sponge
- the diamond drill does not slide while drilling
- two suction cups ensure safe drilling in floor tiles, stoneware and granite plates
- packaging: fixed on card
- suitable for 5915000, 5916000, 5917000, 5918000

article no.	EAN 4006885...	description	Ø	version
5911000	...591103	1 guide	Ø 10 mm	with 2 suction cups

POWER TOOL ACCESSORIES 6

6.2 Hole saws / Annular bits



- content:
4 diamond drills, ø 5, 6, 8, 10 mm
1 guide, with 2 suction cups
- in plastic box
- packaging: sticker

article no.	EAN	description
8771000	4006885... ...877108	1 diamond drill set

"Ceramic" diamond hole saws for cordless screwdrivers



Secondary placement product for tile department. Packaging with user-oriented communication.

- machine: cordless screwdrivers
- for sockets to be installed on tiles
- for tiles, fine stoneware, granite plates, glazed tiles
- with centring drill - does not require any additional drilling aid
- sawing edge coated with quality industrial diamonds which even drill through the hardest materials
- main body turned out of solid material - for permanent precision work
- the sponge provided facilitates the cooling with water which will increase the lifetime and prevent the dust formation while drilling
- packaging: double blister
- separate accessories: 5913000

article no.	EAN	description	Ø	cutting depth	shank
8911000	4006885... ...891104	1 diamond hole saw "Ceramic"	ø 68 mm	25 mm	ø 10 mm

6 POWER TOOL ACCESSORIES

6.2 Hole saws / Annular bits



- machine: cordless screwdrivers
- applicable for attachments for sanitarian equipment, holes for sockets, down pipes, heater lines, floor spots and water connections
- for tiles, fine stoneware, granite plates, glazed tiles
- with centring drill - does not require any additional drilling aid
- sawing edge coated with quality industrial diamonds which even drill through the hardest materials
- main body turned out of solid material - for permanent precision work
- the sponge provided facilitates the cooling with water which will increase the lifetime and prevent the dust formation while drilling
- in storage box
- packaging: sticker
- separate accessories: 5913000

article no.	EAN 4006885...	description	Ø	cutting depth	shank
5920000	...592001	1 diamond hole saw "Ceramic"	Ø 18 mm	45 mm	Ø 10 mm
5922000	...592209	1 diamond hole saw "Ceramic"	Ø 22 mm	45 mm	Ø 10 mm
5924000	...592407	1 diamond hole saw "Ceramic"	Ø 25 mm	45 mm	Ø 10 mm
5926000	...592605	1 diamond hole saw "Ceramic"	Ø 35 mm	45 mm	Ø 10 mm
5928000	...592803	1 diamond hole saw "Ceramic"	Ø 45 mm	45 mm	Ø 10 mm
5929000	...592902	1 diamond hole saw "Ceramic"	Ø 53 mm	45 mm	Ø 10 mm
5940000	...594005	1 diamond hole saw "Ceramic"	Ø 60 mm	45 mm	Ø 10 mm
5930000	...593008	1 diamond hole saw "Ceramic"	Ø 65 mm	45 mm	Ø 10 mm
5931000	...593107	1 diamond hole saw "Ceramic"	Ø 68 mm	45 mm	Ø 10 mm
5932000	...593206	1 diamond hole saw "Ceramic"	Ø 74 mm	45 mm	Ø 10 mm
5933000	...593305	1 diamond hole saw "Ceramic"	Ø 83 mm	45 mm	Ø 10 mm

6.2 Hole saws / Annular bits

"Ceramic" diamond hole saws for angle grinders



- machine: one-hand angle grinders
- applicable for attachments for sanitarian equipment, holes for sockets, down pipes, heater lines, floor spots and water connections
- for tiles, fine stoneware, granite plates, glazed tiles
- sawing edge coated with quality industrial diamonds which even drill through the hardest materials
- packaging: fixed on card

article no.	EAN	description	version	Ø	cutting depth
5995000	...599505	1 diamond hole saw "Ceramic"	thread M 14	ø 5 mm	35 mm
5996000	...599604	1 diamond hole saw "Ceramic"	thread M 14	ø 6 mm	35 mm
5997000	...599703	1 diamond hole saw "Ceramic"	thread M 14	ø 8 mm	35 mm
5998000	...599802	1 diamond hole saw "Ceramic"	thread M 14	ø 10 mm	35 mm
5999000	...599901	1 diamond hole saw "Ceramic"	thread M 14	ø 14 mm	35 mm
5941000	...594104	1 diamond hole saw "Ceramic"	thread M 14	ø 20 mm	45 mm
5942000	...594203	1 diamond hole saw "Ceramic"	thread M 14	ø 25 mm	45 mm
5943000	...594302	1 diamond hole saw "Ceramic"	thread M 14	ø 35 mm	45 mm
5944000	...594403	1 diamond hole saw "Ceramic"	thread M 14	ø 40 mm	45 mm
5945000	...594500	1 diamond hole saw "Ceramic"	thread M 14	ø 45 mm	45 mm
5946000	...594609	1 diamond hole saw "Ceramic"	thread M 14	ø 50 mm	45 mm
5947000	...594708	1 diamond hole saw "Ceramic"	thread M 14	ø 54 mm	45 mm
5948000	...594807	1 diamond hole saw "Ceramic"	thread M 14	ø 60 mm	45 mm
5949000	...594906	1 diamond hole saw "Ceramic"	thread M 14	ø 68 mm	45 mm

Accessories



- machine: cordless screwdrivers
- Spare part for diamond hole saws "Ceramic"
- packaging: blister on card
- suitable for 5920000, 5922000, 5924000, 5926000, 5928000, 5929000, 5930000, 5931000, 5932000, 5933000, 5940000, 5981000, 8911000

article no.	EAN	description	version
5913000	...591301	1 centring drill unit	tungsten carbide tipped

6 POWER TOOL ACCESSORIES

6.2 Hole saws / Annular bits

Assortments



- for drilling holes for sockets
- suitable for all common socket combinations
- for tiles, fine stoneware, granite plates, wood, metal, plastic material
- content:
 - 1 diamond hole saw "Ceramic", \varnothing 68 mm, tiles, fine stoneware, granite plates, glazed tiles
 - 1 hole saw, BiM, \varnothing 68 mm, wood, steel, plastic materials, gypsum plaster boards
 - 1 template, suitable for all common socket combinations
- in plastic case
- separate accessories: 5913000

article no.	EAN	description	\varnothing
5981000	4006885... ...598102	1 hole saw set "sanitary"	\varnothing 68 mm

Hole cutters for water taps



- for water taps
- simple and exact punching
- for sheet steel, stainless steel
- the work requires a slight effort only thanks to the ball bearing
- high durability
- including: 1 screw starter, \varnothing 10.2 mm
- in storage box
- packaging: sticker

article no.	EAN	description	version	\varnothing
3761000	4006885... ...376106	1 hole cutter	with ball bearing	\varnothing 32 mm (1 1/4")
3762000	...376205	1 hole cutter	with ball bearing	\varnothing 35 mm (1 3/8")

POWER TOOL ACCESSORIES

6.2 Hole saws / Annular bits

6



Secondary placement product for sink department.

- for water taps
- simple and exact punching
- for sheet steel, stainless steel
- content:
 - 1 hole cutter, \varnothing 35 mm
 - 2 HSS Metal drills rolled, \varnothing 4, 10 mm
- packaging: sliding blister

article no.	EAN	description	\varnothing
8925000	...892507	1 hole cutter set	\varnothing 35 mm (1 3/8")



- for water taps
- simple and exact punching
- for sheet steel, stainless steel
- packaging: storage box on card

article no.	EAN	description	\varnothing
3752000	...375208	1 hole cutter	\varnothing 28 mm (1 1/8")
3753000	...375307	1 hole cutter	\varnothing 32 mm (1 1/4")
3754000	...375406	1 hole cutter	\varnothing 35 mm (1 3/8")
3756000	...375604	1 hole cutter	\varnothing 40 mm (1 4/7")



- especially for installation of water taps in fibre glass reinforced plastic sinks (GFK)
- packaging: storage box on card

article no.	EAN	description	\varnothing	shank
3759000	...375901	1 special drill	\varnothing 28, 32, 35 mm	\varnothing 10 mm

6 POWER TOOL ACCESSORIES

6.2 Hole saws / Annular bits

Miscellaneous



- for halogen lamps
- especially suitable for high-voltage halogen lamps (e.g. GU 10)
- for the speedy and easy change of halogen light bulbs
- avoids damage to the halogen lamp from touching it with bare fingers
- packaging: fixed on card

article no.	EAN	description
5499000	4006885... ...549906	1 suction cup

6.3 Bits/ Handscrewdrivers/ Holders/ Adapters



6.3 Bits/ Handscrewdrivers/ Holders/ Adapters

Solid bits

- special shot-blasted surface
- exact fitting point
- tough and hard tool
- small tolerances

Standard bits 25 mm

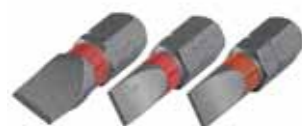

article no.	EAN 4006885...	description	type	blade size / width	length	packaging
1338000	...133808	3 bits	flat	0.8 x 5.5 mm 1 x 5.5 mm 1.2 x 6.5 mm	25 mm	blister on card



article no.	EAN 4006885...	description	type	size	length	packaging
1330000	...133006	3 bits	Phillips	PH 1	25 mm	blister on card
1330099	...011663	1 bit	Phillips	PH 1	25 mm	bulk
1331000	...133105	3 bits	Phillips	PH 2	25 mm	blister on card
1527000	...152700	6 bits	Phillips	PH 2	25 mm	blister on card
1331099	...011670	1 bit	Phillips	PH 2	25 mm	bulk
1332000	...133204	3 bits	Phillips	PH 3	25 mm	blister on card
1332099	...011687	1 bit	Phillips	PH 3	25 mm	bulk



article no.	EAN 4006885...	description	type	size	length	packaging
1333000	...133303	3 bits	Pozidriv	PZ 1	25 mm	blister on card
1333099	...011694	1 bit	Pozidriv	PZ 1	25 mm	bulk
1334000	...133402	3 bits	Pozidriv	PZ 2	25 mm	blister on card
1534000	...153400	6 bits	Pozidriv	PZ 2	25 mm	blister on card
1334099	...011700	1 bit	Pozidriv	PZ 2	25 mm	bulk
1335000	...133501	3 bits	Pozidriv	PZ 3	25 mm	blister on card
1335099	...011717	1 bit	Pozidriv	PZ 3	25 mm	bulk
2443000	...244306	1 bit	Pozidriv	PZ 4	25 mm	blister on card

6.3 Bits/ Handscrewdrivers/ Holders/ Adapters



article no.	EAN 4006885...	description	type	size	length	packaging
2480000	...248007	3 bits	Torx	TX 10	25 mm	blister on card
2480099	...011724	1 bit	Torx	TX 10	25 mm	bulk
2477000	...247703	3 bits	Torx	TX 15	25 mm	blister on card
2477099	...011731	1 bit	Torx	TX 15	25 mm	bulk
2481000	...248106	3 bits	Torx	TX 20	25 mm	blister on card
2481099	...011748	1 bit	Torx	TX 20	25 mm	bulk
2478000	...247802	3 bits	Torx	TX 25	25 mm	blister on card
2478099	...011755	1 bit	Torx	TX 25	25 mm	bulk
2479000	...247901	3 bits	Torx	TX 27	25 mm	blister on card
2482000	...248205	3 bits	Torx	TX 30	25 mm	blister on card
2482099	...011762	1 bit	Torx	TX 30	25 mm	bulk
2483000	...248304	3 bits	Torx	TX 40	25 mm	blister on card
2483099	...011779	1 bit	Torx	TX 40	25 mm	bulk
2416000	...241602	1 bit	Torx	TX 50	25 mm	blister on card
2491000	...249103	2 bits	Torx	TX 6 - 7	25 mm	blister on card
2495000	...249509	2 bits	Torx	TX 8 - 9	25 mm	blister on card
2447000	...244702	7 bits	Torx	TX 10 - 15 - 20 - 25 - 27 - 30 - 40	25 mm	blister on card



article no.	EAN 4006885...	description	type	size	length	packaging
1209000	...120907	2 bits	Torx	TX 10	25 mm	blister on card
1210000	...121003	2 bits	Torx	TX 15	25 mm	blister on card
1211000	...121102	2 bits	Torx	TX 20	25 mm	blister on card
1212000	...121201	2 bits	Torx	TX 25	25 mm	blister on card
1213000	...121300	2 bits	Torx	TX 30	25 mm	blister on card



article no.	EAN 4006885...	description	type	size	length	packaging
1339000	...133907	3 bits	hexagonal	2 - 2.5 - 3	25 mm	blister on card
1340000	...134003	3 bits	hexagonal	4 - 5 - 6	25 mm	blister on card

6 POWER TOOL ACCESSORIES

6.3 Bits/ Handscrewdrivers/ Holders/ Adapters

Assortments



easily to open or close

Ready after one grip

- the integrated magnetic strip prevents bits from falling out
- opens with one hand, the BitButler contains a neat assortment, when folded it will fit in any shirt pocket
- in storage box
- packaging: blister on card



article no.	EAN 4006885...	description	content	length
1369000	...136908	1 BitButler 9-piece	4 Phillips PH 1 - PH 2 - PH 2 - PH 3 4 Pozidriv PZ 1 - PZ 2 - PZ 2 - PZ 3 1 bit holder, magnetic	25 mm
1372000	...137202	1 BitButler 11-piece	10 Torx TX 7 - TX 8 - TX 9 - TX 10 - TX 15 - TX 20 - TX 25 - TX 27 - TX 30 - TX 40 1 bit holder, magnetic	25 mm
1374000	...137400	1 BitButler 21-piece	3 flat, 0.6 x 4.5 mm, 0.8 x 5.5 mm, 1.2 x 6.5 mm 3 Phillips PH 1 - PH 2 - PH 3 3 Pozidriv PZ 1 - PZ 2 - PZ 3 7 Torx TX 7 - TX 8 - TX 9 - TX 10 - TX 15 - TX 20 - TX 25 4 hexagonal 2 - 2.5 - 3 - 4 1 bit holder, magnetic	25 mm



- with the most common drives for work in and around the house
- including belt clip
- in 2-component plastic box with lid
- packaging: double card with inlaid blister



article no.	EAN 4006885...	description	content	length
2975000	...297500	1 bit box 32 pieces	4 flat, 0.6 x 4.5 mm, 0.8 x 5.5 mm, 1 x 5.5 mm, 1.2 x 6.5 mm 4 Phillips PH 1 - PH 2 - PH 2 - PH 3 4 Pozidriv PZ 1 - PZ 2 - PZ 2 - PZ 3 14 Torx TX 6 - TX 7 - TX 8 - TX 9 - TX 10 - TX 10 - TX 15 - TX 15 - TX 20 - TX 20 - TX 25 - TX 25 - TX 30 - TX 40 5 hexagonal 2 - 3 - 4 - 5 - 6 1 bit holder, magnetic	25 mm

6.3 Bits/ Handscrewdrivers/ Holders/ Adapters



- easy removal of bits - anyway safe hold in the box
- small and handy
- good haptis - cover out of 2-components
- in 2-component plastic box with lid
- packaging: blister on card



article no.	EAN	description	content	length
2976000	4006885... ...297609	1 bit box 7 pieces	6 Phillips PH 1 - PH 1 - PH 2 - PH 2 - PH 3 1 bit holder, magnetic	25 mm
2977000	...297708	1 bit box 7 pieces	6 Pozidriv PZ 1 - PZ 1 - PZ 2 - PZ 2 - PZ 3 1 bit holder, magnetic	25 mm
2978000	...297807	1 bit box 7 pieces	6 Torx TX 10 - TX 15 - TX 20 - TX 20 - TX 25 - TX 25 1 bit holder, magnetic	25 mm
2979000	...297906	1 bit box 7 pieces	1 Phillips PH 2 1 Pozidriv PZ 2 4 Torx TX 10 - TX 15 - TX 20 - TX 25 1 bit holder, magnetic	25 mm
2980000	...298002	1 bit box 7 pieces	6 flat, 0.6 x 4.5 mm, 0.8 x 5.5 mm, 0.8 x 5.5 mm, 1 x 5.5 mm, 1 x 5.5 mm, 1.2 x 6.5 mm 1 bit holder, magnetic	25 mm



- easy removal of bits - anyway safe hold in the box
- small and handy
- in plastic box
- packaging: blister on card

article no.	EAN	description	content	length
1216000	4006885... ...121607	1 bit box 7 pieces	6 Torx TX 10 - TX 15 - TX 20 - TX 20 - TX 25 - TX 30 1 bit holder, magnetic	25 mm



- in high-quality storage box
- in 2-component plastic box with lid



article no.	EAN	description	content	length
8633000	4006885... ...863309	1 bit box 17-piece	3 flat, 0.6 x 4.5 mm, 1 x 5.5 mm, 1.6 x 8 mm 4 Phillips PH 1 - PH 2 - PH 2 - PH 3 4 Pozidriv PZ 1 - PZ 2 - PZ 2 - PZ 3 5 Torx TX 10 - TX 20 - TX 25 - TX 30 - TX 40 1 bit holder, magnetic	25 mm

6 POWER TOOL ACCESSORIES

6.3 Bits/ Handscrewdrivers/ Holders/ Adapters



• in plastic cassette



article no.	EAN	description	content	length
2400000	4006885... ...240001	1 bit box 16-piece	3 flat, 0.6 x 4.5 mm, 1 x 5.5 mm, 1.6 x 8 mm 4 Phillips PH 1 - PH 2 - PH 2 - PH 3 4 Pozidriv PZ 1 - PZ 2 - PZ 2 - PZ 3 4 Torx TX 10 - TX 20 - TX 25 - TX 30 1 bit holder, magnetic	25 mm



• in plastic box



article no.	EAN	description	content	length
1575000	4006885... ...157507	1 bit box 10-piece	3 flat, 0.6 x 4.5 mm, 0.8 x 5.5 mm, 1 x 5.5 mm 3 Phillips PH 1 - PH 2 - PH 3 3 Pozidriv PZ 1 - PZ 2 - PZ 3 1 bit holder, magnetic	25 mm



The well-priced set for experts

- for all repairs in and around the house
- with all common bit types
- in metal cassette
- packaging: blister on card

article no.	EAN	description	content	length
1388000	4006885... ...138803	1 bit box 32 pieces	4 flat, 0.6 x 4 mm, 0.8 x 5 mm, 1 x 3 mm, 1 x 6 mm 4 Phillips PH 1 - PH 2 - PH 2 - PH 3 4 Pozidriv PZ 1 - PZ 2 - PZ 2 - PZ 3 7 Torx TX 10 - TX 15 - TX 20 - TX 25 - TX 27 - TX 30 - TX 40 7 Torx with hole TX 10 - TX 15 - TX 20 - TX 25 - TX 27 - TX 30 - TX 40 4 hexagonal 3 - 4 - 5 - 6 1 hand screwdriver, 2-component handle 1 adapter	25 mm

6.3 Bits/ Handscrewdrivers/ Holders/ Adapters



2445000

2446000

2444000

- packaging: blister on card



article no.	EAN 4006885...	description	content	length
2445000	...244504	1 bit set 12-piece	5 flat, 0.6 x 4.5 mm, 0.8 x 5.5 mm, 1 x 5.5 mm, 1.2 x 6.5 mm, 1.6 x 8 mm 3 Phillips PH 1 - PH 2 - PH 3 3 Pozidriv PZ 1 - PZ 2 - PZ 3 1 bit holder, magnetic	25 mm
2446000	...244603	1 bit set 7 pieces	2 flat, 1 x 5.5 mm, 1.2 x 6.5 mm 2 Phillips PH 1 - PH 2 2 Pozidriv PZ 1 - PZ 2 1 bit holder, magnetic	25 mm
2444000	...244405	1 bit set 6-piece	2 flat, 1 x 5.5 mm, 1.2 x 6.5 mm 2 Phillips PH 1 - PH 2 2 Pozidriv PZ 1 - PZ 2	25 mm

Bits for interior works 25 mm



- for gypsum plaster boards, wood panels, chipboards
- with pressed-on depth stop for secure and fast screwing
- packaging: blister on card



article no.	EAN 4006885...	description	type	size	version	length
1342000	...134201	2 bits interior works	Phillips	PH 2	with depth stop	25 mm
1344000	...134409	2 bits interior works	Pozidriv	PZ 2	with depth stop	25 mm

6 POWER TOOL ACCESSORIES

6.3 Bits/ Handscrewdrivers/ Holders/ Adapters

Safety bits



• packaging: blister on card



article no.	EAN 4006885...	description	type	size	length
1260000	...126008	3 screwdriver blades	Torx with hole	TX 7 - 8 - 9	50 mm
1261000	...126107	3 screwdriver blades	Torx with hole	TX 10 - 15 - 20	50 mm
1262000	...126206	3 screwdriver blades	Torx with hole	TX 25 - 27 - 30	50 mm
1263000	...126305	3 screwdriver blades	hexagonal with hole	2 - 2.5 - 3	50 mm
1264000	...126404	3 screwdriver blades	hexagonal with hole	4 - 5 - 6	50 mm
1265000	...126503	3 screwdriver blades	Spanner	4 - 6 - 8	50 mm
1266000	...126602	3 screwdriver blades	Square Plus	1 - 2 - 3	50 mm
1267000	...126701	3 screwdriver blades	Torq-Set	6 - 8 - 10	50 mm
1268000	...126800	3 screwdriver blades	Tri-Wing	1 - 2 - 3	50 mm
1269000	...126909	3 screwdriver blades	Clutch	1 - 2 - 3	50 mm



- for the repair of most of the commercially available electrical equipment, computers etc.
- in metal cassette
- packaging: blister on card



article no.	EAN 4006885...	description	content
1386000	...138605	1 combi safety bit box 31 pieces	3 Square plus, 25 mm, 0 - 1 - 2 3 Phillips, 25 mm, 1 - 2 - 3 5 hexagonal with hole, 25 mm, 2 - 2.5 - 3 - 4 - 5 4 Torx with hole, 25 mm, 6 - 7 - 8 - 9 3 Tri-Wing, 50 mm, 1 - 2 - 3 3 Torq, 50 mm, 6 - 8 - 10 3 Spanner, 50 mm, 4 - 6 - 8 6 Torx with hole, 50 mm, 10 - 15 - 20 - 25 - 27 - 30 1 hand screwdriver, 2-component handle

6.3 Bits/ Handscrewdrivers/ Holders/ Adapters



The well-priced set for experts

- for all difficult jobs
- for areas difficult to access
- in metal cassette
- packaging: blister on card

article no.	EAN	description	content	length
1389000	4006885... ...138902	1 micro bit box 32 pieces	7 flat, 28 mm, 1 - 1.5 - 2 - 2.5 - 3 - 3.5 - 4 4 Phillips, 28 mm, 000 - 00 - 0 - 1 2 Pozidriv, 28 mm, 0 - 1 9 Torx, 28 mm, 4 - 5 - 6 - 7 - 8 - 9 - 10 - 15 - 20 8 hexagonal, 28 mm, 0.7 - 0.9 - 1.3 - 1.5 - 2 - 2.5 - 3 - 4 1 hand screwdriver, 2-component handle 1 extension shank	28 mm

Double bits 60 mm

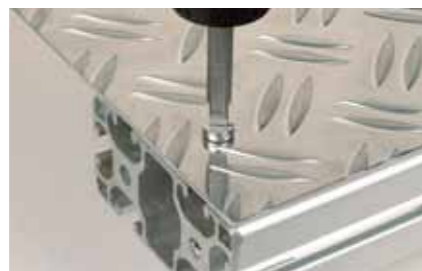

- packaging: blister on card

article no.	EAN	description	size	length
2407000	4006885... ...240704	2 double bits	Phillips PH 1 / flat, 0.6 x 4.5 mm Phillips PH 2 / flat, 0.8 x 5.5 mm	60 mm
2408000	4006885... ...240803	2 double bits	Pozidriv PZ 1 / flat, 0.6 x 4.5 mm Pozidriv PZ 2 / flat, 0.8 x 5.5 mm	60 mm

6.3 Bits/ Handscrewdrivers/ Holders/ Adapters

Screwdriver blades 89 mm

– very long blade for use in narrow working spaces



• packaging: blister on card



article no.	EAN 4006885...	description	type	blade size / width	length
1252000	...125209	1 screwdriver blade	flat	0.6 x 4.5 mm	89 mm
1253000	...125308	1 screwdriver blade	flat	1 x 5.5 mm	89 mm



• packaging: blister on card



article no.	EAN 4006885...	description	type	size	length
1241000	...124103	1 screwdriver blade	Phillips	PH 1	89 mm
1242000	...124202	1 screwdriver blade	Phillips	PH 2	89 mm



• packaging: blister on card



article no.	EAN 4006885...	description	type	size	length
1244000	...124400	1 screwdriver blade	Pozidriv	PZ 1	89 mm
1245000	...124509	1 screwdriver blade	Pozidriv	PZ 2	89 mm



• packaging: blister on card



article no.	EAN 4006885...	description	type	size	length
1247000	...124707	1 screwdriver blade	Torx	TX 10	89 mm
1248000	...124806	1 screwdriver blade	Torx	TX 15	89 mm
1249000	...124905	1 screwdriver blade	Torx	TX 20	89 mm
1250000	...125001	1 screwdriver blade	Torx	TX 25	89 mm

6.3 Bits/ Handscrewdrivers/ Holders/ Adapters

Miscellaneous



- machine: cordless screwdrivers and hand screwdrivers
- for removing screws with defect drive
- size SR 2 for screws with drive PH 1, PZ 1, TX 10, hexagon 2.5 + 3, SL 0.8 x 5.5 mm
- size SR 2 for screws with drive PH 2, PZ 2, TX 15 + 20, hexagon 4
- packaging: blister on card

article no.	EAN	description	
2982000	4006885... ...298200	2 screw removers	

Torsion solid bits 25 mm

- S2 steel, high-quality forged material
- Torsion zone for maximum torques
- lowest tolerances for direct force transmission
- long life
- fix grip thanks to additional ribs - extreme grip
- ideal for all interior work



- good haptis - cover out of 2-components
- in 2-component plastic box with lid
- packaging: blister on card



article no.	EAN	description	content	length
2965000	4006885... ...296503	1 Torx FIX-GRIP - bit box 7 pieces	6 Torx FIX-GRIP, 25 mm, 10 - 15 - 20 - 25 - 30 - 40 1 bit holder, magnetic	25 mm

6.3 Bits/ Handscrewdrivers/ Holders/ Adapters

Torsion TiN bits 25 mm

- TiN coating for high wear-resistance
- tough annealed core with high elasticity
- low risk of breakage
- torsion zone for receptacle of peak forces
- applicational versatility



article no.	EAN 4006885...	description	type	blade size / width	length	packaging
1320000	...132009	2 bits	flat	0.8 x 5.5 mm 1.2 x 6.5 mm	25 mm	blister on card



article no.	EAN 4006885...	description	type	size	length	packaging
1322000	...132207	2 bits	Phillips	PH 1	25 mm	blister on card
1322099	...011038	1 bit	Phillips	PH 1	25 mm	bulk
1323000	...132306	2 bits	Phillips	PH 2	25 mm	blister on card
1323099	...011045	1 bit	Phillips	PH 2	25 mm	bulk
1324000	...132405	2 bits	Phillips	PH 3	25 mm	blister on card
1324099	...011052	1 bit	Phillips	PH 3	25 mm	bulk



article no.	EAN 4006885...	description	type	size	length	packaging
1325000	...132504	2 bits	Pozidriv	PZ 1	25 mm	blister on card
1325099	...011069	1 bit	Pozidriv	PZ 1	25 mm	bulk
1326000	...132603	2 bits	Pozidriv	PZ 2	25 mm	blister on card
1326099	...011076	1 bit	Pozidriv	PZ 2	25 mm	bulk
1327000	...132702	2 bits	Pozidriv	PZ 3	25 mm	blister on card
1327099	...011083	1 bit	Pozidriv	PZ 3	25 mm	bulk



article no.	EAN 4006885...	description	type	size	length	packaging
1317099	...131705	1 bit	Torx	TX 10	25 mm	bulk
1319099	...131903	1 bit	Torx	TX 15	25 mm	bulk
1321099	...132108	1 bit	Torx	TX 20	25 mm	bulk
1328099	...132801	1 bit	Torx	TX 25	25 mm	bulk
1329099	...132900	1 bit	Torx	TX 30	25 mm	bulk



6.3 Bits/ Handscrewdrivers/ Holders/ Adapters



article no.	EAN 4006885...	description	type	size	length	packaging
1315099	...131507	1 bit	Torx	TX 40	25 mm	bulk

Diamond bits 25 mm

- professional quality
- diamond particles maximize the grip of the bit
- reduced wear of bit and screw head
- up to 10 times the durability of Solid-bits
- low risk of breakage
- torsion zone for the absorption of peak forces, extreme torques will be absorbed



article no.	EAN 4006885...	description	type	size	length	packaging
1305000	...130500	1 bit	Phillips	PH 1	25 mm	blister on card
1306000	...130609	1 bit	Phillips	PH 2	25 mm	blister on card
1307000	...130708	1 bit	Phillips	PH 3	25 mm	blister on card



article no.	EAN 4006885...	description	type	size	length	packaging
1302000	...130203	1 bit	Pozidriv	PZ 1	25 mm	blister on card
1303000	...130302	1 bit	Pozidriv	PZ 2	25 mm	blister on card
1304000	...130401	1 bit	Pozidriv	PZ 3	25 mm	blister on card



article no.	EAN 4006885...	description	type	size	length	packaging
1296000	...129603	1 bit	Torx	TX 10	25 mm	blister on card
1297000	...129702	1 bit	Torx	TX 15	25 mm	blister on card
1298000	...129801	1 bit	Torx	TX 20	25 mm	blister on card
1299000	...129900	1 bit	Torx	TX 25	25 mm	blister on card

6 POWER TOOL ACCESSORIES

6.3 Bits/ Handscrewdrivers/ Holders/ Adapters



- easy removal of bits - anyway safe hold in the box
- with colour code for drive
- small and handy
- good haptis - cover out of 2-components
- in 2-component plastic box with lid
- packaging: blister on card



article no.	EAN	description	content	length
2963000	4006885... ...296305	1 bit box 7 pieces	3 Phillips PH 1 - PH 2 - PH 3 3 Pozidriv PZ 1 - PZ 2 - PZ 3 1 bit holder, magnetic	25 mm
2964000	...296404	1 bit box 7 pieces	6 Torx TX 10 - TX 15 - TX 20 - TX 20 - TX 25 - TX 30 1 bit holder, magnetic	25 mm

Impact bits 25 mm

- professional quality
- specially hardened
- for toughest impact bits with cordless impact screwdriver
- lowest tolerances for direct force transmission



- easy removal of bits - anyway safe hold in the box
- with colour code for drive
- small and handy
- good haptis - cover out of 2-components
- in 2-component plastic box with lid
- packaging: blister on card

article no.	EAN	description	content	length
2969000	4006885... ...296909	1 Impact - bit box 7 pieces	6 Torx TX 15 - TX 20 - TX 20 - TX 25 - TX 25 - TX 30 1 bit holder	25 mm
2974000	...297401	1 Impact - bit box 7 pieces	3 Phillips PH 1 - PH 2 - PH 3 3 Pozidriv PZ 1 - PZ 2 - PZ 3 1 bit holder	25 mm

6.3 Bits/ Handscrewdrivers/ Holders/ Adapters

Hand screwdrivers

You will find a suitable screwdriver for any application in the wolcraft range of manual screwdrivers, be it for more or less space or power. The ergonomic handles are very comfortable to hold and will ensure the optimal transmission of power.



- for standard applications in large, wide spaces with much room for movement
- 2-component handle
- packaging: fixed on card

article no.	EAN	description	version	receptacle	length
8725000	4006885... ...872509	1 hand screwdriver	long, with magnet and quick-change chuck	6,3 mm (1/4") hexagon receptacle	197 mm



- for working in narrow, cramped spaces
- optimal use with long bits
- 2-component handle
- packaging: fixed on card

article no.	EAN	description	version	receptacle	length
1240000	4006885... ...124004	1 hand screwdriver	medium, with magnet and quick-change chuck	6,3 mm (1/4") hexagon receptacle	138 mm



- ideal for small gaps and inaccessible sites
- the ergonomic grip will secure a high degree of power transmission
- 2-component handle
- packaging: fixed on card

article no.	EAN	description	version	receptacle	length
1239000	4006885... ...123908	1 hand screwdriver	short, with magnet and quick-change chuck	6,3 mm (1/4") hexagon receptacle	76 mm

6 POWER TOOL ACCESSORIES

6.3 Bits/ Handscrewdrivers/ Holders/ Adapters



- T-handle for high torque
- requires a minimum of power only, even for tight screws, thanks to the excellent power transmission
- working comfortably in any position, even over head
- 2-component handle
- packaging: fixed on card

article no.	EAN	description	version	receptacle	length
1235000	4006885... ...123502	1 T-hand screwdriver	with magnet	6,3 mm (1/4") hexagon receptacle	152 mm



The only hand screwdriver for curves!

- for areas difficult to access
- with holding ring for a precise guide of the hand screwdriver
- the ergonomic grip will secure a high degree of power transmission
- 2-component handle
- packaging: fixed on card

article no.	EAN	description	version	receptacle	length
1236000	4006885... ...123601	1 hand screwdriver	with flexible shaft, with magnet	6,3 mm (1/4") hexagon receptacle	289 mm



- for drilling and screwing at an angle of 90° angle in tight places
- the corner dimension is only 50 mm including a 25 mm bit
- packaging: blister on card

article no.	EAN	description	receptacle	length
1573000	4006885... ...157309	1 angled hand screwdriver	double-sided receptacle for 6,3 mm (1/4") hexagon bits	109 mm

6.3 Bits/ Handscrewdrivers/ Holders/ Adapters



- for hooks and eyebolts with a head width of up to 6 mm
- the handle with the hexagon receptacle is removable and can be used as manual screwdriver for bits, sockets, taps or countersinks
- minimal force
- working comfortably in any position, even over head
- the head can also be used in a cordless power drill with a maximum speed of 25 rpm
- packaging: fixed on card

article no.	EAN	description	version	receptacle	length
2419000	4006885... ...241909	1 hook screwdriver	with bit receptacle	6,3 mm (1/4") hexagon receptacle	104 mm



The mini-hand screwdriver with ratchet - ideal for every household!

- for working comfortably in narrow spaces
- for small repairing jobs, to bolt loose screws etc.
- assembled with 5 bits at the magazine - directly applicable
- with reversing switch for right and left rotation
- 2-component handle
- including:
 - 2 bits, slot 0,6 x 4,5 mm - 1,0 x 5,5 mm
 - 3 bits, Phillips PH 1 - 2 - 3
- packaging: double blister

article no.	EAN	description	version	receptacle	length
1237000	4006885... ...123700	1 miniature hand screwdriver	with ratchet, with magnet	6,3 mm (1/4") hexagon receptacle	116 mm

6.3 Bits/ Handscrewdrivers/ Holders/ Adapters

Bit Holders / Adapters

Bit holders



- machine: cordless screwdrivers and power drills
- the permanent magnet retains bit and screw
- receptacle: 6,3 mm (1/4") hexagon receptacle

article no.	EAN	description	version	length	packaging
1577000	...157705	1 bit holder	with magnet	50 mm	blister on card
2426000	...242609	1 bit holder	with magnet	60 mm	blister on card
2426099	...011786	1 bit holder	with magnet	60 mm	bulk



- machine: cordless screwdrivers and power drills
- for holding a wide variety of tools and restricted-depth drilling
- receptacle: 6,3 mm (1/4") hexagon receptacle
- shank: hexagon shank 1/4" (6,35 mm)



article no.	EAN	description	version	length	packaging
1539000	...153905	1 bit holder with depth stop	with magnet and fixing screw	60 mm	blister on card



- machine: cordless screwdrivers and power drills
- strong permanent magnet retains bit and screw
- receptacle: 6,3 mm (1/4") hexagon receptacle

article no.	EAN	description	version	length	packaging
2421000	...242104	1 bit holder	with magnet and quick-change chuck	52 mm	blister on card

POWER TOOL ACCESSORIES

6

6.3 Bits/ Handscrewdrivers/ Holders/ Adapters



- machine: cordless screwdrivers and power drills
- the permanent magnet retains bit and screw
- receptacle: 6,3 mm (1/4") hexagon receptacle

article no.	EAN	description	version	length	packaging
2425000	4006885... ...242500	1 bit holder	with magnet and and depth stop	72 mm	blister on card



- machine: cordless screwdrivers and power drills
- strong permanent magnet retains bit and screw
- receptacle: 6,3 mm (1/4") hexagon receptacle

article no.	EAN	description	version	length	packaging
2411000	4006885... ...241107	1 bit holder	with magnet and depth stop with ring magnet	60 mm	blister on card



- machine: cordless screwdrivers and power drills
- the permanent magnet retains bit and screw
- the ring-type magnet retains screws
- receptacle: 6,3 mm (1/4") hexagon receptacle

article no.	EAN	description	version	length	packaging
2983000	4006885... ...298309	1 bit holder	with magnet and ring magnet	150 mm	fixed on card
2981000	...298101	1 bit holder	with magnet and ring magnet	250 mm	fixed on card
2984000	...298408	1 bit holder	with magnet and ring magnet	300 mm	fixed on card
2985000	...298507	1 bit holder	with magnet and ring magnet	450 mm	fixed on card



- machine: cordless screwdrivers and power drills
- strong permanent magnet retains bit and screw
- quick-lock system permits fast, convenient drive changes
- receptacle: 6,3 mm (1/4") hexagon receptacle

article no.	EAN	description	version	packaging
2986099	4006885... ...298699	1 bit holder "Quick-Lock"	with magnet	bulk

6 POWER TOOL ACCESSORIES

6.3 Bits/ Handscrewdrivers/ Holders/ Adapters



- machine: hammer drills with SDS-plus holder
- the permanent magnet retains bit and screw
- receptacle: 6,3 mm (1/4") hexagon receptacle
- shank: SDS-plus

article no.	EAN	description	version	length	packaging
2429000	4006885... ...242906	1 bit holder	with magnet and snap ring	80 mm	blister on card



- machine: cordless screwdrivers and power drills
- dual quick change holder solution for drilling, countersinking and screwing
- two-sided tool holder suitable for 1/4" hexagonal tools
- ideal for operations involving multiple stages
- bit holder for tool changes in a matter of seconds by turning the tool holder
- content:
 - 1 receptacle for dual quick change holder, with triangular shank
 - 1 dual quick change holder
 - 1 screw starters with countersink
 - 1 bit, Torx TX 25
 - 1 hexagonal key, SW 2
- separate accessories: 3083000, 3084000, 3085000

article no.	EAN	description	version	packaging
3082000	4006885... ...308206	1 flipbit starter set 4-piece	with magnet and fixing screw	blister on card



- with magnet and fixing screw
- suitable for 3082000

article no.	EAN	description	packaging
3084000	4006885... ...308404	2 dual quick change holders for flipbit	blister on card

6.3 Bits/ Handscrewdrivers/ Holders/ Adapters



- for equipping the flipbit dual tool holder
- shank: hexagon shank 1/4" (6,35 mm)
- content:
 - 3 metal drills, ø 2, 3, 4 mm, short
 - 2 bits, Phillips PH 1 - 2
 - 2 bits, Pozidriv PZ 1 - 2
 - 2 bits, Torx TX 15 - 20
- suitable for 3082000

article no.	EAN	description	packaging
3083000	4006885... ...308305	1 flipbit set for screwing 9-piece	blister on card



- for equipping the flipbit dual tool holder
- shank: hexagon shank 1/4" (6,35 mm)
- content:
 - 1 screw starters with countersink
 - 2 bits, Phillips PH 1 - 2
 - 2 bits, Pozidriv PZ 1 - 2
 - 2 bits, Torx TX 15 - 20
- suitable for 3082000

article no.	EAN	description	packaging
3085000	4006885... ...308503	1 flipbit set for woodworking 7 pieces	blister on card



- for equipping the flipbit dual tool holder
- shank: hexagon shank 1/4" (6,35 mm)
- content:
 - 1 receptacle for dual quick change holder, with triangular shank
 - 2 dual quick change holders
 - 3 metal drills, ø 2, 3, 4 mm, short
 - 2 bits, Phillips PH 1 - 2
 - 2 bits, Pozidriv PZ 1 - 2
 - 3 bits, Torx TX 15 - 20 - 25
 - 1 screw starters with countersink
 - 1 countersink, WS, ø 12 mm
 - 1 hook screwdriver bit
- in 2-component plastic box with lid

article no.	EAN	description
3086000	4006885... ...308602	1 all-in-one flipbit set 16-piece

6 POWER TOOL ACCESSORIES

6.3 Bits/ Handscrewdrivers/ Holders/ Adapters

Adapters



Compact 90° angular gear for drilling and screwing in tight places. Simple handy solution, ready for use at once.

- machine: cordless screwdrivers
- the corner dimension is only 52 mm including a 25 mm bit
- gear with ball-bearing
- right/left rotation
- max. 400 RPM
- max. 13 Nm
- packaging: double card with inlaid blister

article no.	EAN	description	shank	for	length
4688000	...468801	1 angular gear	6 mm (1/4")	suitable for bits and drills with hexagonal shank for wood with a diameter (Ø) of up to 10 mm, for metal with a Ø of up to 6 mm, for rock with a Ø of up to 10 mm	153 mm



- machine: power drills and screwdrivers
- packaging: blister on card

article no.	EAN	description	shank	for	length
1579000	...157903	1 adapter for sockets	6 mm (1/4")	for sockets with 6 mm (1/4") receptacle	50 mm
2415000	...241503	1 adapter for sockets	6 mm (1/4")	for sockets with 10 mm (3/8") receptacle	65 mm
2414000	...241404	1 adapter for sockets	6 mm (1/4")	for sockets with 13 mm (1/2") receptacle	72 mm

6.3 Bits/ Handscrewdrivers/ Holders/ Adapters



- machine: power drills and screwdrivers
- content:
 - 1 adapter for sockets, for sockets with 6 mm (1/4") receptacle, 50 mm
 - 1 adapter for sockets, for sockets with 10 mm (3/8") receptacle, 65 mm
 - 1 adapter for sockets, for sockets with 13 mm (1/2") receptacle, 72 mm
- packaging: blister on card

article no.	EAN	description	shank
8797000	4006885... ...879706	1 set of adapters for sockets, 3-piece	6 mm (1/4")

Wrench sockets



- machine: cordless screwdrivers and power drills
- for the toughest screw connections, also for professionals and semi-professionals
- high-quality inner magnet holds the screw or nut securely
- material: chromium-vanadium steel
- shank: hexagon shank 1/4" (6,35 mm)
- packaging: blister on card

article no.	EAN	description	wrench size	length
1379000	4006885... ...137905	1 wrench socket	SW 10	50 mm
1380000	...138001	1 wrench socket	SW 12	50 mm
1383000	...138308	1 wrench socket	SW 13	50 mm
1375000	...137509	1 wrench socket	SW 6	50 mm
1384000	...138407	1 wrench socket	SW 6,35 (1/4")	50 mm
1376000	...137608	1 wrench socket	SW 7	50 mm
1378000	...137806	1 wrench socket	SW 8	50 mm



- machine: cordless impact screwdrivers, cordless screwdrivers, power drills
- for the most exacting screw connections - also with impact screwdrivers
- high-quality inner magnet holds the screw or nut securely
- material: chrome molybdenum steel
- shank: hexagon shank 1/4" (6,35 mm)
- packaging: blister on card

article no.	EAN	description	wrench size	length
1392000	4006885... ...139206	1 Impact - wrench socket	SW 10	50 mm
1395000	...139503	1 Impact - wrench socket	SW 13	50 mm
1396000	...139602	1 Impact - wrench socket	SW 7,94 (5/16")	50 mm
1391000	...139107	1 Impact - wrench socket	SW 8	50 mm

6 POWER TOOL ACCESSORIES

6.3 Bits/ Handscrewdrivers/ Holders/ Adapters



- machine: cordless screwdrivers and power drills
- material: chromium-vanadium steel
- shank: Hexagonal shank 1/4" (6.35 mm), to DIN 3126-E6.3
- including: 1 adapter, 6 mm (1/4"), 50 mm
- packaging: blister on card

article no.	EAN	description	wrench size
2413000	4006885... ...241305	1 wrench socket set	SW 7, 8, 10, 13

Assortments



- for screwing in inaccessible places, by hand or with a power drill
- content:
 - 1 angular gear, for drilling and screwing at an angle of 90° angle in tight places
 - 1 miniature hand screwdriver, with ratchet, 116 mm
 - 6 bits, PH 2, PZ 2, TX 10, TX 15, TX 20, TX 25
- in 2-component plastic case

article no.	EAN	description
1001000	4006885... ...100107	1 drawer screwdriver set

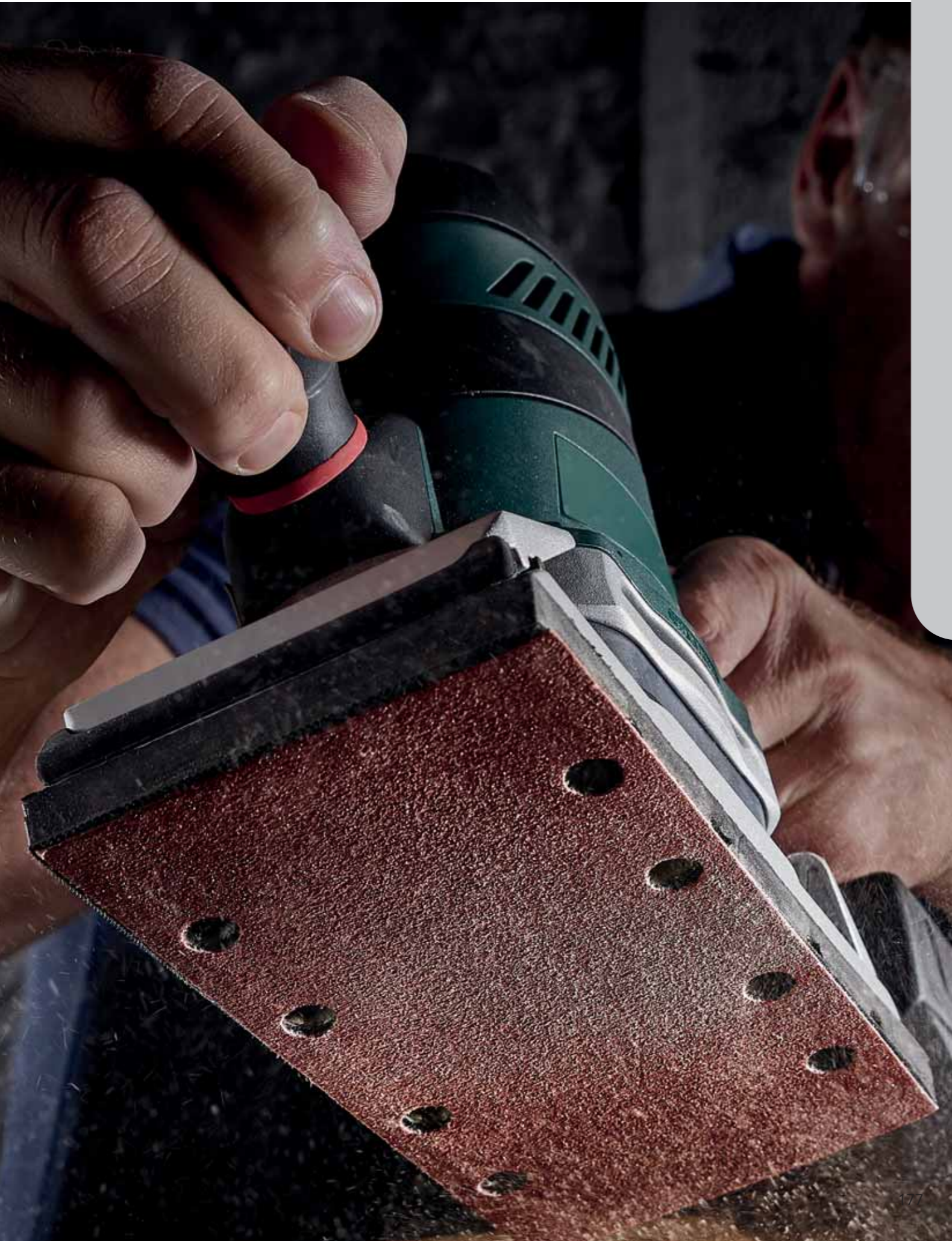

6.4 Abrasives

Eccentric sanders/wall and ceiling sanders

Easy fix sanding discs corundum ø 115 mm

suitable for Bosch, Einhell, Elu, Festool, Kress, Peugeot, RYOBI, Skil



- machine: eccentric sanders
- for wood, metals
- high durability
- resin-bonded
- fibre reinforced
- material: corundum



article no.	EAN 4006885...	description	Ø	grain	packaging
2269000	...226906	5 easy fix sanding discs	ø 115 mm	40	paperboard card
2269100	...226913	25 easy fix sanding discs	ø 115 mm	40	shrinkwrapped with inlay
2270000	...227002	5 easy fix sanding discs	ø 115 mm	60	paperboard card
2270100	...227019	25 easy fix sanding discs	ø 115 mm	60	shrinkwrapped with inlay
2271000	...227101	5 easy fix sanding discs	ø 115 mm	80	paperboard card
2271100	...227118	25 easy fix sanding discs	ø 115 mm	80	shrinkwrapped with inlay
2272000	...227200	5 easy fix sanding discs	ø 115 mm	120	paperboard card
2267100	...226715	25 easy fix sanding discs	ø 115 mm	80, 120, 240	shrinkwrapped with inlay

Easy fix backing pads ø 125 mm



- machine: eccentric sanders
- article no. 2258000: for the sanding on flat surfaces



article no.	EAN 4006885...	description	Ø	version	suitable for	packaging
2227000	...222700	1 easy fix backing pad	ø 125 mm	with holes	Bosch PEX 12, Bosch PEX 125, Bosch PEX 400	paperboard card
2258000	...225800	1 easy fix backing pad	ø 125 mm	hard version, with holes	Bosch, wolfcraft	paperboard card

POWER TOOL ACCESSORIES 6

6.4 Abrasives

Easy fix sanding discs corundum ø 125 mm

suitable for AEG, Atlas Copco, ayce, Black & Decker, Bosch, DeWalt, Einhell, Elu, Fein, Ferm, Festool, Flex, Güde, Hitachi, Kinzo, KRAFTRONIC, Kress, Mac Allister, Makita, Metabo, Milwaukee, RYOBI, Skil, Stanley, Worx



- machine: eccentric sanders
- for wood, metals
- resin-bonded
- fibre reinforced
- material: corundum



article no.	EAN	description	Ø	grain	packaging
8401000	4006885... ...840102	15 easy fix sanding discs	ø 125 mm	60, 80, 120	shrinkwrapped with inlay



- machine: eccentric sanders
- for wood, metals
- high durability
- resin-bonded
- fibre reinforced
- material: corundum



article no.	EAN	description	Ø	grain	packaging
3180000	4006885... ...318007	5 easy fix sanding discs	ø 125 mm	24	paperboard card
2069000	...206908	5 easy fix sanding discs	ø 125 mm	40	paperboard card
2069100	...206915	25 easy fix sanding discs	ø 125 mm	40	shrinkwrapped with inlay
2250000	...225008	5 easy fix sanding discs	ø 125 mm	60	paperboard card
2250100	...006232	25 easy fix sanding discs	ø 125 mm	60	shrinkwrapped with inlay
2070000	...207004	5 easy fix sanding discs	ø 125 mm	80	paperboard card
2070100	...006225	25 easy fix sanding discs	ø 125 mm	80	shrinkwrapped with inlay
2251000	...225107	5 easy fix sanding discs	ø 125 mm	120	paperboard card
2251100	...006966	25 easy fix sanding discs	ø 125 mm	120	shrinkwrapped with inlay
2252000	...225206	5 easy fix sanding discs	ø 125 mm	180	paperboard card
2253000	...225305	5 easy fix sanding discs	ø 125 mm	240	paperboard card
2072000	...207202	5 easy fix sanding discs	ø 125 mm	400	paperboard card
2259100	...225916	25 easy fix sanding discs	ø 125 mm	80, 120, 240	paperboard card

6.4 Abrasives

Easy fix sanding discs paint/varnish ø 125 mm

suitable for AEG, Atlas Copco, ayce, Black & Decker, Bosch, DeWalt, Einhell, Elu, Fein, Ferm, Festool, Flex, Güde, Hitachi, Kinzo, KRAFTRONIC, Kress, Mac Allister, Makita, Metabo, Milwaukee, RYOBI, Skil, Stanley, Worx



- machine: eccentric sanders
- for painted surfaces, metals, plastic materials
- reduces premature glazing of the graining when grinding paint, varnish and filler
- up to 4 times more durable than standard sanding paper
- special surface coating



article no.	EAN 4006885...	description	Ø	grain	packaging
1150000	...115002	5 easy fix sanding discs	ø 125 mm	40	paperboard card
1150100	...115019	25 easy fix sanding discs	ø 125 mm	40	shrinkwrapped with inlay
1151000	...115101	5 easy fix sanding discs	ø 125 mm	60	paperboard card
1152000	...115200	5 easy fix sanding discs	ø 125 mm	80	paperboard card
1152100	...115217	25 easy fix sanding discs	ø 125 mm	80	shrinkwrapped with inlay
1153000	...115309	5 easy fix sanding discs	ø 125 mm	120	paperboard card
1153100	...115316	25 easy fix sanding discs	ø 125 mm	120	shrinkwrapped with inlay
1157000	...115705	5 easy fix sanding discs	ø 125 mm	180	paperboard card
1156100	...115613	25 easy fix sanding discs	ø 125 mm	40, 80, 120	shrinkwrapped with inlay

Easy fix sanding discs wet/dry ø 125 mm

suitable for AEG, Atlas Copco, ayce, Black & Decker, Bosch, DeWalt, Einhell, Elu, Fein, Ferm, Festool, Flex, Güde, Hitachi, Kinzo, KRAFTRONIC, Kress, Mac Allister, Makita, Metabo, Milwaukee, RYOBI, Skil, Stanley, Worx



- machine: eccentric sanders
- for groove-free wet/dry grinding
- for metals, varnish, coating, plastic materials
- water-resistant
- highly flexible



article no.	EAN 4006885...	description	Ø	grain	packaging
3191000	...319103	5 easy fix sanding discs	ø 125 mm	280	paperboard card
3192000	...319202	5 easy fix sanding discs	ø 125 mm	400	paperboard card

POWER TOOL ACCESSORIES 6

6.4 Abrasives

Easy fix sanding pads ø 125 mm

suitable for AEG, Atlas Copco, Black & Decker, Bosch, DeWalt, Einhell, Elu, Fein, Ferm, Festo, Flex, Güde, Hitachi, Kinzo, KRAFTRONIC, Kress, Mac Allister, Makita, Metabo, Milwaukee, RYOBI, Skil, Stanley, wolf-craft, Worx

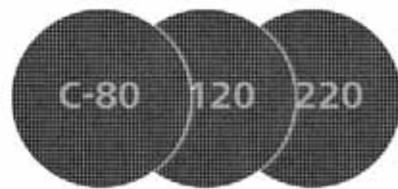

- machine: power drills and eccentric sanders
- for plasterboards, wood, paint
- high-quality grinding stone
- resin-bonded
- up to 4 times more durable than standard sanding paper
- perfect performance on very dusty surfaces
- the open-pore structure will allow the perfect extraction of dust on all sanders with dust extraction
- with easy-fix fibre for a fast change of the sanding paper
- material: silicium-carbide
- suitable for 2211000, 2223000, 5894000

article no.	EAN	description	Ø	grain	packaging
8464000	4006885... ...846401	5 easy fix sanding pads	ø 125 mm	80, 120, 220	paperboard card

Easy fix burnishing pads ø 125 mm



- machine: power drills and eccentric sanders
- for fine grinding
- for wood, OSB panels, metal, sheet steel, stainless steel
- innovative and highly effective burnishing pad
- suitable for 2211000, 2223000, 5894000

article no.	EAN	description	Ø	grain	packaging
3169000	4006885... ...316904	2 easy fix burnishing pads	ø 125 mm	280	paperboard card

6 POWER TOOL ACCESSORIES

6.4 Abrasives

Easy fix sanding discs corundum ø 150 mm

suitable for AEG, Atlas Copco, Bosch, DeWalt, Elu, Felisatti, Flex, Hilti, Kress, Metabo, Milwaukee, Peugeot, Wegoma



- machine: eccentric sanders
- for wood, metals
- high durability
- resin-bonded
- fibre reinforced
- material: corundum



article no.	EAN	description	Ø	grain	packaging
1838000	4006885... ...183803	12 easy fix sanding discs	ø 150 mm	60, 120, 240	shrinkwrapped with inlay

Easy fix sanding discs corundum ø 150 mm

suitable for Bosch, Fein, Festool, Flex, Hitachi, Holz-Her, MAFELL, Makita, Metabo, Peugeot, Wegoma



- machine: eccentric sanders
- for wood, metals
- resin-bonded
- fibre reinforced
- material: corundum



article no.	EAN	description	Ø	grain	packaging
8404000	4006885... ...840409	10 easy fix sanding discs	ø 150 mm	60, 80, 120	shrinkwrapped with inlay



- machine: eccentric sanders
- for wood, metals
- high durability
- resin-bonded
- fibre reinforced
- material: corundum



article no.	EAN	description	Ø	grain	packaging
1840000	4006885... ...184008	5 easy fix sanding discs	ø 150 mm	40	paperboard card
1841000	...184107	5 easy fix sanding discs	ø 150 mm	60	paperboard card
1842000	...184206	5 easy fix sanding discs	ø 150 mm	80	paperboard card
1843000	...184305	5 easy fix sanding discs	ø 150 mm	120	paperboard card

POWER TOOL ACCESSORIES

6.4 Abrasives

6

Easy fix sanding discs corundum ø 225 mm



- machine: wall and ceiling sanders
- for wood, paint/varnish
- with easy-fix fibre for a fast change of the sanding paper
- material: corundum



article no.	EAN	description	Ø	grain	packaging
5632000	4006885...563209	5 easy fix sanding discs	Ø 225 mm	60	paperboard card
5633000	...563308	5 easy fix sanding discs	Ø 225 mm	80	paperboard card
5634000	...563407	5 easy fix sanding discs	Ø 225 mm	120	paperboard card
5635000	...563506	5 easy fix sanding discs	Ø 225 mm	180	paperboard card

Easy fix sanding pads ø 225 mm



- machine: wall and ceiling sanders
- for plasterboards, wood, paint
- high-quality grinding stone
- resin-bonded
- up to 4 times more durable than standard sanding paper
- perfect performance on very dusty surfaces
- the open-pore structure will allow the perfect extraction of dust on all sanders with dust extraction
- with easy-fix fibre for a fast change of the sanding paper
- material: silicium-carbide
- suitable for 4052000

article no.	EAN	description	Ø	grain	packaging
5617000	4006885...561700	5 easy fix sanding pads	Ø 225 mm	80	paperboard card
2287000	...228702	5 easy fix sanding pads	Ø 225 mm	120	paperboard card
2288000	...228801	5 easy fix sanding pads	Ø 225 mm	220	paperboard card

6 POWER TOOL ACCESSORIES

6.4 Abrasives

Easy fix burnishing pads ø 225 mm



- machine: wall and ceiling sanders
- for fine grinding
- for wood, OSB panels, metal, sheet steel, stainless steel
- innovative and highly effective burnishing pad



article no.	EAN	description	Ø	grain	packaging
3168000	...316805	1 easy-fix burnishing pad	ø 225 mm	280	paperboard card

Belt sanders

Sanding belts 13 x 457 mm

suitable for Black & Decker BD 280, Black & Decker BD 282 E, Black & Decker BD 290, Black & Decker BD 292 E, Black & Decker KA 290, Black & Decker KA 292 E, Black & Decker KA 293 E, Black & Decker KA 900 E



- machine: belt sanders, Powerfile
- for wood, metal
- high durability
- flexible and strong
- material: corundum
- substrate: cotton fabric



article no.	EAN	description	grain	width	length	packaging
1724000	...172401	3 sanding belts	40	13 mm	457 mm	paperboard card
1725000	...172500	3 sanding belts	80	13 mm	457 mm	paperboard card
1726000	...172609	3 sanding belts	120	13 mm	457 mm	paperboard card
1869000	...186903	3 sanding belts	40, 80, 120	13 mm	457 mm	paperboard card

POWER TOOL ACCESSORIES 6

6.4 Abrasives

Sanding belts 40 x 303 mm

suitable for Bosch GVS 350 AE, Bosch PVS 280 A, Bosch PVS 300 AE, Bosch PVS 350 AE



- machine: belt sanders, Vario sander
- for wood, metal
- high durability
- flexible and strong
- material: corundum
- substrate: cotton fabric



article no.	EAN 4006885...	description	grain	width	length	packaging
1715000	...171503	3 sanding belts	60	40 mm	303 mm	paperboard card
1717000	...171701	3 sanding belts	80	40 mm	303 mm	paperboard card
1719000	...171909	3 sanding belts	120	40 mm	303 mm	paperboard card

Sanding belts 60 x 400 mm

suitable for Bosch PBS 60, Bosch PBS 60 E



- machine: belt sanders
- for wood, metal
- high durability
- flexible and strong
- material: corundum
- substrate: cotton fabric



article no.	EAN 4006885...	description	grain	width	length	packaging
1950000	...195004	3 sanding belts	40	60 mm	400 mm	paperboard card
1954000	...195400	3 sanding belts	80	60 mm	400 mm	paperboard card
1956000	...195608	3 sanding belts	120	60 mm	400 mm	paperboard card

Sanding belts 65 x 410 mm

suitable for AEG, Black & Decker, Holz-Her, Kress, Metabo



- machine: belt sanders
- for wood, metal
- high durability
- flexible and strong
- material: corundum
- substrate: cotton fabric



article no.	EAN 4006885...	description	grain	width	length	packaging
1900000	...190009	3 sanding belts	40	65 mm	410 mm	paperboard card
1902000	...190207	3 sanding belts	60	65 mm	410 mm	paperboard card
1904000	...190405	3 sanding belts	80	65 mm	410 mm	paperboard card

6.4 Abrasives



article no.	EAN 4006885...	description	grain	width	length	packaging
1906000	...190603	3 sanding belts	120	65 mm	410 mm	paperboard card
1899100	...189911	9 sanding belts	40, 80, 120	65 mm	410 mm	paperboard card

Sanding belts 75 x 510 mm

suitable for Black & Decker BD 85, Black & Decker DN 85, Black & Decker DN 85 E, Black & Decker P 61-03, Black & Decker SR 500 E



- machine: belt sanders
- for wood, metal
- high durability
- flexible and strong
- material: corundum
- substrate: cotton fabric



article no.	EAN 4006885...	description	grain	width	length	packaging
1908000	...190801	3 sanding belts	40	75 mm	510 mm	paperboard card
1912000	...191204	3 sanding belts	80	75 mm	510 mm	paperboard card
1914000	...191402	3 sanding belts	120	75 mm	510 mm	paperboard card

Sanding belts 75 x 533 mm

suitable for AEG, Atlas Copco, ayce, Black & Decker, Bosch, Casals, DeWalt, Einhell, Ferm, Festool, Hitachi, Holz-Her, Makita, Metabo, Milwaukee, PERLES, Peugeot, RYOBI, Skil, Stayer, triton



- machine: belt sanders
- for wood, metal
- flexible and strong
- material: corundum
- substrate: cotton fabric

article no.	EAN 4006885...	description	grain	width	length	packaging
8417000	...841703	5 sanding belts	40, 80, 120	75 mm	533 mm	shrinkwrapped with inlay

POWER TOOL ACCESSORIES

6.4 Abrasives

6



- machine: belt sanders
- for wood, metal
- high durability
- flexible and strong
- material: corundum
- substrate: cotton fabric



article no.	EAN	description	grain	width	length	packaging
1919000	...191907	3 sanding belts	24	75 mm	533 mm	paperboard card
1916000	...191600	3 sanding belts	40	75 mm	533 mm	paperboard card
3101000	...310100	6 sanding belts	40	75 mm	533 mm	shrinkwrapped with inlay
1918000	...191808	3 sanding belts	60	75 mm	533 mm	paperboard card
3102000	...310209	6 sanding belts	60	75 mm	533 mm	shrinkwrapped with inlay
1920000	...192003	3 sanding belts	80	75 mm	533 mm	paperboard card
3103000	...310308	6 sanding belts	80	75 mm	533 mm	shrinkwrapped with inlay
1922000	...192201	3 sanding belts	120	75 mm	533 mm	paperboard card
3104000	...310407	6 sanding belts	120	75 mm	533 mm	shrinkwrapped with inlay
1923000	...192300	3 sanding belts	180	75 mm	533 mm	paperboard card
1916100	...191617	9 sanding belts	40, 80, 120	75 mm	533 mm	paperboard card

Sanding belts 76 x 457 mm

suitable for Black & Decker, Bosch, Einhell, Güde, Kinzo, Mac Allister, Makita, Peugeot, RYOBI, Skil, Stayer, Worx



- machine: belt sanders
- for wood, metal
- flexible and strong
- material: corundum
- substrate: cotton fabric

article no.	EAN	description	grain	width	length	packaging
8415000	...841505	5 sanding belts	40, 80, 120	76 mm	457 mm	shrinkwrapped with inlay



- machine: belt sanders
- for wood, metal
- high durability
- flexible and strong
- material: corundum
- substrate: cotton fabric



article no.	EAN	description	grain	width	length	packaging
1890000	...189003	3 sanding belts	40	76 mm	457 mm	paperboard card
3111000	...311107	6 sanding belts	40	76 mm	457 mm	shrinkwrapped with inlay
1892000	...189201	3 sanding belts	60	76 mm	457 mm	paperboard card
3112000	...311206	6 sanding belts	60	76 mm	457 mm	shrinkwrapped with inlay

6.4 Abrasives



article no.	EAN 4006885...	description	grain	width	length	packaging
1894000	...189409	3 sanding belts	80	76 mm	457 mm	paperboard card
3113000	...311305	6 sanding belts	80	76 mm	457 mm	shrinkwrapped with inlay
1896000	...189607	3 sanding belts	120	76 mm	457 mm	paperboard card
3114000	...311404	6 sanding belts	120	76 mm	457 mm	shrinkwrapped with inlay
1897000	...189706	3 sanding belts	180	76 mm	457 mm	paperboard card
1890100	...189010	9 sanding belts	40, 80, 120	76 mm	457 mm	paperboard card

Sanding belts 100 x 560 mm

suitable for AEG, DeWalt, Elu, Festool, RYOBI



- machine: belt sanders
- for wood, metal
- high durability
- flexible and strong
- material: corundum
- substrate: cotton fabric



article no.	EAN 4006885...	description	grain	width	length	packaging
1932000	...193208	3 sanding belts	40	100 mm	560 mm	paperboard card
1934000	...193406	3 sanding belts	60	100 mm	560 mm	paperboard card
1936000	...193604	3 sanding belts	80	100 mm	560 mm	paperboard card
1938000	...193802	3 sanding belts	120	100 mm	560 mm	paperboard card
1933100	...193314	9 sanding belts	40, 80, 120	100 mm	560 mm	paperboard card

Sanding belts 100 x 610 mm

suitable for AEG, Bosch, Casals, Einhell, Ferm, Hitachi, KANGO, Makita, RYOBI, Skil, Stanley



- machine: belt sanders
- for wood, metal
- high durability
- flexible and strong
- material: corundum
- substrate: cotton fabric



article no.	EAN 4006885...	description	grain	width	length	packaging
1861000	...186101	3 sanding belts	40	100 mm	610 mm	paperboard card
3117000	...311701	3 sanding belts	60	100 mm	610 mm	paperboard card
1862000	...186200	3 sanding belts	80	100 mm	610 mm	paperboard card
1863000	...186309	3 sanding belts	120	100 mm	610 mm	paperboard card
1864000	...186408	3 sanding belts	180	100 mm	610 mm	paperboard card

POWER TOOL ACCESSORIES 6

6.4 Abrasives

Sanding belts 100 x 690 mm

suitable for Virutex AF11, Virutex LB31E, Virutex LB31EA



- machine: belt sanders
- for wood, metal
- high durability
- flexible and strong
- material: corundum
- substrate: cotton fabric



article no.	EAN 4006885...	description	grain	width	length	packaging
3122000	...312203	3 sanding belts	40	100 mm	690 mm	paperboard card
3124000	...312401	3 sanding belts	80	100 mm	690 mm	paperboard card
3125000	...312500	3 sanding belts	120	100 mm	690 mm	paperboard card

Sanding belts 105 x 620 mm

suitable for AEG, Atlas Copco, Bosch, Casals, Festool, Hitachi, Holz-Her, MAFELL, Metabo, Milwaukee



- machine: belt sanders
- for wood, metal
- high durability
- flexible and strong
- material: corundum



article no.	EAN 4006885...	description	grain	width	length	packaging
1940000	...194007	3 sanding belts	40	105 mm	620 mm	paperboard card
1944000	...194403	3 sanding belts	80	105 mm	620 mm	paperboard card
1946000	...194601	3 sanding belts	120	105 mm	620 mm	paperboard card
5627000	...562707	5 sanding belts	40, 60, 80, 120	105 mm	620 mm	shrinkwrapped with inlay

6.4 Abrasives

Orbital sanders

Easy fix sanding sheets, corundum 93 x 185 mm

suitable for AEG, Atlas Copco, ayce, Bosch, Einhell, Festool, Holz-Her, Makita, Metabo, Peugeot, RYOBI, Skil



- machine: orbital sanders
- for wood, metals
- high durability
- resin-bonded
- fibre reinforced
- material: corundum



article no.	EAN 4006885...	description	grain	version	width	length	packaging
1766000	...176607	10 easy fix sanding sheets	40	with holes	93 mm	185 mm	paperboard card
1749000	...174900	10 easy fix sanding sheets	60	with holes	93 mm	185 mm	paperboard card
1767000	...176706	10 easy fix sanding sheets	80	with holes	93 mm	185 mm	paperboard card
1768000	...176805	10 easy fix sanding sheets	120	with holes	93 mm	185 mm	paperboard card
5801000	...580107	10 easy fix sanding sheets	180	with holes	93 mm	185 mm	paperboard card
5803000	...580305	10 easy fix sanding sheets	240	with holes	93 mm	185 mm	paperboard card
1762000	...176201	10 easy fix sanding sheets	40, 80, 120	with holes	93 mm	185 mm	paperboard card

Easy fix sanding sheets paint/varnish 93 x 185 mm

suitable for AEG, Atlas Copco, ayce, Bosch, Einhell, Festool, Holz-Her, Makita, Metabo, Peugeot, RYOBI, Skil



- machine: orbital sanders
- for painted surfaces, metals, plastic materials
- reduces premature glazing of the graining when grinding paint, varnish and filler
- up to 4 times more durable than standard sanding paper
- special surface coating



article no.	EAN 4006885...	description	for	grain	version	width	length	packaging
1120000	...112001	10 easy fix sanding sheets	paint/varnish	40	with holes	93 mm	185 mm	paperboard card
1121000	...112100	10 easy fix sanding sheets	paint/varnish	60	with holes	93 mm	185 mm	paperboard card
1122000	...112209	10 easy fix sanding sheets	paint/varnish	80	with holes	93 mm	185 mm	paperboard card
1123000	...112308	10 easy fix sanding sheets	paint/varnish	120	with holes	93 mm	185 mm	paperboard card
1124000	...112407	10 easy fix sanding sheets	paint/varnish	180	with holes	93 mm	185 mm	paperboard card
5804000	...580404	10 easy fix sanding sheets	paint/varnish	240	with holes	93 mm	185 mm	paperboard card

POWER TOOL ACCESSORIES 6

6.4 Abrasives

Easy fix sanding sheets corundum 93 x 190 mm

suitable for Black & Decker KA 186, Black & Decker KA 186 E, Worx WX26FS



- machine: orbital sanders
- for wood, metals
- high durability
- resin-bonded
- fibre reinforced
- material: corundum



article no.	EAN 4006885...	description	grain	version	width	length	packaging
1992000	...199200	5 easy fix sanding sheets	40	with holes	93 mm	190 mm	paperboard card
1993000	...199309	5 easy fix sanding sheets	80	with holes	93 mm	190 mm	paperboard card
1994000	...199408	5 easy fix sanding sheets	120	with holes	93 mm	190 mm	paperboard card
1998000	...199804	10 easy fix sanding sheets	60, 120, 240	with holes	93 mm	190 mm	paperboard card

Sanding sheets corundum 93 x 230 mm

suitable for Bosch, Festool, Makita, Metabo, Peugeot, RYOBI, Skil, Stayer, Wagner



- machine: orbital sanders
- for wood, metals
- high durability
- material: corundum



article no.	EAN 4006885...	description	grain	version	width	length	packaging
1961000	...196100	5 sanding sheets	40	with holes	93 mm	230 mm	paperboard card
1962000	...196209	5 sanding sheets	80	with holes	93 mm	230 mm	paperboard card
1963000	...196308	5 sanding sheets	120	with holes	93 mm	230 mm	paperboard card
1966000	...196605	5 sanding sheets	180	with holes	93 mm	230 mm	paperboard card
5622000	...562202	5 sanding sheets	240	with holes	93 mm	230 mm	paperboard card
1959100	...195912	25 sanding sheets	40, 80, 120	with holes	93 mm	230 mm	paperboard card

6 POWER TOOL ACCESSORIES

6.4 Abrasives

Sanding sheets corundum 93 x 230 mm

suitable for AEG, Black & Decker, Bosch, Casals, Einhell, PERLES, Peugeot, Worx



- machine: orbital sanders
- for wood, metals
- material: corundum

article no.	EAN 4006885...	description	grain	version	width	length	packaging
8409000	...840904	15 sanding sheets	40, 80, 120	with holes	93 mm	230 mm	shrinkwrapped with inlay



- machine: orbital sanders
- for wood, metals
- high durability
- material: corundum



article no.	EAN 4006885...	description	grain	version	width	length	packaging
1971000	...197107	5 sanding sheets	40	with holes	93 mm	230 mm	paperboard card
1972000	...197206	5 sanding sheets	80	with holes	93 mm	230 mm	paperboard card
1973000	...197305	5 sanding sheets	120	with holes	93 mm	230 mm	paperboard card
1968000	...196803	5 sanding sheets	180	with holes	93 mm	230 mm	paperboard card
5623000	...562301	5 sanding sheets	240	with holes	93 mm	230 mm	paperboard card
1969100	...196919	25 sanding sheets	40, 80, 120	with holes	93 mm	230 mm	paperboard card

Easy fix sanding sheets corundum 100 x 115 mm

suitable for Hitachi PSU-8, Hitachi PSU-8, Hitachi PSU-8, Makita BO 4554, Makita BO 4554, Makita BO 4554, Makita BO 4554, Makita BO 4555, Metabo FSR 200 Intec



- machine: orbital sanders
- for wood, metals
- high durability
- resin-bonded
- fibre reinforced
- material: corundum



article no.	EAN 4006885...	description	grain	version	width	length	packaging
1761000	...176102	10 easy fix sanding sheets	60, 120, 240	with holes	100 mm	115 mm	paperboard card

POWER TOOL ACCESSORIES

6.4 Abrasives

6

Easy fix sanding sheets corundum 115 x 230 mm

suitable for AEG, Atlas Copco, Black & Decker, Bosch, Einhell, Elu, Fein, Festool, Hitachi, Holz-Her, KRAFTRONIC, Kress, LUX, MAFELL, Makita, Metabo, Peugeot, RYOBI, Skil



- machine: orbital sanders
- for wood, metals
- high durability
- resin-bonded
- fibre reinforced
- material: corundum



article no.	EAN 4006885...	description	grain	version	width	length	packaging
3182000	...318205	5 easy fix sanding sheets	40	with holes	115 mm	230 mm	paperboard card
3184000	...318403	5 easy fix sanding sheets	80	with holes	115 mm	230 mm	paperboard card
3185000	...318502	5 easy fix sanding sheets	120	with holes	115 mm	230 mm	paperboard card
1990000	...199002	5 easy fix sanding sheets	40, 80, 120	with holes	115 mm	230 mm	paperboard card

Sanding sheets corundum 115 x 280 mm

suitable for AEG, Atlas Copco, Black & Decker, Bosch, Einhell, Elu, Fein, Hitachi, KRAFTRONIC, Kress, MAFELL, Makita, Metabo, PERLES, Skil, Stayer, Wagner



- machine: orbital sanders
- for wood, metals
- high durability
- material: corundum



article no.	EAN 4006885...	description	grain	version	width	length	packaging
1981000	...198104	5 sanding sheets	40	with holes	115 mm	280 mm	paperboard card
1982000	...198203	5 sanding sheets	80	with holes	115 mm	280 mm	paperboard card
1983000	...198302	5 sanding sheets	120	with holes	115 mm	280 mm	paperboard card
1986200	...198623	25 sanding sheets	40, 80, 120	with holes	115 mm	280 mm	paperboard card

6.4 Abrasives

Sanding sheets corundum 93 x 230 mm



- machine: orbital sanders
- for wood, metals
- material: corundum

article no.	EAN 4006885...	description	grain	version	width	length	packaging
2049000	...204904	50 sanding sheets	40, 80, 120	without holes	93 mm	230 mm	paperboard card
8410000	...841000	30 sanding sheets	40, 80, 120	without holes	93 mm	230 mm	shrinkwrapped with inlay



- machine: orbital sanders
- for wood, metals
- high durability
- material: corundum



article no.	EAN 4006885...	description	grain	version	width	length	packaging
2082000	...208209	1 sanding sheet	40	without holes	93 mm	230 mm	bulk
2052000	...205208	8 sanding sheets	40	without holes	93 mm	230 mm	paperboard card
3150100	...315013	25 sanding sheets	60	without holes	93 mm	230 mm	shrinkwrapped with inlay
2083000	...208308	1 sanding sheet	80	without holes	93 mm	230 mm	bulk
2053000	...205307	8 sanding sheets	80	without holes	93 mm	230 mm	paperboard card
3151100	...315112	25 sanding sheets	80	without holes	93 mm	230 mm	shrinkwrapped with inlay
2084000	...208407	1 sanding sheet	120	without holes	93 mm	230 mm	bulk
2054000	...205406	8 sanding sheets	120	without holes	93 mm	230 mm	paperboard card
3152100	...315211	25 sanding sheets	120	without holes	93 mm	230 mm	shrinkwrapped with inlay
2080000	...208001	1 sanding sheet	180	without holes	93 mm	230 mm	bulk
2048000	...204805	8 sanding sheets	180	without holes	93 mm	230 mm	paperboard card
5625000	...562509	8 sanding sheets	240	without holes	93 mm	230 mm	paperboard card

Sanding sheets silicium-carbide 93 x 230 mm



- machine: orbital sanders
- for paint, varnish, coating, filler material
- high durability
- special grain distribution
- material: silicium-carbide



article no.	EAN 4006885...	description	grain	version	width	length	packaging
2092000	...209206	1 sanding sheet	24	without holes	93 mm	230 mm	bulk

POWER TOOL ACCESSORIES

6.4 Abrasives

6

Sanding sheets corundum 115 x 280 mm



- machine: orbital sanders
- for wood, metals
- material: corundum

article no.	EAN 4006885...	description	grain	version	width	length	packaging
2059000	...205901	50 sanding sheets	40, 80, 120	without holes	115 mm	280 mm	paperboard card
8411000	...841109	30 sanding sheets	40, 80, 120	without holes	115 mm	280 mm	shrinkwrapped with inlay



- machine: orbital sanders
- for wood, metals
- high durability
- material: corundum



article no.	EAN 4006885...	description	grain	version	width	length	packaging
2086000	...208605	1 sanding sheet	40	without holes	115 mm	280 mm	bulk
2056000	...205604	8 sanding sheets	40	without holes	115 mm	280 mm	paperboard card
3156100	...315617	25 sanding sheets	60	without holes	115 mm	280 mm	shrinkwrapped with inlay
2087000	...208704	1 sanding sheet	80	without holes	115 mm	280 mm	bulk
2057000	...205703	8 sanding sheets	80	without holes	115 mm	280 mm	paperboard card
3157100	...315716	25 sanding sheets	80	without holes	115 mm	280 mm	shrinkwrapped with inlay
2088000	...208803	1 sanding sheet	120	without holes	115 mm	280 mm	bulk
2058000	...205802	8 sanding sheets	120	without holes	115 mm	280 mm	paperboard card
3158100	...315815	25 sanding sheets	120	without holes	115 mm	280 mm	shrinkwrapped with inlay
2089000	...208902	1 sanding sheet	180	without holes	115 mm	280 mm	bulk
2061000	...206106	8 sanding sheets	180	without holes	115 mm	280 mm	paperboard card
5626000	...562608	8 sanding sheets	240	without holes	115 mm	280 mm	paperboard card

Sanding sheets silicium-carbide 115 x 280 mm



- machine: orbital sanders
- for paint, varnish, coating, filler material
- high durability
- special grain distribution
- material: silicium-carbide



article no.	EAN 4006885...	description	grain	version	width	length	packaging
2068000	...206809	1 sanding sheet	24	without holes	115 mm	280 mm	bulk

6 POWER TOOL ACCESSORIES

6.4 Abrasives

Easy fix sanding pads 93 x 190 mm

suitable for AEG, Atlas Copco, ayce, Black & Decker, Bosch, Einhell, Festool, Holz-Her, Makita, Metabo, Peugeot, RYOBI, Skil, Worx

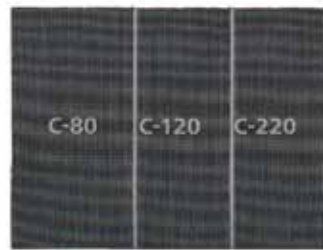

- machine: orbital sanders, hand-held sanders
- for gypsum plaster boards, wood, paint
- high-quality grinding stone
- resin-bonded
- up to 4 times more durable than standard sanding paper
- perfect performance on very dusty surfaces
- the open-pore structure will allow the perfect extraction of dust on all sanders with dust extraction
- with easy-fix fibre for a fast change of the sanding paper
- material: silicium-carbide



article no.	EAN	description	grain	width	length	packaging
8468000	4006885... ...846807	5 easy fix sanding pads	80, 120, 220	93 mm	190 mm	paperboard card

Grit cloths 93 x 230 mm



- machine: orbital sanders, hand-held sanders
- for gypsum plaster boards, wood, paint
- high-quality grinding stone
- resin-bonded
- up to 4 times more durable than standard sanding paper
- perfect performance on very dusty surfaces
- the open-pore structure will allow the perfect extraction of dust on all sanders with dust extraction
- material: silicium-carbide

article no.	EAN	description	grain	width	length	packaging
1997000	4006885... ...199705	2 grit cloths	120	93 mm	230 mm	paperboard card
1987000	...198708	2 grit cloths	220	93 mm	230 mm	paperboard card

POWER TOOL ACCESSORIES 6

6.4 Abrasives

Easy fix sanding pads 115 x 230 mm

suitable for AEG, Atlas Copco, Black & Decker, Bosch, Einhell, Elu, Fein, Festool, Hitachi, Holz-Her, KRAFTRONIC, Kress, LUX, MAFELL, Makita, Metabo, Peugeot, RYOBI, Skil

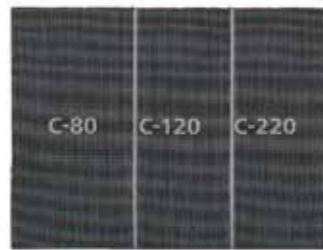

- machine: orbital sanders, hand-held sanders
- for gypsum plaster boards, wood, paint
- high-quality grinding stone
- resin-bonded
- up to 4 times more durable than standard sanding paper
- perfect performance on very dusty surfaces
- the open-pore structure will allow the perfect extraction of dust on all sanders with dust extraction
- with easy-fix fibre for a fast change of the sanding paper
- material: silicium-carbide



article no.	EAN	description	grain	width	length	packaging
8467000	4006885... ...846708	5 easy fix sanding pads	80, 120, 220	115 mm	230 mm	paperboard card

Grit cloths 115 x 280 mm



- machine: orbital sanders, hand-held sanders
- for gypsum plaster boards, wood, paint
- high-quality grinding stone
- resin-bonded
- up to 4 times more durable than standard sanding paper
- perfect performance on very dusty surfaces
- the open-pore structure will allow the perfect extraction of dust on all sanders with dust extraction
- material: silicium-carbide
- suitable for 4056000, 8722000

article no.	EAN	description	grain	width	length	packaging
1996000	4006885... ...199606	2 grit cloths	120	115 mm	280 mm	paperboard card
1988000	...198807	2 grit cloths	220	115 mm	280 mm	paperboard card
8406600	...840669	4 grit cloths	120, 220	115 mm	280 mm	paperboard card

6.4 Abrasives

Delta- / multi sanders

adhesive sanding plates corner measurement 95 mm

- machine: delta- / multi sander



article no.	EAN	description	version	suitable for	corner measurement	packaging
1830000	4006885... ...183001	1 adhesive sanding plate	hard version, with holes	Bosch GDA 280 E, Bosch PDA 180/E, Bosch PDA 240 E	95 mm	paperboard card

Easy fix sanding discs corundum corner measurement 95 mm

suitable for Black & Decker, Bosch, Casals, Einhell, Festool, HAAGER, KRAFTRONIC, Makita, Metabo, Skil

- machine: delta- / multi sander
- for wood, metals
- resin-bonded
- fibre reinforced
- material: corundum



article no.	EAN	description	grain	corner measurement	packaging
8403000	4006885... ...840300	15 easy fix sanding discs	60, 80, 120	95 mm	shrinkwrapped with inlay

- machine: delta- / multi sander
- for wood, metals
- high durability
- resin-bonded
- fibre reinforced
- material: corundum



article no.	EAN	description	grain	corner measurement	packaging
1850000	4006885... ...185005	5 easy fix sanding discs	40	95 mm	paperboard card
1850100	...185012	25 easy fix sanding discs	40	95 mm	shrinkwrapped with inlay
1851000	...185104	5 easy fix sanding discs	60	95 mm	paperboard card
1851100	...185111	25 easy fix sanding discs	60	95 mm	shrinkwrapped with inlay
1852000	...185203	5 easy fix sanding discs	80	95 mm	paperboard card
1852100	...185210	25 easy fix sanding discs	80	95 mm	shrinkwrapped with inlay



POWER TOOL ACCESSORIES

6.4 Abrasives

6



article no.	EAN 4006885...	description	grain	corner measurement	packaging
1853000	...185302	5 easy fix sanding discs	120	95 mm	paperboard card
1853100	...185319	25 easy fix sanding discs	120	95 mm	shrinkwrapped with inlay
1826000	...182608	5 easy fix sanding discs	180	95 mm	paperboard card
1854000	...185401	5 easy fix sanding discs	240	95 mm	paperboard card
1866000	...186606	20 easy fix sanding discs	40, 60, 80, 120, 180	95 mm	shrinkwrapped with inlay
1857000	...185708	20 easy fix sanding discs	60, 120, 240	95 mm	paperboard card
1865100	...186514	25 easy fix sanding discs	60, 80, 120	95 mm	paperboard card

Easy fix sanding discs paint/varnish corner measurement 95 mm

suitable for Black & Decker, Bosch, Casals, Einhell, Festool, HAAGER, KRAFTRONIC, Makita, Metabo, Skil



- machine: delta- / multi sander
- for painted surfaces, metals, plastic materials
- reduces premature glazing of the graining when grinding paint, varnish and filler
- up to 4 times more durable than standard sanding paper
- special surface coating



article no.	EAN 4006885...	description	grain	corner measurement	packaging
1160000	...116009	5 easy fix sanding discs	40	95 mm	paperboard card
1161000	...116108	5 easy fix sanding discs	60	95 mm	paperboard card
1162000	...116207	5 easy fix sanding discs	80	95 mm	paperboard card
1163000	...116306	5 easy fix sanding discs	120	95 mm	paperboard card
1167000	...116702	5 easy fix sanding discs	180	95 mm	paperboard card

6.4 Abrasives

Easy fix sanding pads corner measurement 95 mm

suitable for AEG, ayce, Black & Decker, Bosch, Casals, CRAFTSMAN, DeWalt, DEXTER, DREMEL, Einhell, Fein, Festool, HAAGER, KRAFTRONIC, Mac Allister, Makita, Mastercraft, Metabo, Milwaukee, Passat, PorterCable, Rockwell, RYOBI, Skil, Stanley, wolcraft, Worx



- machine: delta sanders and corner sanders 5884000
- for plasterboards, wood, paint
- high-quality grinding stone
- resin-bonded
- up to 4 times more durable than standard sanding paper
- perfect performance on very dusty surfaces
- the open-pore structure will allow the perfect extraction of dust on all sanders with dust extraction
- with easy-fix fibre for a fast change of the sanding paper
- material: silicium-carbide
- suitable for 5884000



article no.	EAN	description	grain	corner measurement	packaging
8469000	4006885... ...846906	5 easy fix sanding pads	80, 120, 220	95 mm	paperboard card

Easy fix sanding discs corundum corner measurement 105 mm

suitable for AEG, Kress



- machine: delta- / multi sander
- for wood, metals
- high durability
- resin-bonded
- fibre reinforced
- material: corundum



article no.	EAN	description	grain	corner measurement	packaging
1780000	4006885... ...178007	5 easy fix sanding discs	40	105 mm	paperboard card
1781000	...178106	5 easy fix sanding discs	60	105 mm	paperboard card
1782000	...178205	5 easy fix sanding discs	80	105 mm	paperboard card
1783000	...178304	5 easy fix sanding discs	120	105 mm	paperboard card
1787000	...178700	20 easy fix sanding discs	60, 120, 240	105 mm	paperboard card

POWER TOOL ACCESSORIES 6

6.4 Abrasives

2 pcs: delta sanding disc 95 mm + base sanding sheet corundum

suitable for Bosch, Bosch, Bosch, Bosch, Bosch, Bosch Prio, Bosch PSM 160 A, Bosch Ventaro, Einhell HES 160, Güde GTKS 315 315 30 3, KRAFTRONIC, KRAFTRONIC, Metabo FMS 200 Intec, Skil Octo

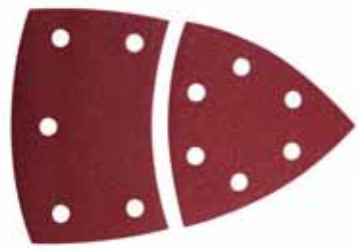

- machine: delta- / multi sander
- for wood, metals
- high durability
- resin-bonded
- fibre reinforced
- material: corundum



article no.	EAN 4006885...	description	grain	corner measurement	packaging
1811000	...181106	10 easy fix sanding discs	40	95 mm	paperboard card
1812000	...181205	10 easy fix sanding discs	60	95 mm	paperboard card
1813000	...181304	10 easy fix sanding discs	80	95 mm	paperboard card
1814000	...181403	10 easy fix sanding discs	120	95 mm	paperboard card
5619000	...561908	10 easy fix sanding discs	180	95 mm	paperboard card
5620000	...562004	10 easy fix sanding discs	240	95 mm	paperboard card
3118000	...311800	15 easy fix sanding discs	40, 80, 120	95 mm	paperboard card

2 pcs: delta sanding disc 95 mm + base sanding sheet paint/ varnish

suitable for Bosch, Bosch, Bosch, Bosch, Bosch, Bosch Prio, Bosch PSM 160 A, Bosch Ventaro, Einhell HES 160, Güde GTKS 315 315 30 3, KRAFTRONIC, KRAFTRONIC, Metabo FMS 200 Intec, Skil Octo

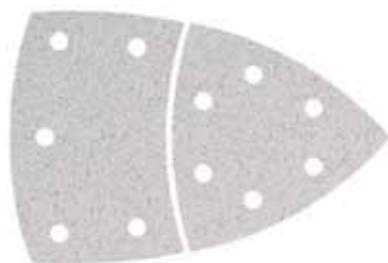

- machine: delta- / multi sander
- for painted surfaces, metals, plastic materials
- reduces premature glazing of the graining when grinding paint, varnish and filler
- up to 4 times more durable than standard sanding paper
- special surface coating



article no.	EAN 4006885...	description	grain	corner measurement	packaging
1125000	...112506	10 easy fix sanding discs	40	95 mm	paperboard card
1127000	...112704	10 easy fix sanding discs	80	95 mm	paperboard card
1128000	...112803	10 easy fix sanding discs	120	95 mm	paperboard card
1129000	...112902	10 easy fix sanding discs	180	95 mm	paperboard card
1189000	...118904	15 easy fix sanding discs	40, 80, 120	95 mm	paperboard card

6 POWER TOOL ACCESSORIES

6.4 Abrasives

Easy fix sanding discs corundum 96 x 136 mm

suitable for Black & Decker KA 1000, Black & Decker KA 150 K, Black & Decker KA 165 GT, Black & Decker KA 165 GTK, Black & Decker KA 250 KQS, Black & Decker Sandstorm KA 250 K, Bosch

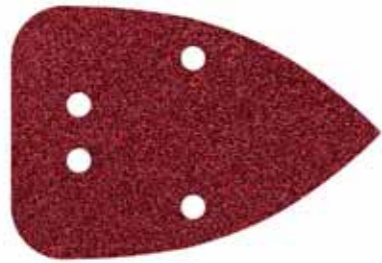

- machine: delta- / multi sander
- for wood, metals
- high durability
- resin-bonded
- fibre reinforced
- material: corundum



article no.	EAN 4006885...	description	grain	width	length	packaging
1757000	...175709	10 easy fix sanding discs	80	96 mm	136 mm	paperboard card
1763000	...176300	10 easy fix sanding discs	120	96 mm	136 mm	paperboard card
1764000	...176409	10 easy fix sanding discs	240	96 mm	136 mm	paperboard card
1756000	...175600	10 easy fix sanding discs	80, 120, 240	96 mm	136 mm	paperboard card

Easy fix sanding discs corundum 98 x 139 mm

suitable for ayce, RYOBI CCC-1801M, RYOBI ECS-1214N

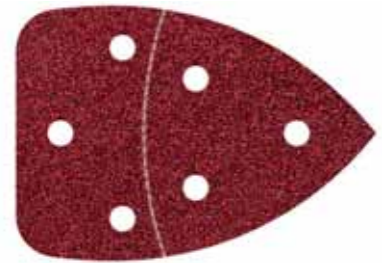

- machine: delta- / multi sander
- for wood, metals
- high durability
- resin-bonded
- fibre reinforced
- material: corundum



article no.	EAN 4006885...	description	grain	width	length	packaging
3136000	...313606	6 easy fix sanding discs	40	98 mm	139 mm	paperboard card
3137000	...313705	6 easy fix sanding discs	80	98 mm	139 mm	paperboard card
3138000	...313804	6 easy fix sanding discs	120	98 mm	139 mm	paperboard card
3139000	...313903	6 easy fix sanding discs	180	98 mm	139 mm	paperboard card

POWER TOOL ACCESSORIES

6.4 Abrasives

6

Easy fix sanding discs corundum 107 x 142 mm

suitable for Black & Decker KA 270 LDK, Black & Decker KA210, Black & Decker KA210E, Black & Decker KA220, Black & Decker KA220E, Black & Decker KA220G, Black & Decker KA260GTK, Black & Decker KA270GT, Black & Decker KA270GTK, Black & Decker Sandstorm KA 250 K, RYOBI EMS 180 RV

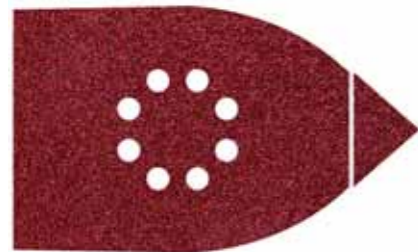

- machine: delta- / multi sander
- for wood, metals
- high durability
- resin-bonded
- fibre reinforced
- material: corundum
- including: 18 tips



article no.	EAN	description	grain	width	length	packaging
1790000	...179004	6 easy fix sanding discs	40	107 mm	142 mm	paperboard card
1791000	...179103	6 easy fix sanding discs	60	107 mm	142 mm	paperboard card
1792000	...179202	6 easy fix sanding discs	80	107 mm	142 mm	paperboard card
1793000	...179301	6 easy fix sanding discs	120	107 mm	142 mm	paperboard card
1794000	...179400	6 easy fix sanding discs	180	107 mm	142 mm	paperboard card
5621000	...562103	6 easy fix sanding discs	240	107 mm	142 mm	paperboard card
1760000	...176003	6 easy fix sanding discs	80, 120, 240	107 mm	142 mm	paperboard card

Easy fix sanding discs corundum 107 x 175 mm

suitable for Black & Decker KA 270 LDK, Black & Decker KA210, Black & Decker KA210E, Black & Decker KA220, Black & Decker KA220E, Black & Decker KA220G, Black & Decker KA260GTK, Black & Decker KA270GT, Black & Decker KA270GT, Black & Decker KA270GT, Black & Decker KA270GT, Black & Decker KA270GT, Black & Decker Sandstorm KA 250 K, Einhell HES 160

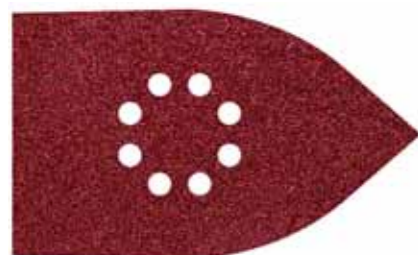

- machine: delta- / multi sander
- for wood, metals
- high durability
- resin-bonded
- fibre reinforced
- material: corundum



article no.	EAN	description	grain	width	length	packaging
1755000	...175501	10 easy fix sanding discs	80, 120, 240	107 mm	175 mm	shrinkwrapped with inlay

6.4 Abrasives

Easy fix sanding pads 107 x 175 mm

suitable for Black & Decker, Einhell



- machine: delta- / multi sander
- for plasterboards, wood, paint
- high-quality grinding stone
- resin-bonded
- up to 4 times more durable than standard sanding paper
- perfect performance on very dusty surfaces
- the open-pore structure will allow the perfect extraction of dust on all sanders with dust extraction
- with easy-fix fibre for a fast change of the sanding paper
- material: silicium-carbide



article no.	EAN	description	grain	width	length	packaging
8465000	4006885... ...846500	5 easy fix sanding pads	80, 120, 220	107 mm	175 mm	paperboard card

Easy fix sanding pads 290 x 250 mm

suitable for Feider FPEP1200CPC, Flex WSE 7 Vario Plus, Flex WST 700 VV Plus, Menzer TSW 225, Menzer TSW 225 AV, Menzer TSW 225 PRO, PowerPlus POWX0477



- machine: wall and ceiling sanders
- for plasterboards, wood, paint
- high-quality grinding stone
- resin-bonded
- up to 4 times more durable than standard sanding paper
- perfect performance on very dusty surfaces
- the open-pore structure will allow the perfect extraction of dust on all sanders with dust extraction
- with easy-fix fibre for a fast change of the sanding paper
- material: silicium-carbide



article no.	EAN	description	grain	product dimensions	packaging
3162000	4006885... ...316201	3 easy fix sanding pads	120	290 x 250 mm	paperboard card

POWER TOOL ACCESSORIES 6

6.4 Abrasives

Angle grinders

Easy fix backing pads



- machine: angle grinders
- packaging: paperboard card



article no.	EAN 4006885...	description	Ø	thread	separate accessories
2281000	...228108	1 easy fix backing pad	Ø 115 mm	M 14	2282100, 2283100, 2284100
2285000	...228504	1 easy fix backing pad	Ø 125 mm	M 14	2213100, 2214100, 2215100, 2216000, 2217100, 2218100, 2219000, 2225000, 2241100, 2242100, 2243100, 2260000
5618000	...561809	1 easy fix backing pad	Ø 180 mm	M 14	5614000, 5615000, 5616000

Backing pads



- machine: angle grinders
- version: with thread M14
- packaging: paperboard card

article no.	EAN 4006885...	description	Ø	thread	separate accessories
2450000	...245006	1 backing pad	Ø 115 mm	M 14	2460000, 2461000, 2462000, 2465000, 2476000
2454000	...245402	1 backing pad	Ø 125 mm	M 14	2455000, 2466000, 2467000, 2468000, 2469000
2452000	...245204	1 backing pad	Ø 178 mm	M 14	2470000, 2471000, 2472000, 2475000

6.4 Abrasives

Lamellar flap discs zircon corundum



- machine: angle grinders
- for the coarse sanding of metal surfaces
- disc made of fibre-glass reinforced polyester
- several times the service life of fibre sanding discs or grinding discs
- according to EN 13743
- material: zircon corundum

article no.	EAN 4006885...	description	Ø	grain	bore	packaging
2029000	...202900	1 lamellar flap disc	Ø 115 mm	40	Ø 22.2 mm	paperboard card
2029099	...004726	1 lamellar flap disc	Ø 115 mm	40	Ø 22.2 mm	bulk
2028000	...202801	1 lamellar flap disc	Ø 115 mm	60	Ø 22.2 mm	paperboard card
2028099	...004719	1 lamellar flap disc	Ø 115 mm	60	Ø 22.2 mm	bulk
2027000	...202702	1 lamellar flap disc	Ø 115 mm	80	Ø 22.2 mm	paperboard card
2027099	...004702	1 lamellar flap disc	Ø 115 mm	80	Ø 22.2 mm	bulk
2015000	...201507	1 lamellar flap disc	Ø 125 mm	40	Ø 22.2 mm	paperboard card
2016000	...201606	1 lamellar flap disc	Ø 125 mm	60	Ø 22.2 mm	paperboard card
2017000	...201705	1 lamellar flap disc	Ø 125 mm	80	Ø 22.2 mm	paperboard card



- machine: angle grinders
- for the coarse sanding of metal surfaces
- disc made of fibre-glass reinforced polyester
- high durability
- according to EN 13743
- material: zircon corundum
- packaging: bulk



article no.	EAN 4006885...	description	Ø	grain	bore
5650000	...565005	1 lamellar flap disc	Ø 115 mm	40	Ø 22.2 mm
5651000	...565104	1 lamellar flap disc	Ø 115 mm	60	Ø 22.2 mm
5652000	...565203	1 lamellar flap disc	Ø 115 mm	80	Ø 22.2 mm
5653000	...565302	1 lamellar flap disc	Ø 125 mm	40	Ø 22.2 mm
5654000	...565401	1 lamellar flap disc	Ø 125 mm	60	Ø 22.2 mm
5655000	...565500	1 lamellar flap disc	Ø 125 mm	80	Ø 22.2 mm

POWER TOOL ACCESSORIES 6

6.4 Abrasives

Lamellar flap discs corundum



- machine: angle grinders
- for the coarse sanding of metal surfaces
- disc made of fibre-glass reinforced polyester
- according to EN 13743
- material: corundum
- packaging: bulk

article no.	EAN	description	∅	grain	bore
8426000	...842601	1 lamellar flap disc	∅ 115 mm	40	∅ 22.2 mm
8425000	...842502	1 lamellar flap disc	∅ 125 mm	40	∅ 22.2 mm

Felt / fibre lamellar flap discs



- machine: angle grinders
- for polishing
- for processing polishes and polishing pastes (e.g. Art. No. 2134000)
- for stainless steel, steel, aluminium, non-ferrous metals
- according to EN 13743
- material: felt
- packaging: bulk

article no.	EAN	description	∅	bore
8424099	...010291	1 felt lamellar flap disc	∅ 115 mm	∅ 22.2 mm



- machine: angle grinders
- with coarse burnishing pad for grinding and de-rusting
- fast and gentle cleaning
- for stainless steel, steel, aluminium, non-ferrous metals
- according to EN 13743
- material: an innovative and highly effective burnishing pad with fan-shaped lamellar structure
- packaging: bulk



article no.	EAN	description	∅	bore
8422099	...010277	1 fibre lamellar flap disc	∅ 115 mm	∅ 22.2 mm

6 POWER TOOL ACCESSORIES

6.4 Abrasives



- machine: angle grinders
- with fine burnishing pad for fine grinding and polishing
- fast and gentle cleaning
- for stainless steel, steel, aluminium, non-ferrous metals
- according to EN 13743
- material: an innovative and highly effective burnishing pad with fan-shaped lamellar structure
- packaging: bulk



article no.	EAN	description	Ø	bore
8423099	...010284	1 fibre lamellar flap disc	Ø 115 mm	Ø 22.2 mm
8421099	...842106	1 fibre lamellar flap disc	Ø 125 mm	Ø 22.2 mm

Easy fix sanding discs corundum Ø 115 mm



- for backing pads Ø 115 mm with easy-fix fibre
- for wood, metal
- high durability
- resin-bonded
- fibre reinforced
- material: corundum
- packaging: paperboard card
- suitable for 2281000



article no.	EAN	description	Ø	grain	version
2282100	...000360	5 easy fix sanding discs	Ø 115 mm	40	without holes
2283100	...000377	5 easy fix sanding discs	Ø 115 mm	80	without holes
2284100	...000384	5 easy fix sanding discs	Ø 115 mm	180	without holes

POWER TOOL ACCESSORIES 6

6.4 Abrasives

Fibre discs



- for backing pads
- for metal working
- resin-bonded
- according to EN 13743
- packaging: shrinkwrapped with inlay

article no.	EAN 4006885...	description	∅	grain	suitable for
2460000	...246003	5 fibre discs	∅ 115 mm	24	2450000
2461000	...246102	5 fibre discs	∅ 115 mm	40	2450000
2462000	...246201	5 fibre discs	∅ 115 mm	60	2450000
2465000	...246508	5 fibre discs	∅ 115 mm	100	2450000
2466000	...246607	5 fibre discs	∅ 125 mm	24	2454000
2467000	...246706	5 fibre discs	∅ 125 mm	40	2454000
2468000	...246805	5 fibre discs	∅ 125 mm	60	2454000
2469000	...246904	5 fibre discs	∅ 125 mm	100	2454000
2470000	...247000	5 fibre discs	∅ 180 mm	24	2452000
2471000	...247109	5 fibre discs	∅ 180 mm	40	2452000
2472000	...247208	5 fibre discs	∅ 180 mm	60	2452000
2475000	...247505	5 fibre discs	∅ 180 mm	100	2452000
2476000	...247604	20 fibre discs	∅ 115 mm	24, 40, 60, 100	2450000
2455000	...245501	20 fibre discs	∅ 125 mm	24, 40, 60, 100	2454000

Easy fix sanding pads ∅ 180 mm



- machine: renovation grinder, angle grinder
- for easy fix backing pad ∅ 180 mm
- for plasterboards, wood
- up to 4 times more durable than standard sanding paper
- perfect performance on very dusty surfaces
- the open-pore structure will allow the perfect extraction of dust on all sanders with dust extraction
- with easy-fix fibre for a fast change of the sanding paper
- material: silicium-carbide
- packaging: paperboard card
- suitable for 5618000



article no.	EAN 4006885...	description	∅	grain
5614000	...561403	5 easy fix sanding pads	∅ 180 mm	80
5615000	...561502	5 easy fix sanding pads	∅ 180 mm	120
5616000	...561601	5 easy fix sanding pads	∅ 180 mm	220

6 POWER TOOL ACCESSORIES

6.4 Abrasives

Assortments



- machine: angle grinders
- packaging: blister on card

article no.	EAN	description	content	Ø	grain
2177000	4006885... ...217706	1 hobby set	1 backing pad	Ø 115 mm	
			5 fibre discs	Ø 115 mm	24, 24, 60, 80, 100
			1 lambswool bonnet	Ø 140 mm	
			1 wire cup brush	Ø 70 mm	

Miscellaneous



- machine: angle grinders
- for all large-surface de-rusting jobs
- for preparation of welding work
- for stone, metals, stainless steel, wood, varnish
- fast, aggressive surface working
- made of high-quality carrier with silicon carbide grain
- high material removal
- packaging: bulk



article no.	EAN	description	Ø	bore
1673000	4006885... ...167308	1 universal cleaning disc	Ø 115 mm	Ø 22.2 mm
1672000	...167209	1 universal cleaning disc	Ø 125 mm	Ø 22.2 mm

POWER TOOL ACCESSORIES 6

6.4 Abrasives

Power drills

Sanding pad fixoflex



- machine: power drills
- optimal adaptation of the sanding face to the workpiece
- allows scratch-free sanding without vibrations
- version: with easy-fix fastening
- packaging: double blister on card
- separate accessories: 2208000, 2213100, 2214100, 2215100, 2216000, 2217100, 2218100, 2219000, 2224000, 2225000, 2241100, 2242100, 2243100, 2249000, 2260000, 3169000, 8464000



article no.	EAN	description	∅	shank
2211000	4006885... ...221109	1 fixoflex - sanding pad	∅ 125 mm	∅ 8 mm

Easy fix backing pads ∅ 125 mm



- machine: power drills
- version: area with easy-fix system
- packaging: paperboard card
- separate accessories: 2208000, 2213100, 2214100, 2215100, 2216000, 2217100, 2218100, 2219000, 2224000, 2225000, 2241100, 2242100, 2243100, 2249000, 2260000, 3169000, 8464000

article no.	EAN	description	∅	shank	shank
2223000	4006885... ...222304	1 easy fix backing pad	∅ 125 mm	round shank	∅ 8 mm

6.4 Abrasives

Easy fix sanding discs corundum ø 125 mm



- for backing pads ø 125 mm with easy-fix fibre
- for wood, paint, metal
- high durability
- resin-bonded
- fibre reinforced
- material: corundum
- packaging: paperboard card
- suitable for 2211000, 2223000, 2285000



article no.	EAN 4006885...	description	Ø	grain	version
2241100	...224117	5 easy fix sanding discs	ø 125 mm	40	without holes
2213100	...000339	5 easy fix sanding discs	ø 125 mm	60	without holes
2214100	...000346	5 easy fix sanding discs	ø 125 mm	80	without holes
2242100	...224216	5 easy fix sanding discs	ø 125 mm	120	without holes
2243100	...224315	5 easy fix sanding discs	ø 125 mm	180	without holes
2215100	...000353	5 easy fix sanding discs	ø 125 mm	240	without holes
2260000	...226005	12 easy fix sanding discs	ø 125 mm	40, 80, 240	without holes
2216000	...221604	5 easy fix sanding discs	ø 125 mm	60, 80, 240	without holes

Easy fix sanding discs wet/dry ø 125 mm



- for backing pads ø 125 mm with easy-fix fibre
- for groove-free wet/dry grinding
- for metals, varnish, coating, plastic materials
- water-resistant
- highly flexible
- packaging: paperboard card
- suitable for 2211000, 2223000, 2285000



article no.	EAN 4006885...	description	Ø	for	grain	version
2217100	...221710	5 easy fix sanding discs	ø 125 mm	wet/dry	280	without holes
2218100	...221819	5 easy fix sanding discs	ø 125 mm	wet/dry	400	without holes

POWER TOOL ACCESSORIES 6

6.4 Abrasives

Easy fix sanding discs silicium-carbide ø 125 mm



- for backing pads ø 125 mm with easy-fix fibre
- for wood, paint, stone
- high durability
- high material removal
- resin-bonded
- fibre reinforced
- material: silicium-carbide
- packaging: paperboard card
- suitable for 2211000, 2223000, 2285000



article no.	EAN	description	ø	grain	version
2225000	4006885... ...222502	5 easy fix sanding discs	ø 125 mm	24	without holes

Easy fix burnishing pads ø 125 mm



- for backing pads ø 125 mm with easy-fix fibre
- for dry and wet grinding
- for fine grinding sheet metal (car body parts)
- packaging: paperboard card
- suitable for 2211000, 2223000, 2285000



article no.	EAN	description	ø	version
2219000	4006885... ...221901	1 easy-fix burnishing pad	ø 125 mm	without holes

6 POWER TOOL ACCESSORIES

6.4 Abrasives

Easy fix sanding discs corundum ø 178 mm



- for bench sander ø 178 mm with easy-fix fibre
- for wood, metals
- extraordinary sanding power
- extremely long durability
- fibre reinforced
- material: corundum
- packaging: paperboard card



article no.	EAN	description	Ø	grain	version
4756000	...475601	2 easy fix sanding discs	ø 178 mm	40, 80	without holes

Backing pads ø 125 mm



- machine: power drills
- packaging: paperboard card
- separate accessories: 2000000, 2001000, 2002000, 2003000, 2025000

article no.	EAN	description	Ø	shank
2020000	...202009	1 backing pad	ø 125 mm	ø 8 mm

Sanding discs corundum ø 125 mm



- for backing pad ø 125 mm
- for wood
- material: corundum
- packaging: paperboard card
- suitable for 2020000

article no.	EAN	description	Ø	grain
2001000	...200104	10 sanding discs	ø 125 mm	40
2002000	...200203	10 sanding discs	ø 125 mm	80
2003000	...200302	10 sanding discs	ø 125 mm	120
2000000	...200005	10 sanding discs	ø 125 mm	40, 80, 120

POWER TOOL ACCESSORIES 6

6.4 Abrasives

Rotary flap wheel sanders



- machine: power drills
- for wood, plastic materials, metals, etc.
- packaging: paperboard card

article no.	EAN 4006885...	description	Ø	shank	grain	height of grinding tool
2037000	...203709	1 rotary flap wheel sander	Ø 20 mm	Ø 6 mm	120	20 mm
2036000	...203600	1 rotary flap wheel sander	Ø 50 mm	Ø 6 mm	80	20 mm
2035000	...203501	1 rotary flap wheel sander	Ø 60 mm	Ø 6 mm	150	40 mm
2033000	...203303	1 rotary flap wheel sander	Ø 80 mm	Ø 6 mm	60	30 mm
2034000	...203402	1 rotary flap wheel sander	Ø 80 mm	Ø 6 mm	80	40 mm



- machine: power drills
- for wood, plastic materials, metals, etc.
- packaging: paperboard card

article no.	EAN 4006885...	description	Ø	shank	grain	height of grinding tool
2032000	...203204	1 flap wheel burnishing mop	Ø 50 mm	Ø 6 mm	150	25 mm

Miscellaneous



- machine: power drills
- for all large-surface de-rusting jobs
- for stone, metals, stainless steel, wood, varnish
- fast, aggressive surface working
- high removing capacity without damaging the material
- packaging: paperboard card

article no.	EAN 4006885...	description	Ø	shank	height of grinding tool
1674000	...167407	1 universal cleaning disc	Ø 100 mm	Ø 6 mm	13 mm

6 POWER TOOL ACCESSORIES

6.4 Abrasives



- machine: power drills
- for wood, plastic materials, metals, etc.
- including: 2 sanding belts, grain 80, 150
- packaging: paperboard card
- separate accessories: 2039000



article no.	EAN 4006885...	description	∅	shank	height of grinding tool
2038000	...203808	1 rotary drum sander	∅ 45 mm	∅ 6 mm	30 mm



- for rotary drum sanders ∅ 45 mm
- for wood, plastic materials, metals, etc.
- packaging: paperboard card
- suitable for 2038000, 2521000



article no.	EAN 4006885...	description	∅	grain
2039000	...203907	3 sanding belts	∅ 45 mm	50, 80, 150



- machine: power drills
- for wood, plastic materials, metals, etc.
- including: 1 sanding belt, grain 80
- packaging: paperboard card
- separate accessories: 2246000

article no.	EAN 4006885...	description	∅	shank	height of grinding tool
2245000	...224506	1 rotary drum sander	∅ 75 mm	∅ 8 mm	80 mm



- for rotary drum sander ∅ 75 x 80 mm
- for wood, plastic materials, metals, etc.
- packaging: paperboard card
- suitable for 2245000

article no.	EAN 4006885...	description	∅	grain
2246000	...224605	2 sanding belts	∅ 75 mm	80, 150

POWER TOOL ACCESSORIES 6
6.4 Abrasives

Hand sanding

All-purpose sander



- for sanding sheets 93 x 230 mm
- universally applicable
- for faces and orthogonal angles
- 2-component handle for powerful working without signs of fatigue
- packaging: paperboard card

article no.	EAN	description
5890000	4006885... ...589001	1 all-purpose sander

Surface sander



- for easy fix sanding discs ø 125 mm
- for fast sanding
- high material removal
- 2-component handle for powerful working without signs of fatigue
- with easy-fix fibre for a fast change of the sanding paper
- packaging: paperboard card
- separate accessories: 2208000, 2224000, 2249000, 3169000, 5866000, 5867000, 5876000, 5877000, 8464000



article no.	EAN	description	Ø
5894000	4006885... ...589407	1 surface sander	Ø 125 mm

6 POWER TOOL ACCESSORIES

6.4 Abrasives

Easy fix sanding discs corundum ø 125 mm



- for wood, metals
- high durability
- resin-bonded
- fibre reinforced
- material: corundum
- suitable for 5894000



article no.	EAN	description	Ø	grain	packaging
5866000	4006885... ...586611	5 easy fix sanding discs	Ø 125 mm	40, 60	paperboard card
5867000	4006885... ...586703	5 easy fix sanding discs	Ø 125 mm	80, 120	paperboard card

Polishing



- for applying polishes and waxes
- velour-coated back
- area with easy-fix system
- suitable for 5894000



article no.	EAN	description	Ø	packaging
5876000	4006885... ...587601	1 polishing sponge	Ø 125 mm	paperboard card



- for polishing and high-gloss polishing of paint, non-ferrous metals and chromium steels
- velour-coated back
- area with easy-fix system
- suitable for 5894000



article no.	EAN	description	Ø	packaging
5877000	4006885... ...587700	1 easy fix lambswool bonnet	Ø 125 mm	paperboard card

POWER TOOL ACCESSORIES 6

6.4 Abrasives

Corner sander



- for easy-fix sanding sheets 95 mm
- for filigree workings
- for corners difficult to access and fine sanding
- 2-component handle for powerful working without signs of fatigue
- with easy-fix fibre for a fast change of the sanding paper
- packaging: paperboard card
- separate accessories: 5885000, 5886000, 8469000



article no.	EAN	description	corner measurement
5884000	4006885... ...588400	1 corner sander	95 mm

Easy fix sanding discs corundum corner measurement 95 mm



- for wood, metals
- high durability
- resin-bonded
- fibre reinforced
- material: corundum
- suitable for 3944000, 3996000, 4247000, 5884000



article no.	EAN	description	grain	corner measurement	packaging
5885000	4006885... ...588509	5 easy fix sanding discs	40, 60	95 mm	paperboard card
5886000	4006885... ...588608	5 easy fix sanding discs	80, 120	95 mm	paperboard card

hand-held sanders



- for sanding sheets 93 x 230 mm
- packaging: sticker

article no.	EAN	description	product dimensions
2891000	4006885... ...289109	1 hand-held sander	160 x 85 x 45 mm

6 POWER TOOL ACCESSORIES

6.4 Abrasives



- material: cork
- packaging: paperboard card

article no.	EAN	description	product dimensions
2896000	4006885... ...289604	1 sanding block	123 x 67 x 35 mm



- heavy-duty version
- material: plastic material
- packaging: sticker

article no.	EAN	description	product dimensions
2897000	4006885... ...289703	1 sanding block	130 x 70 x 32 mm



- content:
1 sanding block, plastic material, 130 x 70 mm
50 sanding sheets, 70 x 210 mm, 10 x each grain 40, 60, 80, 100 & 120
- packaging: shrinkwrapped with inlay

article no.	EAN	description	product dimensions
2898000	4006885... ...289802	1 hand sander set 51 pieces	130 x 70 x 32 mm



- content:
1 hand-held sander, 160 x 85 x 45 mm
40 sanding sheets, 93 x 230 mm, 10 x each grain 60, 80, 120, 180
- packaging: shrinkwrapped with inlay

article no.	EAN	description
2877000	4006885... ...287709	1 hand sander set 41 pieces



- hard side for sanding surfaces
- soft side for contour grinding
- with easy-fix fibre for a fast change of the sanding paper
- content:
1 hand-held sander, foam, with easy-fix fibre on two sides, duo sponge, soft and hard, 125 x 70 x 35 mm
3 easy fix sanding sheets, corundum grain 60, 80, 120, with easy-fix fibre, wood, sheet steel, plastic materials, 125 x 70 mm
- packaging: paperboard card
- separate accessories: 2960000, 2961000, 2962000



article no.	EAN	description	product dimensions
2892000	4006885... ...289208	1 hand sander set	125 x 70 x 35 mm

POWER TOOL ACCESSORIES

6.4 Abrasives

6



- for wolcraft hand-held grinder part no. 2892000
- for wood, sheet steel, plastic materials
- version: with easy-fix fibre
- material: corundum
- packaging: paperboard card
- suitable for 2892000



article no.	EAN 4006885...	description	grain	width	length
2960000	...296008	5 easy fix sanding sheets	60	70 mm	125 mm
2961000	...296107	5 easy fix sanding sheets	80	70 mm	125 mm
2962000	...296206	5 easy fix sanding sheets	120	70 mm	125 mm

Sanding blocks



- for all-purpose applications in the household, workshop and for the hobbyist
- for wood, paint/varnish, plastic materials, sheet steel, car bodies
- silicon-carbide coated from 4 sides
- water-resistant
- highly flexible
- packaging: sleeve

article no.	EAN 4006885...	description	grain	product dimensions
2894000	...289406	1 sanding block	40, 80	97 x 25 x 67 mm
2899000	...289901	1 sanding block	80, 120	97 x 25 x 67 mm
8788000	...878808	1 sanding block	80, 120	97 x 25 x 67 mm



- for all-purpose applications in the household, workshop and for the hobbyist
- especially suitable for positions difficult to access and for profile cuts
- for wood, paint/varnish, plastic materials, sheet steel, car bodies
- silicon-carbide coated from 4 sides
- water-resistant
- highly flexible
- packaging: sleeve

article no.	EAN 4006885...	description	grain	product dimensions
2778000	...277809	1 sanding block	60	100 x 25 x 90 mm
2779000	...277908	1 sanding block	120	100 x 25 x 90 mm

6 POWER TOOL ACCESSORIES

6.4 Abrasives

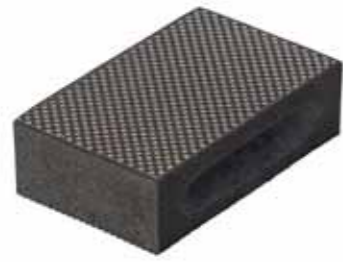

- for removing sharp tile edges after cutting the tile
- material: diamond coated
- packaging: paperboard card

article no.	EAN	description	grain	product dimensions
2887000	4006885... ...288706	1 sanding block	120	90 x 55 mm

Grinding pads



- ideal for contour grinding
- for wood, paint/varnish, plastic materials, sheet steel, car bodies, glass
- packaging: paperboard card

article no.	EAN	description	grain	product dimensions
2895000	4006885... ...289505	3 grinding pads	60, 120, 180	125 x 100 x 10 mm



- ideal for contour grinding
- for wood, paint/varnish, plastic materials, sheet steel, car bodies, glass
- packaging: sleeve

article no.	EAN	description	grain	product dimensions
8789000	4006885... ...878907	1 grinding pad	60	125 x 100 x 10 mm
8790000	...879003	1 grinding pad	120	125 x 100 x 10 mm

POWER TOOL ACCESSORIES 6

6.4 Abrasives

Burnishing pads



- for grinding, de-rusting and polishing stainless steel, steel, aluminium and non-ferrous metal
- for sanding wood
- innovative and highly effective burnishing pad
- fast and gentle cleaning
- adapts perfectly to the workpiece shape
- for wet or dry use
- packaging: paperboard card



article no.	EAN 4006885...	description	version	grain	product dimensions
5898000	...589803	2 burnishing pads	coarse	280	150 x 230 mm
5899000	...589902	2 burnishing pads	medium	360	150 x 230 mm
5900000	...590007	2 burnishing pads	fine	800	150 x 230 mm

Easy fix sanding paper rolls 4 m



- quick and comfortable change of sanding paper thanks to the velour coating
- material: corundum
- packaging: sleeve



article no.	EAN 4006885...	description	grain	width	length
5810000	...581005	1 easy fix sanding paper roll	60	93 mm	4 m
5811000	...581104	1 easy fix sanding paper roll	80	93 mm	4 m
5812000	...581203	1 easy fix sanding paper roll	120	93 mm	4 m
5813000	...581302	1 easy fix sanding paper roll	180	93 mm	4 m
1739000	...173903	1 easy fix sanding paper roll	60	115 mm	4 m
1740000	...174009	1 easy fix sanding paper roll	80	115 mm	4 m
1741000	...174108	1 easy fix sanding paper roll	120	115 mm	4 m
1742000	...174207	1 easy fix sanding paper roll	180	115 mm	4 m

6.4 Abrasives

Wet/dry sanding paper rolls 3 m



- for groove-free wet/dry grinding
- for metals, varnish, coating, plastic materials
- material: silicium-carbide
- packaging: sleeve

article no.	EAN 4006885...	description	grain	width	length
5814000	...581401	1 wet/dry sanding paper roll	280	115 mm	3 m
5815000	...581500	1 wet/dry sanding paper roll	320	115 mm	3 m
5816000	...581609	1 wet/dry sanding paper roll	400	115 mm	3 m
5817000	...581708	1 wet/dry sanding paper roll	600	115 mm	3 m
5818000	...581807	1 wet/dry sanding paper roll	1000	115 mm	3 m

Sanding paper rolls 5 m



- material: corundum
- packaging: sleeve

article no.	EAN 4006885...	description	grain	width	length
3170000	...317000	1 sanding paper roll	40	93 mm	5 m
3171000	...317109	1 sanding paper roll	60	93 mm	5 m
3172000	...317208	1 sanding paper roll	80	93 mm	5 m
3173000	...317307	1 sanding paper roll	100	93 mm	5 m
3174000	...317406	1 sanding paper roll	120	93 mm	5 m
3175000	...317505	1 sanding paper roll	180	93 mm	5 m
3176000	...317604	1 sanding paper roll	240	93 mm	5 m
1770000	...177000	1 sanding paper roll	40	115 mm	5 m
1771000	...177109	1 sanding paper roll	60	115 mm	5 m
1772000	...177208	1 sanding paper roll	80	115 mm	5 m
1773000	...177307	1 sanding paper roll	100	115 mm	5 m
1774000	...177406	1 sanding paper roll	120	115 mm	5 m
1775000	...177505	1 sanding paper roll	180	115 mm	5 m
1776000	...177604	1 sanding paper roll	240	115 mm	5 m

Sanding paper rolls 25 m



- material: corundum
- packaging: sleeve



article no.	EAN 4006885...	description	grain	width	length
2780000	...278004	1 sanding paper roll	40	115 mm	25 m
2781000	...278103	1 sanding paper roll	60	115 mm	25 m
2782000	...278202	1 sanding paper roll	80	115 mm	25 m
2784000	...278400	1 sanding paper roll	120	115 mm	25 m
2786000	...278608	1 sanding paper roll	180	115 mm	25 m

POWER TOOL ACCESSORIES 6

6.4 Abrasives

Sheets of standard sanding paper



- for wood

article no.	EAN 4006885...	description	grain	width	length	packaging
2850000	...285002	1 sheet of standard sanding paper	40	230 mm	280 mm	bulk
2851000	...285101	1 sheet of standard sanding paper	60	230 mm	280 mm	bulk
2852000	...285200	1 sheet of standard sanding paper	80	230 mm	280 mm	bulk
2853000	...285309	1 sheet of standard sanding paper	100	230 mm	280 mm	bulk
2854000	...285408	1 sheet of standard sanding paper	120	230 mm	280 mm	bulk
2856000	...285606	1 sheet of standard sanding paper	180	230 mm	280 mm	bulk
2858000	...285804	1 sheet of standard sanding paper	240	230 mm	280 mm	bulk

Sheets of super sanding paper



- for wood, metals, varnish, plastic materials
- flexible and strong

article no.	EAN 4006885...	description	grain	width	length	packaging
3141000	...314108	16 sheets of super sanding paper	40, 80, 120, 240	230 mm	280 mm	paperboard card



- for wood, metals, varnish, plastic materials
- high durability
- flexible and strong

article no.	EAN 4006885...	description	grain	width	length	packaging
2840000	...284005	1 sheet of super sanding paper	40	230 mm	280 mm	bulk
2841000	...284104	1 sheet of super sanding paper	60	230 mm	280 mm	bulk
2842000	...284203	1 sheet of super sanding paper	80	230 mm	280 mm	bulk
2843000	...284302	1 sheet of super sanding paper	100	230 mm	280 mm	bulk
2844000	...284401	1 sheet of super sanding paper	120	230 mm	280 mm	bulk
2846000	...284609	1 sheet of super sanding paper	180	230 mm	280 mm	bulk
2848000	...284807	1 sheet of super sanding paper	240	230 mm	280 mm	bulk
2845000	...284500	1 sheet of super sanding paper	320	230 mm	280 mm	bulk
2849000	...284906	1 sheet of super sanding paper	400	230 mm	280 mm	bulk

6.4 Abrasives

Sheets of linen-backed sanding paper



- meets high demands
- for wood, metals, plastic materials
 - high durability
 - flexible and strong

article no.	EAN 4006885...	description	grain	width	length	packaging
2860000	...286009	1 sheet of linen-backed sanding paper	40	230 mm	280 mm	bulk
2861000	...286108	1 sheet of linen-backed sanding paper	60	230 mm	280 mm	bulk
2862000	...286207	1 sheet of linen-backed sanding paper	80	230 mm	280 mm	bulk
2863000	...286306	1 sheet of linen-backed sanding paper	100	230 mm	280 mm	bulk
2864000	...286405	1 sheet of linen-backed sanding paper	120	230 mm	280 mm	bulk
2866000	...286603	1 sheet of linen-backed sanding paper	180	230 mm	280 mm	bulk
2868000	...286801	1 sheet of linen-backed sanding paper	240	230 mm	280 mm	bulk
2867000	...286702	1 sheet of linen-backed sanding paper	320	230 mm	280 mm	bulk
2869000	...286900	1 sheet of linen-backed sanding paper	400	230 mm	280 mm	bulk

Sheets of sanding paper wet/dry



- for metals, varnish, coating, plastic materials
- water-resistant

article no.	EAN 4006885...	description	grain	width	length	packaging
2875000	...287501	1 sheet of sanding paper wet/dry	80	230 mm	280 mm	bulk
2879000	...287907	1 sheet of sanding paper wet/dry	100	230 mm	280 mm	bulk
2870000	...287006	1 sheet of sanding paper wet/dry	120	230 mm	280 mm	bulk
2871000	...287105	1 sheet of sanding paper wet/dry	180	230 mm	280 mm	bulk
2872000	...287204	1 sheet of sanding paper wet/dry	280	230 mm	280 mm	bulk
2873000	...287303	1 sheet of sanding paper wet/dry	320	230 mm	280 mm	bulk
2874000	...287402	1 sheet of sanding paper wet/dry	400	230 mm	280 mm	bulk
2876000	...287600	1 sheet of sanding paper wet/dry	600	230 mm	280 mm	bulk
2878000	...287808	1 sheet of sanding paper wet/dry	1000	230 mm	280 mm	bulk
3119000	...311909	16 sheets of sanding paper wet/dry	280, 400, 600, 1000	230 mm	280 mm	paperboard card

Sheets of sanding paper paint/varnish

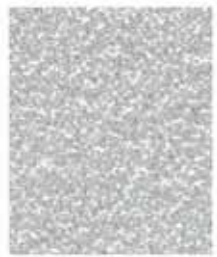

meets high demands

- for painted surfaces, metals, plastic materials
- reduces premature glazing of the graining when grinding paint, varnish and filler
- up to 4 times more durable than standard sanding paper
- special surface coating

article no.	EAN 4006885...	description	grain	width	length	packaging
6010000	...601000	1 sheet of sanding paper paint/varnish	40	230 mm	280 mm	bulk
6011000	...601109	1 sheet of sanding paper paint/varnish	60	230 mm	280 mm	bulk
6012000	...601208	1 sheet of sanding paper paint/varnish	80	230 mm	280 mm	bulk
6013000	...601307	1 sheet of sanding paper paint/varnish	100	230 mm	280 mm	bulk
6014000	...601406	1 sheet of sanding paper paint/varnish	120	230 mm	280 mm	bulk
6015000	...601505	1 sheet of sanding paper paint/varnish	180	230 mm	280 mm	bulk
6016000	...601604	1 sheet of sanding paper paint/varnish	240	230 mm	280 mm	bulk
6017000	...601703	1 sheet of sanding paper paint/varnish	320	230 mm	280 mm	bulk
6018000	...601802	1 sheet of sanding paper paint/varnish	400	230 mm	280 mm	bulk

Steel wool



- packaging: sleeve

article no.	EAN 4006885...	description	degree of fineness	application	weight
6095000	...609501	1 steel wool	000	for grinding, polishing and cleaning wooden, metal, plastic, glass and stone surfaces fine cleaning of wood, gentle intermediate grinding of lacquered surfaces, high-gloss polishing for brass and copper	200 g
6096000	...609600	1 steel wool	00	cleaning of floors, tiles, copper and soiled wooden surfaces fine cleaning of wood, dulling of lacquered surfaces regrinding of wooden floors	200 g
6097000	...609709	1 steel wool	0	cleaning of floors, tiles, aluminium and soiled wooden surfaces grinding of primed and dulled surfaces and wooden floors	200 g
6098000	...609808	1 steel wool	1	cleaning of floors, tiles, metal and soiled wooden surfaces grinding of primed surfaces and wooden floors	200 g

6 POWER TOOL ACCESSORIES

6.4 Abrasives

Polishing



- machine: polishing machines
- for polishing and high-gloss polishing paint, non-ferrous metals and stainless steel with grinding and polishing pastes
- velour-coated back
- packaging: plastic bag with inlay



article no.	EAN	description	Ø
3163000	4006885... ...316300	1 easy fix lambswool bonnet	Ø 180 mm



- machine: polishing machines
- for applying polishes and waxes
- velour-coated back
- packaging: plastic bag with inlay



article no.	EAN	description	Ø
3164000	4006885... ...316409	1 polishing sponge	Ø 180 mm



- machine: eccentric sanders and polishing machines
- for backing pad Ø 150 mm with easy-fix fibre
- for polishing and high-gloss polishing paint, non-ferrous metals and stainless steel with grinding and polishing pastes
- velour-coated back
- packaging: paperboard card



article no.	EAN	description	Ø
3166000	4006885... ...316607	1 easy fix lambswool bonnet	Ø 150 mm



- machine: eccentric sanders and polishing machines
- for backing pad Ø 150 mm with easy-fix fibre
- for applying polishes and waxes
- velour-coated back
- packaging: paperboard card



article no.	EAN	description	Ø
3167000	4006885... ...316706	1 polishing sponge	Ø 150 mm

POWER TOOL ACCESSORIES 6

6.4 Abrasives



- machine: power drills and eccentric sanders
- for backing pads Ø 125 mm with easy-fix fibre
- for polishing and high-gloss polishing of paint, non-ferrous metals and chromium steels
- velour-coated back
- packaging: paperboard card
- suitable for 2211000, 2223000, 5894000



article no.	EAN	description	Ø
2208000	4006885... ...220805	1 easy fix felt polishing disk	Ø 125 mm



- machine: power drills and eccentric sanders
- for backing pads Ø 125 mm with easy-fix fibre
- for polishing and high-gloss polishing paint, non-ferrous metals and stainless steel with grinding and polishing pastes
- velour-coated back
- packaging: paperboard card
- suitable for 2211000, 2223000, 5894000



article no.	EAN	description	Ø
2224000	4006885... ...222403	1 easy fix lambswool bonnet	Ø 125 mm



- machine: power drills and eccentric sanders
- for backing pads Ø 125 mm with easy-fix fibre
- for applying polishes and waxes
- velour-coated back
- packaging: paperboard card
- suitable for 2211000, 2223000, 5894000



article no.	EAN	description	Ø
2249000	4006885... ...224902	1 polishing sponge	Ø 125 mm



- machine: power drills
- for high-gloss polishing
- bore Ø 22.2 mm
- packaging: paperboard card
- separate accessories: 2139000

article no.	EAN	description	Ø	height
2146000	4006885... ...214606	1 cloth disc	Ø 110 mm	20 mm

6 POWER TOOL ACCESSORIES

6.4 Abrasives



- machine: power drills
- for applying polishes and waxes
- bore ø 10 mm
- packaging: paperboard card
- separate accessories: 2116000

article no.	EAN	description	Ø	height
2130000	4006885... ...213005	1 felt buffing wheel	ø 75 mm	10 mm



- machine: power drills
- for pre-polishing
- bore ø 10 mm
- packaging: paperboard card
- separate accessories: 2116000

article no.	EAN	description	Ø	height
2098000	4006885... ...209800	1 sisal knurled brush	ø 85 mm	20 mm



- machine: power drills
- for pre-polishing
- bore ø 10 mm
- packaging: paperboard card
- separate accessories: 2116000

article no.	EAN	description	Ø	height
2132000	4006885... ...213203	1 felt buffing wheel	ø 85 mm	10 mm



- machine: power drills
- for high-gloss polishing with wax and polishing paste
- for chromium, brass, copper, silver, varnish
- packaging: paperboard card

article no.	EAN	description	Ø	shank	height
2131000	4006885... ...213104	1 polishing head	ø 120 mm	ø 8 mm	40 mm

POWER TOOL ACCESSORIES 6

6.4 Abrasives



- machine: power drills
- for backing pad ø 125 mm
- for polishing and high-gloss polishing paint, non-ferrous metals and stainless steel with grinding and polishing pastes
- version: with tightening cord
- packaging: paperboard card
- suitable for 2020000

article no.	EAN	description	Ø
2025000	4006885... ...202504	1 lambswool bonnet	ø 140 mm

Accessories



- brown: for pre-polishing
- blue: for re-polishing
- packaging: blister on card

article no.	EAN	description
2134000	4006885... ...213401	2 polishing pastes



- for sanding and polishing discs without shank
- version: with washers and clamping nuts
- packaging: blister on card

article no.	EAN	description	Ø	shank	bore	suitable for
2116000	4006885... ...211605	1 mandrel	ø 10 mm	ø 6 mm	ø 10 mm	2098000, 2130000, 2132000
2117000	...211704	1 mandrel	ø 13 mm	ø 8 mm	ø 13 mm	
2139000	...213906	1 mandrel	ø 13 mm	ø 8 mm	ø 13, 22.2 mm	2146000

Assortments



- content:
 - 1 felt buffing wheel, ø 85 mm
 - 1 felt buffing wheel, ø 85 mm
 - 2 polishing pastes
 - 1 mandrel
- packaging: blister on card

article no.	EAN	description
2178000	4006885... ...217805	1 hobby polishing set

6 POWER TOOL ACCESSORIES

6.4 Abrasives



- content:
2 felt buffing wheels, ø 85 mm
1 sisal knurled brush, ø 85 mm
2 polishing pastes
1 mandrel
- packaging: blister on card

article no.	EAN	description
2179000	4006885... ...217904	1 professional polishing set



- for applying polishes and waxes
- content:
1 polishing sponge, ø 125 mm
1 easy fix lambswool bonnet, ø 125 mm
1 hand fleece disc, ø 125 mm
- packaging: paperboard card



article no.	EAN	description
3165000	4006885... ...316508	1 hand polishing set

Mounted stones



- for metals, glass, ceramics, plastic materials
- according to EN 12413
- material: aluminium oxide
- minimum clamping depth 15 mm
- packaging: blister on card

article no.	EAN	description	Ø	form	height of grinding tool	shank
2170000	4006885... ...217003	1 mounted stone	ø 24 mm	spherical	23 mm	ø 6 mm
2171000	...217102	1 mounted stone	ø 12 mm	cylindrical	22 mm	ø 6 mm
2172000	...217201	1 mounted stone	ø 24 mm	cylindrical	15 mm	ø 6 mm
2173000	...217300	1 mounted stone	ø 10 - 20 mm	conical	30 mm	ø 6 mm
2174000	...217409	1 mounted stone	ø 20 mm	cylindric-conical	30 mm	ø 6 mm
2144000	...214408	5 mounted stones	ø 24 mm	spherical	23 mm	ø 6 mm
			ø 12 mm	cylindrical	22 mm	
			ø 24 mm	cylindrical	15 mm	
			ø 10 - 20 mm	conical	30 mm	
			ø 20 mm	cylindric-conical	30 mm	

POWER TOOL ACCESSORIES

6.4 Abrasives

6



- for metals, glass, ceramics, plastic materials
- according to EN 12413
- material: aluminium oxide
- minimum clamping depth 15 mm
- packaging: blister on card

article no.	EAN 4006885...	description	Ø	form	height of grinding tool	shank
2142000	...214200	5 mounted stones	Ø 14 mm	cylindrical	15 mm	Ø 3 mm
			Ø 16 mm	conical	20 mm	
			Ø 13 mm	cylindric-conical	16 mm	
			Ø 10 mm	conical curved	14 mm	
			Ø 16 mm	cylindrical	8 mm	



- version: with grinding rest
- packaging: blister on card

article no.	EAN 4006885...	description	Ø	shank
2140000	...214002	1 knife and scissor sharpener	Ø 60 mm	Ø 6 mm



- for sharpening of chains for saw chains
- max. 12,000 RPM
- packaging: blister on card
- complementary products: 5121000

article no.	EAN 4006885...	description	Ø	height of grinding tool	shank
2175000	...217508	3 mounted points	Ø 4, 4.8, 5.5 mm	12 mm	Ø 2.3 mm



- for smoothing of grinding wheels
- packaging: blister on card

article no.	EAN 4006885...	description
4105000	...410503	1 grinding wheel dresser

6 POWER TOOL ACCESSORIES

6.4 Abrasives

Assortments



- for refurbishing exterior metal surfaces
- content:
 - 1 hand wire brush, for rough precleaning, 125 mm
 - 1 wire wheel brush, \varnothing 75 mm, for removing rust and paint on surfaces
 - 1 wire spiral brush, \varnothing 28 mm, for remove rust and paint in corners
 - 1 flap wheel burnishing mop, \varnothing 80 mm, for removing dirt
 - 1 burnishing pad, for final precision processing, 115 x 75 mm
- packaging: double card with inlaid blister

article no.	EAN	description
5641000	4006885... ...564107	1 metalworking set, 5-piece



- for refurbishing exterior wooden objects
- content:
 - 1 flap wheel burnishing mop, \varnothing 80 mm, for sanding large surfaces
 - 1 flap wheel burnishing mop, \varnothing 50 mm, for processing smaller surfaces
 - 1 corner sander, for areas difficult to access, 95 mm
 - 3 easy fix sanding discs, grain 40, 80, 120, 95 mm
 - 1 burnishing pad, for final precision processing, 115 x 75 mm
- packaging: double card with inlaid blister

article no.	EAN	description
5642000	4006885... ...564206	1 woodworking set, 7-piece



- for restoring wooden items of furniture
- content:
 - 1 flap wheel burnishing mop, \varnothing 80 mm, for sanding large surfaces
 - 1 rotary flap wheel sander, \varnothing 20 mm, for processing small surfaces and corners
 - 1 hand-held sander, with easy-fix fibre on two sides, 125 x 70 x 35 mm
 - 3 easy fix sanding sheets, corundum grain 60, 80, 120
 - 1 steel wool pad, for final finishing, 175 x 75 mm
- packaging: double card with inlaid blister

article no.	EAN	description
5643000	4006885... ...564305	1 furniture renovation set, 7-piece

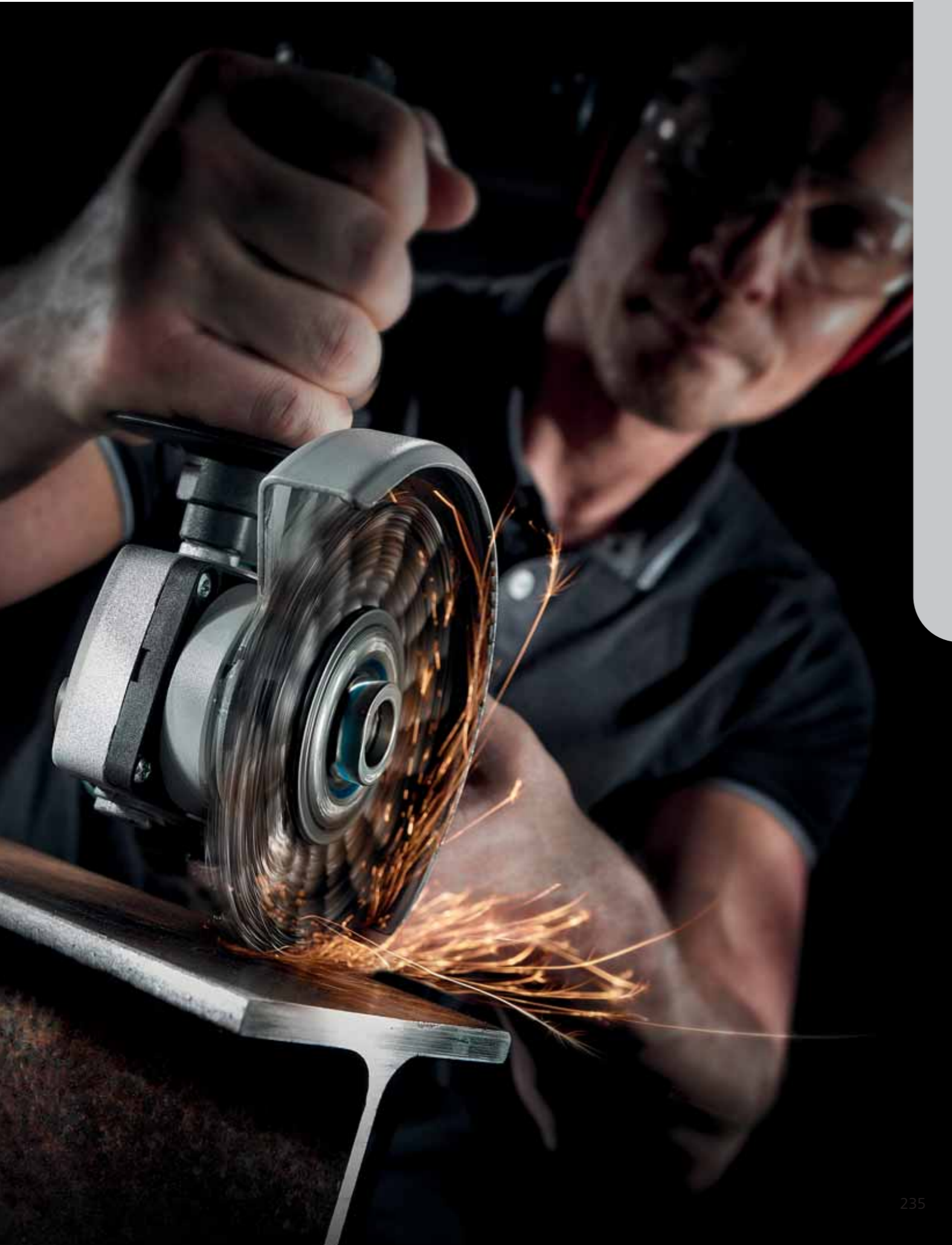

6.5 Brushes

Power drills

Steel wire brushes



- machine: power drills
- for de-rusting and cleaning
- for the preparation of soldering and welding jobs
- for metals, sheet steel
- according to EN 1083-2
- material: steel wire

article no.	EAN 4006885...	description	Ø	shank	shank	wire fill width	version	packaging
2709000	...270909	1 wire wheel brush	Ø 38 mm	hexagon shank 1/4" (6,35 mm)		8 mm	wavy	blister on card
2710000	...271005	1 wire wheel brush	Ø 50 mm	hexagon shank 1/4" (6,35 mm)		8 mm	wavy	blister on card
2100000	...210004	1 wire wheel brush	Ø 75 mm	hexagon shank 1/4" (6,35 mm)		10 mm	wavy	blister on card
2119000	...211902	1 wire wheel brush	Ø 75 mm	hexagon shank 1/4" (6,35 mm)		15 mm	twisted	blister on card
2101000	...210103	1 wire wheel brush	Ø 75 mm	hexagon shank 1/4" (6,35 mm)		16 mm	wavy	blister on card
8470000	...847002	1 wire wheel brush	Ø 75 mm	round shank	Ø 6 mm	7 mm	wavy	bulk
2102000	...210202	1 wire wheel brush	Ø 100 mm	hexagon shank 1/4" (6,35 mm)		10 mm	wavy	blister on card
2103000	...210301	1 wire wheel brush	Ø 100 mm	hexagon shank 1/4" (6,35 mm)		16 mm	wavy	blister on card
8471000	...847101	1 wire wheel brush	Ø 100 mm	round shank	Ø 6 mm	7 mm	wavy	bulk



- machine: power drills
- for de-rusting and cleaning
- for the preparation of soldering and welding jobs
- for metals, sheet steel
- according to EN 1083-2
- material: steel wire

article no.	EAN 4006885...	description	Ø	shank	shank	version	packaging
2106000	...210608	1 wire cup brush	Ø 50 mm	hexagon shank 1/4" (6,35 mm)		wavy	blister on card
8472000	...847200	1 wire cup brush	Ø 50 mm	round shank	Ø 6 mm	wavy	bulk
2704000	...270404	1 wire cup brush	Ø 75 mm	hexagon shank 1/4" (6,35 mm)		twisted	blister on card
2108000	...210806	1 wire cup brush	Ø 75 mm	hexagon shank 1/4" (6,35 mm)		wavy	blister on card



POWER TOOL ACCESSORIES

6

6.5 Brushes



article no.	EAN 4006885...	description	Ø	shank	shank	version	packaging
8473000	...847309	1 wire cup brush	Ø 75 mm	round shank	Ø 6 mm	wavy	bulk
2109000	...210905	1 wire cup brush	Ø 80 mm	hexagon shank 1/4" (6,35 mm)		wavy	blister on card



- machine: power drills
- ideal for interior piping or large holes
- for de-rusting and cleaning
- for the preparation of soldering and welding jobs
- for metals, sheet steel
- according to EN 1083-2
- material: steel wire
- packaging: blister on card

article no.	EAN 4006885...	description	Ø	shank	shank	wire fill width	length
2127000	...212701	1 wire spiral brush	Ø 20 mm	round shank	Ø 8 mm	55 mm	200 mm
2104000	...210400	1 wire spiral brush	Ø 28 mm	round shank	Ø 6 mm	60 mm	95 mm
2128000	...212800	1 wire spiral brush	Ø 38 mm	round shank	Ø 8 mm	55 mm	200 mm



- machine: power drills
- for de-rusting and cleaning
- ideal for interior piping or large holes
- for metals, sheet steel
- according to EN 1083-2
- material: steel wire
- Wire length 25 mm

article no.	EAN 4006885...	description	Ø	shank	shank	version	packaging
2126000	...212602	1 wire end brush	Ø 25 mm	hexagon shank 1/4" (6,35 mm)		wavy	blister on card
8474000	...847408	1 wire end brush	Ø 25 mm	round shank	Ø 6 mm	wavy	bulk

6 POWER TOOL ACCESSORIES

6.5 Brushes



- for flexible shafts and mini power drills
- for metals, sheet steel, wood
- according to EN 1083-2
- material: steel wire
- content:
 - 1 wheel mini brush, \varnothing 20 mm
 - 1 cup mini brush, \varnothing 15 mm
 - 1 wire end mini brush, \varnothing 5 mm
- packaging: blister on card

article no.	EAN	description	shank	shank
2114000	4006885... ...211407	1 mini brush set	round shank	\varnothing 2.35 mm



- machine: power drills
- for de-rusting and cleaning
- for the preparation of soldering and welding jobs
- for metals, sheet steel
- according to EN 1083-2
- material: steel wire
- content:
 - 1 wire wheel brush, \varnothing 75 x 10 mm
 - 1 wire cup brush, \varnothing 75 mm
 - 1 wire spiral brush, \varnothing 28 x 60 x 95 mm
 - 1 wire end brush, \varnothing 25 mm
- packaging: blister on card

article no.	EAN	description	shank	shank
2133000	4006885... ...213302	1 wire brush set	round shank	\varnothing 6 mm

POWER TOOL ACCESSORIES 6

6.5 Brushes

Brass wire brushes



- machine: power drills
- for all fine grinding and polishing jobs
- for non-ferrous metals
- according to EN 1083-2
- material: brass wire

article no.	EAN	description	Ø	shank	shank	wire fill width	packaging
2110000	...211001	1 wire wheel brush	Ø 75 mm	hexagon shank 1/4" (6,35 mm)		10 mm	blister on card
8475000	...847507	1 wire wheel brush	Ø 75 mm	round shank	Ø 6 mm	7 mm	bulk



- machine: power drills
- for all fine grinding and polishing jobs
- for non-ferrous metals
- according to EN 1083-2
- material: brass wire
- Wire length 15 mm
- packaging: blister on card

article no.	EAN	description	Ø	shank
2112000	...211209	1 wire cup brush	Ø 50 mm	hexagon shank 1/4" (6,35 mm)



- machine: power drills
- for all fine grinding and polishing jobs
- for non-ferrous metals
- according to EN 1083-2
- material: brass wire
- Wire length 25 mm
- packaging: blister on card

article no.	EAN	description	Ø	shank
2738000	...273801	1 wire end brush	Ø 25 mm	hexagon shank 1/4" (6,35 mm)



- machine: power drills
- for all fine grinding and polishing jobs
- for structuring wood
- for wood, wooden beams, panels
- according to EN 1083-2
- material: brass coated wire
- packaging: blister on card

article no.	EAN	description	Ø	shank	shank	wire fill width
2265000	...226500	1 wood grain brush	Ø 80 mm	round shank	Ø 8 mm	35 mm

6 POWER TOOL ACCESSORIES

6.5 Brushes



- for flexible shafts and mini power drills
- for all fine grinding and polishing jobs
- for non-ferrous metals
- according to EN 1083-2
- material: brass wire
- content:
 - 1 wheel mini brush, \varnothing 20 mm
 - 1 cup mini brush, \varnothing 15 mm
 - 1 wire end mini brush, \varnothing 5 mm
- packaging: blister on card

article no.	EAN	description	shank	shank
2740000	4006885... ...274006	1 mini brush set	round shank	\varnothing 2.35 mm



- machine: power drills
- for all fine grinding and polishing jobs
- for non-ferrous metals
- according to EN 1083-2
- material: brass wire
- content:
 - 1 wire wheel brush, \varnothing 75 x 7 mm
 - 1 wire cup brush, \varnothing 45 mm
 - 1 wire end brush, \varnothing 25 mm
- packaging: blister on card

article no.	EAN	description	shank	shank
2739000	4006885... ...273900	1 wire brush set	round shank	\varnothing 6 mm

Nylon brushes



- machine: power drills
- for cleaning, de-rusting, polishing
- for wood
- a considerably longer service life than any wire brushes
- aggressive thanks to its coarse-grain nylon wires
- according to EN 1083-2
- material: nylon wire

article no.	EAN	description	\varnothing	shank	shank	wire fill width	packaging
1500000	4006885... ...150003	1 nylon wheel brush	\varnothing 75 mm	hexagon shank 1/4" (6,35 mm)		10 mm	fixed on card
1502000	...150201	1 nylon wheel brush	\varnothing 100 mm	hexagon shank 1/4" (6,35 mm)		10 mm	fixed on card
8477000	...847705	1 nylon wheel brush	\varnothing 100 mm	round shank	\varnothing 6 mm	8 mm	bulk

POWER TOOL ACCESSORIES 6

6.5 Brushes



- machine: power drills
- for cleaning, de-rusting, polishing
- for wood
- a considerably longer service life than any wire brushes
- aggressive thanks to its coarse-grain nylon wires
- according to EN 1083-2
- material: nylon wire
- Wire length 20 mm

article no.	EAN 4006885...	description	Ø	shank	shank	packaging
1505000	...150508	1 nylon cup brush	Ø 50 mm	hexagon shank 1/4" (6,35 mm)		fixed on card
1506000	...150607	1 nylon cup brush	Ø 65 mm	hexagon shank 1/4" (6,35 mm)		fixed on card
8478000	...847804	1 nylon cup brush	Ø 65 mm	round shank	Ø 6 mm	bulk



- machine: power drills
- for cleaning, de-rusting, polishing
- for wood
- a considerably longer service life than any wire brushes
- aggressive thanks to its coarse-grain nylon wires
- according to EN 1083-2
- material: nylon wire
- Wire length 25 mm
- packaging: fixed on card

article no.	EAN 4006885...	description	Ø	shank
1510000	...151000	1 nylon end brush	Ø 25 mm	hexagon shank 1/4" (6,35 mm)

6 POWER TOOL ACCESSORIES

6.5 Brushes

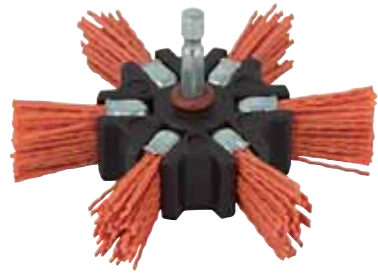

- machine: power drills
- for cleaning, de-rusting, polishing
- for wood
- a considerably longer service life than any wire brushes
- aggressive thanks to its coarse-grain nylon wires
- according to EN 1083-2
- material: nylon wire
- packaging: fixed on card

article no.	EAN	description	Ø	shank	wire fill width
1512000	4006885... ...151208	1 nylon rotary flap wheel	Ø 100 mm	hexagon shank 1/4" (6,35 mm)	20 mm

Assortments



- machine: power drills
- for cleaning, de-rusting, polishing
- for wood
- a considerably longer service life than any wire brushes
- aggressive thanks to its coarse-grain nylon wires
- according to EN 1083-2
- material: nylon wire
- content:
 - 1 nylon wheel brush, Ø 75 x 10 mm
 - 1 nylon cup brush, Ø 65 mm
 - 1 nylon end brush, Ø 25 mm
- packaging: blister on card

article no.	EAN	description	shank	shank
2741000	4006885... ...274105	1 nylon brush set	round shank	Ø 6 mm

POWER TOOL ACCESSORIES 6

6.5 Brushes



- machine: power drills
- for cleaning and gentle polishing
- for wood
- non-aggressive thanks to its fine grain nylon wires
- according to EN 1083-2
- material: nylon wire
- packaging: fixed on card

article no.	EAN	description	Ø	shank	wire fill width
2726000	...272606	1 nylon wheel brush	ø 75 mm	hexagon shank 1/4" (6,35 mm)	10 mm
2727000	...272705	1 nylon wheel brush	ø 100 mm	hexagon shank 1/4" (6,35 mm)	10 mm



- machine: power drills
- for cleaning and gentle polishing
- for wood
- non-aggressive thanks to its fine grain nylon wires
- according to EN 1083-2
- material: nylon wire
- Wire length 20 mm
- packaging: fixed on card

article no.	EAN	description	Ø	shank
2728000	...272804	1 nylon cup brush	ø 50 mm	hexagon shank 1/4" (6,35 mm)
2729000	...272903	1 nylon cup brush	ø 65 mm	hexagon shank 1/4" (6,35 mm)

6 POWER TOOL ACCESSORIES

6.5 Brushes

Stainless steel wire brushes



- machine: power drills
- for the preparation of soldering and welding jobs
- for de-rusting and cleaning
- for stainless steel
- durable and non-corrosive (does not leave any corrosive residuals on the treated workpiece)
- according to EN 1083-2
- material: stainless steel wire
- packaging: blister on card

article no.	EAN	description	Ø	shank	wire fill width
2711000	4006885... ...271104	1 stainless steel wire wheel brush	ø 75 mm	hexagon shank 1/4" (6,35 mm)	12 mm



- machine: power drills
- for the preparation of soldering and welding jobs
- for de-rusting and cleaning
- for stainless steel
- durable and non-corrosive (does not leave any corrosive residuals on the treated workpiece)
- according to EN 1083-2
- material: stainless steel wire
- Wire length 20 mm
- packaging: blister on card

article no.	EAN	description	Ø	shank
2746000	4006885... ...274600	1 stainless steel wire cup brush	ø 75 mm	hexagon shank 1/4" (6,35 mm)

POWER TOOL ACCESSORIES 6

6.5 Brushes



- for flexible shafts and mini power drills
- for the preparation of soldering and welding jobs
- for de-rusting and cleaning
- for stainless steel
- durable and non-corrosive (does not leave any corrosive residuals on the treated workpiece)
- according to EN 1083-2
- material: stainless steel wire
- content:
 - 1 wheel mini brush, \varnothing 20 mm
 - 1 cup mini brush, \varnothing 15 mm
 - 1 wire end mini brush, \varnothing 5 mm
- packaging: blister on card

article no.	EAN	description	shank	shank
2747000	4006885... ...274709	1 stainless steel mini brush set	round shank	\varnothing 2.35 mm

Special brushes



- machine: power drills
- for roughing suede, nubuck
- for polishing soft-wood furniture - removes wax polish carefully
- for cleaning profiled sections and wood
- for polishing metals
- with soft bristles
- according to EN 1083-2
- packaging: fixed on card

article no.	EAN	description	\varnothing	shank	shank
2713000	4006885... ...271302	1 polishing brush	\varnothing 80 mm	round shank	\varnothing 6 mm

6.5 Brushes

Angle grinders

Steel wire brushes



- machine: angle grinders
- for de-rusting and cleaning
- for the preparation of soldering and welding jobs
- for metals, sheet steel
- according to EN 1083-2
- material: steel wire
- packaging: blister on card

article no.	EAN 4006885...	description	Ø	thread	bore	wire fill width	version
2148000	...214804	1 wire wheel brush	Ø 115 mm		Ø 22.2 mm	15 mm	twisted
2149000	...214903	1 wire wheel brush	Ø 115 mm	M 14		15 mm	twisted



- machine: angle grinders
- for de-rusting and cleaning
- for the preparation of soldering and welding jobs
- for metals, sheet steel
- according to EN 1083-2
- material: steel wire

article no.	EAN 4006885...	description	Ø	thread	version	packaging
2107000	...210707	1 wire cup brush	Ø 70 mm	M 14	wavy	double blister on card
8479000	...847903	1 wire cup brush	Ø 70 mm	M 14	wavy	bulk
2125000	...212503	1 wire cup brush	Ø 75 mm	M 14	twisted	double blister on card
8476000	...847606	1 wire cup brush	Ø 75 mm	M 14	twisted	bulk
2150000	...215009	1 wire cup brush	Ø 90 mm	M 14	twisted	double blister on card
2151000	...215108	1 wire cup brush	Ø 100 mm	M 14	wavy	double blister on card



- machine: angle grinders
- for de-rusting and cleaning
- for the preparation of soldering and welding jobs
- for metals, sheet steel
- according to EN 1083-2
- material: steel wire
- packaging: double blister on card

article no.	EAN 4006885...	description	Ø	thread	wire fill width	version
2705000	...270503	1 conical wire brush	Ø 100 mm	M 14	15 mm	wavy
2153000	...215306	1 conical wire brush	Ø 100 mm	M 14	15 mm	twisted

POWER TOOL ACCESSORIES 6

6.5 Brushes

Stainless steel wire brushes



- machine: angle grinders
- for de-rusting and cleaning
- for the preparation of soldering and welding jobs
- for stainless steel
- durable and non-corrosive (does not leave any corrosive residuals on the treated workpiece)
- according to EN 1083-2
- material: stainless steel wire
- packaging: double blister on card

article no.	EAN	description	Ø	thread	wire fill width	version
2701000	4006885... ...270107	1 stainless steel wire wheel brush	Ø 100 mm	M 14	15 mm	twisted



- machine: angle grinders
- for de-rusting and cleaning
- for the preparation of soldering and welding jobs
- for stainless steel
- durable and non-corrosive (does not leave any corrosive residuals on the treated workpiece)
- according to EN 1083-2
- material: stainless steel wire
- Wire length 20 mm
- packaging: double blister on card

article no.	EAN	description	Ø	thread	version
2702000	4006885... ...270206	1 stainless steel wire cup brush	Ø 70 mm	M 14	wavy
2700000	...270008	1 stainless steel wire cup brush	Ø 75 mm	M 14	twisted

6.5 Brushes

Brass wire brushes



- machine: angle grinders
- for all fine grinding and polishing jobs
- for non-ferrous metals
- according to EN 1083-2
- material: brass wire
- Wire length 20 mm

article no.	EAN	description	Ø	thread	version
2748000	4006885... ...274808	1 wire cup brush	ø 70 mm	M 14	wavy

Hand wire brushes



- version: with plastic handle
- Wire length 30 mm
- Bristle length 125 mm
- packaging: fixed on card

article no.	EAN	description	for	material	length
2715000	4006885... ...271500	1 hand wire brush	metals, sheet steel, wood, stone	steel wire	265 mm
2716000	...271609	1 hand wire brush	non-ferrous metals, wood, stone	brass wire	265 mm
2717000	...271708	1 hand wire brush	stainless steel, metals, non-ferrous metals	stainless steel wire	265 mm
2764000	...276406	1 hand wire brush	metals, non-ferrous metals, wood, stone	nylon wire	265 mm



- for de-rusting and cleaning
- for the cleaning and grinding of stainless steel railings, welding seams, spark plugs, etc.
- version: with plastic handle
- Wire length 30 mm
- Bristle length 125 mm
- content:
 - 1 hand wire brush, steel wire
 - 1 hand wire brush, stainless steel wire
 - 1 hand wire brush, brass wire
- packaging: fixed on card

article no.	EAN	description	length
2138000	4006885... ...213807	1 hand wire brushes set	265 mm

POWER TOOL ACCESSORIES

6.5 Brushes

6



- for stainless steel, metals, non-ferrous metals
- version: with plastic handle
- Bristle length 160 mm
- packaging: fixed on card

article no.	EAN	description	Ø	material	length
2750000	4006885... ...275003	1 grill brush	Ø 30 mm	stainless steel wire	300 mm



- for cleaning tile joints
- version: with plastic handle
- Wire length 18 mm
- packaging: fixed on card

article no.	EAN	description	edging	material	length
2765000	4006885... ...276505	1 Tile joint brush	3 rows	nylon wire	180 mm



- for metals, sheet steel, wood, stone
- version: with wooden handle, candle shape
- Wire length 20 mm
- Bristle length 60 mm
- packaging: fixed on card

article no.	EAN	description	edging	material	length
2718000	4006885... ...271807	1 hand wire brush	3 rows	steel wire	200 mm



- for metals, sheet steel, wood, stone
- version: with wooden handle
- Wire length 6 mm
- Bristle length 115 mm
- packaging: fixed on card

article no.	EAN	description	material	product dimensions
2719000	4006885... ...271906	1 file brush	steel wire	40 x 253 mm



- for metals, sheet steel, wood, stone
- version: with wooden handle
- Wire length 35 mm
- Bristle length 150 mm
- packaging: fixed on card

article no.	EAN	description	edging	material	length
2720000	4006885... ...272002	1 violin brush	5 rows	steel wire	205 mm

6 POWER TOOL ACCESSORIES

6.5 Brushes



- for non-ferrous metals, metals, wood, stone
- version: with wooden handle
- Wire length 35 mm
- Bristle length 150 mm
- packaging: fixed on card

article no.	EAN	description	edging	material	length
2721000	4006885... ...272101	1 violin brush	5 rows	brass coated wire	205 mm



- for metals, sheet steel, wood, stone
- version: with wooden handle
- Wire length 23 mm
- Bristle length 140 mm
- packaging: fixed on card

article no.	EAN	description	edging	material	length
2722000	4006885... ...272200	1 hand wire brush	4 rows	steel wire	280 mm



- for metals, sheet steel, wood, stone
- version: with wooden handle
- Wire length 23 mm
- Bristle length 140 mm
- packaging: fixed on card

article no.	EAN	description	edging	material	length
2723000	4006885... ...272309	1 hand wire brush	4 rows	corrugated steel wire	280 mm



- for non-ferrous metals, wood, stone
- version: with wooden handle
- Wire length 15 mm
- Bristle length 110 mm
- packaging: fixed on card

article no.	EAN	description	edging	material	length
2724000	4006885... ...272408	1 fine wire brush	4 rows	brass wire	220 mm



- for non-ferrous metals, wood, stone
- version: with wooden handle
- Wire length 20 mm
- Bristle length 60 mm
- packaging: fixed on card

article no.	EAN	description	edging	material	length
2725000	4006885... ...272507	1 hand wire brush	3 rows	brass wire	200 mm



6.6 Saw blades

Circular hand saw blades

Purple series - fast, medium-coarse cuts



- multi-purpose saw blade for heavy-duty applications
- length and cross cuts
- for wood, wood with nails, plastic materials, thin steel profiles, non-ferrous metals
- tear-free cutting edges
- noise insulation by laser slots
- material: TCT
- surface bright polished
- shot-blasted tooth rim, special tooth
- alternate tooth
- quality of cut: fast, medium-coarse cuts
- packaging: double card with inlaid blister

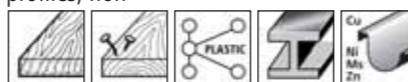

article no.	EAN	description	Ø	bore	cutting width	teeth
6567000	...656703	1 circular saw blade	Ø 160 mm	Ø 16 mm	2.8 mm	24
6568000	...656802	1 circular saw blade	Ø 160 mm	Ø 20 mm	2.8 mm	24
6577000	...657700	1 circular saw blade	Ø 190 mm	Ø 30 mm	2.8 mm	30
6581000	...658103	1 circular saw blade	Ø 210 mm	Ø 30 mm	2.8 mm	34

Purple series - fine, clean cuts



- multi-purpose saw blade for heavy-duty applications
- length and cross cuts
- for wood, wood with nails, plastic materials, thin steel profiles, non-ferrous metals
- tear-free cutting edges
- noise insulation by laser slots
- material: TCT
- surface bright polished
- trapezoidal tooth/flat tooth
- quality of cut: fine, clean cuts
- packaging: double card with inlaid blister

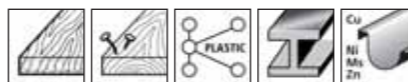

article no.	EAN	description	Ø	bore	cutting width	teeth
6620000	...662001	1 circular saw blade	Ø 160 mm	Ø 20, 16 mm	2.5 mm	48
6621000	...662100	1 circular saw blade	Ø 165 mm	Ø 20, 16 mm	2.5 mm	48
6622000	...662209	1 circular saw blade	Ø 184 mm	Ø 20, 16 mm	2.5 mm	56
6623000	...662308	1 circular saw blade	Ø 190 mm	Ø 20, 16 mm	2.5 mm	56
6624000	...662407	1 circular saw blade	Ø 190 mm	Ø 30 mm	2.5 mm	56
6625000	...662506	1 circular saw blade	Ø 235 mm	Ø 30 mm	2.5 mm	64

POWER TOOL ACCESSORIES 6

6.6 Saw blades

Silver series - easy, fast cuts



- longitudinal cuts
- for chipboards, plywood, coated wood and chipboards, single-sided veneered boards
- with diamond-ground carbide-tipped teeth
- firm, tear-free cutting edges
- noise insulation by laser slots and a reduced thickness of the saw blade body
- material: TCT
- surface brightly polished
- shot-blasted tooth rim, laser and cooling slots
- flat concave tooth (hollow face)
- quality of cut: easy, fast cuts
- packaging: double card with inlaid blister



article no.	EAN 4006885...	description	Ø	bore	cutting width	teeth
6456000	...645608	1 circular saw blade	Ø 130 mm	Ø 16 mm	2.4 mm	20
6458000	...645806	1 circular saw blade	Ø 140 mm	Ø 12.75 mm	2.4 mm	20
6463000	...646308	1 circular saw blade	Ø 150 mm	Ø 16 mm	2.4 mm	24
6464000	...646407	1 circular saw blade	Ø 150 mm	Ø 20 mm	2.4 mm	24
6466000	...646605	1 circular saw blade	Ø 156.5 mm	Ø 12.75 mm	2.4 mm	24
6467000	...646704	1 circular saw blade	Ø 160 mm	Ø 16 mm	2.4 mm	24
6468000	...646803	1 circular saw blade	Ø 160 mm	Ø 20 mm	2.4 mm	24
6472000	...647206	1 circular saw blade	Ø 180 mm	Ø 20 mm	2.6 mm	28
6473000	...647305	1 circular saw blade	Ø 184 mm	Ø 16 mm	2.6 mm	28
6475000	...647503	1 circular saw blade	Ø 190 mm	Ø 16 mm	2.6 mm	28
6476000	...647602	1 circular saw blade	Ø 190 mm	Ø 20 mm	2.6 mm	28
6477000	...647701	1 circular saw blade	Ø 190 mm	Ø 30 mm	2.6 mm	28
6481000	...648104	1 circular saw blade	Ø 210 mm	Ø 30 mm	2.6 mm	32

6.6 Saw blades

Orange series - fine, clean cuts



- length and cross cuts
- for natural woods, fibre boards, profiled boards, panels
- firm, tear-free cutting edges
- material: TCT
- surface bright polished
- shot-blasted tooth rim
- multi-alternate tooth (teeth alternately ground)
- quality of cut: fine, clean cuts
- packaging: double card with inlaid blister

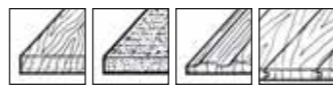

article no.	EAN 4006885...	description	Ø	bore	cutting width	teeth
6630000	...663008	1 circular saw blade	Ø 160 mm	Ø 20, 16 mm	2.6 mm	48
6631000	...663107	1 circular saw blade	Ø 165 mm	Ø 20, 16 mm	2.6 mm	48
6632000	...663206	1 circular saw blade	Ø 184 mm	Ø 20, 16 mm	2.6 mm	56
6633000	...663305	1 circular saw blade	Ø 190 mm	Ø 20, 16 mm	2.6 mm	56
6634000	...663404	1 circular saw blade	Ø 190 mm	Ø 30 mm	2.6 mm	56
6635000	...663503	1 circular saw blade	Ø 235 mm	Ø 30 mm	3 mm	64

Green series - fast, medium-coarse cuts



- length and cross cuts
- for wood, chipboards, plywood, wood core chipboards, profiled boards
- material: TCT
- alternate tooth
- quality of cut: fast, medium-coarse cuts
- packaging: double card with inlaid blister

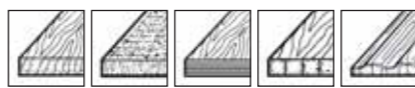

article no.	EAN 4006885...	description	Ø	bore	cutting width	teeth
6355000	...635500	1 circular saw blade	Ø 127 mm	Ø 12.75 mm	2.4 mm	18
6356000	...635609	1 circular saw blade	Ø 130 mm	Ø 16 mm	2.4 mm	18
6358000	...635807	1 circular saw blade	Ø 140 mm	Ø 12.75 mm	2.4 mm	18
6359000	...635906	1 circular saw blade	Ø 140 mm	Ø 20 mm	2.4 mm	18
6363000	...636309	1 circular saw blade	Ø 150 mm	Ø 16 mm	2.4 mm	20
6364000	...636408	1 circular saw blade	Ø 150 mm	Ø 20 mm	2.4 mm	20
6366000	...636606	1 circular saw blade	Ø 156.5 mm	Ø 12.75 mm	2.4 mm	20
6367000	...636705	1 circular saw blade	Ø 160 mm	Ø 16 mm	2.4 mm	20
6368000	...636804	1 circular saw blade	Ø 160 mm	Ø 20 mm	2.4 mm	20
6365000	...636507	1 circular saw blade	Ø 165 mm	Ø 20, 16 mm	2.4 mm	20
6372000	...637207	1 circular saw blade	Ø 180 mm	Ø 20 mm	2.4 mm	22
6373000	...637306	1 circular saw blade	Ø 184 mm	Ø 16 mm	2.4 mm	22
6375000	...637504	1 circular saw blade	Ø 190 mm	Ø 16 mm	2.4 mm	30
6376000	...637603	1 circular saw blade	Ø 190 mm	Ø 20 mm	2.4 mm	30
6377000	...637702	1 circular saw blade	Ø 190 mm	Ø 30 mm	2.4 mm	30
6379000	...637900	1 circular saw blade	Ø 200 mm	Ø 30 mm	2.4 mm	30
6381000	...638105	1 circular saw blade	Ø 210 mm	Ø 30 mm	2.4 mm	30



POWER TOOL ACCESSORIES

6.6 Saw blades

6



article no.	EAN	description	∅	bore	cutting width	teeth
6385000	4006885... ...638501	1 circular saw blade	∅ 235 mm	∅ 30 mm	3.2 mm	34

Brown series - fast, rough cuts



- length and cross cuts
- for wood, chipboards
- material: TCT
- surface ground
- shot-blasted tooth rim
- alternate tooth
- quality of cut: fast, rough cuts
- packaging: double card with inlaid blister

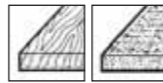

article no.	EAN	description	∅	bore	cutting width	teeth
6730000	4006885... ...673007	1 circular saw blade	∅ 130 mm	∅ 16 mm	2.4 mm	18
6731000	...673106	1 circular saw blade	∅ 140 mm	∅ 12.75 mm	2.4 mm	18
6738000	...673809	1 circular saw blade	∅ 150 mm	∅ 16 mm	2.4 mm	20
6732000	...673205	1 circular saw blade	∅ 150 mm	∅ 20 mm	2.4 mm	20
6739000	...673908	1 circular saw blade	∅ 160 mm	∅ 16 mm	2.4 mm	20
6733000	...673304	1 circular saw blade	∅ 160 mm	∅ 20 mm	2.4 mm	20
6644000	...664401	1 circular saw blade	∅ 165 mm	∅ 20, 16 mm	2.4 mm	20
6734000	...673403	1 circular saw blade	∅ 180 mm	∅ 20 mm	2.4 mm	22
6646000	...664609	1 circular saw blade	∅ 184 mm	∅ 20, 16 mm	2.4 mm	22
6735000	...673502	1 circular saw blade	∅ 190 mm	∅ 16 mm	2.4 mm	30
6736000	...673601	1 circular saw blade	∅ 190 mm	∅ 30 mm	2.4 mm	30
6737000	...673700	1 circular saw blade	∅ 210 mm	∅ 30 mm	2.4 mm	30
6650000	...665002	1 circular saw blade	∅ 235 mm	∅ 30 mm	3.2 mm	30

6.6 Saw blades

Blue series - fine cuts



- particularly suitable for cross cuts
- for wood, plywood, profiled boards, panels
- material: CV
- pointed tooth
- quality of cut: fine cuts
- packaging: double card with inlaid blister



article no.	EAN 4006885...	description	Ø	bore	cutting width	teeth
6255000	...625501	1 circular saw blade	Ø 127 mm	Ø 12.75 mm	2 mm	80
6256000	...625600	1 circular saw blade	Ø 130 mm	Ø 16 mm	2 mm	80
6258000	...625808	1 circular saw blade	Ø 140 mm	Ø 12.75 mm	2 mm	100
6259000	...625907	1 circular saw blade	Ø 140 mm	Ø 20 mm	2 mm	100
6263000	...626300	1 circular saw blade	Ø 150 mm	Ø 16 mm	2 mm	100
6264000	...626409	1 circular saw blade	Ø 150 mm	Ø 20 mm	2 mm	100
6267000	...626706	1 circular saw blade	Ø 160 mm	Ø 16 mm	2 mm	100
6268000	...626805	1 circular saw blade	Ø 160 mm	Ø 20 mm	2 mm	100
6272000	...627208	1 circular saw blade	Ø 180 mm	Ø 20 mm	2.4 mm	100
6273000	...627307	1 circular saw blade	Ø 184 mm	Ø 16 mm	2.4 mm	100
6275000	...627505	1 circular saw blade	Ø 190 mm	Ø 16 mm	2.4 mm	100
6276000	...627604	1 circular saw blade	Ø 190 mm	Ø 20 mm	2.4 mm	100
6277000	...627703	1 circular saw blade	Ø 190 mm	Ø 30 mm	2.4 mm	100
6281000	...628106	1 circular saw blade	Ø 210 mm	Ø 30 mm	2.4 mm	100

Cordless circular saw blades

Purple series - fast, medium-coarse cuts



- especially for use on cordless power tools
- length and cross cuts
- for wood, wood with nails, plastic materials, sheet steel, non-ferrous metals
- tear-free cutting edges
- noise insulation by laser slots
- reduced blade thickness for less resistance
- special tooth geometry for fast work progress
- material: TCT
- surface bright polished
- alternate tooth
- quality of cut: fast, medium-coarse cuts
- packaging: double card with inlaid blister

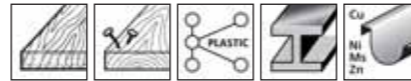

article no.	EAN	description	Ø	bore	cutting width	teeth
6340000	...634008	1 circular saw blade for cordless circular hand saws	Ø 85 mm	Ø 15, 10 mm	1.5 mm	16
6341000	...634107	1 circular saw blade for cordless circular hand saws	Ø 135 mm	Ø 20 mm	1.8 mm	24
6342000	...634206	1 circular saw blade for cordless circular hand saws	Ø 150 mm	Ø 20, 16 mm	1.8 mm	24
6344000	...634404	1 circular saw blade for cordless circular hand saws	Ø 165 mm	Ø 20, 15.87 mm	1.8 mm	24
6343000	...634305	1 circular saw blade for cordless circular hand saws	Ø 165 mm	Ø 16 mm	1.8 mm	24

6.6 Saw blades

Circular table saw blades

Purple series - fine, clean cuts



- multi-purpose saw blade for heavy-duty applications
- length and cross cuts
- for wood, wood with nails, plastic materials, thin steel profiles, non-ferrous metals
- tear-free cutting edges
- noise insulation by laser slots
- material: TCT
- surface bright polished
- trapezoidal tooth/flat tooth
- quality of cut: fine, clean cuts
- packaging: covering box

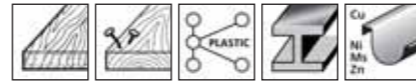

article no.	EAN	description	Ø	bore	cutting width	teeth
6583000	4006885...658301	1 circular saw blade	Ø 250 mm	Ø 30 mm	3.2 mm	42
6584000	...658400	1 circular saw blade	Ø 315 mm	Ø 30 mm	3.2 mm	48

Orange series - fine, clean cuts



- length and cross cuts
- for solid wood, chipboards, plywood, wood core chipboards, fibre boards, profiled boards, panels
- tear-free cutting edges
- material: TCT
- surface bright polished
- shot-blasted tooth rim
- universal alternate tooth
- quality of cut: fine, clean cuts
- packaging: covering box



article no.	EAN	description	Ø	bore	cutting width	teeth
6680000	4006885...668003	1 circular saw blade	Ø 250 mm	Ø 30 mm	3.2 mm	42
6682000	...668201	1 circular saw blade	Ø 300 mm	Ø 30 mm	3.2 mm	48
6684000	...668409	1 circular saw blade	Ø 315 mm	Ø 30 mm	3.2 mm	48
6686000	...668607	1 circular saw blade	Ø 350 mm	Ø 30 mm	3.5 mm	54

POWER TOOL ACCESSORIES

6.6 Saw blades

6

Green series - fast, medium-coarse cuts



- length and cross cuts
- for solid wood, natural woods, chipboards, plywood, timber, firewood
- material: TCT
- surface bright polished
- shot-blasted tooth rim
- alternate tooth for length cuts with chip deflector
- quality of cut: fast, medium-coarse cuts
- packaging: covering box

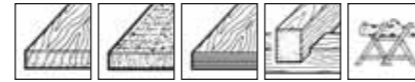

article no.	EAN	description	Ø	bore	cutting width	teeth
6660000	...666009	1 circular saw blade	Ø 250 mm	Ø 30 mm	3.2 mm	24
6662000	...666207	1 circular saw blade	Ø 300 mm	Ø 30 mm	3.2 mm	28
6664000	...666405	1 circular saw blade	Ø 315 mm	Ø 30 mm	3.2 mm	28
6666000	...666603	1 circular saw blade	Ø 350 mm	Ø 30 mm	3.5 mm	32
6668000	...666801	1 circular saw blade	Ø 400 mm	Ø 30 mm	3.5 mm	36

Brown series - fast, rough cuts



- length and cross cuts
- for wood, chipboards
- material: TCT
- surface ground
- shot-blasted tooth rim
- alternate tooth
- quality of cut: fast, rough cuts
- packaging: covering box



article no.	EAN	description	Ø	bore	cutting width	teeth
6740000	...674004	1 circular saw blade	Ø 250 mm	Ø 30 mm	3.2 mm	24
6741000	...674103	1 circular saw blade	Ø 300 mm	Ø 30 mm	3.2 mm	28
6742000	...674202	1 circular saw blade	Ø 315 mm	Ø 30 mm	3.2 mm	28
6593000	...659308	1 circular saw blade	Ø 350 mm	Ø 30 mm	3.2 mm	32
6594000	...659407	1 circular saw blade	Ø 400 mm	Ø 30 mm	3.5 mm	36
6595000	...659506	1 circular saw blade	Ø 450 mm	Ø 30 mm	3.5 mm	40

6.6 Saw blades

Red series - fast, rough cuts



- for hard and soft wood, chipboards, plywood, timber, firewood
- material: CV
- surface brightly polished
- peg tooth
- quality of cut: fast, rough cuts
- packaging: covering box



article no.	EAN 4006885...	description	Ø	bore	cutting width	teeth
6600000	...660007	1 circular saw blade	Ø 250 mm	Ø 30 mm	1.4 mm	56
6602000	...660205	1 circular saw blade	Ø 300 mm	Ø 30 mm	1.6 mm	56
6604000	...660403	1 circular saw blade	Ø 315 mm	Ø 30 mm	1.8 mm	56
6606000	...660601	1 circular saw blade	Ø 350 mm	Ø 30 mm	1.8 mm	56
6608000	...660809	1 circular saw blade	Ø 400 mm	Ø 30 mm	2 mm	56

Cross and mitre cut saw blades

Purple series - fine, clean cuts



- precision cuts
- for wood, wood with nails, plastic materials, thin steel profiles, non-ferrous metals
- diamond ground
- material: TCT
- surface brightly polished
- flat trapezoidal tooth with negative rake
- quality of cut: fine, clean cuts
- packaging: double card

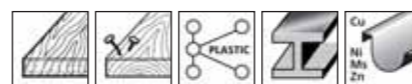

article no.	EAN 4006885...	description	Ø	bore	cutting width	teeth
6540000	...654006	1 circular saw blade	Ø 210 mm	Ø 30 mm	2.8 mm	64
6541000	...654105	1 circular saw blade	Ø 216 mm	Ø 30 mm	2.8 mm	64
6542000	...654204	1 circular saw blade	Ø 250 mm	Ø 30, 20 mm	3.2 mm	80
6543000	...654303	1 circular saw blade	Ø 254 mm	Ø 30 mm	3.2 mm	80
6544000	...654402	1 circular saw blade	Ø 305 mm	Ø 30 mm	3.2 mm	96

POWER TOOL ACCESSORIES

6.6 Saw blades

6

Silver series - cleanest cuts



- for plywood, coated wood and chipboards, single-sided veneered boards, profiled boards, panels
- diamond ground
- noise insulation by laser slots
- material: TCT
- surface brightly polished
- shot-blasted tooth rim, laser and cooling slots
- flat concave tooth (hollow face) with negative rake
- quality of cut: cleanest cuts
- packaging: double card



article no.	EAN 4006885...	description	∅	bore	cutting width	teeth
6521000	...652101	1 circular saw blade	∅ 205 mm	∅ 18 mm	2.2 mm	40
6522000	...652200	1 circular saw blade	∅ 209 mm	∅ 30 mm	2.2 mm	40
6527000	...652705	1 circular saw blade	∅ 250 mm	∅ 30 mm	2.6 mm	48

Orange series - fine, clean cuts



- for solid wood, chipboards, plywood, wood core chipboards, fibre boards, profiled boards, panels
- tear-free cutting edges
- diamond ground
- material: TCT
- surface brightly polished
- alternate tooth with negative rake
- quality of cut: fine, clean cuts
- packaging: double card

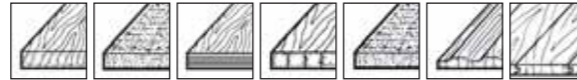

article no.	EAN 4006885...	description	∅	bore	cutting width	teeth
6545000	...654501	1 circular saw blade	∅ 210 mm	∅ 30 mm	2.6 mm	48
6546000	...654600	1 circular saw blade	∅ 216 mm	∅ 30 mm	2.6 mm	48
6547000	...654709	1 circular saw blade	∅ 250 mm	∅ 30, 20 mm	3 mm	48
6548000	...654808	1 circular saw blade	∅ 254 mm	∅ 30 mm	3 mm	48
6549000	...654907	1 circular saw blade	∅ 305 mm	∅ 30 mm	3 mm	72

6.6 Saw blades

Green series - fast, medium-coarse cuts



- for wood, chipboards, single-sided veneered boards, panels
- diamond ground
- material: TCT
- surface brightly polished
- shot-blasted tooth rim
- alternate tooth with negative rake
- quality of cut: fast, medium-coarse cuts
- packaging: double card



article no.	EAN	description	∅	bore	cutting width	teeth
6511000	...651104	1 circular saw blade	∅ 205 mm	∅ 18 mm	2.8 mm	24
6517000	...651708	1 circular saw blade	∅ 250 mm	∅ 30 mm	3.2 mm	24

Brown series - fast, rough cuts



- for wood, chipboards
- diamond ground
- material: TCT
- surface brightly polished
- alternate tooth with negative rake
- quality of cut: fast, rough cuts
- packaging: double card



article no.	EAN	description	∅	bore	cutting width	teeth
6550000	...655003	1 circular saw blade	∅ 210 mm	∅ 30 mm	3.2 mm	24
6551000	...655102	1 circular saw blade	∅ 216 mm	∅ 30 mm	3.2 mm	24
6552000	...655201	1 circular saw blade	∅ 250 mm	∅ 30, 20 mm	3.2 mm	24
6553000	...655300	1 circular saw blade	∅ 254 mm	∅ 30 mm	3.2 mm	24
6554000	...655409	1 circular saw blade	∅ 305 mm	∅ 30 mm	3.2 mm	24

Blue series - fine, easy cuts



- for wood, chipboards, wood core chipboards
- material: CV
- surface brightly polished
- depressed centre with negative rake
- quality of cut: fine cuts
- packaging: double card

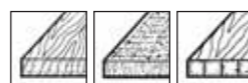

article no.	EAN	description	∅	bore	cutting width	teeth
6501000	...650107	1 circular saw blade	∅ 205 mm	∅ 18 mm	2.6 mm	72
6502000	...650206	1 circular saw blade	∅ 209 mm	∅ 30 mm	2.6 mm	100

POWER TOOL ACCESSORIES 6
6.7 Rasps / Countersinks



6.7 Rasps / Countersinks

Countersinks



- for countersink screws \varnothing 3 - 8 mm
- for wood, plastic materials
- material: tool steel
- packaging: blister on card

article no.	EAN	description	\varnothing	angle	shank
2504000	4006885... ...250406	3 countersinks	\varnothing 6, 12, 16 mm	45°	\varnothing 6 mm



- for metals, non-ferrous metals, plastic materials, wood
- material: HSS
- version: 3 cutting edges
- packaging: blister on card

article no.	EAN	description	\varnothing	angle	shank
2505000	4006885... ...250505	1 countersink	\varnothing 12 mm	45°	\varnothing 8 mm
2506000	...250604	1 countersink	\varnothing 16 mm	45°	\varnothing 8 mm



- for metal, non-ferrous metals, plastic materials, wood
- for deburring and countersinking bores in metal
- adjustable depth stop for constant countersinks up to \varnothing 16.5 mm
- material: HSS
- version: 3 cutting edges
- packaging: blister on card



article no.	EAN	description	\varnothing	angle	length	shank
4391000	4006885... ...439108	1 countersink with depth stop	\varnothing 16.5 mm	45°	60 mm	triangular shank

POWER TOOL ACCESSORIES 6

6.7 Rasps / Countersinks



- for wood, plastic materials
- drills and sinks in one workstep
- avoids the unintentional ripping of wood
- 1/4" hexagonal shank for quick tool changes in bit holders
- material: tool steel
- version: 3 cutting edges
- packaging: blister on card



article no.	EAN 4006885...	description	∅	angle	for
2546000	...254602	1 countersink	∅ 3 - 8 mm	45°	for countersink screws ∅ 3,5 - 4 mm
2547000	...254701	1 countersink	∅ 4 - 10 mm	45°	for countersink screws ∅ 4,5 - 5 mm
2548000	...254800	1 countersink	∅ 5 - 12 mm	45°	for countersink screws ∅ 5,5 - 6 mm



For drilling and countersinking

- for metal, non-ferrous metals, plastic material, fibre glass reinforced plastic
- 2-in-1 product: screw starter and countersink
- limit stop for controlled drilling, prevents inadvertent break-through and damage to the substructure
- 1/4" hexagonal shank for quick tool changes in bit holders
- material: HSS
- version: 3 cutting edges
- packaging: blister on card

article no.	EAN 4006885...	description	∅	angle	miscellaneous
4382000	...438200	1 countersink with limit stop	∅ 10 mm	45°	up to 10 mm material thickness
4383000	...438309	1 countersink with limit stop	∅ 12 mm	45°	up to 12 mm material thickness

6 POWER TOOL ACCESSORIES

6.7 Rasps / Countersinks



- for wood, plastic materials
- 1/4" hexagonal shank for quick tool changes in bit holders
- material: tool steel
- version: 1 cutting edge
- packaging: blister on card

article no.	EAN 4006885...	description	∅	angle	for
2582000	...258204	1 countersink	∅ 10 mm	45°	for countersink screws ∅ 3 - 5 mm
2576000	...257603	1 countersink	∅ 12 mm	45°	for countersink screws ∅ 3 - 6 mm
2577000	...257702	1 countersink	∅ 16 mm	45°	for countersink screws ∅ 3 - 8 mm
2578000	...257801	1 countersink	∅ 19 mm	45°	for countersink screws ∅ 3 - 10 mm
2584000	...258402	3 countersinks	∅ 12, 16, 19 mm	45°	for countersink screws ∅ 3 - 10 mm



- for wood
- precise countersinking for flush screws in wood
- adjustable depth stop with fixed setting positions for countersink screws with thread diameter up to 10 mm
- 1/4" hexagonal shank for quick tool changes in bit holders
- material: WS
- version: 3 cutting edges
- packaging: blister on card

article no.	EAN 4006885...	description	∅	angle
4390000	...439009	1 countersink with depth stop	∅ 20 mm	45°

POWER TOOL ACCESSORIES

6.7 Rasps / Countersinks

6



- for metal, non-ferrous metals, plastic materials, wood
- 1/4" hexagonal shank for quick tool changes in bit holders
- material: HSS
- version: 3 cutting edges
- packaging: blister on card



article no.	EAN 4006885...	description	∅	angle
2583000	...258303	1 countersink	∅ 10 mm	45°
2580000	...258006	1 countersink	∅ 12 mm	45°
2581000	...258105	1 countersink	∅ 16 mm	45°



- machine: cordless screwdrivers
- for wood, plastic materials
- ideally suited for counterboring prior to flush fastening
- deep countersinking possible - the screw head can be placed underneath the surface
- cross hole with groove for optimum chip removal while working
- 1/4" hexagonal shank (E6.3) for quick tool changes in bit holders
- material: tool steel
- version: 1 cutting edge
- packaging: blister on card



article no.	EAN 4006885...	description	∅	angle	length	for
4370000	...437005	1 deburring counter	∅ 8 mm	45°	38 mm	for countersink screws ∅ 3 - 4 mm
4371000	...437104	1 deburring counter	∅ 10 mm	45°	39 mm	for countersink screws ∅ 3 - 5 mm
4372000	...437203	1 deburring counter	∅ 12 mm	45°	41 mm	for countersink screws ∅ 3 - 6 mm
4373000	...437302	1 deburring counter	∅ 16 mm	45°	46 mm	for countersink screws ∅ 3 - 8 mm
4374000	...437401	1 deburring counter	∅ 20 mm	45°	48 mm	for countersink screws ∅ 3 - 10 mm
4375000	...437500	3 deburring counters	∅ 8, 12, 16 mm	45°		for countersink screws ∅ 3 - 8 mm

6.7 Rasps / Countersinks

Hand countersinks



- for wood, aluminium profiles, plastic materials
- material: plastic and WS
- version: 3 cutting edges
- packaging: blister on card

article no.	EAN	description	∅	angle
4315000	...431508	1 hand countersink	∅ 19 mm	45°

Screw starters with countersink



- for wood
- drills and sinks in one workstep
- version: with countersink
- packaging: blister on card

article no.	EAN	description	∅	angle	drill	for
2498000	...249806	1 screw starters with countersink	∅ 3.2 - 12 mm	45°	∅ 3.2 mm	for countersink screws ∅ 3,5 - 6 mm
2500000	...250000	1 screw starters with countersink	∅ 3.5 - 9.5 mm	45°	∅ 3.5 mm	for countersink screws ∅ 4 - 4,5 mm
2511000	...251106	1 screw starters with countersink	∅ 4.5 - 11 mm	45°	∅ 4.5 mm	for countersink screws ∅ 5 - 6 mm
2499000	...249905	1 screw starters with countersink	∅ 4.5 - 16 mm	45°	∅ 4.5 mm	for countersink screws ∅ 5 - 8 mm



- especially for drilling in terrace wood
- for wood
- drills and sinks in one workstep
- 1/4" hexagonal shank for quick tool changes in bit holders
- version: with countersink
- packaging: blister on card

article no.	EAN	description	∅	angle	for
2545000	...254503	1 screw starters with countersink	∅ 4.5 - 12 mm	45°	for countersink screws ∅ 5 - 6 mm

POWER TOOL ACCESSORIES 6

6.7 Rasps / Countersinks



- for wood
- 1/4" hexagonal shank for quick tool changes in bit holders
- drills and sinks in one workstep
- thanks to the adjustable depth stop perfect for series drilling; always the same depth
- version: with countersink, with adjustable depth stop
- packaging: blister on card



article no.	EAN	description	∅	angle	for
2544000	...254404	1 screw starter	∅ 3.2 - 12 mm	45°	for countersink screws ∅ 3,5 - 6 mm



- for wood
- 1/4" hexagonal shank for quick tool changes in bit holders
- drills and sinks in one workstep
- thanks to the adjustable depth stop perfect for series drilling; always the same depth
- version: with countersink, with adjustable depth stop
- packaging: blister on card



article no.	EAN	description	∅	angle	for
4392000	...439207	1 screw starter	∅ 3.2 - 12 mm	45°	for countersink screws ∅ 3,5 - 6 mm

Assortments



- for wood, plastic material
- shank: hexagon shank
- content:
 - 1 bit holder, with magnet
 - 3 countersinks, ∅ 8, 10, 12 mm
 - 3 bits, Pozidriv PZ 1 - 2 - 3
 - 3 bits, Torx TX 15 - 20 - 30
- packaging: blister on card

article no.	EAN	description	for
2542000	...254206	1 screwing set	for countersink screws ∅ 3,5 - 6 mm

6 POWER TOOL ACCESSORIES

6.7 Rasps / Countersinks

Rotary rasps



- for preparing recesses and the quick removal of material
- for wood
- material: tool steel
- packaging: blister on card

article no.	EAN 4006885...	description	Ø	working length	form	shank
2530000	...253001	1 rotary rasp	Ø 13.5 mm	35 mm	cylindrical	Ø 6.35 mm
2531000	...253100	1 rotary rasp	Ø 13.5 mm	35 mm	cylindrically curved	Ø 6.35 mm
2532000	...253209	1 rotary rasp	Ø 5 - 13.5 mm	35 mm	conical	Ø 6.35 mm
2533000	...253308	1 rotary rasp	Ø 15 mm	12.5 mm	spherical	Ø 6.35 mm
2536000	...253605	1 rotary rasp	Ø 14 mm	30 mm	pear-shaped	Ø 6.35 mm



- machine: cordless screwdrivers
- for preparing recesses and the quick removal of material
- for wood
- 1/4" hexagonal shank (E6.3) for quick tool changes in bit holders
- material: tool steel
- packaging: blister on card

article no.	EAN 4006885...	description	Ø	working length	form	length
2527000	...252707	1 rotary rasp	Ø 13.5 mm	35 mm	cylindrical	
4376000	...437609	1 rotary rasp	Ø 13 mm	22 mm	cylindrical	48 mm
4377000	...437708	1 rotary rasp	Ø 13 mm	22 mm	pear-shaped	48 mm
4378000	...437807	1 rotary rasp	Ø 6 - 12 mm	22 mm	conical	48 mm
4379000	...437906	1 rotary rasp	Ø 15 mm		spherical	41 mm



- for sheet steel, aluminium, non-ferrous metals
- material: tool steel
- packaging: blister on card

article no.	EAN 4006885...	description	Ø	working length	form	shank
2534000	...253407	1 rotary rasp	Ø 12.5 mm	35 mm	cylindrical	Ø 6.35 mm
2535000	...253506	1 rotary rasp	Ø 5 - 12 mm	35 mm	conical	Ø 6.35 mm

POWER TOOL ACCESSORIES 6

6.7 Rasps / Countersinks



- machine: cordless screwdrivers
- for sheet steel, aluminium, non-ferrous metals
- 1/4" hexagonal shank (E6.3) for quick tool changes in bit holders
- material: tool steel
- packaging: blister on card



article no.	EAN	description	∅	working length	form	length
4380000	...438007	1 rotary rasp	∅ 12 mm	22 mm	cylindrical	48 mm
4381000	...438101	1 rotary rasp	∅ 6 - 11 mm	22 mm	conical	48 mm

Assortments



- for preparing recesses and the quick removal of material
- material: tool steel
- content:
 - 1 rotary rasp, cylindrical, ∅ 13,5 mm, wood
 - 1 rotary rasp, conical, ∅ 5 - 12 mm, wood
 - 1 rotary rasp, spherical, ∅ 15 mm, wood
 - 1 rotary rasp, cylindrical, ∅ 12,5 mm, metal
 - 1 countersink, ∅ 12 mm, wood
- packaging: blister on card



article no.	EAN	description	shank
2540000	...254008	1 rasp and countersink set	∅ 6.35 mm

6.7 Rasps / Countersinks

Drum rasps



- for wood, aluminium
- no glazing
- no re-sharpening required
- material: tool steel
- packaging: blister on card

article no.	EAN	description	∅	working length	shank
2520000	4006885... ...252004	1 drum rasp	∅ 52 mm	30 mm	∅ 6 mm



- for wood, aluminium, sheet steel
- content:
 - 1 roughing rasp, ∅ 52 mm
 - 1 smooth polishing rasp, ∅ 52 mm
 - 1 sanding belt, ∅ 45 mm, coarse
 - 1 sanding belt, ∅ 45 mm, fine
- packaging: blister on card
- separate accessories: 2039000

article no.	EAN	description	shank
2521000	4006885... ...252103	1 drum rasp set	∅ 6 mm

Enlarging mills



- for wood, plastic materials, non-ferrous metals
- material: WS
- packaging: blister on card

article no.	EAN	description	∅	working length	shank
2523000	4006885... ...252301	1 enlarging mill	∅ 6 - 24 mm	32 mm	∅ 8 mm

POWER TOOL ACCESSORIES

6.7 Rasps / Countersinks

6



- for plastic materials, non-ferrous metals, sheet steel, stainless steel
- material: HSS
- version: 2 cutting edges
- packaging: blister on card

article no.	EAN	description	∅	working length	shank
2518000	4006885...251809	1 enlarging mill	∅ 3 - 13.5 mm	30 mm	∅ 8 mm
2524000	...252400	1 enlarging mill	∅ 5 - 20 mm	42.5 mm	∅ 8 mm
2519000	...251908	1 enlarging mill	∅ 8 - 31 mm	52.5 mm	∅ 10 mm



- for plastic materials, non-ferrous metals, sheet steel, stainless steel
- material: HSS
- packaging: blister on card

article no.	EAN	description	∅	working length	shank
2522000	4006885...252202	1 enlarging mill	∅ 6 - 25 mm	32 mm	∅ 8 mm



- for plastic materials, non-ferrous metals, sheet steel, stainless steel
- with drilling tip for marking or starting
- hexagonal shank, for the quick change of tools in bit holders
- material: HSS
- version: 2 cutting edges
- packaging: blister on card

article no.	EAN	description	∅	working length
4393000	4006885...439306	1 enlarging mill	∅ 4 - 12.2 mm	21 mm

6.7 Rasps / Countersinks

Step drills



- for stainless steel, sheet steel, non-ferrous metals, plastic materials
- material: HSS
- version: with drilling tip, 3 cutting edges
- packaging: blister on card

article no.	EAN 4006885...	description	gradual diameter	working length	shank
2515000	...251502	1 step drill	ø 4 - 6 - 8 - 10 - 12 - 14 - 16 - 18 - 20 mm	42.5 mm	ø 8 mm
2516000	...251601	1 step drill	ø 8 - 14 - 16 - 18 - 20 - 22 - 24 - 26 - 28 - 30 mm	52.5 mm	ø 10 mm
2585000	...258501	1 step drill	ø 8 - 14 - 16 - 18 - 20 - 22 - 26 - 28 - 32 - 35 mm	52.5 mm	ø 10 mm



- especially for metal screws
- for stainless steel, metals, non-ferrous metals, sheet steel, plastic material
- 1/4" hexagonal shank for quick tool changes in bit holders
- material: HSS
- version: 3 cutting edges
- packaging: blister on card

article no.	EAN 4006885...	description	gradual diameter	working length
2555000	...255500	1 step drill	ø 6 - 8 - 10 mm	21 mm



6.8 Drill chucks

Quick-release drill chucks



- machine: cordless screwdrivers and power drills
- series "Economy line"
- right/left rotation
- packaging: blister on card

article no.	EAN	description	clamping width	drill chuck receptacle	thread
2641000	4006885...264106	1 quick-release chuck "Economy line"	1.5 - 10 mm	10 (3/8") - 24	female thread
2642000	4006885...264205	1 quick-release chuck "Economy line"	1.5 - 13 mm	13 (1/2") - 20	female thread



- machine: power drills and hammer drills
- for quickly clamping and releasing tools
- with clamping pressure lock
- version: impact-resistant
- right/left rotation
- packaging: double blister

article no.	EAN	description	clamping width	drill chuck receptacle	thread
2606000	4006885...260603	1 quick-release chuck	1.5 - 13 mm	13 (1/2") - 20	female thread



- machine: cordless screwdrivers and power drills
- version: impact-resistant
- right/left rotation
- packaging: double blister

article no.	EAN	description	clamping width	drill chuck receptacle	thread
2618000	4006885...261808	1 quick-release chuck	1.5 - 13 mm	13 (1/2") - 20	female thread



- machine: cordless screwdrivers and power drills
- for quickly clamping and releasing tools
- with radial lock
- version: impact-resistant
- right/left rotation
- packaging: double blister

article no.	EAN	description	clamping width	drill chuck receptacle	thread
2623000	4006885...262300	1 quick-release chuck	1.5 - 13 mm	10 (3/8") - 24	female thread

POWER TOOL ACCESSORIES

6.8 Drill chucks

6



- machine: screwdrivers with hexagon receptacle
- clockwise rotation
- packaging: double blister

article no.	EAN	description	shank	clamping width
2625000	4006885... ...262508	1 quick-release chuck	hexagon shank	0.5 - 6.5 mm

Key-type drill chucks



- machine: power drills
- version: impact-resistant
- right/left rotation
- packaging: double blister
- separate accessories: 2630000, 2635000

article no.	EAN	description	clamping width	drill chuck receptacle	thread
2603000	4006885... ...260306	1 key-type drill chuck	1.5 - 13 mm	13 (1/2") - 20	female thread



- machine: power drills
- series "Economy line"
- version: impact-resistant
- right/left rotation
- packaging: blister on card
- separate accessories: 2630000, 2635000

article no.	EAN	description	clamping width	drill chuck receptacle	thread
2645000	4006885... ...264502	1 key-type drill chuck "Economy line"	1.5 - 13 mm	13 (1/2") - 20	female thread

Accessories



- according to DIN 6349
- packaging: blister on card

article no.	EAN	description	key description	suitable for	suitable for
2630000	4006885... ...263000	1 chuck key	S2A	AEG, Bosch, Fein, Kress, Metabo, Rockwell, Röhm, Skil, Wolf, wolcraft	2603000, 2645000
2631000	...263109	1 chuck key	B16, S3	wolcraft	
2632000	...263208	1 chuck key	Jacobs K6, S14	Black & Decker, Makita, Metabo, Skil, Wolf	

6 POWER TOOL ACCESSORIES

6.8 Drill chucks



- for all common drill chucks
- chuck key sizes in 4 - 5,5 - 6 - 7 mm
- packaging: fixed on card

article no.	EAN	description	suitable for
2635000	4006885... ...263505	1 universal chuck key	2603000, 2645000



- machine: hammer drills with SDS-plus holder
- for drill chucks with 13 (1/2") x 20 mm female thread
- only for rotary use - not impact-resistant
- packaging: blister on card

article no.	EAN	description	shank
2640000	4006885... ...264007	1 drill chuck adapter	SDS-plus

Assortments



- machine: hammer drills with SDS-plus holder
- series "Economy line"
- only for rotary use - not impact-resistant
- content:
 - 1 drill chuck, 1.5 - 13 mm, female thread 13 (1/2") x 20 mm
 - 1 chuck key, S2A
 - 1 drill chuck adapter, SDS-plus, with 13 (1/2") x 20 mm thread
- packaging: double blister

article no.	EAN	description	shank
2649000	4006885... ...264908	1 SDS-plus set "Economy line"	SDS-plus

Flexible shafts



- machine: power drills
- with anti-kink device
- clockwise rotation
- max. 3,500 RPM
- including:
 - 1 key-type drill chuck, 8 mm
 - 1 chuck key
- packaging: fixed on card

article no.	EAN	description	shank	clamping width	version	length
2147000	4006885... ...214705	1 flexible shaft	ø 8 mm	1.5 - 8 mm	3 ball bearings heavy-duty version	1,300 mm

POWER TOOL ACCESSORIES 6

6.8 Drill chucks



- machine: power drills
- with anti-kink device
- clockwise rotation
- max. 3,500 RPM
- including: 1 quick-release chuck, 6 mm
- packaging: fixed on card

article no.	EAN	description	shank	clamping width	version	length
2230000	4006885... ...223004	1 flexible shaft	ø 6 mm	0.5 - 6 mm	2 ball bearings	1,300 mm

6.9 Router bits



POWER TOOL ACCESSORIES 6

6.9 Router bits

Routers

For precise milling work using the router and stationary milling motor.

TCT router bits

TCT-Milling cutters with hard-metal cutting edges are particularly suitable for milling of hard wood, chipboard, hard fibre board and plastic-coated boards.



- machine: routers
- material: TCT
- in plastic box
- packaging: sticker

article no.	EAN 4006885...	description	Ø	cutting height	shank
3924000	...392403	1 straight bit	Ø 6 mm	16 mm	Ø 8 mm
3925000	...392502	1 straight bit	Ø 8 mm	16 mm	Ø 8 mm
3926000	...392601	1 straight bit	Ø 10 mm	20 mm	Ø 8 mm
3927000	...392700	1 straight bit	Ø 12 mm	20 mm	Ø 8 mm
3922000	...392205	1 straight bit	Ø 14 mm	20 mm	Ø 8 mm



- machine: routers
- material: TCT
- without shank
- in plastic box
- packaging: sticker
- separate accessories: 3831000, 3931000

article no.	EAN 4006885...	description	Ø	cutting height
3828000	...382800	1 disc groove cutter	Ø 40 mm	3 mm
3829000	...382909	1 disc groove cutter	Ø 40 mm	4 mm



- machine: routers
- in plastic box
- packaging: sticker
- suitable for 3828000, 3829000

article no.	EAN 4006885...	description	shank
3831000	...383104	1 shank	Ø 6 mm
3931000	...393103	1 shank	Ø 8 mm

6 POWER TOOL ACCESSORIES

6.9 Router bits



- machine: routers
- material: TCT
- in plastic box
- packaging: sticker

article no.	EAN	description	∅	cutting height	radius	shank
3967000	4006885... ...396708	1 core box bit	∅ 12.7 mm	9.5 mm	r 6.35 mm	∅ 8 mm



- machine: routers
- material: TCT
- version: with guiding pin carried in ball bearings
- in plastic box
- packaging: sticker

article no.	EAN	description	∅	cutting height	radius	shank
3971000	4006885... ...397101	1 semi core box bit	∅ 22.2 mm	12.7 mm	r 6.35 mm	∅ 8 mm



- machine: routers
- material: TCT
- version: with guiding pin carried in ball bearings
- in plastic box
- packaging: sticker

article no.	EAN	description	∅	cutting height	radius	shank
3863000	4006885... ...386303	1 round over bit	∅ 25.4 mm	12.7 mm	r 6.35 mm	∅ 6 mm
3963000	...396302	1 round over bit	∅ 25.4 mm	12.7 mm	r 6.35 mm	∅ 8 mm

POWER TOOL ACCESSORIES 6

6.9 Router bits

Assortments



- machine: routers
- to create grooves
- universal use through the extended shank, both for freehand-milling and for stationary use
- material: TCT
- shank length 40 mm
- max. 22,000 RPM
- in 2-component plastic box with lid

article no.	EAN	description	content	∅	cutting height	angle	radius	shank
8753000	4006885... ...875302	1 straight bit set	1 V-groove cutter 1 core box bit 1 straight bit 1 straight bit 1 straight bit	∅ 12.5 mm ∅ 12.5 mm ∅ 5 mm ∅ 10 mm ∅ 20 mm	10.5 mm 9.5 mm 20 mm 20 mm 20 mm	45°	r 6.25 r 6.25	∅ 8 mm



- machine: routers
- for creating round profiles
- profile cutter carried in ball bearings
- universal use through the extended shank, both for freehand-milling and for stationary use
- material: TCT
- shank length 40 mm
- max. 22,000 RPM
- in 2-component plastic box with lid

article no.	EAN	description	content	∅	cutting height	angle	radius	shank
8754000	4006885... ...875401	1 profile cutter set	1 semi core box bit 1 chamfering cutter 1 round over bit 1 round over bit 1 S-profile bit	∅ 22 mm ∅ 31 mm ∅ 25 mm ∅ 31 mm ∅ 38 mm	9.5 mm 12.5 mm 11 mm 16 mm 19 mm	45°	r 6.5 r 6.5 r 6.5 r 9.5 r 6.5	∅ 8 mm

6.9 Router bits

HSS router bits

HSS router bits made from high-performance high-speed steel for milling hardwood, softwood and plastic.



- machine: routers
- material: HSS
- in plastic box
- packaging: sticker

article no.	EAN 4006885...	description	Ø	cutting height	shank
3800000	...380004	1 straight bit	Ø 4 mm	13 mm	Ø 6 mm
3801000	...380103	1 straight bit	Ø 5 mm	14 mm	Ø 6 mm
3802000	...380202	1 straight bit	Ø 6 mm	16 mm	Ø 6 mm
3803000	...380301	1 straight bit	Ø 8 mm	20 mm	Ø 6 mm
3804000	...380400	1 straight bit	Ø 10 mm	20 mm	Ø 6 mm
3900000	...390003	1 straight bit	Ø 4 mm	13 mm	Ø 8 mm
3901000	...390102	1 straight bit	Ø 5 mm	14 mm	Ø 8 mm
3902000	...390201	1 straight bit	Ø 6 mm	16 mm	Ø 8 mm
3903000	...390300	1 straight bit	Ø 8 mm	20 mm	Ø 8 mm
3904000	...390409	1 straight bit	Ø 10 mm	20 mm	Ø 8 mm

Power drills

WS routers made from tool steel for milling hardwood and softwood.



- machine: power drills
- material: WS
- packaging: blister on card

article no.	EAN 4006885...	description	Ø	cutting height	shank
3235000	...323506	1 straight bit	Ø 5 mm	15 mm	Ø 8 mm
3236000	...323605	1 straight bit	Ø 8 mm	15 mm	Ø 8 mm
3237000	...323704	1 straight bit	Ø 10 mm	15 mm	Ø 8 mm

POWER TOOL ACCESSORIES

6.9 Router bits

6



- machine: power drills
- material: WS
- packaging: blister on card
- suitable for 3001000

article no.	EAN	description	Ø	cutting height	shank
3264000	4006885...326408	1 slotting cutter	Ø 30 mm	1.5 mm	Ø 8 mm
3263000	4006885...326309	1 slotting cutter	Ø 35 mm	2.5 mm	Ø 8 mm



- machine: power drills
- material: WS
- packaging: blister on card
- suitable for 3001000

article no.	EAN	description	Ø	cutting height	radius	shank
3258000	4006885...325807	1 round over bit	Ø 25 mm	22 mm	r 25 mm	Ø 8 mm



- machine: power drills
- material: WS
- packaging: blister on card
- suitable for 3001000

article no.	EAN	description	Ø	cutting height	shank
3260000	4006885...326002	1 cylindrical cutter	Ø 25 mm	22 mm	Ø 8 mm



- machine: power drills
- material: WS
- packaging: blister on card
- suitable for 3001000

article no.	EAN	description	Ø	cutting height	tongue height	shank
3259000	4006885...325906	1 tongue cutter	Ø 30 mm	22 mm	5 mm	Ø 8 mm

6 POWER TOOL ACCESSORIES

6.9 Router bits



- machine: power drills
- material: WS
- packaging: blister on card
- suitable for 3001000

article no.	EAN	description	∅	cutting height	shank
3261000	4006885... ...326101	1 disc groove cutter	∅ 35 mm	5 mm	∅ 8 mm



- machine: power drills
- material: WS
- packaging: blister on card
- suitable for 3001000

article no.	EAN	description	∅	cutting height	radius	shank
3266000	4006885... ...326606	1 rounding-off cutter	∅ 35 mm	11 mm	r 10 mm	∅ 8 mm



- machine: power drills
- material: WS
- packaging: blister on card
- suitable for 3001000

article no.	EAN	description	∅	cutting height	radius	shank
3267000	4006885... ...326705	1 semi core box bit	∅ 35 mm	11 mm	r 10 mm	∅ 8 mm



- machine: power drills
- material: WS
- packaging: blister on card

article no.	EAN	description	∅	cutting height	shank
3270000	4006885... ...327009	1 slotting saw	∅ 45 mm	1.5 mm	∅ 8 mm

POWER TOOL ACCESSORIES

6

6.9 Router bits



- machine: power drills
- material: WS
- packaging: blister on card

article no.	EAN	description	content	Ø	cutting height
3253000	4006885... ...325302	1 universal bit set	1 slotting cutter	Ø 30 mm	1.5 mm
			1 slotting cutter	Ø 35 mm	2.5 mm
			1 slotting saw	Ø 45 mm	1.5 mm
			1 shank	Ø 8 mm	

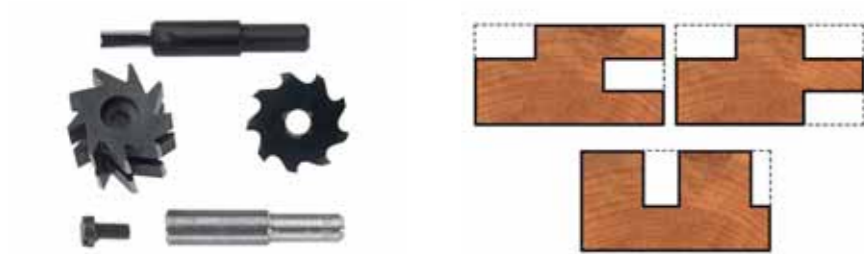

- machine: power drills
- material: WS
- packaging: blister on card

article no.	EAN	description	content	Ø	cutting height
3254000	4006885... ...325401	1 universal bit set	1 tongue cutter	Ø 30 mm	22 mm
			1 disc groove cutter	Ø 35 mm	5 mm
			1 straight bit	Ø 6 mm	
			1 shank	Ø 8 mm	

6.10 Mixers



POWER TOOL ACCESSORIES 6

6.10 Mixers

Paint mixers



- for paint, varnish, glazes
- packaging: bulk



article no.	EAN	description	Ø	length	shank	mixing quantity	machine	rpm
1700099	4006885... ...170094	1 paint mixer	Ø 60 mm	350 mm	Ø 6 mm	-5 kg	min. 400 W	min. 800 - max. 1,000 RPM



- for paint, varnish, glazes
- sturdy design
- well balanced
- smooth running
- packaging: fixed on card



article no.	EAN	description	Ø	length	shank	mixing quantity	machine	rpm
2141000	4006885... ...214101	1 paint mixer	Ø 60 mm	350 mm	Ø 6 mm	-5 kg	min. 400 W	min. 800 - max. 1,000 RPM

Paint and mortar mixers



- for paint, mortar, varnish, glazes
- packaging: bulk



article no.	EAN	description	Ø	length	shank	mixing quantity	machine	rpm
1704099	4006885... ...170490	1 paint and mortar mixer	Ø 60 mm	400 mm	Ø 8 mm	6 - 12 kg	min. 400 W	min. 500 - max. 800 RPM
1705099	...170599	1 paint and mortar mixer	Ø 80 mm	400 mm	Ø 8 mm	5 - 10 kg	min. 400 W	min. 500 - max. 800 RPM
1706099	...170698	1 paint and mortar mixer	Ø 100 mm	590 mm	Ø 10 mm	10 - 20 kg	min. 500 W	min. 500 - max. 600 RPM

6 POWER TOOL ACCESSORIES

6.10 Mixers



- for paint, mortar, varnish, glazes
- sturdy design
- well balanced
- smooth running
- packaging: fixed on card



article no.	EAN 4006885...	description	Ø	length	shank	mixing quantity	machine	rpm
1705000	...170506	1 paint and mortar mixer	Ø 80 mm	400 mm	Ø 8 mm	5 - 10 kg	min. 400 W	min. 500 - max. 800 RPM
1706000	...170605	1 paint and mortar mixer	Ø 100 mm	590 mm	Ø 10 mm	10 - 20 kg	min. 500 W	min. 500 - max. 600 RPM
1707000	...170704	1 paint and mortar mixer	Ø 120 mm	590 mm	Ø 10 mm	20 - 30 kg	min. 700 W	min. 400 - max. 500 RPM

Heavy-duty and adhesive mixers



- for mortar, adhesive
- sturdy design
- well balanced
- smooth running
- packaging: fixed on card



article no.	EAN 4006885...	description	Ø	length	shank	mixing quantity	machine	rpm
1708000	...170803	1 heavy-duty and adhesive mixer	Ø 85 mm	400 mm	Ø 8 mm	5 - 10 kg	min. 400 W	min. 700 - max. 900 RPM

POWER TOOL ACCESSORIES 6

6.10 Mixers



- for mortar, adhesive, filler material, floor screed, plaster
- sturdy design
- well balanced
- smooth running
- packaging: fixed on card



article no.	EAN 4006885...	description	Ø	length	shank	mixing quantity	machine	rpm
1702000	...170209	1 heavy-duty and adhesive mixer "Professional"	Ø 90 mm	400 mm	Ø 8 mm	7 - 10 kg	min. 400 W	min. 400 - max. 500 RPM
1703000	...170308	1 heavy-duty and adhesive mixer "Professional"	Ø 100 mm	590 mm	Ø 10 mm	10 - 15 kg	min. 700 W	min. 400 - max. 500 RPM



- machine: hand mixers
- for mortar, adhesive
- sturdy design
- thread M 14
- packaging: fixed on card



article no.	EAN 4006885...	description	Ø	length	mixing quantity	machine	rpm
1710000	...171008	1 heavy-duty and adhesive mixer	Ø 133 mm	600 mm	15 - 35 kg	min. 900 W	min. 300 - max. 700 RPM

6.11 Attachments



POWER TOOL ACCESSORIES 6

6.11 Attachments

Drill stands

1 drill stand



depth adjustment by means of a depth stop with quick adjuster



cable routing



- for drilling flat surfaces, round work pieces and battens with precision
- milled worktop with clamping grooves for fastening clamping blocks or vices
- sturdy 40 mm round column with a 340 mm long toothed rack screwed on - no twisting while drilling
- integrated return spring
- locking button for series drilling
- adjustable scale ring for setting the accurate drilling depth down to the last millimeter
- with cable holder
- working height 305 mm
- Euronorm collar \varnothing 43 mm
- strong cast iron plate 203 x 307 mm
- packaging: covering box

article no.	EAN	description	depth	product dimensions
5027000	4006885... ...502703	1 drill stand	130 mm	203 x 307 x 570 mm

6 POWER TOOL ACCESSORIES

6.11 Attachments



depth of cut set by depth stop

- for drilling flat surfaces, round work pieces and battens with precision
- milled worktop with clamping grooves for fastening clamping blocks or vices
- integrated return spring
- with round column
- working height 345 mm
- Euronorm collar \varnothing 43 mm
- cast iron plate 160 x 230 mm
- packaging: covering box



article no.	EAN	description	depth	product dimensions
3406000	4006885... ...340602	1 drill stand	112 mm	160 x 230 x 500 mm

Vices



- with quick adjuster
- steel jaw with horizontal V-grooves to clamp round materials
- trapezoidal steel spindle
- material: grey cast iron
- packaging: paperboard card

article no.	EAN	description	clamping width	jaw width
3423000	4006885... ...342309	1 machine vice	80 mm	85 mm

POWER TOOL ACCESSORIES

6

6.11 Attachments



4920000



3410000

- for drill stands and workbenches
- with quick adjuster
- jaw with horizontal and vertical V-grooves to clamp round materials
- material: die-cast aluminium
- packaging: paperboard card

article no.	EAN	description	clamping width	jaw width
4920000	4006885... ...492004	1 quick-action vice	60 mm	70 mm
3410000	...341005	1 quick-action vice	100 mm	100 mm



- jaw with horizontal and vertical V-grooves to clamp round materials
- material: die-cast aluminium
- packaging: bulk

article no.	EAN	description	clamping width	jaw width
3412099	4006885... ...341296	1 Simplex 60 - vice	65 mm	68 mm

6.11 Attachments

Drill guides

Freehand drilling, just like the professionals!

1 tecmobil - mobile drill stand



with connector for dust extraction - dustfree drilling in every position



tiltable double guide bars with scale for drilling +/- 45°



grab handle for precise placement and against skidding when drilling



integrated V-groove for securely fixing round workpieces



The ideal accessory for your power drill, for precision drilling and hole sawing at given angles in any situation - on the wall, overhead, on slants, in round workpieces, battens and shaped sections.

- machine: power drills
- with connector for dust extraction - dustfree drilling in every position
- tiltable double guide bars with scale for drilling +/- 45°
- infinitely adjustable depth stop
- straight guide for drilling a number of holes in a line
- grab handle for precise placement and against skidding when drilling
- the mobile drill stand can also be used as a stationary drill thanks to the four holes in the base plate
- integrated V-groove for securely fixing round workpieces
- base plate with centring mechanism allows centered drilling
- no more searching for drills - drill stack inside handle
- rubber buffers for stable hold on smooth surfaces
- Euronorm collar ø 43 mm
- packaging: covering box

article no.	EAN	description	product dimensions
4522000	4006885... ...452206	1 tecmobil - mobile drill stand	265 x 150 x 295 mm

POWER TOOL ACCESSORIES 6

6.11 Attachments



- machine: power drills
- handy drilling aid
- rapid assembling system without tools
- handle and rubber buffers for fixing the appliance safely prevents the drill from running off
- positioning lines and an inspection hole will pinpoint the borehole
- integrated dust collection bag
- Euronorm collar \varnothing 43 mm
- packaging: fixed on card

article no.	EAN	description	product dimensions
4521000	4006885... ...452107	1 tecmobil 200 - mobile drilling aid	240 x 85 x 270 mm



- machine: cordless screwdrivers and power drills
- for drilling rectangular holes in a speedy and simple way - also for the less experienced craftsman
- rubber buffers prevent the drill from running off on smooth surfaces
- positioning lines for drilling precise boreholes
- integrated V-groove for securely fixing round workpieces
- 5 metal drill guide bushes for drills \varnothing 4, 5, 6, 8, 10 mm
- packaging: blister on card

article no.	EAN	description	product dimensions
4685000	4006885... ...468504	1 accumobil - mobile drilling aid	117 x 66 x 33 mm

6 POWER TOOL ACCESSORIES

6.11 Attachments



For precise 90° plunge angle

- drilling at right angles, even for inexperienced users
- for forstner and cylinder drills up to Ø 35 mm and use of bit holders up to Ø 10 mm
- stable hold on tools on smooth surfaces thanks to rubber buffer
- positioning lines for drilling precise boreholes
- with V-groove for drilling into pipes as well as square and round timber
- side lay for precise batch drilling
- generous surfaces for fastening the drill guide with C-clamps (e.g. for drilling hinge bores)
- separate accessories: 4681000, 4682000
- packaging: blister on card



article no.	EAN	description
4686000	4006885... ...468603	1 mobile drilling aid for forstner and cylinder drills as well as bit holders



- suitable for mobile drilling aid 4686000
- adapter with supply air regulation for connection to a commercially available vacuum cleaner
- for extracting fine dust or wood particles when drilling or countersinking
- not suitable for use with materials that produce coarse chips
- packaging: blister on card



article no.	EAN	description
4682000	4006885... ...468207	1 suction adapter with hose



- especially suitable for depth-restricted use of tools in the mobile drilling aid 4686000
- for all drills with Ø 8, 10, 12 mm
- for all forstner or cylinder drills with 8, 10 or 12 mm shank diameter
- for all bit holders with sleeves of 8, 10, 12 mm Ø
- packaging: blister on card



article no.	EAN	description	Ø
4681000	4006885... ...468108	3 depth stops	Ø 8, 10, 12 mm

POWER TOOL ACCESSORIES 6

6.11 Attachments

Routing attachments



- machine: power drills
- for milling grooves, slots and profiles
- shank: \varnothing 8 mm
- including: 1 slotting cutter, \varnothing 35 mm, 2,5 mm
- packaging: covering box
- separate accessories: 3258000, 3259000, 3260000, 3261000, 3263000, 3264000, 3266000, 3267000



article no.	EAN	description	product dimensions
3001000	4006885... ...300101	1 wood shaper drill attachment	140 x 200 x 55 mm

Pumps



- machine: power drills
- metal casing
- version: self-priming
- thread connection: 19 mm (3/4")
- hose connection: 1/2" (12,7 mm), 19 mm (3/4")
- shank: \varnothing 8 mm
- packaging: paperboard card



article no.	EAN	description	max. capacity	hose connection / pumping height	suction lift	dry running
2200000	4006885... ...220003	1 pump	3,000 l/h	Hose 1/2" (13 mm) / 30 m Hose 3/4" (19 mm) / 24 m	3 m	30 s

6 POWER TOOL ACCESSORIES

6.11 Attachments



- machine: power drills
- plastic case
- version: self-priming
- thread connection: 19 mm (3/4")
- hose connection: 1/2" (12,7 mm), 19 mm (3/4")
- shank: ø 8 mm
- packaging: paperboard card



article no.	EAN	description	max. capacity	hose connection / pumping height	suction lift	dry running
2207000	4006885... ...220706	1 pump	3,000 l/h	Hose 1/2" (13 mm) / 24 m Hose 3/4" (19 mm) / 18 m	3 m	30 s



- machine: power drills
- plastic case
- version: self-priming
- hose connection: 1/2" (12,7 mm)
- shank: ø 6 mm
- packaging: paperboard card



article no.	EAN	description	max. capacity	hose connection / pumping height	suction lift	dry running
2202000	4006885... ...220201	1 pump	1,300 l/h	Hose 1/2" (13 mm) / 15 m	3 m	30 s

POWER TOOL ACCESSORIES 6
6.11 Attachments

Universal drill clamps



- machine: power drills
- for stationary use of power drills, milling and grinding motors in any position
- adjustable for 360° in horizontal and 90° in vertical direction
- material: die-cast aluminium
- Euronorm collar ø 43 mm
- packaging: paperboard card

article no.	EAN	description
4800000	4006885... ...480001	1 universal drill clamp



- machine: power drills
- for stationary use of power drills, milling and grinding motors in horizontal and vertical position
- rotating
- material: plastic material
- Euronorm collar ø 43 mm
- packaging: paperboard card

article no.	EAN	description
4802000	4006885... ...480209	1 universal drill clamp

6.12 Drills / Chisels



POWER TOOL ACCESSORIES 6

6.12 Drills / Chisels

Metal drills

HSSCo Metal drills



- for boreholes in extremely hard and very abrasive (abrading) materials
- for stainless HCS steel, annealed cast iron, bronze, sheet steel, car bodies, plastic materials, metals, hard materials
- high true running accuracy and break resistance
- highest durability under highest loads
- extremely heat-resistant
- according to DIN 338
- version: precision ground
- material: HSS-Co
- point angle: 130°
- spiral section with decreasing diameter
- packaging: plastic bag on card



article no.	EAN 4006885...	description	∅	spiral length	length
7443010	...744301	1 metal drill	∅ 2 mm	24 mm	49 mm
7444010	...744400	1 metal drill	∅ 2.5 mm	30 mm	57 mm
7445010	...744509	1 metal drill	∅ 3 mm	33 mm	61 mm
7446010	...744608	1 metal drill	∅ 3.2 mm	36 mm	65 mm
7448010	...744806	1 metal drill	∅ 3.5 mm	39 mm	70 mm
7450010	...745001	1 metal drill	∅ 4 mm	43 mm	75 mm
7451010	...745100	1 metal drill	∅ 4.2 mm	43 mm	75 mm
7452010	...745209	1 metal drill	∅ 4.5 mm	47 mm	80 mm
7453010	...745308	1 metal drill	∅ 4.8 mm	52 mm	86 mm
7454010	...745407	1 metal drill	∅ 5 mm	52 mm	86 mm
7455010	...745506	1 metal drill	∅ 5.5 mm	57 mm	93 mm
7456010	...745605	1 metal drill	∅ 6 mm	57 mm	93 mm
7457010	...745704	1 metal drill	∅ 6.5 mm	63 mm	101 mm
7458010	...745803	1 metal drill	∅ 7 mm	69 mm	109 mm
7459010	...745902	1 metal drill	∅ 7.5 mm	69 mm	109 mm
7460010	...746008	1 metal drill	∅ 8 mm	75 mm	117 mm
7461010	...746107	1 metal drill	∅ 8.5 mm	75 mm	117 mm
7462010	...746206	1 metal drill	∅ 9 mm	81 mm	125 mm
7463010	...746305	1 metal drill	∅ 9.5 mm	81 mm	125 mm
7464010	...746404	1 metal drill	∅ 10 mm	87 mm	133 mm



article no.	EAN 4006885...	description	∅	in	product dimensions
7118000	...711808	6 metal drills	∅ 2, 3, 4, 5, 6, 8 mm	2-component plastic slide-out box	68 x 150 x 18 mm

6.12 Drills / Chisels

HSS Metal drills precision ground



- for steel, cast steel, annealed cast iron, grey cast iron, non-ferrous metals, plastic materials
- high durability under high loads
- according to DIN 338
- version: precision ground
- material: HSS
- point angle: 118°
- spiral section with decreasing diameter and increasing core
- packaging: plastic bag on card

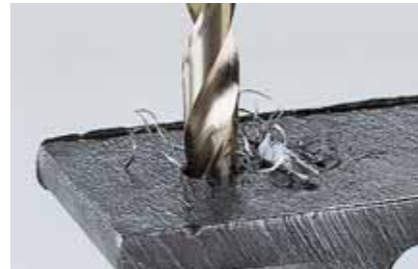

article no.	EAN 4006885...	description	Ø	spiral length	length
7541010	...754102	3 metal drills	Ø 1 mm	12 mm	34 mm
7542010	...754201	3 metal drills	Ø 1.5 mm	18 mm	40 mm
7543010	...754300	3 metal drills	Ø 2 mm	24 mm	49 mm
7544010	...754409	3 metal drills	Ø 2.5 mm	30 mm	57 mm
7545010	...754508	3 metal drills	Ø 3 mm	33 mm	61 mm
7536010	...753600	1 metal drill	Ø 3.1 mm	36 mm	65 mm
7546010	...754607	1 metal drill	Ø 3.2 mm	36 mm	65 mm
7548010	...754805	1 metal drill	Ø 3.5 mm	39 mm	70 mm
7550010	...755000	1 metal drill	Ø 4 mm	43 mm	75 mm
7537010	...753709	1 metal drill	Ø 4.1 mm	43 mm	75 mm
7551010	...755109	1 metal drill	Ø 4.2 mm	43 mm	75 mm
7552010	...755208	1 metal drill	Ø 4.5 mm	47 mm	80 mm
7554010	...755406	1 metal drill	Ø 5 mm	52 mm	86 mm
7538010	...753808	1 metal drill	Ø 5.1 mm	52 mm	86 mm
7555010	...755505	1 metal drill	Ø 5.5 mm	57 mm	93 mm
7556010	...755604	1 metal drill	Ø 6 mm	57 mm	93 mm
7557010	...755703	1 metal drill	Ø 6.5 mm	63 mm	101 mm
7558010	...755802	1 metal drill	Ø 7 mm	69 mm	109 mm
7560010	...756007	1 metal drill	Ø 8 mm	75 mm	117 mm
7561010	...756106	1 metal drill	Ø 8.5 mm	75 mm	117 mm
7562010	...756205	1 metal drill	Ø 9 mm	81 mm	125 mm
7564010	...756403	1 metal drill	Ø 10 mm	87 mm	133 mm
7565010	...756502	1 metal drill	Ø 10.5 mm	87 mm	133 mm
7566010	...756601	1 metal drill	Ø 11 mm	94 mm	142 mm
7568010	...756809	1 metal drill	Ø 12 mm	101 mm	151 mm
7569010	...756908	1 metal drill	Ø 12.5 mm	101 mm	151 mm
7570010	...757004	1 metal drill	Ø 13 mm	101 mm	151 mm
7572010	...757202	1 metal drill	Ø 14 mm	108 mm	160 mm
7573010	...757301	1 metal drill	Ø 15 mm	114 mm	169 mm
7574010	...757400	1 metal drill	Ø 16 mm	120 mm	178 mm

POWER TOOL ACCESSORIES

6.12 Drills / Chisels

6



article no.	EAN	description	Ø	in	product dimensions
7101000	4006885... ...710108	6 metal drills	Ø 2, 3, 4, 5, 6, 8 mm	2-component plastic slide-out box	68 x 150 x 18 mm
7100000	...710009	13 metal drills	Ø 1.5, 2, 2.5, 3, 3.3, 3.5, 4, 4.2, 4.5, 5, 5.5, 6, 6.5 mm	2-component plastic slide-out box	110 x 150 x 18 mm
7102000	...710207	13 metal drills	Ø 2, 2.5, 3, 3.2, 3.5, 4, 4.5, 5, 5.5, 6, 6.5, 7, 8 mm	2-component plastic slide-out box	110 x 150 x 18 mm

HSS Metal drills precision ground with hexagonal shank



- for steel, cast steel, annealed cast iron, grey cast iron, non-ferrous metals, plastic materials
- 1/4" hexagonal shank (E6.3) for quick tool changes in bit holders
- high durability under high loads
- according to DIN 338
- version: precision ground
- material: HSS
- point angle: 118°
- spiral section with decreasing diameter and increasing core
- packaging: plastic bag with inlay

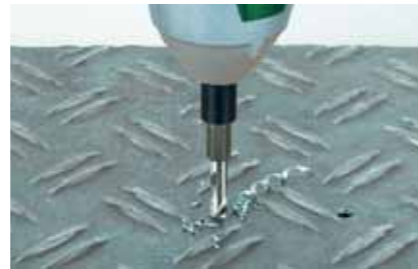

article no.	EAN	description	Ø	spiral length	length
7256000	4006885... ...725607	1 metal drill	Ø 2 mm	16 mm	47 mm
7124000	...712409	1 metal drill	Ø 2 mm	24 mm	62 mm
7125000	...712508	1 metal drill	Ø 2.5 mm	30 mm	70 mm
7257000	...725706	1 metal drill	Ø 3 mm	16 mm	47 mm
7126000	...712607	1 metal drill	Ø 3 mm	33 mm	74 mm
7127000	...712706	1 metal drill	Ø 3.5 mm	39 mm	83 mm
7258000	...725805	1 metal drill	Ø 4 mm	20 mm	53 mm
7128000	...712805	1 metal drill	Ø 4 mm	43 mm	88 mm
7259000	...725904	1 metal drill	Ø 5 mm	26 mm	59 mm
7129000	...712904	1 metal drill	Ø 5 mm	52 mm	99 mm
7260000	...726000	1 metal drill	Ø 6 mm	26 mm	59 mm
7130000	...713000	1 metal drill	Ø 6 mm	63 mm	106 mm

6 POWER TOOL ACCESSORIES

6.12 Drills / Chisels



article no.	EAN	description	Ø	in	product dimensions
7121000	4006885... ...712102	5 metal drills	Ø 2, 3, 4, 5, 6 mm	2-component plastic slide-out box	68 x 150 x 18 mm

HSS Metal drills rolled



- for steel, cast iron, non-ferrous metals, plastic materials
- according to DIN 338
- version: rolled, conical envelope grinding
- material: HSS
- point angle: 118°
- packaging: plastic bag on card



article no.	EAN	description	Ø	spiral length	length
7491010	...749108	3 metal drills	Ø 1 mm	12 mm	34 mm
7492010	...749207	3 metal drills	Ø 1.5 mm	18 mm	40 mm
7493010	...749306	3 metal drills	Ø 2 mm	24 mm	49 mm
7494010	...749405	3 metal drills	Ø 2.5 mm	30 mm	57 mm
7495010	...749504	3 metal drills	Ø 3 mm	33 mm	61 mm
7496010	...749603	1 metal drill	Ø 3.2 mm	36 mm	65 mm
7498010	...749801	1 metal drill	Ø 3.5 mm	39 mm	70 mm
7500010	...750005	1 metal drill	Ø 4 mm	43 mm	75 mm
7501010	...750104	1 metal drill	Ø 4.2 mm	43 mm	75 mm
7502010	...750203	1 metal drill	Ø 4.5 mm	47 mm	80 mm
7504010	...750401	1 metal drill	Ø 5 mm	52 mm	86 mm
7505010	...750500	1 metal drill	Ø 5.5 mm	57 mm	93 mm
7506010	...750609	1 metal drill	Ø 6 mm	57 mm	93 mm
7507010	...750708	1 metal drill	Ø 6.5 mm	63 mm	101 mm
7508010	...750807	1 metal drill	Ø 7 mm	69 mm	109 mm
7509010	...750906	1 metal drill	Ø 7.5 mm	69 mm	109 mm
7510010	...751002	1 metal drill	Ø 8 mm	75 mm	117 mm
7511010	...751101	1 metal drill	Ø 8.5 mm	75 mm	117 mm
7512010	...751200	1 metal drill	Ø 9 mm	81 mm	125 mm
7514010	...751408	1 metal drill	Ø 10 mm	87 mm	133 mm
7515010	...751507	1 metal drill	Ø 10.5 mm	87 mm	133 mm
7516010	...751606	1 metal drill	Ø 11 mm	94 mm	142 mm
7518010	...751804	1 metal drill	Ø 12 mm	101 mm	151 mm
7520010	...752009	1 metal drill	Ø 13 mm	101 mm	151 mm
7530010	...753006	1 metal drill	Ø 14 mm	108 mm	160 mm
7534010	...753402	1 metal drill	Ø 15 mm	114 mm	169 mm



POWER TOOL ACCESSORIES

6.12 Drills / Chisels

6



article no.	EAN	description	∅	spiral length	length
7535010	...753501	1 metal drill	∅ 16 mm	120 mm	178 mm



7105000



8453000



8632000



7104000



7106000



7103000



8614000

article no.	EAN	description	∅	in	product dimensions
7105000	...710504	6 metal drills	∅ 2, 3, 4, 5, 6, 8 mm	2-component plastic slide-out box	68 x 150 x 18 mm
8453000	...845305	6 metal drills	∅ 2, 3, 4, 5, 6, 8 mm	plastic box	56 x 160 x 18 mm
8632000	...863200	6 metal drills	∅ 2, 3, 4, 5, 6, 8 mm	2-component plastic slide-out box	70 x 150 x 17 mm
7104000	...710405	13 metal drills	∅ 1.5, 2, 2.5, 3, 3.3, 3.5, 4, 4.2, 4.5, 5, 5.5, 6, 6.5 mm	2-component plastic slide-out box	110 x 150 x 18 mm
7106000	...710603	13 metal drills	∅ 2, 2.5, 3, 3.2, 3.5, 4, 4.5, 5, 5.5, 6, 6.5, 7, 8 mm	2-component plastic slide-out box	110 x 150 x 18 mm
7103000	...710306	16 metal drills	∅ 1, 1.5, 2, 2.5, 3, 3.2, 3.5, 4, 4.2, 4.5, 5, 6, 7, 8, 9, 10 mm	2-component plastic box with lid	112 x 187 x 34 mm
8614000	...861404	16 metal drills	∅ 1, 1.5, 2, 2.5, 3, 3.2, 3.5, 4, 4.2, 4.5, 5, 6, 7, 8, 9, 10 mm	2-component plastic box with lid	115 x 190 x 34 mm

HSS Metal drills rolled, long



- for steel, cast iron, non-ferrous metals, plastic materials
- according to DIN 340
- version: rolled, long
- material: HSS
- point angle: 118°
- packaging: plastic bag on card



article no.	EAN	description	∅	spiral length	length
7587010	...758704	1 metal drill	∅ 3 mm	66 mm	100 mm



6.12 Drills / Chisels



article no.	EAN 4006885...	description	Ø	spiral length	length
7591010	...759107	1 metal drill	ø 4 mm	78 mm	119 mm
7594010	...759404	1 metal drill	ø 5 mm	87 mm	132 mm
7596010	...759602	1 metal drill	ø 6 mm	91 mm	139 mm
7599010	...759909	1 metal drill	ø 8 mm	109 mm	165 mm
7602010	...760202	1 metal drill	ø 10 mm	121 mm	184 mm

Wood drills

HSS-Wood twist drills "Professional"



- particularly suitable for use in furniture making or wooden terrace construction
- for wood, hardwood, terrace wood
- for extremely hard woods
- with 2 guide chamfers for improved drill hole guidance
- with large chip guide groove for optimum chip removal
- version: with self-cutting centre point
- material: HSS
- packaging: storage box on card

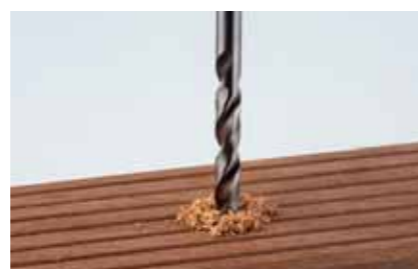

article no.	EAN 4006885...	description	Ø	spiral length	length
7246000	...724600	1 wood twist drill "Professional"	ø 4 mm	43 mm	75 mm
7247000	...724709	1 wood twist drill "Professional"	ø 5 mm	52 mm	86 mm
7248000	...724808	1 wood twist drill "Professional"	ø 6 mm	57 mm	94 mm
7249000	...724907	1 wood twist drill "Professional"	ø 8 mm	75 mm	117 mm
7250000	...725003	1 wood twist drill "Professional"	ø 10 mm	87 mm	133 mm
7251000	...725102	1 wood twist drill "Professional"	ø 12 mm	101 mm	151 mm
7252000	...725201	1 wood twist drill "Professional"	ø 14 mm	101 mm	160 mm
7253000	...725300	1 wood twist drill "Professional"	ø 16 mm	110 mm	160 mm
7254000	...725409	1 wood twist drill "Professional"	ø 18 mm	120 mm	180 mm
7255000	...725508	1 wood twist drill "Professional"	ø 20 mm	130 mm	200 mm



article no.	EAN 4006885...	description	Ø	in	product dimensions
7120000	...712003	6 wood twist drills "Professional"	ø 3, 4, 5, 6, 8, 10 mm	2-component plastic slide-out box	68 x 150 x 18 mm

POWER TOOL ACCESSORIES

6.12 Drills / Chisels

6

CV-Wood twist drills



- for wood, plywood, chipboards, fibre boards
- high durability
- version: cylindrically ground, ground centre point, ground pre-cutting edge
- material: CV
- packaging: plastic bag on card



article no.	EAN 4006885...	description	Ø	spiral length	length
7603010	...760301	1 wood twist drill	Ø 3 mm	33 mm	61 mm
7604010	...760400	1 wood twist drill	Ø 4 mm	43 mm	75 mm
7605010	...760509	1 wood twist drill	Ø 5 mm	52 mm	86 mm
7606010	...760608	1 wood twist drill	Ø 6 mm	57 mm	94 mm
7607010	...760707	1 wood twist drill	Ø 7 mm	69 mm	109 mm
7608010	...760806	1 wood twist drill	Ø 8 mm	75 mm	117 mm
7610010	...761001	1 wood twist drill	Ø 10 mm	87 mm	133 mm
7612010	...761209	1 wood twist drill	Ø 12 mm	96 mm	151 mm
7614010	...761407	1 wood twist drill	Ø 14 mm	97 mm	151 mm
7615010	...761506	1 wood twist drill	Ø 15 mm	100 mm	160 mm
7616010	...761605	1 wood twist drill	Ø 16 mm	100 mm	180 mm
7618010	...761803	1 wood twist drill	Ø 18 mm	120 mm	180 mm
7619010	...761902	1 wood twist drill	Ø 20 mm	130 mm	200 mm



8458000



7107000



7108000



8635000

article no.	EAN 4006885...	description	Ø	including	in	product dimensions
8458000	...845800	5 wood twist drills	Ø 4, 5, 6, 8, 10 mm		plastic box	56 x 160 x 18 mm
7107000	...710702	6 wood twist drills	Ø 3, 4, 5, 6, 8, 10 mm	1 countersink, Ø 12 mm	2-component plastic slide-out box	110 x 150 x 18 mm
7108000	...710801	6 wood twist drills	Ø 3, 4, 5, 6, 8, 10 mm		2-component plastic slide-out box	68 x 150 x 18 mm
8635000	...863507	6 wood twist drills	Ø 3, 4, 5, 6, 8, 10 mm		2-component plastic slide-out box	70 x 150 x 17 mm

6.12 Drills / Chisels

CV-Wood twist drills with hexagonal shank



- for wood, plywood, chipboards, fibre boards
- 1/4" hexagonal shank (E6.3) for quick tool changes in bit holders
- high durability
- version: cylindrically ground, ground centre point, ground pre-cutting edge
- material: CV
- packaging: plastic bag with inlay



article no.	EAN	description	Ø	spiral length	length
7261000	4006885... ...726109	1 wood twist drill	Ø 3 mm	35 mm	65 mm
7262000	...726208	1 wood twist drill	Ø 4 mm	40 mm	75 mm
7263000	...726307	1 wood twist drill	Ø 5 mm	50 mm	85 mm
7264000	...726406	1 wood twist drill	Ø 6 mm	55 mm	90 mm



article no.	EAN	description	Ø	in	product dimensions
7122000	4006885... ...712201	5 wood twist drills	Ø 3, 4, 5, 6, 8 mm	2-component plastic slide-out box	68 x 150 x 18 mm

Wooden beam drills

"Standard" wooden beam drill



- for wood beams and joints, thick wooden parts
- highly annealed steel quality
- hardened cutting edges for high durability
- spiral centre point
- precision ground pre-cutting edges and cutting edges
- extra deep rounded-off grooves for the optimal chip discharge
- packaging: plastic bag on card



article no.	EAN 4006885...	description	Ø	spiral length	length	shank
7659010	...765900	1 "Standard" wooden beam drill	Ø 6 mm	190 mm	250 mm	hexagon shank
7658010	...765801	1 "Standard" wooden beam drill	Ø 8 mm	190 mm	250 mm	hexagon shank
7660010	...766006	1 "Standard" wooden beam drill	Ø 10 mm	190 mm	250 mm	hexagon shank
7661010	...766105	1 "Standard" wooden beam drill	Ø 12 mm	190 mm	250 mm	hexagon shank
7662010	...766204	1 "Standard" wooden beam drill	Ø 14 mm	190 mm	250 mm	hexagon shank
7663010	...766303	1 "Standard" wooden beam drill	Ø 16 mm	190 mm	250 mm	hexagon shank
7664010	...766402	1 "Standard" wooden beam drill	Ø 18 mm	190 mm	250 mm	hexagon shank
7665010	...766501	1 "Standard" wooden beam drill	Ø 20 mm	190 mm	250 mm	hexagon shank
7667010	...766709	1 "Standard" wooden beam drill	Ø 6 mm	325 mm	400 mm	hexagon shank
7668010	...766808	1 "Standard" wooden beam drill	Ø 8 mm	325 mm	400 mm	hexagon shank
7670010	...767003	1 "Standard" wooden beam drill	Ø 10 mm	325 mm	400 mm	hexagon shank
7671010	...767102	1 "Standard" wooden beam drill	Ø 12 mm	325 mm	400 mm	hexagon shank
7672010	...767201	1 "Standard" wooden beam drill	Ø 14 mm	325 mm	400 mm	hexagon shank
7673010	...767300	1 "Standard" wooden beam drill	Ø 16 mm	325 mm	400 mm	hexagon shank
7674010	...767409	1 "Standard" wooden beam drill	Ø 18 mm	325 mm	400 mm	hexagon shank
7675010	...767508	1 "Standard" wooden beam drill	Ø 20 mm	325 mm	400 mm	hexagon shank
7676010	...767607	1 "Standard" wooden beam drill	Ø 22 mm	325 mm	400 mm	hexagon shank

6.12 Drills / Chisels

"speedwinder" wooden beam drill



- for wooden beams, thick wooden parts
- super-fast drilling progress thanks to specially ground blades
- hexagonal shank for quick tool changes
- especially suitable for use in cordless power tools
- packaging: plastic bag on card



article no.	EAN 4006885...	description	Ø	spiral length	length	shank
7131000	...713109	1 "speedwinder" wooden beam drill	ø 6 mm	90 mm	165 mm	hexagon shank 1/4" (6,35 mm)
7132000	...713208	1 "speedwinder" wooden beam drill	ø 8 mm	90 mm	165 mm	hexagon shank 1/4" (6,35 mm)
7133000	...713307	1 "speedwinder" wooden beam drill	ø 10 mm	90 mm	165 mm	hexagon shank 1/4" (6,35 mm)
7134000	...713406	1 "speedwinder" wooden beam drill	ø 12 mm	90 mm	165 mm	hexagon shank 1/4" (6,35 mm)
7135000	...713505	1 "speedwinder" wooden beam drill	ø 14 mm	90 mm	165 mm	hexagon shank 1/4" (6,35 mm)
7136000	...713604	1 "speedwinder" wooden beam drill	ø 16 mm	90 mm	165 mm	hexagon shank 1/4" (6,35 mm)
7137000	...713703	1 "speedwinder" wooden beam drill	ø 18 mm	90 mm	165 mm	hexagon shank 1/4" (6,35 mm)
7138000	...713802	1 "speedwinder" wooden beam drill	ø 20 mm	90 mm	165 mm	hexagon shank 1/4" (6,35 mm)
7139000	...713901	1 "speedwinder" wooden beam drill	ø 26 mm	90 mm	165 mm	hexagon shank
7140000	...714007	1 "speedwinder" wooden beam drill	ø 30 mm	90 mm	165 mm	hexagon shank

CV-Formwork twist drills



- for drilling of holes for clamping screws or tensioning wire on formwork for concrete
- open helical outlet from ø 16 mm
- threaded connection between drill and shank
- conical transition from shank to drill
- according to DIN 7490
- material: CV
- point angle: 118°
- packaging: plastic bag on card



article no.	EAN 4006885...	description	Ø	spiral length	length	shank
7680010	...768000	1 formwork twist drill	ø 8 mm	75 mm	400 mm	ø 6 mm
7681010	...768109	1 formwork twist drill	ø 10 mm	87 mm	400 mm	ø 8 mm
7682010	...768208	1 formwork twist drill	ø 12 mm	100 mm	400 mm	ø 8 mm



POWER TOOL ACCESSORIES

6.12 Drills / Chisels

6



article no.	EAN 4006885...	description	Ø	spiral length	length	shank
7683010	...768307	1 formwork twist drill	Ø 14 mm	110 mm	400 mm	Ø 8 mm
7684010	...768406	1 formwork twist drill	Ø 16 mm	100 mm	400 mm	Ø 10 mm
7686010	...768604	1 formwork twist drill	Ø 20 mm	100 mm	400 mm	Ø 10 mm

Flat milling drills



- for wood, plywood, chipboards, fibre boards
- hardened for high durability
- sharpened centre point
- ground cutting edges
- material: tool steel
- packaging: paperboard card
- separate accessories: 7629000



article no.	EAN 4006885...	description	Ø	length	shank
7634000	...763401	1 flat milling drill	Ø 14 mm	152 mm	hexagon shank 1/4" (6,35 mm)
7635000	...763500	1 flat milling drill	Ø 16 mm	152 mm	hexagon shank 1/4" (6,35 mm)
7636000	...763609	1 flat milling drill	Ø 18 mm	152 mm	hexagon shank 1/4" (6,35 mm)
7638000	...763807	1 flat milling drill	Ø 20 mm	152 mm	hexagon shank 1/4" (6,35 mm)
7639000	...763906	1 flat milling drill	Ø 22 mm	152 mm	hexagon shank 1/4" (6,35 mm)
7641000	...764101	1 flat milling drill	Ø 25 mm	152 mm	hexagon shank 1/4" (6,35 mm)
7643000	...764309	1 flat milling drill	Ø 30 mm	152 mm	hexagon shank 1/4" (6,35 mm)
7646000	...764606	1 flat milling drill	Ø 35 mm	152 mm	hexagon shank 1/4" (6,35 mm)



- for flat milling drills
- packaging: plastic bag on card
- suitable for 7634000, 7635000, 7636000, 7638000, 7639000, 7641000, 7643000, 7646000



article no.	EAN 4006885...	description	length	shank
7629000	...762909	1 extension shank	270 mm	hexagon shank

6.12 Drills / Chisels

TCT-Cylinder drills



Hinge bore drill for highest demands and high durability

- for formica, coated boards, chipboards, wood, plastic materials
- version: with pre-cutters, centre point
- material: TCT
- shank: \varnothing 8 mm
- packaging: blister on card

article no.	EAN 4006885...	description	\varnothing	length
3374000	...337404	1 cylinder drill	\varnothing 26 mm	90 mm
3376000	...337602	1 cylinder drill	\varnothing 35 mm	90 mm

WS-Cylinder drills



- for all types of wood
- version: with pre-cutters, centre point
- material: tool steel
- shank: \varnothing 8 mm
- packaging: blister on card

article no.	EAN 4006885...	description	\varnothing	length
3305000	...330504	1 cylinder drill	\varnothing 20 mm	53 mm
3306000	...330603	1 cylinder drill	\varnothing 25 mm	53 mm
3300000	...330009	1 cylinder drill	\varnothing 26 mm	53 mm
3301000	...330108	1 cylinder drill	\varnothing 30 mm	53 mm
3302000	...330207	1 cylinder drill	\varnothing 35 mm	53 mm
3303000	...330306	1 cylinder drill	\varnothing 40 mm	53 mm
3361000	...336100	1 cylinder drill	\varnothing 15 mm	90 mm
3362000	...336209	1 cylinder drill	\varnothing 20 mm	90 mm
3363000	...336308	1 cylinder drill	\varnothing 25 mm	90 mm
3364000	...336407	1 cylinder drill	\varnothing 26 mm	90 mm
3365000	...336506	1 cylinder drill	\varnothing 30 mm	90 mm
3366000	...336605	1 cylinder drill	\varnothing 35 mm	90 mm

POWER TOOL ACCESSORIES 6

6.12 Drills / Chisels

Forstner drills



Set for drilling hinge holes.

- content:
 - 1 forstner drill, ø 35 mm
 - 1 marking template, plastic material, for precise marking of the drilling points for concealed hinges and eccentric connectors Ø 26 and 35 mm
- packaging: blister on card

article no.	EAN	description	Ø	length	shank
8728000	4006885... ...872806	1 forstner drill	ø 35 mm	90 mm	ø 10 mm



special cutting edge geometry

The special cutting edge geometry of wolcraft's Forstner drill prevents unintentional heat while drilling. The drilling result is accurate and without any scorch marks on the workpiece.

- for drilling tear-free & precise holes to measure
- edge holes in all types of soft wood and plastic-coated chipboard
- special cutting edge geometry = shorter drilling time = no burned spots in the wood
- drilling with less energy = extends the machine's service life
- version: with centre point, 2 main cutting edges, pinnacle-type peripheral cutting edges
- material: high-quality tool steel
- packaging: double blister

article no.	EAN	description	Ø	length	shank
3313000	4006885... ...331303	1 forstner drill	ø 15 mm	90 mm	ø 8 mm
3315000	...331501	1 forstner drill	ø 20 mm	90 mm	ø 8 mm
3316000	...331600	1 forstner drill	ø 22 mm	90 mm	ø 8 mm
3317000	...331709	1 forstner drill	ø 25 mm	90 mm	ø 8 mm
3318000	...331808	1 forstner drill	ø 26 mm	90 mm	ø 8 mm
3319000	...331907	1 forstner drill	ø 28 mm	90 mm	ø 8 mm
3320000	...332003	1 forstner drill	ø 30 mm	90 mm	ø 8 mm
3321000	...332102	1 forstner drill	ø 32 mm	90 mm	ø 10 mm
3322000	...332201	1 forstner drill	ø 35 mm	90 mm	ø 10 mm
3325000	...332508	1 forstner drill	ø 40 mm	90 mm	ø 10 mm
3326000	...332607	1 forstner drill	ø 45 mm	90 mm	ø 10 mm
3328000	...332805	1 forstner drill	ø 48 mm	90 mm	ø 10 mm
3327000	...332706	1 forstner drill	ø 50 mm	90 mm	ø 10 mm

6 POWER TOOL ACCESSORIES

6.12 Drills / Chisels



article no.	EAN	description	∅	shank	in	product dimensions
1002000	4006885... ...100206	5 forstner drills	∅ 15, 20, 25, 30, 35 mm	∅ 10 mm	2-component plastic case	165 x 127 x 47 mm

Forstner drills with hexagonal shank



- for soft wood, plastic coated chipboards
- precise holes thanks to a special cutting tooth geometry
- 1/4" hexagonal shank (E6.3) for quick tool changes in bit holders
- version: centre point, 2 main cutting edges, pinnacle-type peripheral cutting edges
- packaging: double blister

article no.	EAN	description	∅	length
3309000	4006885... ...330900	1 forstner drill	∅ 26 mm	90 mm
3310000	...331006	1 forstner drill	∅ 35 mm	90 mm

Masonry drills / Chisels

TCT-Rock drills "Professional"



- for brick walls, stone, concrete, marble, natural stones, ceramics
- straight inlet to spiral groove
- reinforced plate seat
- specially hardened
- impact and shock proof
- according to ISO 5468
- material: TCT
- point angle: 130°
- packaging: plastic bag on card



article no.	EAN 4006885...	description	Ø	spiral length	length
7774010	...777408	1 rock drill "Professional"	Ø 4 mm	40 mm	75 mm
7775010	...777507	1 rock drill "Professional"	Ø 5 mm	40 mm	85 mm
7776010	...777606	1 rock drill "Professional"	Ø 6 mm	55 mm	100 mm
7778010	...777804	1 rock drill "Professional"	Ø 8 mm	70 mm	120 mm
7780010	...778009	1 rock drill "Professional"	Ø 10 mm	70 mm	120 mm
7785010	...778504	1 rock drill "Professional"	Ø 5 mm	95 mm	150 mm
7786010	...778603	1 rock drill "Professional"	Ø 6 mm	95 mm	150 mm
7782010	...778207	1 rock drill "Professional"	Ø 12 mm	90 mm	150 mm
7784010	...778405	1 rock drill "Professional"	Ø 14 mm	90 mm	150 mm
7788010	...778801	1 rock drill "Professional"	Ø 8 mm	180 mm	250 mm
7789010	...778900	1 rock drill "Professional"	Ø 10 mm	180 mm	250 mm



article no.	EAN 4006885...	description	Ø	in	product dimensions
7119000	...711907	6 rock drills "Professional"	Ø 3, 4, 5, 6, 8, 10 mm	2-component plastic slide-out box	68 x 150 x 18 mm

6 POWER TOOL ACCESSORIES

6.12 Drills / Chisels

TCT-Special concrete drills



- for brick walls, stone, concrete, artificial stones, marble, ceramics
- precision-ground carbide cutting plate, diamond-ground
- special soldering method with copper
- heat-resistant up to 500° C
- extra deep ground spiral groove
- according to DIN 5468
- material: TCT
- point angle: 130°
- packaging: plastic bag on card



article no.	EAN 4006885...	description	Ø	spiral length	length
7743010	...774308	1 special concrete drill	Ø 3 mm	35 mm	70 mm
7744010	...774407	1 special concrete drill	Ø 4 mm	40 mm	75 mm
7745010	...774506	1 special concrete drill	Ø 5 mm	50 mm	85 mm
7746010	...774605	1 special concrete drill	Ø 6 mm	60 mm	100 mm
7747010	...774704	1 special concrete drill	Ø 7 mm	55 mm	100 mm
7748010	...774803	1 special concrete drill	Ø 8 mm	70 mm	120 mm
7749010	...774902	1 special concrete drill	Ø 9 mm	70 mm	120 mm
7750010	...775008	1 special concrete drill	Ø 10 mm	70 mm	120 mm
7752010	...775206	1 special concrete drill	Ø 12 mm	80 mm	150 mm
7754010	...775404	1 special concrete drill	Ø 14 mm	85 mm	150 mm
7756010	...775602	1 special concrete drill	Ø 16 mm	85 mm	160 mm



8616000



7110000



7109000

article no.	EAN 4006885...	description	Ø	miscellaneous	in	product dimensions
8616000	...861602	10 special concrete drills	Ø 3, 4, 5, 5, 6, 6, 8, 8, 9, 10 mm	in high-quality storage box	plastic box	115 x 190 x 34 mm
7110000	...711006	6 special concrete drills	Ø 3, 4, 5, 6, 8, 10 mm		2-component plastic slide-out box	68 x 150 x 18 mm
7109000	...710900	9 special concrete drills	Ø 3, 4, 5, 5, 6, 6, 8, 8, 10 mm		2-component plastic slide-out box	110 x 150 x 18 mm

POWER TOOL ACCESSORIES

6.12 Drills / Chisels

6

TCT-Rock drills



- for brick walls, stone, concrete, marble, tiles
- high-quality steel
- hardened, strong, wear-resistant
- according to DIN 5468
- version: rolled
- material: TCT
- point angle: 130°
- packaging: plastic bag on card



article no.	EAN 4006885...	description	Ø	spiral length	length
7703010	...770300	1 rock drill	Ø 3 mm	30 mm	60 mm
7704010	...770409	1 rock drill	Ø 4 mm	40 mm	70 mm
7705010	...770508	1 rock drill	Ø 5 mm	50 mm	85 mm
7706010	...770607	1 rock drill	Ø 6 mm	60 mm	100 mm
7707010	...770706	1 rock drill	Ø 7 mm	60 mm	100 mm
7708010	...770805	1 rock drill	Ø 8 mm	80 mm	120 mm
7709010	...770904	1 rock drill	Ø 9 mm	80 mm	120 mm
7710010	...771000	1 rock drill	Ø 10 mm	80 mm	120 mm
7712010	...771208	1 rock drill	Ø 12 mm	90 mm	150 mm
7714010	...771406	1 rock drill	Ø 14 mm	90 mm	150 mm
7716010	...771604	1 rock drill	Ø 16 mm	90 mm	150 mm
7736010	...773608	1 rock drill	Ø 6 mm	135 mm	200 mm
7737010	...773707	1 rock drill	Ø 8 mm	135 mm	200 mm
7738010	...773806	1 rock drill	Ø 10 mm	135 mm	200 mm



article no.	EAN 4006885...	description	Ø	in	product dimensions
8450000	...845008	5 rock drills	Ø 4, 5, 6, 8, 10 mm	plastic box	56 x 160 x 18 mm
7112000	...711204	6 rock drills	Ø 3, 4, 5, 6, 8, 10 mm	2-component plastic slide-out box	68 x 150 x 18 mm
8634000	...863408	6 rock drills	Ø 3, 4, 5, 6, 8, 10 mm	2-component plastic slide-out box	70 x 150 x 17 mm
7111000	...711105	9 rock drills	Ø 3, 4, 5, 5, 6, 6, 8, 8, 10 mm	2-component plastic slide-out box	110 x 150 x 18 mm

6.12 Drills / Chisels

TCT-Rock drills with hexagonal shank



- for brick walls, stone, concrete, marble, tiles
- 1/4" hexagonal shank (E6.3) for quick tool changes in bit holders
- high-quality steel
- hardened, strong, wear-resistant
- precision-ground hard metal plate
- according to DIN 5468
- material: TCT
- point angle: 130°
- packaging: plastic bag with inlay



article no.	EAN 4006885...	description	Ø	spiral length	length
7265000	...726505	1 rock drill	ø 4 mm	30 mm	80 mm
7266000	...726604	1 rock drill	ø 5 mm	40 mm	95 mm
7267000	...726703	1 rock drill	ø 6 mm	50 mm	110 mm
7269000	...726901	1 rock drill	ø 8 mm	50 mm	110 mm
7270000	...727007	1 rock drill	ø 10 mm	70 mm	120 mm



article no.	EAN 4006885...	description	Ø	in
7123000	...712300	5 rock drills	ø 4, 5, 6, 8, 10 mm	2-component plastic slide-out box

TCT-Masonry break-through drills with hexagonal shank



- machine: rotary and impact drills
- for brick walls, concrete, natural stones, artificial stones, marble, tiles
- high-quality steel
- strong core
- TCT cutting plate, tough, wear-resistant
- according to DIN 5468
- version: sand blasted
- material: TCT
- point angle: 130°
- packaging: plastic bag on card



article no.	EAN 4006885...	description	Ø	spiral length	length	shank
7918010	...791800	1 masonry break-through drill	ø 8 mm	300 mm	400 mm	hexagon shank
7920010	...792005	1 masonry break-through drill	ø 10 mm	300 mm	400 mm	hexagon shank
7922010	...792203	1 masonry break-through drill	ø 12 mm	300 mm	400 mm	hexagon shank
7924010	...792401	1 masonry break-through drill	ø 14 mm	300 mm	400 mm	hexagon shank
7926010	...792609	1 masonry break-through drill	ø 16 mm	300 mm	400 mm	hexagon shank
7928010	...792807	1 masonry break-through drill	ø 18 mm	300 mm	400 mm	hexagon shank
7932010	...793200	1 masonry break-through drill	ø 22 mm	300 mm	400 mm	hexagon shank
7940010	...794009	1 masonry break-through drill	ø 10 mm	450 mm	600 mm	hexagon shank
7942010	...794207	1 masonry break-through drill	ø 12 mm	450 mm	600 mm	hexagon shank
7917000	...791701	3 masonry break-through drills	ø 8, 10, 12 mm	300 mm	400 mm	hexagon shank

TCT rock drills with SDS-Quick shank

suitable for Bosch Uneo, Bosch Uneo Maxx



- machine: cordless hammer drills with SDS-Quick holder
- can also be used in standard three-jaw chucks
- for brick walls, concrete, natural stones, artificial stones, stone
- version: impact and shock proof
- material: TCT
- point angle: 130°
- packaging: plastic bag on card



article no.	EAN 4006885...	description	Ø	spiral length	length	shank
7760000	...776005	1 rock drill	ø 4 mm	40 mm	85 mm	SDS-Quick shank
7761000	...776104	1 rock drill	ø 5 mm	55 mm	100 mm	SDS-Quick shank
7762000	...776203	1 rock drill	ø 6 mm	55 mm	100 mm	SDS-Quick shank
7763000	...776302	1 rock drill	ø 8 mm	70 mm	120 mm	SDS-Quick shank
7764000	...776401	1 rock drill	ø 10 mm	70 mm	120 mm	SDS-Quick shank

6.12 Drills / Chisels

Hammer drills with SDS-plus shank "Professional 4-Cut"



- machine: hammer drills with SDS-plus holder
- for reinforced concrete, granite, brick walls, natural stones, artificial stones
- particularly suitable for reinforced concrete
- longer lifetime - special helix to reduce the vibration loads from hammer drilling
- longer service life - distribution of shearing forces on 2 levels through different cutting depths of main and auxiliary cutter
- optimal power transfer through laterally supported solid hard-metal head with 4 cutters and depth-offset seating in the drill body
- material: TCT
- in plastic box
- packaging: plastic clip



article no.	EAN 4006885...	description	Ø	spiral length	length	shank
7416000	...741607	1 hammer drill "Professional 4-Cut"	Ø 5 mm	50 mm	110 mm	SDS-plus
7418000	...741805	1 hammer drill "Professional 4-Cut"	Ø 6 mm	50 mm	110 mm	SDS-plus
7422000	...742208	1 hammer drill "Professional 4-Cut"	Ø 8 mm	50 mm	110 mm	SDS-plus
7417000	...741706	1 hammer drill "Professional 4-Cut"	Ø 5 mm	100 mm	160 mm	SDS-plus
7419000	...741904	1 hammer drill "Professional 4-Cut"	Ø 6 mm	100 mm	160 mm	SDS-plus
7423000	...742307	1 hammer drill "Professional 4-Cut"	Ø 8 mm	100 mm	160 mm	SDS-plus
7426000	...742604	1 hammer drill "Professional 4-Cut"	Ø 10 mm	100 mm	160 mm	SDS-plus
7429000	...742901	1 hammer drill "Professional 4-Cut"	Ø 12 mm	100 mm	160 mm	SDS-plus
7431000	...743106	1 hammer drill "Professional 4-Cut"	Ø 14 mm	100 mm	160 mm	SDS-plus
7420000	...742000	1 hammer drill "Professional 4-Cut"	Ø 6 mm	150 mm	210 mm	SDS-plus
7424000	...742406	1 hammer drill "Professional 4-Cut"	Ø 8 mm	150 mm	210 mm	SDS-plus
7427000	...742703	1 hammer drill "Professional 4-Cut"	Ø 10 mm	150 mm	210 mm	SDS-plus
7430000	...743007	1 hammer drill "Professional 4-Cut"	Ø 12 mm	150 mm	210 mm	SDS-plus
7434000	...743403	1 hammer drill "Professional 4-Cut"	Ø 24 mm	200 mm	250 mm	SDS-plus
7421000	...742109	1 hammer drill "Professional 4-Cut"	Ø 6 mm	200 mm	260 mm	SDS-plus
7440000	...744004	1 hammer drill "Professional 4-Cut"	Ø 6.5 mm	200 mm	260 mm	SDS-plus
7425000	...742505	1 hammer drill "Professional 4-Cut"	Ø 8 mm	200 mm	260 mm	SDS-plus
7428000	...742802	1 hammer drill "Professional 4-Cut"	Ø 10 mm	200 mm	260 mm	SDS-plus
7432000	...743205	1 hammer drill "Professional 4-Cut"	Ø 14 mm	200 mm	260 mm	SDS-plus
7433000	...743304	1 hammer drill "Professional 4-Cut"	Ø 16 mm	200 mm	260 mm	SDS-plus

POWER TOOL ACCESSORIES

6.12 Drills / Chisels

6

Hammer drills with SDS-plus shank "Professional"



- machine: hammer drills with SDS-plus holder
- for concrete, granite, brick walls, natural stones, artificial stones
- specially soldered, fully embedded TCT cutting plate with pronounced centring tip
- longer lifetime - special helix to reduce the vibration loads from hammer drilling
- higher drilling speed - the special helix will ensure the optimal transmission of the hammer drill's impact energy
- version: made of chrome-nickel-molybdenum steel, shot-peened and intermediate level hardened
- material: TCT
- packaging: plastic clip,
article no. 7998000, 7999000: plastic box



article no.	EAN 4006885...	description	Ø	spiral length	length	shank
7987000	...798700	1 hammer drill "Professional"	Ø 5 mm	50 mm	110 mm	SDS-plus
7988000	...798809	1 hammer drill "Professional"	Ø 6 mm	50 mm	110 mm	SDS-plus
7842000	...784208	1 hammer drill "Professional"	Ø 8 mm	50 mm	110 mm	SDS-plus
7841000	...784109	1 hammer drill "Professional"	Ø 5 mm	100 mm	160 mm	SDS-plus
7989000	...798908	1 hammer drill "Professional"	Ø 6 mm	100 mm	160 mm	SDS-plus
7998000	...799806	5 hammer drills "Professional"	Ø 6 mm	100 mm	160 mm	SDS-plus
7992000	...799202	1 hammer drill "Professional"	Ø 8 mm	100 mm	160 mm	SDS-plus
7999000	...799905	5 hammer drills "Professional"	Ø 8 mm	100 mm	160 mm	SDS-plus
7843000	...784307	1 hammer drill "Professional"	Ø 10 mm	100 mm	160 mm	SDS-plus
7844000	...784406	1 hammer drill "Professional"	Ø 12 mm	100 mm	160 mm	SDS-plus
7986000	...798601	1 hammer drill "Professional"	Ø 15 mm	100 mm	160 mm	SDS-plus
7990000	...799004	1 hammer drill "Professional"	Ø 6 mm	150 mm	210 mm	SDS-plus
7993000	...799301	1 hammer drill "Professional"	Ø 8 mm	150 mm	210 mm	SDS-plus
7995000	...799509	1 hammer drill "Professional"	Ø 10 mm	150 mm	210 mm	SDS-plus
7845000	...784505	1 hammer drill "Professional"	Ø 12 mm	150 mm	210 mm	SDS-plus
7849000	...784901	1 hammer drill "Professional"	Ø 14 mm	150 mm	210 mm	SDS-plus
7851000	...785106	1 hammer drill "Professional"	Ø 16 mm	150 mm	210 mm	SDS-plus
7991000	...799103	1 hammer drill "Professional"	Ø 6 mm	200 mm	260 mm	SDS-plus
7862000	...786202	1 hammer drill "Professional"	Ø 6.5 mm	200 mm	260 mm	SDS-plus
7994000	...799400	1 hammer drill "Professional"	Ø 8 mm	200 mm	260 mm	SDS-plus
7996000	...799608	1 hammer drill "Professional"	Ø 10 mm	200 mm	260 mm	SDS-plus
7846000	...784604	1 hammer drill "Professional"	Ø 12 mm	200 mm	260 mm	SDS-plus
7852000	...785205	1 hammer drill "Professional"	Ø 18 mm	250 mm	300 mm	SDS-plus
7853000	...785304	1 hammer drill "Professional"	Ø 20 mm	250 mm	300 mm	SDS-plus
7847000	...784703	1 hammer drill "Professional"	Ø 12 mm	400 mm	450 mm	SDS-plus
7860000	...786004	1 hammer drill "Professional"	Ø 20 mm	400 mm	450 mm	SDS-plus

6.12 Drills / Chisels

TCT-Hammer drills with SDS-plus shank "Standard"



- machine: hammer drills with SDS-plus holder
- for concrete, granite, brick walls, natural stones, artificial stones
- specially soldered, fully embedded TCT cutting plate
- helix and shank specially hardened
- material: TCT
- point angle: 130°
- packaging: plastic clip



article no.	EAN	description	Ø	spiral length	length	shank
7804010	...780408	1 hammer drill "Standard"	Ø 4 mm	50 mm	110 mm	SDS-plus
7805010	...780507	1 hammer drill "Standard"	Ø 5 mm	50 mm	110 mm	SDS-plus
7806010	...780606	1 hammer drill "Standard"	Ø 6 mm	50 mm	110 mm	SDS-plus
7812010	...781207	1 hammer drill "Standard"	Ø 8 mm	50 mm	110 mm	SDS-plus
7816010	...781603	1 hammer drill "Standard"	Ø 6 mm	100 mm	160 mm	SDS-plus
7817010	...781702	1 hammer drill "Standard"	Ø 7 mm	100 mm	160 mm	SDS-plus
7818010	...781801	1 hammer drill "Standard"	Ø 8 mm	100 mm	160 mm	SDS-plus
7819010	...781900	1 hammer drill "Standard"	Ø 9 mm	100 mm	160 mm	SDS-plus
7820010	...782006	1 hammer drill "Standard"	Ø 10 mm	100 mm	160 mm	SDS-plus
7822010	...782204	1 hammer drill "Standard"	Ø 12 mm	100 mm	160 mm	SDS-plus
7824010	...782402	1 hammer drill "Standard"	Ø 14 mm	100 mm	160 mm	SDS-plus
7838010	...783805	1 hammer drill "Standard"	Ø 18 mm	140 mm	200 mm	SDS-plus
7840010	...784000	1 hammer drill "Standard"	Ø 20 mm	140 mm	200 mm	SDS-plus
7828010	...782808	1 hammer drill "Standard"	Ø 6 mm	150 mm	210 mm	SDS-plus
7807010	...780705	1 hammer drill "Standard"	Ø 6.5 mm	150 mm	210 mm	SDS-plus
7830010	...783003	1 hammer drill "Standard"	Ø 8 mm	150 mm	210 mm	SDS-plus
7831010	...783102	1 hammer drill "Standard"	Ø 10 mm	150 mm	210 mm	SDS-plus
7832010	...783201	1 hammer drill "Standard"	Ø 12 mm	150 mm	210 mm	SDS-plus
7833010	...783300	1 hammer drill "Standard"	Ø 14 mm	150 mm	210 mm	SDS-plus
7834010	...783409	1 hammer drill "Standard"	Ø 16 mm	150 mm	210 mm	SDS-plus
7836010	...783607	1 hammer drill "Standard"	Ø 16 mm	190 mm	250 mm	SDS-plus
7854010	...785403	1 hammer drill "Standard"	Ø 8 mm	200 mm	260 mm	SDS-plus
7855010	...785502	1 hammer drill "Standard"	Ø 10 mm	200 mm	260 mm	SDS-plus
7856010	...785601	1 hammer drill "Standard"	Ø 12 mm	200 mm	260 mm	SDS-plus
7858010	...785809	1 hammer drill "Standard"	Ø 14 mm	200 mm	260 mm	SDS-plus
7871010	...787100	1 hammer drill "Standard"	Ø 10 mm	390 mm	450 mm	SDS-plus
7872010	...787209	1 hammer drill "Standard"	Ø 12 mm	400 mm	450 mm	SDS-plus
7874010	...787407	1 hammer drill "Standard"	Ø 14 mm	400 mm	450 mm	SDS-plus
7876010	...787605	1 hammer drill "Standard"	Ø 16 mm	400 mm	450 mm	SDS-plus
7880010	...788008	1 hammer drill "Standard"	Ø 20 mm	400 mm	450 mm	SDS-plus
7885010	...788503	1 hammer drill "Standard"	Ø 25 mm	400 mm	450 mm	SDS-plus
7886010	...788602	1 hammer drill "Standard"	Ø 10 mm	550 mm	600 mm	SDS-plus
7887010	...788701	1 hammer drill "Standard"	Ø 12 mm	550 mm	600 mm	SDS-plus
7888010	...788800	1 hammer drill "Standard"	Ø 14 mm	550 mm	600 mm	SDS-plus
7891010	...789104	1 hammer drill "Standard"	Ø 16 mm	550 mm	600 mm	SDS-plus
7893010	...789302	1 hammer drill "Standard"	Ø 20 mm	550 mm	600 mm	SDS-plus

POWER TOOL ACCESSORIES

6.12 Drills / Chisels

6



article no.	EAN	description	shank	Ø	in	product dimensions
8456000	4006885... ...845602	4 hammer drills "Standard"	SDS-plus	Ø 5 x 110 mm Ø 6 x 110 mm Ø 6 x 160 mm Ø 8 x 160 mm	plastic box	56 x 160 x 18 mm
7113000	...711303	6 hammer drills "Standard"	SDS-plus	Ø 5 x 110 mm Ø 6 x 110 mm Ø 6 x 160 mm Ø 8 x 110 mm Ø 8 x 160 mm Ø 10 x 160 mm	2-component plastic box with lid	112 x 187 x 34 mm
8613000	...861305	6 hammer drills "Standard"	SDS-plus	Ø 5 x 110 mm Ø 6 x 110 mm Ø 8 x 110 mm Ø 6 x 160 mm Ø 8 x 160 mm Ø 10 x 160 mm	2-component plastic box with lid	115 x 190 x 34 mm

TCT-Hammer drills with SDS-max shank



- machine: percussion drills with SDS-max receptacle
- for concrete, granite, brick walls, natural stones, artificial stones
- particularly powerful and robust - even when dealing with armour - thanks to stabilised main cutter
- maximum durability in concrete and armour thanks to larger, rounded auxiliary cutter
- more grip when drilling and no chipping thanks to reinforced two-point centring tip
- effective transmission of the impact energy thanks to optimised tungsten carbide tip angle
- super-fast drilling progress thanks to special spiral
- certified by the Masonry Drill Bit Certification Board (PGM) in accordance with the requirements of the German Institute for Building Technology (DIBt)
- material: TCT
- point angle: 130°
- packaging: plastic clip



article no.	EAN	description	Ø	spiral length	length	shank
5343000	4006885... ...534308	1 hammer drill	Ø 18 mm	400 mm	540 mm	SDS-max
5344000	...534407	1 hammer drill	Ø 20 mm	400 mm	520 mm	SDS-max
5345000	...534506	1 hammer drill	Ø 22 mm	400 mm	520 mm	SDS-max
5346000	...534605	1 hammer drill	Ø 25 mm	400 mm	520 mm	SDS-max
5347000	...534704	1 hammer drill	Ø 28 mm	400 mm	520 mm	SDS-max
5348000	...534803	1 hammer drill	Ø 30 mm	400 mm	520 mm	SDS-max

6.12 Drills / Chisels

Chisels with SDS-plus shank



- content:
1 pointed chisel, 250 mm
1 flat chisel, 250 mm, 20 mm
1 cutting chisel, 250 mm, 35 mm
- packaging: plastic bag on card

article no.	EAN 4006885...	description	shank
7914000	...791404	1 chisel set	SDS-plus



- packaging: plastic bag on card

article no.	EAN 4006885...	description	Cutting width	length	shank
7910000	...791008	1 pointed chisel		250 mm	SDS-plus
7911000	...791107	1 flat chisel	20 mm	250 mm	SDS-plus
7912000	...791206	1 cutting chisel	35 mm	250 mm	SDS-plus
7913000	...791305	1 cutting chisel	22 mm	250 mm	SDS-plus
7909000	...790902	1 tile chisel	40 mm	250 mm	SDS-plus

Chisels with SDS-max shank



- packaging: plastic bag on card

article no.	EAN 4006885...	description	Cutting width	length	shank
5351000	...535107	1 pointed chisel		400 mm	SDS-max
5352000	...535206	1 flat chisel	25 mm	400 mm	SDS-max
5353000	...535305	1 cutting chisel	50 mm	400 mm	SDS-max

POWER TOOL ACCESSORIES 6

6.12 Drills / Chisels

Multi-purpose drills



Multi-purpose drill set

- content:
 - 1 accumobil - mobile drilling aid, for drilling rectangular holes in a speedy and simple way - also for the less experienced craftsman, rubber buffers prevent the drill from running off on smooth surfaces
 - 5 multi-purpose drills, ø 4, 5, 6, 8, 10 mm, precision-ground hard metal plate, wood, stone, metals, plastic materials

article no.	EAN	description	in	product dimensions
1000000	4006885... ...100008	1 multi-purpose drill set	2-component plastic case	165 x 127 x 47 mm



Universal special drill, versatile, durable, long-lasting

- for wood, stone, metals, plastic materials
- precision-ground hard metal plate
- heat-resistant up to 1,100° C
- point angle: 130°
- packaging: plastic bag on card



article no.	EAN	description	Ø	spiral length	length
7962010	4006885... ...796201	1 multi-purpose drill	ø 3 mm	35 mm	70 mm
7963010	...796300	1 multi-purpose drill	ø 4 mm	40 mm	75 mm
7964010	...796409	1 multi-purpose drill	ø 5 mm	50 mm	85 mm
7965010	...796508	1 multi-purpose drill	ø 6 mm	60 mm	100 mm
7967010	...796706	1 multi-purpose drill	ø 8 mm	70 mm	120 mm
7969010	...796904	1 multi-purpose drill	ø 10 mm	70 mm	120 mm



article no.	EAN	description	Ø	in	product dimensions
7114000	4006885... ...711402	6 multi-purpose drills	ø 3, 4, 5, 6, 8, 10 mm	2-component plastic slide-out box	68 x 150 x 18 mm

6.12 Drills / Chisels

Universal drills with SDS-Plus shank



- for stone, wood, metals, plastic materials, composite materials
- meets highest demands
- with diamond-ground TCT minor cutting edge
- optimal drill for renovation work (e.g. for installing windows and doors)
- Caution: Only for rotary use! No hammer drills!
- packaging: plastic clip



article no.	EAN 4006885...	description	Ø	spiral length	length	shank
7436000	...743601	1 universal drill	ø 6 mm	100 mm	160 mm	SDS-plus
7437000	...743700	1 universal drill	ø 8 mm	100 mm	160 mm	SDS-plus
7438000	...743809	1 universal drill	ø 10 mm	100 mm	160 mm	SDS-plus
7439000	...743908	1 universal drill	ø 12 mm	100 mm	160 mm	SDS-plus

Tile and glass drills



- for glass, glass panes, mirrors, bottles, ceramics, porcelain
- exactly ground, lance-shaped carbide plate
- material: TCT
- only for clockwise rotation at low speed and low pressure, to be cooled with water, turpentine or petroleum
- packaging: plastic bag on card



article no.	EAN 4006885...	description	Ø	length
7974010	...797406	1 tile and glass drill	ø 4 mm	90 mm
7975010	...797505	1 tile and glass drill	ø 5 mm	90 mm
7976010	...797604	1 tile and glass drill	ø 6 mm	100 mm
7978010	...797802	1 tile and glass drill	ø 8 mm	100 mm
7979010	...797901	1 tile and glass drill	ø 10 mm	100 mm

POWER TOOL ACCESSORIES 6

6.12 Drills / Chisels

Diamond drills



- machine: power drills
- applicable for attachments for sanitarian equipment and cable bushings
- for tiles, fine stoneware, granite plates, glazed tiles
- sawing edge coated with quality industrial diamonds which even drill through the hardest materials
- main body turned out of solid material - for permanent precision work
- the integrated paraffin facilitates cooling of the cut, which increases the durability and prevents the formation of dust while drilling
- material: diamond coated

article no.	EAN	description	Ø	cutting depth	shank
5990000	4006885...599000	1 diamond drill	Ø 5 mm	30 mm	hexagon shank
5991000	...599109	1 diamond drill	Ø 6 mm	30 mm	hexagon shank
5992000	...599208	1 diamond drill	Ø 8 mm	40 mm	hexagon shank
5993000	...599307	1 diamond drill	Ø 10 mm	40 mm	hexagon shank
5994000	...599406	1 diamond drill	Ø 14 mm	40 mm	hexagon shank

6 POWER TOOL ACCESSORIES

6.12 Drills / Chisels

Drill bit assortments



7115000



7116000



7117000



8615000



8611000

article no.	EAN	description	content	material	in	product dimensions
7115000	4006885...	1 drill combi assortment	5 metal drills ø 3, 4, 5, 6, 8 mm 4 rock drills ø 4, 5, 6, 8 mm	HSS TCT	2-component plastic slide-out box	110 x 150 x 18 mm
7116000	...711600	1 drill combi assortment	5 rock drills ø 3, 4, 5, 6, 8 mm 4 wood drills ø 4, 5, 6, 8 mm	TCT CV	2-component plastic slide-out box	110 x 150 x 18 mm
7117000	...711709	1 drill combi assortment	3 metal drills ø 5, 6, 8 mm 3 rock drills ø 5, 6, 8 mm 3 wood drills ø 5, 6, 8 mm	HSS TCT CV	2-component plastic slide-out box	110 x 150 x 18 mm
8615000	...861503	1 drill combi assortment	8 metal drills ø 1, 2, 3, 4, 5, 6, 7, 8 mm 5 rock drills ø 3, 4, 5, 6, 8 mm 5 wood drills ø 4, 5, 6, 8, 10 mm	HSS TCT CV	2-component plastic box with lid	115 x 190 x 34 mm
8611000	...861107	1 set of drills and bits	6 metal drills ø 2, 3, 4, 5, 6, 8 mm 4 rock drills ø 4, 5, 6, 8 mm 8 bits PH 1/2/3, PZ 1/2/3, SL 0,6x4,5/0,8x5,5 1 bit holder	HSS TCT	plastic box	115 x 190 x 34 mm

POWER TOOL ACCESSORIES 6

6.12 Drills / Chisels

Miscellaneous



- for wood, metals
- material: HSS
- packaging: blister on card

article no.	EAN	description	Ø	spiral length	length	shank
2512000	4006885... ...251205	1 drill saw	Ø 6 mm	60 mm	90 mm	Ø 6 mm



- for milling contours and drilling holes, e.g. for plasterboard dowels
- for plasterboards
- 3 cutting edges with chip breaker grooves ensure fast milling operations
- packaging: blister on card

article no.	EAN	description	Ø	working length	length	shank
7981000	4006885... ...798106	1 drill saw	Ø 8 mm	35 mm	70 mm	Ø 8 mm



- special drill for drilling and contour milling in soft wall tiles
- for enlarging existing dowel holes
- for milling channels for pipes or electrical wiring
- for tiles
- material: tungsten carbide coated
- packaging: blister on card

article no.	EAN	description	Ø	length	shank
7982000	4006885... ...798205	1 drill saw	Ø 6 mm	100 mm	Ø 6 mm

6 POWER TOOL ACCESSORIES

6.12 Drills / Chisels



- for drills \varnothing 4 - 8 mm
- packaging: blister on card

article no.	EAN	description	\varnothing
2900000	4006885... ...290006	1 dust catcher	\varnothing 63 mm



- for marking on stone, sheet metal and steel
- point and impact head inductive hardened
- knurled shank, chromium-coated surface
- packaging: plastic bag on card

article no.	EAN	description	product dimensions
7980010	4006885... ...798007	1 centre punch	8 x 125 mm



- for marking
- for tiles, stone, glass, sheet steel, steel
- carbide tip with soldered conical point
- hexagonal steel
- with carrier clip
- packaging: plastic bag on card

article no.	EAN	description	length
7985010	4006885... ...798502	1 marking tool	150 mm

POWER TOOL ACCESSORIES 6
6.13 Stapler / Staples



6 POWER TOOL ACCESSORIES

6.13 Stapler / Staples

Hand stapler



- solid aluminium pressure die-cast housing ensures heavy duty operation
- with additional impact regulator
- comfortable grip has a special plastic surface for fatigue-free operation
- metal casing
- packaging: sleeve
- separate accessories: 7016000, 7017000, 7026000, 7028000, 7028100, 7031000, 7032000, 7032100, 7036000, 7037000, 7037100, 7042000, 7042100, 7045000, 7046000, 7047000, 7239000



article no.	EAN	description	for
7081000	4006885... ...708105	1 tacocraft M 14+ - hand stapler	for 6 - 14 mm staples type 053 for nails type 062, 16 mm



- solid aluminium pressure die-cast housing ensures heavy duty operation
- comfortable grip has a special plastic surface for fatigue-free operation
- metal casing
- packaging: sleeve
- separate accessories: 7015000, 7016000, 7017000, 7021000, 7026000, 7028000, 7028100, 7031000, 7032000, 7032100, 7036000, 7037000, 7037100

article no.	EAN	description	for
7080000	4006885... ...708006	1 tacocraft M 10 - hand stapler	for 4 - 10 mm staples type 053

POWER TOOL ACCESSORIES 6

6.13 Stapler / Staples



- metal body for high stability
- adjustable impact power
- the hinged magazine allows the fast and easy change of staples
- integrated staple lift
- easy to use
- including: 1000 broad back staples, type 053 - 8 mm
- packaging: double blister
- separate accessories: 7015000, 7016000, 7017000, 7021000, 7026000, 7028000, 7028100, 7031000, 7032000, 7032100, 7036000, 7037000, 7037100, 7042000, 7042100, 7045000, 7046000, 7047000

article no.	EAN	description	for
7089000	4006885... ...708907	1 tacocraft 7 - stapler set	for 4 - 14 mm staples type 053



- metal body for high stability
- adjustable impact power
- the hinged magazine allows the fast and easy change of staples
- easy to use
- including: 1000 broad back staples, type 053 - 8 mm
- packaging: double blister
- separate accessories: 7015000, 7016000, 7017000, 7021000, 7026000, 7028000, 7028100, 7031000, 7032000, 7032100

article no.	EAN	description	for
7088000	4006885... ...708808	1 tacocraft 5 - stapler set	for 4 - 8 mm staples type 053

6 POWER TOOL ACCESSORIES

6.13 Stapler / Staples



- low weight, robust, impact resistant housing
- precision metal staple channel
- comfortable grip has a special plastic surface for fatigue-free operation
- with additional impact regulator
- plastic case
- packaging: sleeve
- separate accessories: 7016000, 7017000, 7026000, 7028000, 7028100, 7031000, 7032000, 7032100, 7036000, 7037000, 7037100, 7042000, 7042100, 7045000, 7046000, 7047000, 7239000

article no.	EAN	description	for
7079000	4006885...707900	1 tacocraft P 14+ - hand stapler	for 6 - 14 mm staples type 053 for nails type 062, 16 mm



- low weight, robust, impact resistant housing
- precision metal staple channel
- comfortable grip has a special plastic surface for fatigue-free operation
- plastic case
- packaging: sleeve
- separate accessories: 7015000, 7016000, 7017000, 7021000, 7026000, 7028000, 7028100, 7031000, 7032000, 7032100, 7036000, 7037000, 7037100

article no.	EAN	description	for
7078000	4006885...707801	1 tacocraft P 10 - hand stapler	for 4 - 10 mm staples type 053



- small but powerful
- plastic case
- packaging: sleeve
- separate accessories: 7016000, 7017000, 7026000, 7028000, 7028100, 7031000, 7032000, 7032100

article no.	EAN	description	for
6999000	4006885...699908	1 tacocraft P 4 - hand stapler	for 6 - 8 mm staples type 053

POWER TOOL ACCESSORIES 6

6.13 Stapler / Staples

Hammer staplers



- designed for continuous, professional use
- ergonomically balanced design for fatigue-free use
- packaging: sleeve
- separate accessories: 7010000, 7011000, 7012000

article no.	EAN	description	for
7000000	...700000	1 tacocraft HT 10 - hammer staplers	for 6 - 10 mm staples type 050



- well-balanced, non-slip handle
- packaging: sleeve
- separate accessories: 7015000, 7016000, 7017000, 7021000, 7026000, 7028000, 7028100, 7031000, 7032000, 7032100

article no.	EAN	description	for
7076000	...707603	1 tacocraft HT 8 - hammer staplers	for 4 - 8 mm staples type 053

Staples / Nails

Typ 013 Broad back staples

suitable for Esco, kwb, LUX, Maestri, Novus, Rapid, Rawlplug, Rexel

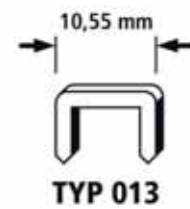

- material: hard steel
- packaging: double blister



article no.	EAN	description	height of staple	type
7056000	...705609	2000 broad back staples	6 mm	013
7057000	...705708	1400 broad back staples	8 mm	013

6.13 Stapler / Staples

Typ 050 Broad back staples

suitable for Arrow, Black & Decker, Bosch, Drapper, Emhard, Esco, Haubold, LUX, Makita, Markwell, Mekano, Novus, Outifrance, Peugeot, Rapid, Rawlplug, Rocafix, RYOBI, Stanley, wolfcraft

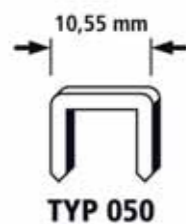

- material: hard steel
- packaging: double blister
- suitable for 7000000



article no.	EAN 4006885...	description	height of staple	type
7010000	...701007	2000 broad back staples	6 mm	050
7011000	...701106	1500 broad back staples	8 mm	050
7012000	...701205	1000 broad back staples	10 mm	050

Typ 053 Broad back staples

suitable for AEG, Arrow, Black & Decker, Bosch, Bukama, Esco, Fischer, Haubold, kwb, LUX, Maestri, Maxicraft, Mekano, Metabo, Neckermann/Bullcraft, Novus, OBI-Brico, Outifrance, Petrus, Piranha, Proxxon, Rapid, Rawlplug, Rexel, Rocafix, Rocagraf, Stanley, wolfcraft

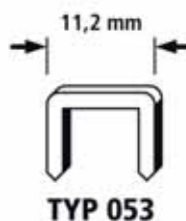

- material: steel
- packaging: double blister



article no.	EAN 4006885...	description	height of staple	type	suitable for
7015000	...701502	3000 broad back staples	4 mm	053	7076000, 7078000, 7080000, 7088000, 7089000
7016000	...701601	4000 broad back staples	6 mm	053	6999000, 7076000, 7078000, 7079000, 7080000, 7081000, 7088000, 7089000
7017000	...701700	3000 broad back staples	8 mm	053	6999000, 7076000, 7078000, 7079000, 7080000, 7081000, 7088000, 7089000

POWER TOOL ACCESSORIES

6.13 Stapler / Staples

6

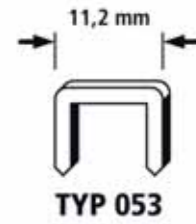

- material: extra hard steel



article no.	EAN	description	height of staple	type	packaging	suitable for
7021000	...702103	2400 broad back staples	4 mm	053	double blister	7076000, 7078000, 7080000, 7088000, 7089000
7026000	...702608	2000 broad back staples	6 mm	053	double blister	6999000, 7076000, 7078000, 7079000, 7080000, 7081000, 7088000, 7089000
7028000	...702806	4000 broad back staples	6 mm	053	double blister	6999000, 7076000, 7078000, 7079000, 7080000, 7081000, 7088000, 7089000
7028100	...702813	5000 broad back staples	6 mm	053	folding box	6999000, 7076000, 7078000, 7079000, 7080000, 7081000, 7088000, 7089000
7031000	...703100	1400 broad back staples	8 mm	053	double blister	6999000, 7076000, 7078000, 7079000, 7080000, 7081000, 7088000, 7089000
7032000	...703209	3000 broad back staples	8 mm	053	double blister	6999000, 7076000, 7078000, 7079000, 7080000, 7081000, 7088000, 7089000
7032100	...703216	5000 broad back staples	8 mm	053	folding box	6999000, 7076000, 7078000, 7079000, 7080000, 7081000, 7088000, 7089000
7036000	...703605	1000 broad back staples	10 mm	053	double blister	7078000, 7079000, 7080000, 7081000, 7089000
7037000	...703704	3000 broad back staples	10 mm	053	double blister	7078000, 7079000, 7080000, 7081000, 7089000
7037100	...703711	4000 broad back staples	10 mm	053	folding box	7078000, 7079000, 7080000, 7081000, 7089000
7042000	...704206	1000 broad back staples	12 mm	053	double blister	7079000, 7081000, 7089000
7042100	...704213	2500 broad back staples	12 mm	053	folding box	7079000, 7081000, 7089000
7046000	...704602	1000 broad back staples	14 mm	053	double blister	7079000, 7081000, 7089000
7047000	...704701	3000 broad back staples	14 mm	053	double blister	7079000, 7081000, 7089000
7049000	...704909	2000 broad back staples	16 mm	053	double blister	

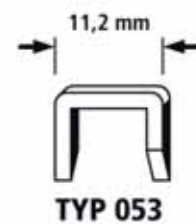

- stainless VA quality steel for exterior use
- material: stainless steel INOX
- packaging: double blister



article no.	EAN	description	height of staple	type
7025000	...702509	2000 broad back staples	6 mm	053
7030000	...703001	1400 broad back staples	8 mm	053

6 POWER TOOL ACCESSORIES

6.13 Stapler / Staples



The staple widens when entering into the material = optimal grip.

- version: D-top
- material: hard steel
- packaging: double blister
- suitable for 7079000, 7081000, 7089000



article no.	EAN	description	height of staple	type
7045000	4006885... ...704503	1000 broad back staples	14 mm	053

Typ 055 Narrow backed staples

suitable for AEG, Black & Decker, Bosch, Bukama, Esco, Holz-Her, kwb, LUX, Metabo, Neckermann/Bullcraft, Novus, Petrus, Rapid, wolfcraft

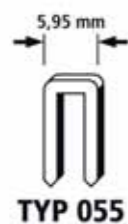

- version: resin coated
- packaging: double blister



article no.	EAN	description	height of staple	type
7166000	4006885... ...716605	1200 narrow backed staples	15 mm	055
7167000	...716704	1200 narrow backed staples	18 mm	055
7169000	...716902	1200 narrow backed staples	23 mm	055
7173000	...717305	1000 narrow backed staples	30 mm	055

Typ 056 Broad back staples

suitable for Arrow, Bostitch, Esco, kwb, LUX, Novus, Rexel, Rocafix, Rocagraf, Skreba, Stanley, Swingline

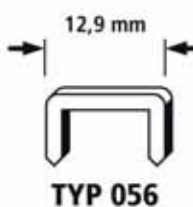

- material: hard steel
- packaging: double blister



article no.	EAN	description	height of staple	type
7177000	4006885... ...717701	1200 broad back staples	8 mm	056

POWER TOOL ACCESSORIES 6

6.13 Stapler / Staples

Typ 057 Broad back staples

suitable for AEG, Casals, LUX, Maxicraft, Mekano, Peugeot, Rocafix, Skil, Swingline



- material: hard steel
- packaging: double blister



article no.	EAN	description	height of staple	type
7192000	4006885... ...719200	1250 broad back staples	8 mm	057

Typ 059 Broad back staples

suitable for Black & Decker, Bukama, wolfcraft

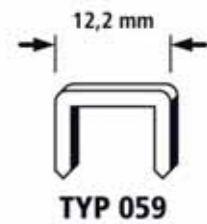

- material: hard steel
- packaging: double blister



article no.	EAN	description	height of staple	type
7203000	4006885... ...720305	1250 broad back staples	8 mm	059

Nails

Typ 062 Nails

suitable for AEG, Black & Decker, Bosch, Casals, Esco, kwb, LUX, Maestri, Maxicraft, Mekano, Metabo, Novus, Rapid, Rocafix, Rocagraf, RYOBI, Skil, Stanley, Swingline, wolfcraft



- material: hard steel
- packaging: double blister



article no.	EAN	description	length	type	suitable for
7234000	4006885... ...723405	1000 nails	14 mm	062	
7239000	...723900	1000 nails	16 mm	062	7079000, 7081000
7241000	...724105	1000 nails	19 mm	062	

6.14 Cutting/ roughing discs



POWER TOOL ACCESSORIES 6
6.14 Cutting/ roughing discs

Cutting/ roughing discs black

Metal cutting discs extra thin



- machine: angle grinders
- no burr formation
- clean cutting edges
- simple, vibration-free cutting
- high cutting performance, long lifetime
- according to EN 12413
- cutting rate: max. 80 m/sec
- packaging: bulk



article no.	EAN	description	Ø	bore	disc thickness	version	for
1685999	...168596	1 fine cutting disc	Ø 115 mm	Ø 22.2 mm	1 mm	straight	Inox
1687999	...168794	1 fine cutting disc	Ø 125 mm	Ø 22.2 mm	1 mm	straight	Inox
1633099	...163300	1 fine cutting disc	Ø 230 mm	Ø 22.2 mm	1.9 mm	straight	Inox
1683999	...168398	1 fine cutting disc	Ø 115 mm	Ø 22.2 mm	1 mm	straight	metals
1684999	...168497	1 fine cutting disc	Ø 125 mm	Ø 22.2 mm	1 mm	straight	metals
1668999	...166899	1 fine cutting disc	Ø 115 mm	Ø 22.2 mm	1.5 mm	straight	aluminium
1669999	...166998	1 fine cutting disc	Ø 125 mm	Ø 22.2 mm	1.5 mm	straight	aluminium



- machine: angle grinders
- no burr formation
- clean cutting edges
- according to EN 12413
- cutting rate: max. 80 m/sec
- packaging: shrinkwrapped with inlay



article no.	EAN	description	Ø	bore	disc thickness	version	for
8460000	...846005	3 cutting discs	Ø 115 mm	Ø 22.2 mm	1.2 mm	straight	Inox
8461000	...846104	3 cutting discs	Ø 125 mm	Ø 22.2 mm	1.2 mm	straight	Inox

6 POWER TOOL ACCESSORIES

6.14 Cutting/ roughing discs

Metal cutting discs



- machine: angle grinders
- for metals
- high cutting performance, long lifetime
- according to EN 12413
- cutting rate: max. 80 m/sec

article no.	EAN 4006885...	description	Ø	bore	disc thickness	version	packaging
1620099	...162099	1 cutting disc	Ø 115 mm	Ø 22.2 mm	2.5 mm	depressed centre	bulk
1620300	...162037	5 cutting discs	Ø 115 mm	Ø 22.2 mm	2.5 mm	depressed centre	shrinkwrapped with inlay
1622099	...162297	1 cutting disc	Ø 125 mm	Ø 22.2 mm	2.5 mm	depressed centre	bulk
1622300	...162235	5 cutting discs	Ø 125 mm	Ø 22.2 mm	2.5 mm	depressed centre	shrinkwrapped with inlay
1624099	...162495	1 cutting disc	Ø 178 mm	Ø 22.2 mm	2.5 mm	straight	bulk
1627099	...162792	1 cutting disc	Ø 230 mm	Ø 22.2 mm	2.5 mm	straight	bulk
1626099	...162693	1 cutting disc	Ø 230 mm	Ø 22.2 mm	3.2 mm	depressed centre	bulk
1626300	...000131	5 cutting discs	Ø 230 mm	Ø 22.2 mm	3.2 mm	depressed centre	shrinkwrapped with inlay

Stone cutting discs



- machine: angle grinders
- for stone
- clean cutting edges
- high cutting performance, long lifetime
- according to EN 12413
- cutting rate: max. 80 m/sec
- packaging: bulk

article no.	EAN 4006885...	description	Ø	bore	disc thickness	version
1686999	...168695	1 fine cutting disc	Ø 115 mm	Ø 22.2 mm	1.6 mm	straight
1688999	...168893	1 fine cutting disc	Ø 125 mm	Ø 22.2 mm	1.6 mm	straight

POWER TOOL ACCESSORIES

6.14 Cutting/ roughing discs

6



- machine: angle grinders
- for stone
- high cutting performance, long lifetime
- according to EN 12413
- cutting rate: max. 80 m/sec

article no.	EAN	description	∅	bore	disc thickness	version	packaging
1621099	4006885...162198	1 cutting disc	∅ 115 mm	∅ 22.2 mm	2.5 mm	depressed centre	bulk
1621300	...162136	5 cutting discs	∅ 115 mm	∅ 22.2 mm	2.5 mm	depressed centre	shrinkwrapped with inlay
1623099	...162396	1 cutting disc	∅ 125 mm	∅ 22.2 mm	2.5 mm	depressed centre	bulk
1623300	...162334	5 cutting discs	∅ 125 mm	∅ 22.2 mm	2.5 mm	depressed centre	shrinkwrapped with inlay
1628099	...162891	1 cutting disc	∅ 230 mm	∅ 22.2 mm	2.5 mm	straight	bulk
1629099	...162990	1 cutting disc	∅ 230 mm	∅ 22.2 mm	2.5 mm	depressed centre	bulk

Universal cutting discs



- machine: angle grinders
- universal for stone and metals
- according to EN 12413
- cutting rate: max. 80 m/sec
- packaging: bulk

article no.	EAN	description	∅	bore	disc thickness	version
1660999	4006885...166097	1 universal cutting disc	∅ 115 mm	∅ 22.2 mm	2.5 mm	depressed centre

Grinding discs



- machine: angle grinders
- for the grinding of welding seams and cast steel
- for metals
- according to EN 12413
- packaging: bulk

article no.	EAN	description	∅	bore	disc thickness	version
1630099	4006885...163096	1 grinding disc	∅ 115 mm	∅ 22.2 mm	6 mm	depressed centre
1631099	...163195	1 grinding disc	∅ 125 mm	∅ 22.2 mm	6 mm	depressed centre

6 POWER TOOL ACCESSORIES

6.14 Cutting/ roughing discs

Assortments



- machine: angle grinders
- packaging: shrinkwrapped with inlay

article no.	EAN 4006885...	description	Ø	bore	content
1663000	...166301	1 Starter set for angle grinder	Ø 115 mm	Ø 22.2 mm	1 fine cutting disc metal, Ø 115 mm 1 cutting disc metal, Ø 115 mm 1 cutting disc stone, Ø 115 mm 1 grinding disc metal, Ø 115 mm 1 lamellar flap disc metal, Ø 115 mm, grain 40
1664000	...166400	1 Starter set for angle grinder	Ø 125 mm	Ø 22.2 mm	1 fine cutting disc metal, Ø 125 mm 1 cutting disc metal, Ø 125 mm 1 cutting disc stone, Ø 125 mm 1 grinding disc metal, Ø 125 mm 1 lamellar flap disc metal, Ø 125 mm, grain 40

Diamond cutting discs "Expert Universal"



- machine: angle grinders
- for reinforced concrete, granite, clinker, natural stone, pumice stone, marble, sand lime bricks, roofing tiles
- comfortable working
- high cutting performance, long lifetime
- very large cutting area
- high degree of safety through production "Made in Germany"
- 100% quality control before delivery
- according to EN 13236
- version: welded, segmented cutting edge
- cutting rate: max. 80 m/sec
- packaging: paperboard card



article no.	EAN 4006885...	description	Ø	bore	height of segment
8372000	...837201	1 diamond cutting disc "Expert Universal"	Ø 115 mm	Ø 22.2 mm	13 mm
8373000	...837300	1 diamond cutting disc "Expert Universal"	Ø 125 mm	Ø 22.2 mm	13 mm
8375000	...837508	1 diamond cutting disc "Expert Universal"	Ø 230 mm	Ø 22.2 mm	17 mm

POWER TOOL ACCESSORIES 6

6.14 Cutting/ roughing discs

Diamond cutting discs "Pro Universal"



- machine: angle grinders
- for pumice stone, washed-out concrete, bricks, concrete, general building materials
- clean, straight cuts
- according to EN 13236
- version: sintered, segmented cutting edge
- cutting rate: max. 80 m/sec
- packaging: paperboard card

article no.	EAN 4006885...	description	Ø	bore	height of segment
8321000	...832107	1 diamond cutting disc "Pro Universal"	Ø 115 mm	Ø 22.2 mm	10 mm
8322000	...832206	1 diamond cutting disc "Pro Universal"	Ø 125 mm	Ø 22.2 mm	10 mm
8323000	...832305	1 diamond cutting disc "Pro Universal"	Ø 180 mm	Ø 22.2 mm	10 mm
8324000	...832404	1 diamond cutting disc "Pro Universal"	Ø 230 mm	Ø 22.2 mm	10 mm

Diamond cutting discs "Pro Ceramic Turbo"



- machine: angle grinders
- for granite, fine stoneware, tiles, ceramic tiles
- finest, fast cuts
- effortless cutting
- very smooth operation and cutting stability
- according to EN 13236
- version: sintered, closed edge with honeycomb structure, super thin (1.4 mm)
- cutting rate: max. 80 m/sec
- reinforced flange for safe use
- packaging: paperboard card

article no.	EAN 4006885...	description	Ø	bore	height of segment
8328000	...832800	1 diamond cutting disc "Pro Ceramic Turbo"	Ø 115 mm	Ø 22.2 mm	10 mm
8329000	...832909	1 diamond cutting disc "Pro Ceramic Turbo"	Ø 125 mm	Ø 22.2 mm	10 mm

6.14 Cutting/ roughing discs

Diamond cutting discs "Pro Ceramic"



- machine: stationary machines
- for granite, fine stoneware, tiles, ceramic tiles
- finest, fast cuts
- effortless cutting
- according to EN 13236
- version: closed cutting edge
- cutting rate: max. 80 m/sec
- packaging: paperboard card

article no.	EAN 4006885...	description	Ø	bore	height of segment
8330000	...833005	1 diamond cutting disc "Pro Ceramic"	Ø 180 mm	Ø 25.4 mm	8 mm
8331000	...833104	1 diamond cutting disc "Pro Ceramic"	Ø 200 mm	Ø 25.4 mm	8 mm

Diamond cutting discs "Pro Turbo"



- machine: angle grinders
- for clinker, roofing tiles, natural stone, bricks
- according to EN 13236
- version: sintered, closed cutting edge
- cutting rate: max. 80 m/sec
- packaging: paperboard card

article no.	EAN 4006885...	description	Ø	bore	height of segment
1694000	...169401	1 diamond cutting disc "Pro Turbo"	Ø 115 mm	Ø 22.2 mm	7 mm
1695000	...169500	1 diamond cutting disc "Pro Turbo"	Ø 125 mm	Ø 22.2 mm	7 mm
1698000	...169807	1 diamond cutting disc "Pro Turbo"	Ø 230 mm	Ø 22.2 mm	7 mm

Diamond cutting discs "Pro Multi"



- machine: angle grinders
- especially for renovation work
- for stone, wood, plastic material, sheet steel, metal tie
- according to EN 13236
- version: allround disc, diamond coated
- cutting rate: max. 80 m/sec
- packaging: paperboard card

article no.	EAN 4006885...	description	Ø	bore
8334000	...833401	1 diamond cutting disc "Pro Multi"	Ø 115 mm	Ø 22.2 mm
8336000	...833609	1 diamond cutting disc "Pro Multi"	Ø 125 mm	Ø 22.2 mm
8335000	...833500	1 diamond cutting disc "Pro Multi"	Ø 230 mm	Ø 22.2 mm

6.14 Cutting/ roughing discs

Diamond cutting discs "Standard Universal"



- machine: angle grinders
- for pumice stone, cobblestones, general building materials
- according to EN 13236
- version: sintered, segmented cutting edge
- cutting rate: max. 80 m/sec
- packaging: paperboard card

article no.	EAN 4006885...	description	∅	bore	height of segment
8385000	...838505	1 diamond cutting disc "Standard Universal"	∅ 110 mm	∅ 22.2 mm	7 mm
8386000	...838604	1 diamond cutting disc "Standard Universal"	∅ 125 mm	∅ 22.2 mm	7 mm
8389000	...838901	1 diamond cutting disc "Standard Universal"	∅ 230 mm	∅ 22.2 mm	7 mm

Diamond cutting discs "Standard Ceramic"



- machine: angle grinders
- for tiles, fine stoneware
- closed cutting edge for clean cuts
- according to EN 13236
- version: sintered, closed cutting edge
- cutting rate: max. 80 m/sec
- packaging: paperboard card

article no.	EAN 4006885...	description	∅	bore	height of segment
8381000	...838109	1 diamond cutting disc "Standard Ceramic"	∅ 110 mm	∅ 22.2 mm	5 mm
8383000	...838307	1 diamond cutting disc "Standard Ceramic"	∅ 180 mm	∅ 22.2 mm	5 mm

Diamond cutting discs "Standard Ceramic"



- machine: stationary machines
- for tiles, fine stoneware
- closed cutting edge for clean cuts
- according to EN 13236
- version: sintered, closed cutting edge
- cutting rate: max. 80 m/sec
- article no. 1651000: 30 mm borehole with reducing ring to 25.4 mm
- packaging: paperboard card

article no.	EAN 4006885...	description	∅	bore	height of segment
1651000	...165106	1 diamond cutting disc "Standard Ceramic"	∅ 180 mm	∅ 25.4 mm	5 mm
8327000	...832701	1 diamond cutting disc "Standard Ceramic"	∅ 230 mm	∅ 25.4 mm	5 mm

6.14 Cutting/ roughing discs

Diamond cup wheel "Standard"



- machine: angle grinders
- for the removal of protrusions
- the aid for renovation work
- for concrete products, pumice stone, bricks, natural stone, artificial stone, mortar residues
- high removal rate for stone grinding
- according to EN 13236
- version: sintered, closed cutting edge
- max. speed 80 m/sec
- packaging: blister on card

article no.	EAN	description	Ø	bore	height of segment
8387000	4006885... ...838703	1 diamond cup wheel "Standard"	Ø 105 mm	Ø 22.2 mm	7 mm
8382000	...838208	1 diamond cup wheel "Standard"	Ø 125 mm	Ø 22.2 mm	7 mm

Assortments



The inexpensive alternative - ideal for all beginners and occasional do-it-yourselfers.

- machine: angle grinders
- for all common applications in the building sector as well as for refurbishing and redecorating jobs
- segmented cutting disc: for cutting bricks, natural stone and quarry tiles
- turbo disc: for all jobs in concrete, reinforced concrete and granite
- tile cutting disc: for clean cuts in marble, tiles and ceramic tiles
- according to EN 13236
- cutting rate: max. 80 m/sec
- content:
 - 1 diamond cutting disc, Ø 110 mm, universal, segmented cutting edge
 - 1 diamond cutting disc, Ø 110 mm, "Turbo"
 - 1 diamond cutting disc, Ø 110 mm, tiles
- packaging: fixed on card

article no.	EAN	description	bore
8392000	4006885... ...839205	1 diamond cutting disc set	Ø 22.2 mm

POWER TOOL ACCESSORIES 6

6.14 Cutting/ roughing discs



The inexpensive alternative - ideal for all beginners and occasional do-it-yourselfers.

- machine: angle grinders
- segmented cutting disc: for cutting bricks, natural stone and quarry tiles
- tile cutting disc: for clean cuts in marble, tiles and ceramic tiles
- according to EN 13236
- cutting rate: max. 80 m/sec
- content:
 - 1 diamond cutting disc, \varnothing 110 mm, segmented cutting edge
 - 1 diamond cutting disc, \varnothing 110 mm, tiles
- packaging: fixed on card

article no.	EAN	description	bore
8390000	4006885... ...839007	1 diamond cutting disc set	\varnothing 22.2 mm

Tungsten carbide cutting discs



- machine: angle grinders
- for wood, laminate, parquet, plastic material
- ideal helper for cutting laminate and parquet, without tearing or discolouring the cutting edge
- version: tungsten carbide coated, segmented cutting edge
- cutting rate: max. 80 m/sec
- quality of cut: fine, clean cuts
- packaging: double blister on card



article no.	EAN	description	\varnothing	bore	disc thickness
8369000	4006885... ...836907	1 tungsten carbide cutting disc "Standard"	\varnothing 115 mm	\varnothing 22.2 mm	1.2 mm
8370000	...837003	1 tungsten carbide cutting disc "Standard"	\varnothing 125 mm	\varnothing 22.2 mm	1.2 mm

6 POWER TOOL ACCESSORIES

6.14 Cutting/ roughing discs

Cutting stands



- machine: one-hand angle grinders \varnothing 115 / 125 mm
- for cutting metal
- integrated clamping device, max. clamping width 100 mm
- robust design with die-cast plate
- packaging: covering box



article no.	EAN	description	product dimensions
5019000	4006885... ...501904	1 cutting stand	190 x 260 x 240 mm



- machine: one- and two-hand angle grinders \varnothing 180 / 230 mm
- for cutting metal
- integrated clamping device, max. clamping width 100 mm
- robust design
- packaging: covering box



article no.	EAN	description	product dimensions
5018000	4006885... ...501805	1 cutting stand	330 x 510 x 350 mm

Accessories



- machine: angle grinders \varnothing 115 / 125 / 230 mm
- thread M 14
- packaging: blister on card

article no.	EAN	description	bore pitch
2456000	4006885... ...245600	1 flange nut	26, 30, 35 mm

POWER TOOL ACCESSORIES

6

6.14 Cutting/ roughing discs



- machine: angle grinders
- version: straight
- packaging: fixed on card

article no.	EAN	description	pin distance	pin diameter
2453000	4006885... ...245303	1 flange key	30 mm	ø 4 mm



- machine: angle grinders
- version: straight
- including: 1 flange nut, M 14
- packaging: fixed on card

article no.	EAN	description	pin distance	pin diameter
2457000	4006885... ...245709	1 flange key	35 mm	ø 5 mm



- machine: angle grinders
- version: depressed centre
- packaging: fixed on card

article no.	EAN	description	pin distance	pin diameter
2458000	4006885... ...245808	1 flange key	35 mm	ø 5 mm



- machine: angle grinders
- variable pin distance
- version: straight
- packaging: fixed on card

article no.	EAN	description	pin distance	pin diameter
2459000	4006885... ...245907	1 universal flange key	30, 35 mm	ø 4 mm

6.15 Health and safety



POWER TOOL ACCESSORIES 6

6.15 Health and safety

Eye protection



The protective goggles for people who wear glasses

- can be comfortably worn over a pair of glasses
- can also be used separately as eye protection
- according to DIN EN 166:2001
- packaging: double blister on card

article no.	EAN	description	version
4901000	4006885... ...490109	1 safety goggles "Standard"	with earpieces, colourless



Saddle-bridge eyeglasses with UV protection

- glass with anti-scratch-coating
- modern and sporty design
- according to DIN EN 166:2001
- packaging: double blister on card

article no.	EAN	description	version
4905000	4006885... ...490505	1 safety goggles "Profi"	with earpieces, toned

6 POWER TOOL ACCESSORIES

6.15 Health and safety



Saddle-bridge eyeglasses for the highest demands

- glass with anti-scratch-coating
- modern and sporty design
- according to DIN EN 166:2001
- packaging: double blister on card



article no.	EAN	description	version
4906000	4006885... ...490604	1 safety goggles "Profi"	with earpieces, colourless



Effective protection against blue light

- integrated light filter protects the retina from harmful blue light
- certified plastic glasses allow unadulterated colour perception
- clip-on frames for adding corrective lenses for optimal vision
- according to DIN EN 166:2001
- packaging: double blister on card



article no.	EAN	description	version
4909000	4006885... ...490901	1 anti-blue light glasses	with earpieces, tinted yellow, with clip-on frame for corrective lenses

POWER TOOL ACCESSORIES 6

6.15 Health and safety



The sporty saddle-bridge glasses

- sporty design for a modern look
- 2-component technology with soft plastic insert for high wearing comfort and all-round protection
- plastic glasses with anti-scratch coating ensure high durability and perfect vision
- with size-adjustable headband for additional grip
- according to DIN EN 166:2001
- packaging: double blister on card

article no.	EAN	description	version
4907000	...490703	1 safety goggles "Sport"	with handle and adjustable rubber strap, colourless



The universal

- the adjustable side pieces allow the goggles to be adjusted to fit any wearer perfectly
- according to DIN EN 166:2001
- packaging: double blister on card

article no.	EAN	description	version
4900000	...490000	1 safety goggles "Safe"	with adjustable earpieces, colourless

6 POWER TOOL ACCESSORIES

6.15 Health and safety



Comprehensive protection under extreme circumstances

- protection against fragments, particles and dust
- the 4 ventilation slots prevent fogging up when working in demanding conditions
- ideal for people who wear glasses
- according to DIN EN 166:2001
- packaging: double blister on card

article no.	EAN	description	version
4902000	...490208	1 full protection goggles "Classic"	with adjustable elastic band, colourless, with valve, 4 ventilating slots



All-round protection

- protection against fragments, particles and dust
- ideal for people who wear glasses
- according to DIN EN 166:2001
- packaging: double blister on card

article no.	EAN	description	version
4903000	...490307	1 full protection goggles "Standard"	with adjustable elastic band, colourless

POWER TOOL ACCESSORIES 6

6.15 Health and safety



Comfortable eyeglasses with ergonomically shaped sealing lip

- for protection against fragments and splashing liquids
- the indirect ventilation slots prevent fogging up when working in highest demanding conditions
- glass with anti-scratch-coating
- ideal for people who wear glasses
- according to DIN EN 166:2001
- packaging: double blister on card

article no.	EAN	description	version
4904000	4006885... ...490406	1 full protection goggles "Comfort"	with adjustable elastic band, colourless, indirect vented



The sturdy safety goggles

- circular glasses and threaded ring in stainless steel look for that special retro look
- high wearing comfort and all-round protection for the eyes thanks to sealing tubular rubber pad
- hidden ventilation slots stop the glasses misting up
- with size-adjustable headband for additional grip
- according to DIN EN 166:2001
- packaging: double blister on card

article no.	EAN	description	version
4908000	4006885... ...490802	1 screw ring glasses	with adjustable elastic band, colourless

6.15 Health and safety

Breathing protection

- **FFP1** masks afford protection against bothersome dust and smoke (solid particles), although the latter do not constitute a direct health hazard. The admissible maximum pollutant concentration is the four-fold MAK* value.
- **FFP2** masks afford protection against solid & liquid particles that are damaging to the health. The admissible maximum pollutant concentration is the 10-fold MAK* value.
- **FFP3** masks protect against toxic, solid & liquid particles as well as particles from carcinogenic and radioactive substances, spores, bacteria, viruses and enzymes. The admissible maximum pollutant concentration is the 30-fold MAK* value.
- **A1P2** filters protect against organic gas and vapour, as released from solvents, lacquers and glue, as well as against solid and liquid particles that are hazardous to health. The admissible maximum pollutant concentration is the 10-fold MAK* value.
- **ABEK** filters protect against organic and inorganic gas and vapour as well as acid gas, ammonia and organic ammonia derivatives. The admissible maximum pollutant concentration is the 30-fold MAK* value.

*The MAK value represents the maximum concentration of a substance in the (breathing) air at the workplace in the form of gas, vapour or suspended particles, which is not considered hazardous to the health, even if one is usually exposed to such concentration 8 hours a day and a maximum of 40 hours a week.



- protection against coarse non-toxic dust, as generated when removing rust, working with filler/cement or on brickwork etc.
- comfortable fit thanks to the mouldable nose piece and soft filter material
- special filter material for easy breathing
- according to DIN EN 149:2001+A1:2009



article no.	EAN	description	filter category	packaging
4831000	4006885... ...483101	3 fine dust masks	FFP1	double blister on card
4832000	...483200	20 fine dust masks	FFP1	covering box

POWER TOOL ACCESSORIES 6

6.15 Health and safety



- protection against low-toxic substances, as generated during wood processing and grinding steel, grinding-off paint or lacquer, working with glass or mineral fibres etc.
- comfortable fit thanks to the mouldable nose piece and soft filter material
- special filter material for easy breathing
- according to DIN EN 149:2001+A1:2009



article no.	EAN	description	filter category	packaging
4836000	4006885... ...483606	3 fine dust masks	FFP2	double blister on card
4837000	...483705	20 fine dust masks	FFP2	covering box



- protection against low-toxic substances, as generated during wood processing and grinding steel, grinding-off paint or lacquer, working with glass or mineral fibres etc.
- with carbon filter against organic odour nuisance
- comfortable fit thanks to the mouldable nose piece and soft filter material
- special filter material and valve for making breathing easier
- according to DIN EN 149:2001+A1:2009
- packaging: double blister on card



article no.	EAN	description	filter category	version
4838000	4006885... ...483804	3 fine dust masks	FFP2 VC	with charcoal filter, with breathing filter

6 POWER TOOL ACCESSORIES

6.15 Health and safety



- protection against low-toxic substances, as generated during wood processing and grinding steel, grinding-off paint or lacquer, working with glass or mineral fibres etc.
- comfortable fit thanks to the mouldable nose piece and soft filter material
- special filter material and valve for making breathing easier
- according to DIN EN 149:2001+A1:2009
- packaging: double blister on card



article no.	EAN	description	filter category	version
4840000	4006885... ...484009	3 fine dust masks	FFP2 V	with breathing filter



- particularly suitable for influenza prevention, such as influenza A/H1N1 swine flu
- protection against toxic substances, generated when grinding stainless steel, when welding aluminium or when working with asbestos
- comfortable fit thanks to the mouldable nose piece and soft filter material
- special filter material and valve for making breathing easier
- with adjustable rubber band to fit each head size
- according to DIN EN 149:2001+A1:2009
- packaging: double blister on card



article no.	EAN	description	filter category	version
4842000	4006885... ...484207	2 fine dust masks	FFP3 V	with breathing filter



- for jobs with coarse, non-hazardous materials (such as polystyrene, lawn cutting, leaf raking etc.)
- Hygienic mask - no personal protective equipment!
- packaging: double blister on card

article no.	EAN	description
4849000	4006885... ...484900	5 hygienic masks

POWER TOOL ACCESSORIES 6

6.15 Health and safety



- protection against gas and vapour, e.g. from solvents, lacquer or adhesives
- good sealing thanks to the variable sealing lip system
- two wide and adjustable elastic band with quick-release fastener will afford the ideal fit for each head size
- according to DIN EN 14387:2004 + A1:2008
- packaging: plastic bag on card
- separate accessories: 4851000, 4852000



article no.	EAN	description	version
4850000	4006885... ...485006	1 half-mask	with replacement filter A1P2



- according to DIN EN 14387:2004 + A1:2008
- suitable for 4850000



article no.	EAN	description	packaging
4851000	4006885... ...485105	1 replacement filter ABEK	double blister on card
4852000	...485204	1 replacement filter A1P2	plastic bag on card

Ear protection

Capsular hearing protectors cover the entire pinna and are suitable if they have to be taken off and put on again frequently. Ear plugs are worn in the auditory canal and are recommended in cases of continuous noise. The single number rating (SNR value) refers to the mean attenuation of the sound level in decibel. The HML value indicate the specific insulation in high, middle and low frequencies.



Lightweight hearing protection for occasional use



- the height of the capsule can be easily adjusted
- according to DIN EN 352-1:2002
- packaging: double blister on card

article no.	EAN	description	SNR value	HML values
4868000	4006885... ...486805	1 ear defenders "Standard"	23 db	H 28 / M 20 / L 12 db

6 POWER TOOL ACCESSORIES

6.15 Health and safety



foldable - space-saving storage

Foldable hearing protection for permanent using in loud surroundings



- size adjustable
- according to DIN EN 352-1:2002
- packaging: double blister on card

article no.	EAN	description	SNR value	HML values
4865000	4006885... ...486508	1 ear defenders "Compact"	26 db	H 30 / M 23 / L 15 db



Professional hearing protection for using in extremely loud surroundings



- for working with a plate vibrator, a compressor or similar equipment
- the ergonomically shaped and stable headband provides highest comfort, even when worn over long hours
- size adjustable
- foldable - space-saving storage
- according to DIN EN 352-1:2002
- packaging: double blister on card

article no.	EAN	description	SNR value	HML values
4870000	4006885... ...487000	1 ear defenders "Profi"	30 db	H 31 / M 28 / L 19 db



Comfortable reusable plugs



- fins seal the ear passage, without exerting uncomfortable pressure
- according to DIN EN 352-2:2002
- material: soft, thermoplastic material
- packaging: double blister on card

article no.	EAN	description	SNR value	HML values
4866000	4006885... ...486607	1 pair of ear plugs	20 db	H 21 / M 16 / L 15 db

POWER TOOL ACCESSORIES 6

6.15 Health and safety



Comfortable reusable plugs with cord

- fins seal the ear passage, without exerting uncomfortable pressure
- with cord, for jobs with many interruptions
- according to DIN EN 352-2:2002
- material: soft, thermoplastic material
- packaging: double blister on card



article no.	EAN	description	SNR value	HML values
4872000	4006885... ...487208	1 pair of ear plugs	20 db	H 21 / M 16 / L 15 db



The inexpensive disposable ear plugs

- for extreme noisy conditions
- easily formed to fit perfectly into the ear passage
- according to DIN EN 352-2:2002
- packaging: double blister on card



article no.	EAN	description	SNR value	HML values
4874000	4006885... ...487406	4 pairs of ear plugs one-way	30 db	H 31 / M 27 / L 21 db

6.15 Health and safety

Head protection



- impact energy absorbing shape
- universal case for hearing protectors
- with drip rail
- roughened top area minimizes scratches
- easy size adjustment
- according to DIN EN 397:2012 + A1:2012
- packaging: sticker



article no.	EAN	description	colour
4853000	4006885... ...485303	1 protective helmet	yellow
4855000	...485501	1 protective helmet	white



Sporty baseball-style cap with shell inside as a means of impact protection

- to protect the head against bumps and abrasion on objects, equipments, wood, stone etc.
- for fields of application, where the legislator does not stipulate the use of a protective helmet pursuant to DIN EN 397, such as for gardening or for the interior finishing of houses
- according to DIN EN 812:2012
- packaging: sticker



article no.	EAN	description	colour
4858000	4006885... ...485808	1 cap	black

POWER TOOL ACCESSORIES 6

6.15 Health and safety

Body protection



Universal disposable overall with hood

- protects against dust and dirt
- breathable
- with elastic band in the hood for optimal adjustment
- elastic band at the waistline, and at the end of arms and legs
- with zip cover
- packaging: plastic bag with inlay

article no.	EAN	description	size	colour
4890000	4006885... ...489004	1 disposable overall	XL	white



- can be used to prevent footprints from dirty and dusty shoes
- for laying laminate, tiles, carpets etc.
- length ca. 40 cm
- packaging: plastic bag on card

article no.	EAN	description	colour
4877000	4006885... ...487703	2 pairs of shoe covers	white

Assortments



- content:
 - 1 full protection goggles, DIN EN 166:2001
 - 1 fine dust mask, FFP1, DIN EN 149:2001+A1:2009
 - 1 ear defenders, DIN EN 352-1:2002
- packaging: plastic bag on card



article no.	EAN	description
4871000	4006885... ...487109	1 work safety kit

6.16 Accessories for vibration saws

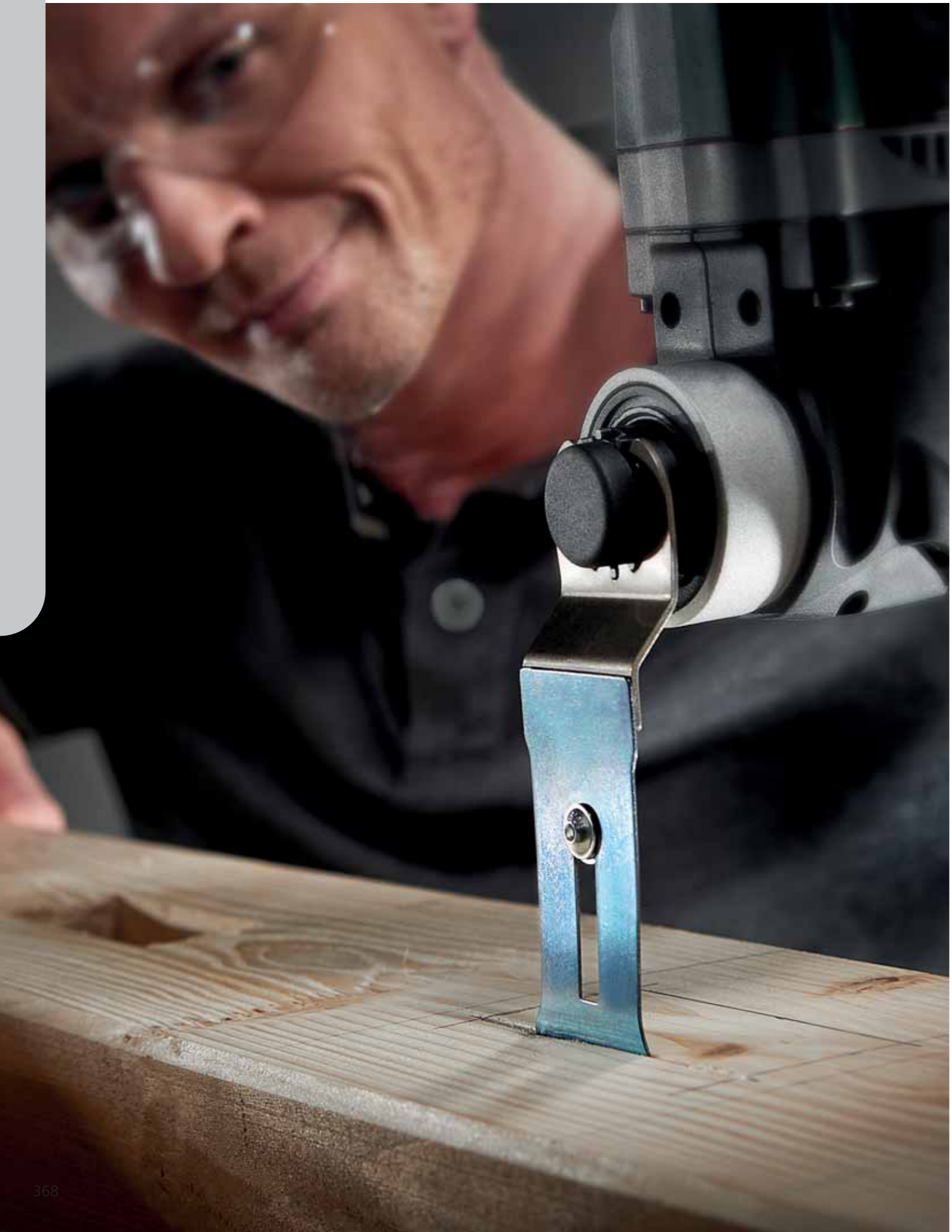

6.16 Accessories for vibration saws

Universal receptacle

suitable for AEG, Batavia, Black & Decker, Bosch (no STARLOCK receptacle), CAPAZ, CRAFTSMAN, DeWalt, DEXTER, DREMEL, Einhell, Erbauer, Fein (no STARLOCK receptacle), Greenworks, Hitachi, Kraft Werkzeuge, KRAFTRONIC, LUX, Mac Allister, Makita, Mastercraft, Metabo, Milwaukee, Parkside, Passat, PorterCable, Renovator, Rockwell, RYOBI, Scheppach, Skil, Stanley, Titan, Westfalia, Worx

for wood/plastic working



- perfect capabilities at assembled parts
- high cutting speed
- for soft wood, chipboards, laminate, parquet, plastic material
- blued blade for reduced cutting resistance
- material: HCS
- including: 1 adapter ring for Bosch PMF 250 CES
- packaging: double blister

article no.	EAN	description	cutting width	blade shape
3988000	...398801	1 pushcut saw blade "PRO"	10 mm	straight
3989000	...398900	1 pushcut saw blade "PRO"	22 mm	straight
3990000	...399006	1 pushcut saw blade "PRO"	28 mm	straight

6 POWER TOOL ACCESSORIES

6.16 Accessories for vibration saws



- for clean cuts in wood with a controlled insertion depth
- ideal for mortise and tenon joints or cable slots in timber frames
- ideal for flat materials (e.g. laminate, parquet, transition strips, etc.)
- for soft wood, chipboards, coated boards, laminate
- centred insertion and controlled break-through without damaging the surface thanks to convex shape
- clean cutting edges with no ragged edges
- perfect control of the cutting depth
- improved chip removal
- stainless steel receptacle for better force transmission
- blued blade for reduced cutting resistance
- material: HCS
- tooth form: straight-set
- tooth distance: 1,93 mm
- tooth version: pointed teeth
- including:
 - 1 depth stop, removable
 - 1 adapter ring for Bosch PMF 250 CES
- packaging: double blister

article no.	EAN	description	cutting width	blade shape	miscellaneous
3835000	...383500	1 pushcut saw blade with depth stop "PRO"	28 mm	convex	max. cutting depth: with depth stop = 30 mm, without depth stop = 55 mm
3836000	...383609	1 pushcut saw blade with depth stop "PRO"	35 mm	convex	max. cutting depth: with depth stop = 30 mm, without depth stop = 55 mm
3837000	...383708	1 pushcut saw blade with depth stop "PRO"	45 mm	convex	max. cutting depth: with depth stop = 28 mm, without depth stop = 55 mm longitudinal cuts
3838000	...383807	1 pushcut saw blade with depth stop "PRO"	65 mm	convex	max. cutting depth: with depth stop = 28 mm, without depth stop = 45 mm longitudinal cuts

6.16 Accessories for vibration saws



- for cutting round materials, e.g. plastic pipes, close to walls
- for plastic material, hardwood
- steady, precise cutting behaviour thanks to concave blade
- minimises the risk of damage to the wall
- stainless steel receptacle for better force transmission
- blued blade for reduced cutting resistance
- material: HCS
- tooth form: straight-set
- tooth distance: 1,88 mm
- tooth version: pointed teeth
- including: 1 adapter ring for Bosch PMF 250 CES
- packaging: double blister



article no.	EAN	description	cutting depth	cutting width	blade shape
3964000	...396401	1 pipe cutter "PRO"	48 mm	32 mm	concave
3965000	...396500	1 pipe cutter "PRO"	51 mm	55 mm	concave



- universally use for longitudinal and curved cuts
- for cut-outs in floor units in the bathroom and kitchen for installing drain pipes
- for circular cuts in materials with thicknesses of up to 25 mm
- for laminate, parquet
- unique geometry permits circular cut-outs
- clean longitudinal cuts thanks to fully toothed blade
- blued blade for reduced cutting resistance
- material: HCS
- tooth form: precision ground
- tooth distance: 1,4 mm
- tooth version: pointed teeth
- including: 1 adapter ring for Bosch PMF 250 CES
- packaging: double blister



article no.	EAN	description	cutting width
3975000	...397507	1 curved saw blade "PRO"	78 mm

6 POWER TOOL ACCESSORIES

6.16 Accessories for vibration saws

for use on wood/plastic/metal



- perfect for construction, renovation and repair work
- for wood with nails, multiplex boards, non-ferrous metals, plasterboards
- stainless steel receptacle for better force transmission
- blued blade for reduced cutting resistance
- material: BiM
- including: 1 adapter ring for Bosch PMF 250 CES
- packaging: double blister

article no.	EAN 4006885...	description	cutting width	blade shape	miscellaneous
3986000	...398603	1 pushcut saw blade "PRO"	10 mm	straight	
3987000	...398702	1 pushcut saw blade "PRO"	22 mm	straight	
3952000	...395206	1 pushcut saw blade "PRO"	65 mm	straight	longitudinal cuts



- for clean cuts through hard materials with a controlled insertion depth
- ideal for flat materials (e.g. laminate, parquet, transition strips, etc.)
- for coated boards, non-ferrous metals
- sturdy, long-life blade
- perfect control of the cutting depth
- improved chip removal
- stainless steel receptacle for better force transmission
- blued blade for reduced cutting resistance
- material: BiM
- tooth form: straight-set and milled
- tooth distance: 1,4 mm
- tooth version: negative toothing
- including:
 - 1 depth stop, removable
 - 1 adapter ring for Bosch PMF 250 CES
- packaging: double blister

article no.	EAN 4006885...	description	cutting width	blade shape	miscellaneous
3839000	...383906	1 pushcut saw blade with depth stop "PRO"	28 mm	straight	max. cutting depth: with depth stop = 30 mm, without depth stop = 55 mm
3840000	...384002	1 pushcut saw blade with depth stop "PRO"	35 mm	straight	max. cutting depth: with depth stop = 30 mm, without depth stop = 55 mm



6.16 Accessories for vibration saws



article no.	EAN 4006885...	description	cutting width	blade shape	miscellaneous
3841000	...384101	1 pushcut saw blade with depth stop "PRO"	45 mm	straight	max. cutting depth: with depth stop = 28 mm, without depth stop = 55 mm longitudinal cuts
3842000	...384200	1 pushcut saw blade with depth stop "PRO"	65 mm	straight	max. cutting depth: with depth stop = 28 mm, without depth stop = 45 mm longitudinal cuts



- for cutting round materials, e.g. copper pipes, close to walls
- for non-ferrous metals, aluminium, nails
- steady, precise cutting behaviour thanks to concave blade
- minimises the risk of damage to the wall
- stainless steel receptacle for better force transmission
- blued blade for reduced cutting resistance
- material: BiM
- tooth form: straight-set
- tooth distance: 1,4 mm
- tooth version: pointed teeth
- including: 1 adapter ring for Bosch PMF 250 CES
- packaging: double blister

article no.	EAN 4006885...	description	cutting depth	cutting width	blade shape
3848000	...384804	1 pipe cutter "PRO"	49 mm	32 mm	concave
3849000	...384903	1 pipe cutter "PRO"	49 mm	55 mm	concave

6 POWER TOOL ACCESSORIES

6.16 Accessories for vibration saws



- cranked saw blades allow the usage near surface
- segmentation allows cuts in a right angle without any overcut
- for easy removing of mastic without any danger of broken glas
- for laminate, parquet, non-ferrous metals, tubes
- material: BiM
- including: 1 adapter ring for Bosch PMF 250 CES
- packaging: double blister



article no.	EAN	description	∅
3999000	...399907	1 radial saw blade "PRO"	∅ 85 mm

for use with cement joints and mortar residues



- especially for plunge cuts for removing joint mortar
- for aerated concrete, cement joints, mortar residues
- high durability
- material: diamond coated
- including: 1 adapter ring for Bosch PMF 250 CES
- packaging: double blister

article no.	EAN	description	product dimensions
3950000	...395008	1 hatchet saw "PRO"	58 mm

6.16 Accessories for vibration saws



- segmentation allows cuts in a right angle without any overcut
- cranked saw blades allow the usage near surface
- for removing joint mortar
- for aerated concrete, mortar residues, cement joints
- high durability
- material: diamond coated
- including: 1 adapter ring for Bosch PMF 250 CES
- packaging: double blister

article no.	EAN	description	∅
3997000	4006885... ...399709	1 radial saw blade "PRO"	∅ 85 mm



- especially for long cuts in cement joints
- for aerated concrete, cement joints, mortar residues
- high durability
- material: diamond coated
- including: 1 adapter ring for Bosch PMF 250 CES
- packaging: double blister

article no.	EAN	description	∅	version
3955000	4006885... ...395503	1 saw blade "PRO"	∅ 80 mm	depressed centre



- segmentation allows cuts in a right angle without any overcut
- cranked saw blades allow the usage near surface
- for removing joint mortar
- for aerated concrete, cement joints, mortar residues
- material: tungsten carbide coated
- including: 1 adapter ring for Bosch PMF 250 CES
- packaging: double blister

article no.	EAN	description	∅
3995000	4006885... ...399501	1 radial saw blade "PRO"	∅ 85 mm

6 POWER TOOL ACCESSORIES

6.16 Accessories for vibration saws



- especially for tile repair work
- 2 in 1 - universal tool for cutting and grinding grout residues and cement joints
- for mortar residues, aerated concrete, cement joints
- material: tungsten carbide coated
- grinding surface 88 mm long
- including: 1 adapter ring for Bosch PMF 250 CES
- packaging: double blister

article no.	EAN	description	Ø	version	product dimensions
3954000	4006885... ...395404	1 grinding cutter "PRO"	ø 65 mm	depressed centre	65 x 88 mm



- ideal for working in small, enclosed spaces
- for grinding grout residues
- material: tungsten carbide coated
- including: 1 adapter ring for Bosch PMF 250 CES
- packaging: double blister

article no.	EAN	description	version	product dimensions
3951000	4006885... ...395107	1 finger rasp "PRO"	triangular	35 mm



- for perfect results in renovated buildings or facades
- surface grinding of tile adhesive droppings
- removing of graffiti at concrete and stone facades
- removing of oil stain on concrete or garage floors
- rough sanding of wood
- for concrete, plaster, stone, cement, tile cement, wood, varnish
- material: tungsten carbide coated
- including: 1 adapter ring for Bosch PMF 250 CES
- packaging: double blister

article no.	EAN	description	version	corner measurement
3994000	4006885... ...399402	1 sanding plate "PRO"	triangular	80 mm

6.16 Accessories for vibration saws

for use with soft materials



- perfect for use in corners and places that are difficult to access
- for scraping off silicone and adhesive residues
- material: HCS
- including: 1 adapter ring for Bosch PMF 250 CES
- packaging: double blister

article no.	EAN	description	product dimensions
3953000	4006885... ...395305	1 finger scraper "PRO"	10 x 45 mm



- for removing of mortar droppings, carpet or tile adhesive, cinder, protective undercoating, damaged coatings
- material: HCS
- including: 1 adapter ring for Bosch PMF 250 CES
- packaging: double blister

article no.	EAN	description	version	product dimensions
3991000	4006885... ...399105	1 scraper "PRO"	steep type	52 mm



- for removing glue residue, stickers, elastic sealants in the kitchen or bathroom
- material: HCS
- including: 1 adapter ring for Bosch PMF 250 CES
- packaging: double blister

article no.	EAN	description	version	product dimensions
3998000	4006885... ...399808	1 scraper "PRO"	flexible	52 mm

6 POWER TOOL ACCESSORIES

6.16 Accessories for vibration saws



- safe, controlled cutting of vinyl
- ergonomic hook shape
- the safe alternative to cutting using the cutter
- material: HCS
- including: 1 adapter ring for Bosch PMF 250 CES
- packaging: double blister



article no.	EAN	description
3864000	4006885... ...386402	1 drawknife "PRO"



- safe, controlled cutting of laid vinyl close to walls
- for creating an expansion joint in laid material
- fitting and cutting vinyl floorings right into the corners
- the safe alternative to cutting using the cutter
- material: HCS
- including: 1 adapter ring for Bosch PMF 250 CES
- packaging: double blister



article no.	EAN	description
3865000	4006885... ...386501	1 impact blade "PRO"

Miscellaneous



- for easy-fix sanding sheets 95 mm
- with easy-fix fibre for a fast change of the sanding paper
- including: 1 adapter ring for Bosch PMF 250 CES
- packaging: double blister
- separate accessories: 5885000, 5886000

article no.	EAN	description	version	corner measurement
3996000	4006885... ...399600	1 adhesive sanding plate "PRO"	triangular	95 mm

6.16 Accessories for vibration saws



- allows all wolcraft vibration saw tools to be used on machines from WORX old, ROCKWELL and CAPAZ
- packaging: blister on card

article no.	EAN	description
3985000	4006885... ...398504	1 adapter for vibration saws

Assortments



- for wood, metal, plastic material
- content:
 - 1 radial saw blade, BiM, ø 85 mm
 - 1 pushcut saw blade, BiM, 22 mm
 - 1 pushcut saw blade, HCS, 22 mm
 - 1 adapter ring for Bosch PMF 250 CES
- packaging: sliding blister

article no.	EAN	description
3992000	4006885... ...399204	1 accessory set "PRO"



- for cement joints, mortar residues
- content:
 - 1 radial saw blade, tungsten carbide coated, ø 65 mm
 - 1 sanding plate, tungsten carbide coated, triangular, 80 mm
 - 1 adapter ring for Bosch PMF 250 CES
- packaging: sliding blister

article no.	EAN	description
3993000	4006885... ...399303	1 accessory set "PRO"



- for laminate, parquet, skirting boards and crown mouldings
- content:
 - 1 pushcut saw blade, HCS, 10 mm
 - 1 pushcut saw blade, HCS, 22 mm
 - 1 pushcut saw blade, HCS, 65 mm
 - 1 radial saw blade, BiM, ø 85 mm
 - 1 adapter ring for Bosch PMF 250 CES
- in 2-component plastic box with lid
- packaging: plastic box

article no.	EAN	description
3961000	4006885... ...396104	1 vibration saw starter set for laminate "PRO"

6 POWER TOOL ACCESSORIES

6.16 Accessories for vibration saws



- especially for renovation work
- content:
 - 1 pushcut saw blade, BiM, 22 mm
 - 1 pushcut saw blade, BiM, 65 mm
 - 1 scraper, HCS, steep type, 52 mm
 - 1 finger scraper, 45 x 10 mm
 - 1 grinding cutter, tungsten carbide coated, ø 65 mm
 - 1 adapter ring for Bosch PMF 250 CES
- in 2-component plastic box with lid
- packaging: plastic box

article no.	EAN	description
3962000	4006885... ...396203	1 vibration saw starter set "PRO"



- for wood, gypsum plaster boards
- content:
 - 1 pushcut saw blade, HCS, 28 mm
 - 1 pushcut saw blade, HCS, 44 mm
 - 1 pushcut saw blade, HCS, 65 mm
 - 1 adapter ring for Bosch PMF 250 CES
- packaging: blister on card

article no.	EAN	description
8490000	4006885... ...849006	1 vibration saw set for drywall installation "Standard"



- for cement joints, mortar residues, silicone, adhesive
- content:
 - 1 radial saw blade, tungsten carbide coated, ø 65 mm
 - 1 scraper, HCS, 52 mm
 - 1 finger scraper, HCS, 10 mm
 - 1 adapter ring for Bosch PMF 250 CES
- packaging: blister on card

article no.	EAN	description
8491000	4006885... ...849105	1 vibration saw set for joint repairs "Standard"

6.16 Accessories for vibration saws

STARLOCK receptacle

suitable for Bosch, Fein

for wood/plastic working



- For cutting small recesses in soft wood and laminate
- for soft wood, chipboards, laminate, parquet
- material: HCS
- tooth form: straight-set
- tooth distance: 1,3 mm
- tooth version: pointed teeth
- packaging: double blister

article no.	EAN	description	cutting depth	cutting width	blade shape
3935000	...393509	1 pushcut saw blade "Expert"	37 mm	24 mm	straight



For cutting small recesses in soft wood and laminate

- for wood, chipboards, laminate, parquet, plastic material
- powerful and durable
- material: HCS
- tooth form: straight-set
- tooth distance: 1,4 mm
- tooth version: pointed teeth
- packaging: double blister



article no.	EAN	description	cutting depth	cutting width	blade shape
4238000	...423800	1 pushcut saw blade "Expert"	42 mm	35 mm	straight

6 POWER TOOL ACCESSORIES

6.16 Accessories for vibration saws



- for precise, fine cuts in wood
- Suitable for plunge cuts and longitudinal cuts as well as cutting to length
- for soft wood, hardwood, laminate, parquet
- blued blade for reduced cutting resistance
- material: BiM
- tooth distance: 1,8 mm
- tooth version: Japan toothing
- packaging: double blister

article no.	EAN	description	cutting depth	cutting width	blade shape
3937000	4006885... ...393707	1 pushcut saw blade "Expert"	48 mm	32 mm	convex



- Suitable for plunge cuts and longitudinal cuts as well as cutting to length
- for wood, laminate, parquet, plastic coated chipboards, plastic material
 - powerful and durable
 - material: BiM
 - tooth distance: 1,75 mm
 - tooth version: Japan toothing
 - packaging: double blister



article no.	EAN	description	cutting depth	cutting width	blade shape
4239000	4006885... ...423909	1 pushcut saw blade "Expert"	42 mm	35 mm	straight

6.16 Accessories for vibration saws



- for precise, fine cuts in wood
- Suitable for plunge cuts and longitudinal cuts as well as cutting to length
- for soft wood, hardwood, laminate, parquet
- blued blade for reduced cutting resistance
- material: HCS
- tooth form: straight-set
- tooth distance: 1,3 mm
- packaging: double blister

article no.	EAN	description	cutting depth	cutting width	blade shape
3936000	4006885... ...393608	1 pushcut saw blade "Expert"	39 mm	65 mm	convex

for use on wood/plastic/metal



- suitable for plunge cuts and cutting to length
- for wood with nails, multiplex boards, non-ferrous metals
- blued blade for reduced cutting resistance
- material: BiM
- tooth form: straight-set
- tooth distance: 1,3 mm
- tooth version: pointed teeth
- packaging: double blister

article no.	EAN	description	cutting depth	cutting width	blade shape
3938000	4006885... ...393806	1 pushcut saw blade "Expert"	48 mm	32 mm	convex
3939000	...393905	1 pushcut saw blade "Expert"	39 mm	65 mm	convex

6 POWER TOOL ACCESSORIES

6.16 Accessories for vibration saws



- for cutting recesses in aluminium baseboards and furniture elements
- suitable for plunge cuts and cutting to length
- for non-ferrous metals, plasterboards
- material: BiM
- tooth distance: 1,3 mm
- tooth version: pointed teeth
- packaging: double blister

article no.	EAN	description	cutting depth	cutting width	blade shape
3940000	...394001	1 pushcut saw blade "Expert"	33 mm	20 mm	straight
3941000	...394100	1 pushcut saw blade "Expert"	48 mm	32 mm	straight



Suitable for plunge cuts and longitudinal cuts as well as cutting to length

- for wood, wood with nails, non-ferrous metals, plasterboards, plastic material
- powerful and durable
- material: BiM
- tooth distance: 1,4 mm
- tooth version: pointed teeth
- packaging: double blister



article no.	EAN	description	cutting depth	cutting width	blade shape
4240000	...424005	1 pushcut saw blade "Expert"	42 mm	10 mm	straight
4243000	...424302	1 pushcut saw blade "Expert"	42 mm	50 mm	straight

6.16 Accessories for vibration saws



- Suitable for plunge cuts and longitudinal cuts as well as cutting to length
- for wood, wood with nails, non-ferrous metals, plasterboards, plastic material
 - powerful and durable
 - material: BiM
 - tooth form: form-ground and milled
 - tooth distance: 1,4 mm
 - tooth version: pointed teeth
 - packaging: double blister

article no.	EAN	description	cutting depth	cutting width	blade shape
4241000	...424104	1 pushcut saw blade "Expert"	47 mm	28 mm	straight
4242000	...424203	1 pushcut saw blade "Expert"	47 mm	44 mm	straight



- Ideal for cutting out old windows
- for cutting pipes and transition strips
- for longitudinal cuts
- for soft wood, hardwood, veneered boards, plastic coated chipboards, non-ferrous metals
- blued blade for reduced cutting resistance
- material: BiM
- tooth distance: 1,4 mm
- tooth version: pointed teeth
- packaging: double blister

article no.	EAN	description	Ø	cutting depth	version
3943000	...394308	1 radial saw blade "Expert"	Ø 85 mm	20 mm	depressed centre

6 POWER TOOL ACCESSORIES

6.16 Accessories for vibration saws



Ideal for cutting out old windows

- segmented cutting edge, ideal for working in corners and on edges without overcut
- cutting out old windows, removal of mastic from glazing, cuts at right angles without overcut, longitudinal cuts, cutting to length
- for wood, plasterboards, plastic material, non-ferrous metals
- powerful and durable
- material: HSS
- tooth distance: 1,4 mm
- tooth version: pointed teeth
- packaging: double blister



article no.	EAN	description	∅	cutting depth	version
4244000	...424401	1 radial saw blade "Expert"	∅ 85 mm	20 mm	depressed centre

for metal working



- tungsten carbide blade for cutting the hardest metals
- for capping screws
- suitable for plunge cuts and cutting to length
- for aluminium, stainless steel
- blued blade for reduced cutting resistance
- powerful and durable
- material: tungsten carbide tipped
- tooth distance: 1,1 mm
- packaging: double blister

article no.	EAN	description	cutting depth	cutting width	blade shape
3942000	...394209	1 pushcut saw blade "Expert"	38 mm	20 mm	straight

6.16 Accessories for vibration saws

for use with cement joints and mortar residues



- for removing joint mortar
- for mortar, cement joints
- material: tungsten carbide coated
- packaging: double blister

article no.	EAN	description	Ø	cutting depth	version
3929000	4006885... ...392908	1 radial saw blade "Expert"	Ø 85 mm	20 mm	depressed centre



For removing damaged tile joints

- segmented cutting edge, ideal for working in corners and on edges without overcut
- for mortar, cement joints, aerated concrete
- powerful and durable
- material: tungsten carbide coated
- packaging: double blister

article no.	EAN	description	Ø	cutting depth	version
4245000	4006885... ...424500	1 radial saw blade "Expert"	Ø 75 mm	20 mm	depressed centre



- The helper for tile renovations
- for removing all traces of tile cement or other hard materials
- for coarse sanding work on wood
- for mortar, tile cement
- material: tungsten carbide coated
- packaging: double blister

article no.	EAN	description	cutting depth	version	corner measurement
3930000	4006885... ...393004	1 sanding plate "Expert"	22 mm	triangular	80 mm

6 POWER TOOL ACCESSORIES

6.16 Accessories for vibration saws



The helper for tile renovations

- for removing all traces of tile cement or other hard materials
- for coarse sanding work on wood
- ideal for working in inaccessible places
- for Facades, concrete, stone, mortar residues, tile cement, filler material, wood
- powerful and durable
- material: tungsten carbide coated
- packaging: double blister



article no.	EAN	description	cutting depth	version	corner measurement
4246000	...424609	1 sanding plate "Expert"	29 mm	triangular	80 mm

for use with soft materials



- for removing silicone joints and adhesive residues
- perfect for use in corners and places that are difficult to access
- for silicone, adhesive
- material: HCS
- packaging: double blister

article no.	EAN	description	product dimensions
3983000	...398306	1 finger scraper "Expert"	7 x 45 mm



- For removing/scraping rubber substances, e.g. carpet glue
- for mortar, carpet glue
- material: HCS
- packaging: double blister

article no.	EAN	description	product dimensions
3982000	...398207	1 scraper "Expert"	52 mm

6.16 Accessories for vibration saws



For removing/scraping rubber substances, e.g. carpet glue For removing hard material residues and coatings

- for carpet and tile adhesive residues, protective undercoating, carpet, old paint
- powerful and durable
- short version for greater control when working
- material: HCS
- packaging: double blister

article no.	EAN	description	product dimensions
4249000	4006885... ...424906	1 scraper "Expert"	52 mm

Miscellaneous



- for easy-fix sanding sheets 95 mm
- Ideal for sanding in corners and niches
- with easy-fix fibre for a fast change of the sanding paper
- packaging: double blister
- separate accessories: 5885000, 5886000

article no.	EAN	description	version	corner measurement
3944000	4006885... ...394407	1 adhesive sanding plate "Expert"	triangular	95 mm



Ideal for sanding in corners and niches

- for easy-fix sanding sheets 95 mm
- with easy-fix fibre for a fast change of the sanding paper
- powerful and durable
- Swiss Made
- packaging: double blister
- separate accessories: 5885000, 5886000

article no.	EAN	description	version	corner measurement
4247000	4006885... ...424708	1 adhesive sanding plate "Expert"	triangular	95 mm

7.1 Cutting tools

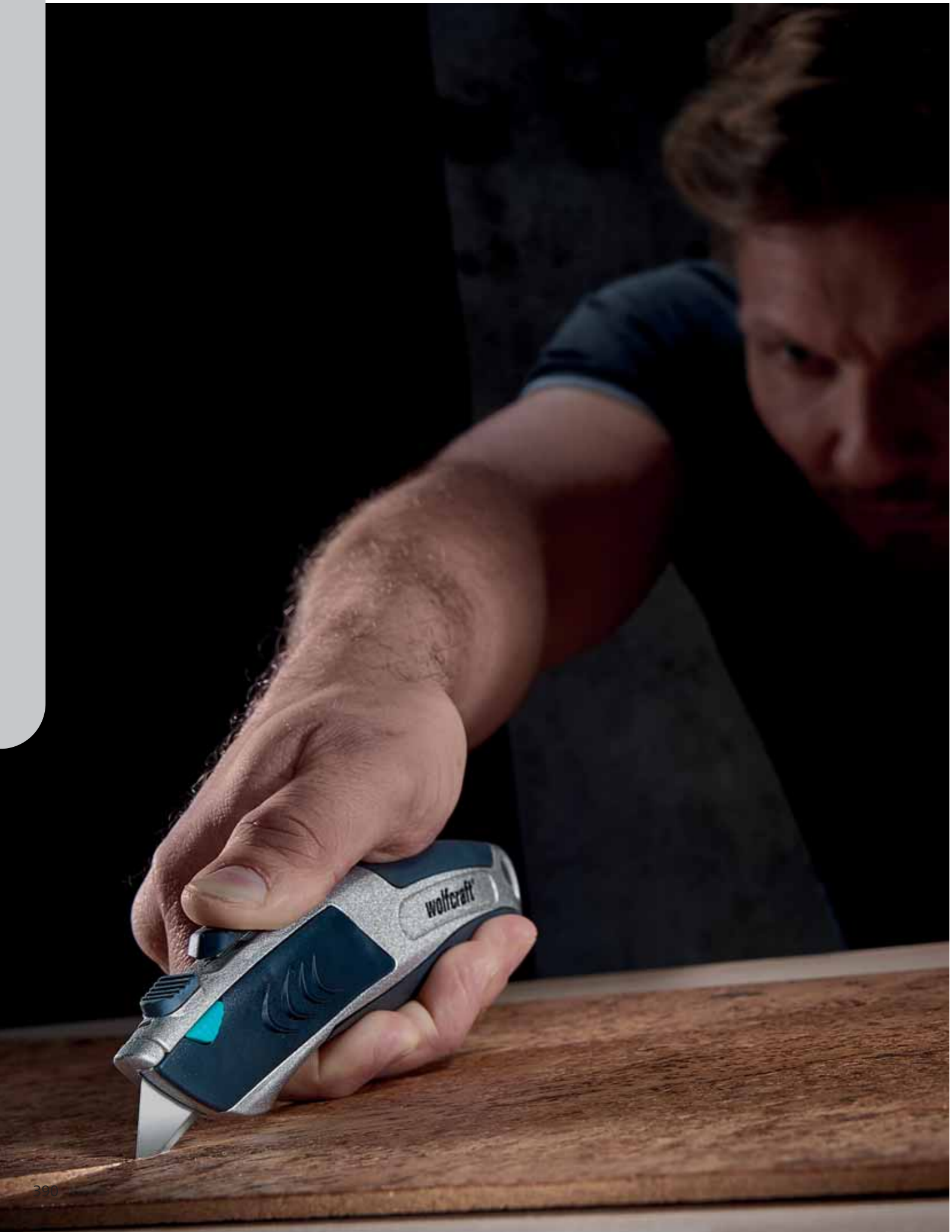

HAND TOOLS 7

7.1 Cutting tools

Trapezium blade knives



Professional knife for continuous use

- automatic blade changes in seconds thanks to auto-load function saves time in continuous use
- ergonomic soft grip zone helps with fatigue-free working
- durable and sturdy metal casing, designed for professional use
- safe and practical storage of interchangeable blades in the integrated blade magazine
- length of blade 61 mm
- including: 6 replacement blades in the magazine
- packaging: blister on card
- separate accessories: 4173000, 4187000, 4307000, 4309000

article no.	EAN	description	version
4320000	...432000	1 professional trapezium blade knife "Auto-Load"	with retractable blade, with magazine for blades



For cutting hard materials using a trapezium or hook blade

- hook and trapezium blade for a variety of applications
- separate, only individually activatable unlocking levers combine safety and comfort
- durable and sturdy metal casing, designed for professional use
- ergonomic soft grip zone helps with fatigue-free working
- special blade holder allows tool-free blade changes
- safe and practical storage of interchangeable blades in the integrated blade magazine
- including:
 - 2 trapezium blades
 - 2 hook blades
- packaging: blister on card
- separate accessories: 4172000, 4173000, 4185000, 4186000, 4188000, 4189000, 4313000, 4314000

article no.	EAN	description	version
4200000	...420007	1 professional dual blade knife	with retractable blade, with magazine for blades

7 HAND TOOLS

7.1 Cutting tools



- ergonomic metal casing for optimal power transmission
- comfortable handle zone
- tool-less blade change at the push of a button
- safety cord cutter
- including: 5 replacement blades in the magazine
- packaging: blister on card
- separate accessories: 4172000, 4173000, 4174000, 4185000, 4186000, 4187000, 4188000, 4189000, 4307000, 4309000, 4313000, 4314000

article no.	EAN	description	version
4131000	4006885... ...413108	1 quick-change trapezium blade knife	with retractable blade, with magazine for blades



- light and robust, ergonomic aluminium casing
- soft zones for safe handling
- tool-less blade change and fast opening
- including: 3 replacement blades in the magazine
- packaging: blister on card
- separate accessories: 4172000, 4173000, 4174000, 4185000, 4186000, 4187000, 4188000, 4189000, 4307000, 4309000, 4313000, 4314000

article no.	EAN	description	version
4132000	4006885... ...413207	1 trapezium blade knife	with retractable blade, with magazine for blades



- metal body for high stability
- soft zones for safe handling
- tool-less blade change by means of a big knurled nut
- including: 1 trapezium blade
- packaging: blister on card
- separate accessories: 4172000, 4173000, 4174000, 4185000, 4186000, 4187000, 4188000, 4189000, 4307000, 4309000, 4313000, 4314000

article no.	EAN	description	version
4133000	4006885... ...413306	1 standard trapezium blade knife	with retractable blade, with magazine for blades

HAND TOOLS 7

7.1 Cutting tools



For safe cutting of hard materials

- optional safety or auto-lock function for a variety of applications
- durable and sturdy metal casing, designed for professional use
- ergonomic soft grip zone helps with fatigue-free working
- button for releasing the blade allows tool-free blade changes
- cord cutter for quick and safe trimming of cords, straps, etc.
- safe and practical storage of interchangeable blades in the integrated blade magazine
- including: 3 trapezium blades
- packaging: blister on card
- separate accessories: 4172000, 4173000, 4185000, 4186000, 4187000, 4307000, 4309000, 4313000, 4314000

article no.	EAN	description	version
4106000	4006885... ...410602	1 professional dual trapezium blade knife	with retractable blade, with magazine for blades



- specifically designed & moulded metal casing for safe working
- safe usage: the blade will slide back automatically as soon as the safety button has been released
- packaging: blister on card
- separate accessories: 4172000, 4173000, 4174000, 4185000, 4186000, 4187000, 4188000, 4189000, 4307000, 4309000, 4313000, 4314000

article no.	EAN	description	version
4134000	4006885... ...413405	1 metal safety knife	with retractable blade



- safe cutting up and opening of cardboard boxes
- safe usage: the blade will slide back automatically as soon as the safety button has been released
- material: plastic material
- including: 1 trapezium blade
- packaging: blister on card
- separate accessories: 4172000, 4173000, 4185000, 4186000, 4187000, 4307000, 4309000, 4313000, 4314000

article no.	EAN	description	version
4135000	4006885... ...413504	1 plastic safety knife	with retractable blade

7 HAND TOOLS

7.1 Cutting tools



Craftsman's knife for cutting hard materials

- fixed blade for cutting solid materials like carpet, plasterboard, vinyl, roofing felt and much more
- sturdy metal casing for durability in continuous use
- ergonomic, anti-slip soft grip zone for comfortable working
- fast change system for blades with magnetic blade fastening for fast, safe and tool-free blade replacement
- sheath made from sturdy ABS plastic with belt clip for safe and easy access
- including: 4 trapezium blades
- packaging: blister on card
- separate accessories: 4172000, 4173000, 4174000, 4185000, 4186000, 4187000, 4188000, 4189000, 4307000, 4309000, 4313000, 4314000

article no.	EAN	description	version
4089000	4006885... ...408906	1 professional trapezium blade knife with sheath	with fixed blade, with magazine for blades



- for for standard hook and trapezium blades
- metal casing with specifically designed & moulded surface
- blade change by means of an integrated screw
- including: 3 trapezium blades
- packaging: blister on card
- separate accessories: 4128000, 4172000, 4173000, 4174000, 4185000, 4186000, 4187000, 4188000, 4189000, 4307000, 4309000, 4313000, 4314000

article no.	EAN	description	version
4150000	4006885... ...415003	1 Standard Cutter - trapezium blade knife	with fixed blade



- metal body for high stability
- tool-less blade change by means of a big knurled nut
- safety humps prevent the hand from slipping down over the blades
- including: 1 professional trapezium blade
- packaging: blister on card
- separate accessories: 4128000, 4172000, 4173000, 4174000, 4185000, 4186000, 4187000, 4188000, 4189000, 4307000, 4309000, 4313000, 4314000

article no.	EAN	description	version
4155000	4006885... ...415508	1 Multi Cutter - trapezium blade knife	with fixed blade

HAND TOOLS 7

7.1 Cutting tools

Snap-off blade knives



- The knife for heavy use - such as heavy cardboard, thick films and roofing felt.
- ergonomic metal casing with comfortable soft zone for optimal power transmission
 - automatic blade lock
 - safety button for locking the blade
 - chrome-plated metal blade guiding
 - including: 1 snap-off blade, with 7 segments
 - packaging: blister on card
 - separate accessories: 4127000, 4203000, 4312000

article no.	EAN	description	blade height	product dimensions
4081000	4006885... ...408104	1 professional snap-off blade knife	25 mm	50 x 190 x 28 mm



Safe cutting of cardboard, cartons and sheetings

- 2 adjustment options for a multitude of applications with just one tool
- optional auto-lock function for fixed blade
- optional safety function enables the blade to automatically retract as soon as the unlocking lever is released
- ergonomic soft grip zone for comfortable handling
- durable and sturdy thanks to metal casing and metal blade guide
- refillable and compatible with all commercially available 18 mm snap-off blades
- special blade holder allows fast, tool-free blade changes
- including: 1 snap-off blade, with 8 segments
- packaging: blister on card
- separate accessories: 4179000, 4181000, 4182000, 4208000

article no.	EAN	description	blade height
4284000	4006885... ...428409	1 professional dual snap-off blade knife	18 mm

7 HAND TOOLS

7.1 Cutting tools



Safe cutting of cardboard, cartons and sheetings

- 2 adjustment options for a multitude of applications with just one tool
- optional auto-lock function for fixed blade
- optional safety function enables the blade to automatically retract as soon as the unlocking lever is released
- ergonomic soft grip zone for comfortable handling
- durable and sturdy thanks to metal casing and metal blade guide
- refillable and compatible with all commercially available 9 mm snap-off blades
- special blade holder allows fast, tool-free blade changes
- including: 1 snap-off blade, with 13 segments
- packaging: blister on card
- separate accessories: 4180000, 4207000

article no.	EAN	description	blade height
4285000	4006885... ...428508	1 professional dual snap-off blade knife	9 mm



For precision cutting of hard materials

- black, extra-sharp blade (up to 40 per cent sharper than conventional snap-off blades) for maximum precision
- sturdy metal casing made of zinc die-cast offers good handling and durability
- refillable and compatible with all commercially available 18 mm snap-off blades
- special blade holder allows fast, tool-free blade changes
- including: 1 snap-off blade, with 8 segments
- packaging: blister on card
- separate accessories: 4179000, 4181000, 4182000, 4208000

article no.	EAN	description	blade height
4306000	4006885... ...430600	1 metal snap-off blade knife	18 mm

HAND TOOLS 7

7.1 Cutting tools



For precision cutting of cardboard, sheetings and paper

- black, extra-sharp blade (up to 30 per cent sharper than conventional snap-off blades) for maximum precision
- sturdy metal casing made of zinc die-cast offers good handling and durability
- refillable and compatible with all commercially available 9 mm snap-off blades
- special blade holder allows fast, tool-free blade changes
- including: 1 snap-off blade, with 13 segments
- packaging: blister on card
- separate accessories: 4180000, 4207000

article no.	EAN	description	blade height
4305000	4006885... ...430501	1 metal snap-off blade knife	9 mm



- ergonomic metal casing with comfortable soft zone for optimal power transmission
- automatic blade lock
- automatic blade change
- safety button for locking the blade
- including: 8 replacement blades
- packaging: blister on card
- separate accessories: 4179000, 4181000, 4182000, 4208000

article no.	EAN	description	version	blade height
4136000	4006885... ...413603	1 professional metal snap-off blade knife	with magazine for blades	18 mm



- ergonomic metal casing with comfortable soft zone for optimal power transmission
- automatic blade lock
- automatic blade change
- including: 5 replacement blades
- packaging: blister on card
- separate accessories: 4180000, 4207000

article no.	EAN	description	version	blade height
4137000	4006885... ...413702	1 professional metal snap-off blade knife	with magazine for blades	9 mm

7 HAND TOOLS

7.1 Cutting tools



- ergonomic plastic body
- soft and comfortable handle zone
- automatic blade lock
- including: 3 replacement blades
- packaging: blister on card
- separate accessories: 4179000, 4181000, 4182000, 4208000

article no.	EAN	description	version	blade height
4138000	4006885... ...413801	1 2C plastic snap-off blade knife	with magazine for blades	18 mm



- ergonomic plastic body
- soft and comfortable handle zone
- automatic blade lock
- including: 3 replacement blades
- packaging: blister on card
- separate accessories: 4180000, 4207000

article no.	EAN	description	version	blade height
4139000	4006885... ...413900	1 2C plastic snap-off blade knife	with magazine for blades	9 mm



- higher safety thanks to a rigid metal guide for the blade
- lockable slide
- removable cap for safely snapping off blade segments
- robust plastic body
- packaging: blister on card
- separate accessories: 4179000, 4181000, 4182000, 4208000

article no.	EAN	description	blade height
4146000	4006885... ...414600	1 standard plastic snap-off blade knife	18 mm



- higher safety thanks to a rigid metal guide for the blade
- lockable slide
- removable cap for safely snapping off blade segments
- robust plastic body
- including: 2 replacement blades
- packaging: blister on card
- separate accessories: 4180000, 4207000

article no.	EAN	description	version	blade height
4141000	4006885... ...414105	1 standard plastic snap-off blade knife	with magazine for blades	9 mm

HAND TOOLS 7

7.1 Cutting tools

Special knives



For cutting insulating materials

- for foam, polystyrene, fibre material, and lots more
- extra-wide stainless steel blade for long, pulling and precisely guided cuts
- precision ground tip for easy entry into the material
- ergonomic plastic handle for comfortable handling
- packaging: sliding blister

article no.	EAN	description	version	length of blade
4097000	4006885... ...409705	1 special professional knife for insulating materials	ergonomic plastic handle	305 mm



- thanks to a sharpened tip also suitable for plungecuts
- specially toothed blade sharpened on both sides for different insulating materials
- with serrated grinding for soft and light material
- with saw grinding for compact and strong material
- packaging: sliding blister

article no.	EAN	description	version	length of blade	length
4119000	4006885... ...411906	1 special knife for insulating materials	with riveted wooden handle	275 mm	420 mm



- for rock wool, rigid foam, polystyrene
- 250 mm serrated blade
- blade with special tothing, processed from one side
- rounded-off safety blade
- packaging: sliding blister

article no.	EAN	description	version
4147000	4006885... ...414709	1 special knife for insulating materials	with plastic handle

7 HAND TOOLS

7.1 Cutting tools



- metal body for high stability
- tool-less blade change by means of a big knurled nut
- including: 1 long blade for insulation materials, serrated blade, 140 mm
- packaging: fixed on card
- separate accessories: 4128000, 4172000, 4173000, 4174000, 4185000, 4186000, 4187000, 4188000, 4189000, 4307000, 4309000, 4313000, 4314000

article no.	EAN	description	version
4148000	4006885... ...414808	1 multi-purpose fixed-blade knife	with fixed blade



- metal body for high stability
- tool-less blade change by means of a big knurled nut
- including: 3 professional crescent-shaped blades
- packaging: blister on card
- separate accessories: 4128000, 4172000, 4173000, 4174000, 4185000, 4186000, 4187000, 4188000, 4189000, 4307000, 4309000, 4313000, 4314000

article no.	EAN	description	version
4149000	4006885... ...414907	1 multi-purpose fixed-blade knife	with fixed blade



- for stripping cables and wires
- for sawing small plastic pieces
- foldable blade - with cable and wire cutter
- sharpened blade, serrated over half its length
- packaging: sliding blister

article no.	EAN	description	version	length of blade	length
4122000	4006885... ...412200	1 cable knife	with plastic handle	85 mm	195 mm

HAND TOOLS 7

7.1 Cutting tools



- for stripping cables and wires
- foldable blade - with cable and wire cutter
- keen-edged blade made of stainless steel
- packaging: sliding blister

article no.	EAN	description	version	length of blade	length
4123000	4006885... ...412309	1 cable knife	with wooden handle	85 mm	197 mm



- for paper, sheetings, leather, and lots more
- material: plastic material
- including: 2 replacement blades in the magazine
- packaging: blister on card
- separate accessories: 4169000

article no.	EAN	description	version
4151000	4006885... ...415102	1 circle cutter	with magazine for blades



- for very exact cutting work
- light aluminium handle
- anti-slip soft zone for a safe grip
- packaging: blister on card
- separate accessories: 4196000

article no.	EAN	description
4195000	4006885... ...419506	1 precision knife



- straight and curved cuts
- for cutting of fabric and paper
- with lever and additional button for safe locking
- material: plastic material
- packaging: blister on card
- separate accessories: 4129000

article no.	EAN	description	version
4152000	4006885... ...415201	1 rolling knife	incl. one replaceable 45 mm blade

7 HAND TOOLS

7.1 Cutting tools

Outdoor knives



Versatile leisure knife for hobby and camping

- 70 mm blade with smooth cutting edge for a variety of applications
- metal casing with aluminium handles offers stability with low weight
- safety mechanism when folding and releasing reduces the risk of injury
- nail recess on the blade for two-handed operation according to weapons law
- including belt clip
- packaging: blister on card

article no.	EAN	description	version	length of blade
4288000	4006885... ...428805	1 folding and leisure knife	smooth blade	70 mm



Versatile leisure knife for hobby and camping

- 75 mm blade with serrated cutting edge for a variety of applications
- metal casing with aluminium handles offers stability with low weight
- safety mechanism when folding and releasing reduces the risk of injury
- nail recess on the blade for two-handed operation according to weapons law
- including belt clip
- packaging: sliding blister

article no.	EAN	description	version	length of blade
4289000	4006885... ...428904	1 folding and leisure knife	combination blade, smooth/serrated	75 mm



Folding knife for leisure, hobby and camping

- folding metal casing with aluminium handles, lightweight and practical for on the move
- special holder allows tool-free blade changes
- compatible with all commercially available trapezium, hook and curved blades and therefore suitable for a wide range of applications
- safety button for folding and release ensuring compliance with two-handed operation according to weapons law
- packaging: sliding blister
- separate accessories: 4172000, 4173000, 4174000, 4185000, 4186000, 4187000, 4188000, 4189000, 4307000, 4309000, 4313000, 4314000

article no.	EAN	description
4104000	4006885... ...410404	1 folding knife for trapezium blades

HAND TOOLS 7

7.1 Cutting tools



- for all common trapezium blades
- easy & tool-free blade changing
- light but sturdy aluminium handles
- including belt clip
- locking mechanism of the blade
- packaging: sliding blister
- separate accessories: 4172000, 4173000, 4174000, 4185000, 4186000, 4187000, 4307000, 4309000, 4313000, 4314000

article no.	EAN	description	version
4124000	4006885... ...412408	1 aluminium leisure knife	with retractable blade



Folding 13-in-1 tool

- 13 folding tools, compact and practical, ideal for hobby, DIY, camping and travel
- needle nose pliers, combination pliers, wire cutter, knife blade, piercing awl, Phillips screwdriver, saw, file on both sides (wood + metal), flat-head screwdriver, bottle opener, can opener, hook blade
- high-quality metal design with detent function and release for safe use
- including belt loop and nylon sheath
- packaging: sliding blister

article no.	EAN	description
4080000	4006885... ...408005	1 multi tool



Knife for hobby, craft and camping

- fixed stainless steel blade for a variety of applications
- ergonomic handle with soft grip zone for comfortable handling
- protective sheath made of plastic for attachment to the belt for easy access
- packaging: sliding blister

article no.	EAN	description	version	length of blade
4085000	4006885... ...408500	1 outdoor knife	smooth blade	95 mm
4086000	4006885... ...408609	1 outdoor knife	serrated blade	95 mm

7 HAND TOOLS

7.1 Cutting tools

Blades

- sharpened from both sides
- ice-hardened special steel
- sharp, break-proof, durable
- in practical storage box

Trapezium blades



- TiN coating for a 4 to 5 times higher durability and lasting cutting results
- material: stainless HCS steel, TiN coated
- in storage box
- packaging: blister on card

article no.	EAN 4006885...	description	length of blade	thickness of blade	suitable for
4172000	...417205	5 professional trapezium blades	52 mm	0.65 mm	4089000, 4104000, 4106000, 4124000, 4131000, 4132000, 4133000, 4134000, 4135000, 4148000, 4149000, 4150000, 4155000, 4200000
4173000	...417304	5 professional trapezium blades	61 mm	0.65 mm	4089000, 4104000, 4106000, 4124000, 4131000, 4132000, 4133000, 4134000, 4135000, 4148000, 4149000, 4150000, 4155000, 4193000, 4197000, 4200000, 4320000



- material: stainless HCS steel
- in storage box
- packaging: blister on card

article no.	EAN 4006885...	description	length of blade	thickness of blade	suitable for
4185000	...418509	5 trapezium blades	52 mm	0.5 mm	4008000, 4009000, 4014000, 4089000, 4104000, 4106000, 4124000, 4131000, 4132000, 4133000, 4134000, 4135000, 4148000, 4149000, 4150000, 4155000, 4200000
4186000	...418608	5 professional trapezium blades	52 mm	0.65 mm	4089000, 4104000, 4106000, 4124000, 4131000, 4132000, 4133000, 4134000, 4135000, 4148000, 4149000, 4150000, 4155000, 4200000
4313000	...431300	10 professional trapezium blades	52 mm	0.65 mm	4089000, 4104000, 4106000, 4124000, 4131000, 4132000, 4133000, 4134000, 4135000, 4148000, 4149000, 4150000, 4155000, 4200000
4187000	...418707	5 professional trapezium blades	61 mm	0.65 mm	4089000, 4104000, 4106000, 4124000, 4131000, 4132000, 4133000, 4134000, 4135000, 4148000, 4149000, 4150000, 4155000, 4193000, 4197000, 4320000
4307000	...430709	10 professional trapezium blades	61 mm	0.65 mm	4089000, 4104000, 4106000, 4124000, 4131000, 4132000, 4133000, 4134000, 4135000, 4148000, 4149000, 4150000, 4155000, 4193000, 4197000, 4320000

HAND TOOLS 7

7.1 Cutting tools



- in practical dispenser box
- material: stainless HCS steel
- in storage box
- packaging: blister on card

article no.	EAN	description	length of blade	thickness of blade	suitable for
4314000	...431409	100 professional trapezium blades	52 mm	0.65 mm	4089000, 4104000, 4106000, 4124000, 4131000, 4132000, 4133000, 4134000, 4135000, 4148000, 4149000, 4150000, 4155000, 4200000
4309000	...430907	100 professional trapezium blades	61 mm	0.65 mm	4089000, 4104000, 4106000, 4124000, 4131000, 4132000, 4133000, 4134000, 4135000, 4148000, 4149000, 4150000, 4155000, 4193000, 4197000, 4320000



- in storage box
- packaging: blister on card

article no.	EAN	description	length of blade	thickness of blade	suitable for
4188000	...418806	5 hook blades	51 mm	0.5 mm	4014000, 4089000, 4104000, 4131000, 4132000, 4133000, 4134000, 4148000, 4149000, 4150000, 4155000, 4200000
4189000	...418905	5 heavy-duty hook blades	51 mm	0.65 mm	4089000, 4104000, 4131000, 4132000, 4133000, 4134000, 4148000, 4149000, 4150000, 4155000, 4200000



- specifically ground for processing gypsum plasterboards
- for slightly scratching the plasterboard surface
- TiN coating for a 4 to 5 times higher durability and lasting cutting results
- in storage box
- packaging: blister on card
- suitable for 4089000, 4104000, 4124000, 4131000, 4132000, 4133000, 4134000, 4148000, 4149000, 4150000, 4155000

article no.	EAN	description	length of blade	thickness of blade
4174000	...417403	5 professional crescent-shaped blades	58 mm	0.65 mm

7 HAND TOOLS

7.1 Cutting tools



- for rock wool, polystyrene
- packaging: bag
- suitable for 4148000, 4149000, 4150000, 4155000

article no.	EAN	description	version	length of blade	thickness of blade
4128000	4006885... ...412804	2 long blades for insulation materials	serrated blade	140 mm	0.85 mm

Snap-off blades



Professional blade for heavy use - such as heavy cardboard, thick films and roofing felt.

- sharpened from both sides, with double facet
- material: HCS
- packaging: blister on card
- suitable for 4081000

article no.	EAN	description	segments	blade height	thickness of blade
4127000	4006885... ...412705	5 professional snap-off blades	7	25 mm	0.7 mm
4312000	...431201	10 professional snap-off blades	7	25 mm	0.7 mm



- extra sharp - 30% sharper than standard blades (as per VPA certificate)
- suitable for all commercially available snap-off blade knives
- in storage box
- packaging: blister on card

article no.	EAN	description	version	segments	blade height	suitable for
4207000	4006885... ...420700	5 professional sharp snap-off blades	black	13	9 mm	4137000, 4139000, 4141000, 4285000, 4305000
4208000	...420809	5 professional sharp snap-off blades	black	8	18 mm	4136000, 4138000, 4146000, 4284000, 4306000

HAND TOOLS 7

7.1 Cutting tools



- article no. 4182000: with 15 segments (twice as many as usual)
- in storage box
- packaging: blister on card

article no.	EAN 4006885...	description	segments	blade height	suitable for
4180000	...418004	5 snap-off blades	13	9 mm	4137000, 4139000, 4141000, 4285000, 4305000
4181000	...418103	5 snap-off blades	8	18 mm	4136000, 4138000, 4146000, 4284000, 4306000
4182000	...418202	5 professional snap-off blades	15	18 mm	4136000, 4138000, 4146000, 4284000, 4306000



- in storage box
- packaging: blister on card
- suitable for 4136000, 4138000, 4146000, 4284000, 4306000

article no.	EAN 4006885...	description	segments	blade height
4179000	...417908	5 snap-off hook blades	4	18 mm

Miscellaneous blades



- in storage box
- packaging: blister on card
- suitable for 4152000

article no.	EAN 4006885...	description
4129000	...412903	1 replacement blade for rolling knife



- packaging: blister on card
- suitable for 4300000

article no.	EAN 4006885...	description
4310000	...431003	3 replacement blades for laminate trimmer



- in storage box
- packaging: blister on card
- suitable for 4151000

article no.	EAN 4006885...	description
4169000	...416901	5 replacement blades for circle cutter

7 HAND TOOLS

7.1 Cutting tools



- in storage box
- packaging: blister on card
- suitable for 4195000

article no.	EAN	description	
4196000	4006885... ...419605	5 replacement blades for precision knife	



- packaging: blister on card
- suitable for 4100000, 4101000

article no.	EAN	description	
4126000	4006885... ...412606	3 replacement blades for scraper	



- material: fixed stainless steel blade for a variety of applications
- packaging: blister on card
- suitable for 4081000

article no.	EAN	description	length of blade
4203000	4006885... ...420304	2 saw blades for snap-off blade knife	25 mm

Scissors



an integrated safety catch will reduce the risk of injury

Make a clean cut - safe, quick and precise!

- bidirectional razor-sharp blade
- central recess in blade holder for easy cutting of round material with diameters of up to 13 mm
- a spring-loaded safety cover on the front of the blade holder will prevent accidental contact
- an integrated safety catch will reduce the risk of injury
- ergonomically designed handle with non-slip elastic coating
- including: 1 replacement blade, 0.65 mm thick, 61 mm long
- packaging: double blister
- separate accessories: 4173000, 4187000, 4307000, 4309000

article no.	EAN	description	
4197000	4006885... ...419704	1 megaCut S - all-purpose cutter	

HAND TOOLS 7

7.1 Cutting tools



with additional functions, such as screwdriver, bottle-opener, foil cutter

- with ergonomic handles
- with special cutting edge geometry
- with additional functions, such as screwdriver, bottle-opener, foil cutter
- packaging: blister on card

article no.	EAN	description	length	length of blade
4164000	4006885... ...416406	1 universal household scissors	215 mm	70 mm



- for cutting paper, fabric and other thin materials
- permanent and secure blade joint
- stainless steel blades
- ergonomic 2-component handle zones
- packaging: sliding blister

article no.	EAN	description	length	length of blade
4117000	4006885... ...411708	1 household scissors	250 mm	130 mm

Miscellaneous



- for cutting glass as well as tiles or ceramics
- for glass widths 3 - 8 mm
- version:
wooden handle
with 6 changeable cutting discs made of tungsten carbide
- packaging: sliding blister

article no.	EAN	description	length
4109000	4006885... ...410909	1 professional glass and tile cutter	135 mm



- for glass widths 3 - 5 mm
- version:
with painted wooden handle
with 6 changeable cutting discs made of tungsten carbide
- packaging: sliding blister

article no.	EAN	description	length
4108000	4006885... ...410800	1 standard glass cutter	135 mm

7 HAND TOOLS

7.1 Cutting tools



For professional cleaning of smooth surfaces

- metal-reinforced plastic casing with ergonomic soft grip zone for comfortable handling
- sturdy metal blade guide for reliable continuous use
- special holder allows tool-free blade changes
- compatible with all commercially available 38 mm scraper blades for long reusability
- packaging: fixed on card
- separate accessories: 4126000

article no.	EAN	description	blade height
4100000	4006885... ...410008	1 professional scraper	38 mm



For cleaning smooth surfaces

- plastic casing with ergonomic soft grip zone for comfortable handling
- plastic slide for surface-friendly cleaning
- special holder allows tool-free blade changes
- compatible with all commercially available 38 mm scraper blades for long reusability
- packaging: fixed on card
- separate accessories: 4126000

article no.	EAN	description	blade height
4101000	4006885... ...410107	1 2C plastic scraper	38 mm



- to eliminate minor flatness faults on smooth surfaces
- for removing stickers from smooth surfaces
- to remove varnish and paint
- material: plastic material
- version: 61 mm blade
- including: 1 blade
- packaging: fixed on card
- separate accessories: 4173000, 4187000, 4307000, 4309000

article no.	EAN	description
4193000	4006885... ...419308	1 plastic scraper

HAND TOOLS 7

7.1 Cutting tools



For cleaning sensitive surfaces

- 4 plastic blades for particularly sensitive surfaces in 2 hardnesses: medium and hard for tailored cleaning
- plastic casing with magazine for practical replacement blade storage
- special holder allows tool-free blade changes
- version: plastic casing with magazine for replacement blades
- packaging: fixed on card

article no.	EAN	description
4287000	4006885... ...428706	1 scraper with plastic blades



- for the trimming of overlapping veneers
- also for the clean cutting of shaped edges
- packaging: blister on card
- separate accessories: 4310000

article no.	EAN	description
4300000	4006885... ...430006	1 laminate trimmer



For wearing knife on belt

- suitable for many knife sizes
- piercing protection thanks to robust plastic reinforcement
- material: nylon
- version: sewn and riveted
- length of bag 120 mm
- packaging: fixed on card

article no.	EAN	description	length	product dimensions	weight
4281000	4006885... ...428102	1 knife holster	205 mm	110 x 220 x 50 mm	0.07 kg

7 HAND TOOLS

7.2 Measuring tools



7.2 Measuring tools

1 stair gauge

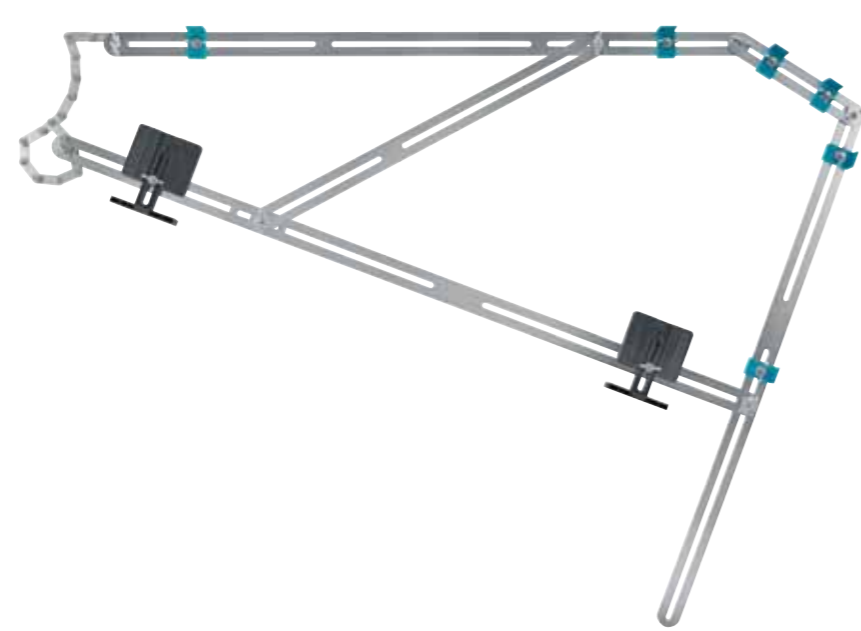
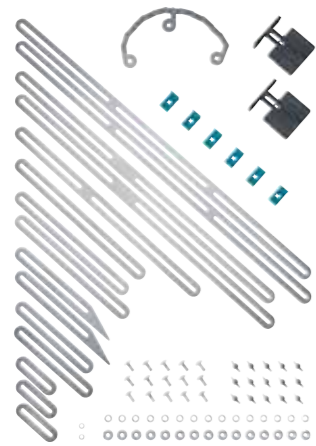

For measuring steps

- 15 galvanized steel rails in different sizes for measuring stair steps
- screws with wing nuts for easy handling in corners in particular and secure fastening
- stable, transportable fixing of the contour for easy and error-free transfer
- set for precise gauging of demanding step measurements and reliable transfer to the workpiece
- flexible chain element for gauging curves of spiral staircases
- integrated expansion joint wedges and adapters for error-free consideration of material allowances
- ideal for wooden staircases, wooden spiral staircases and staircases with steps that are challenging to measure
- packaging: covering box

article no.	EAN	description
5210000	4006885... ...521001	1 stair gauge

7 HAND TOOLS

7.2 Measuring tools



For processing three-dimensional workpieces

- for wooden beams, tubes
- 45° and 90° limit stop for fast measuring and marking
- marking gauge function for parallel lines
- integrated drill gauge for determination of drill diameters
- rectangular geometry for precise, three-dimensional markings
- angle scale for measuring and drawing free angles from 0-90°
- material: plastic material
- packaging: fixed on card



article no.	EAN	description	product dimensions
5208000	4006885...520806	1 3D mitre angle	212 x 62 x 74 mm



- material: beech wood
- packaging: bulk
- separate accessories: 5221000, 5222000, 5223000



article no.	EAN	description	length
5227000	4006885...522701	1 rule	2 m



For scoring and marking work pieces

- limit stop for fast and precise positioning
- integrated centring pin enables use as a compass
- high-quality plastic design for durability
- geometry enables use with all commercially available rules
- packaging: fixed on card
- suitable for 5227000



article no.	EAN	description
5221000	4006885...522107	1 marking gauge for folding rules

7.2 Measuring tools



For aligning pictures and workpieces

- this allows it to be used in a way that is based on the principle employed in spirit levels
- for horizontal alignment using the rule
- durable and robust plastic variant
- geometry enables use with all commercially available rules
- packaging: fixed on card
- suitable for 5227000

article no.	EAN	description
5222000	4006885... ...522206	1 level for folding rules



For taking internal measurements using a folding rule

- turns any commercially available folding rule into a multi-functional measuring instrument
- for exact measurements in places hard to reach with the rule
- ideal for measuring shelves
- durable and robust plastic variant
- packaging: fixed on card
- suitable for 5227000

article no.	EAN	description
5223000	4006885... ...522305	1 internal dimension adapter for rules

7 HAND TOOLS

7.2 Measuring tools



- For measuring, marking, drawing and guided cutting
- flat square, angle measuring scale, parallel marker, marking stencil and drill guide for concealed hinges in one device— saves money and space
 - removable plastic limit stop for precise working on surfaces or edges
 - scale on both sides for easy reading in every position
 - sturdy and durable thanks to high-quality metal design
 - material: steel
 - version: flat square, angle measuring scale, parallel marker, marking stencil
 - try square 90°
 - raster 32 mm
 - packaging: sleeve

article no.	EAN	description	leg length
5205000	4006885... ...520509	1 universal angle & try square	200 x 300 mm
5206000	...520608	1 universal angle & try square	280 x 500 mm

PROJECT THEMES 8
8.1 Laying laminate and vinyl



8.1 Laying laminate and vinyl

Shortening

The convenient solution for extensive laminate and vinyl laying jobs

1 VLC 800 - vinyl and laminate cutter



- for fast, safe cutting of all laminate types (including with integrated footfall sound insulation) with a thickness of up to 11 mm and width of 465 mm
- for self-adhesive and click vinyl planks and vinyl tiles with thicknesses of up to 6 mm and widths of 465 mm
- adjustable cutting gap for cutting flexible vinyl with a thickness of 2 - 4 mm
- for precise 90° cuts with limit stop
- for angular cuts from 0° - 180°
- for cutting planks in longitudinal direction
- coated blade for easy cutting of self-adhesive vinyl planks
- practical parallel guide for 55 mm wide strip cuts, can be installed on the left or right
- incl. hold-down function for the easy and comfortable cutting of extra wide boards
- incl. support for the panels
- fast, safe cutting thanks to special blade geometry
- clean cut on the decorative side
- serrated cutter bars for secure fastening of the workpiece during initial blade contact
- safe footing with anti-skid cushion feet
- dust-free and low-noise working
- light and sturdy thanks to high-quality aluminium design
- packaging: covering box

article no.	EAN	description	product dimensions	weight
6939000	4006885... ...693906	1 VLC 800 - vinyl and laminate cutter	661 x 211 x 197 mm	3.5 kg

PROJECT THEMES 8

8.1 Laying laminate and vinyl



LC 600 - laminate cutter

For standard laminate laying jobs

- for safe cutting of all laminate types with a thickness up to 8 mm (including with integrated footfall sound insulation up to 11 m) and width of 465 mm
- for precise 90° cuts with limit stop
- for angular cuts from 0° - 180°
- for cutting planks in longitudinal direction
- permits precise, unlimited longitudinal cuts thanks to serrated cutting bars
- clean cut on the decorative side
- serrated cutter bars for secure fastening of the workpiece during initial blade contact
- fast, safe cutting thanks to special blade geometry
- dust-free and low-noise working
- light and sturdy thanks to high-quality aluminium design
- sturdy footing with anti-skid cushion feet
- packaging: covering box

article no.	EAN	description	product dimensions	weight
6937000	4006885... ...693708	1 LC 600 - laminate cutter	636 x 201 x 186 mm	2 kg



LC 100 - laminate cutter

For simple laminate laying jobs

- ideal for carrying out simple laminate installation projects
- for quick and clean cutting of laminate with a thickness of up to 8 mm and a width of 210 mm
- for 90° cuts with limit stop
- alternative to using power tools such as chop saws or jigsaws
- fast, safe cuts
- dust-free and low-noise working
- easy cutting thanks to special blade geometry
- sturdy footing with anti-skid cushion feet
- packaging: covering box

article no.	EAN	description	product dimensions	weight
6933000	4006885... ...693302	1 LC 100 - laminate cutter	580 x 203 x 177 mm	1.7 kg

8 PROJECT THEMES

8.1 Laying laminate and vinyl



- for wood, wood core chipboards, plastic coated chipboards, baseboards
- material: HCS
- tooth form: straight-set and ground
- tooth distance: 1,7 mm
- tooth version: pointed teeth
- toothed length: 300 mm
- for cutting material with a max. thickness of 73 mm
- complementary products: 6948000

article no.	EAN	description	cutting width	product dimensions	weight
6950000	4006885... ...695009	1 handsaw	1.2 mm	95 x 410 x 45 mm	0.34 kg

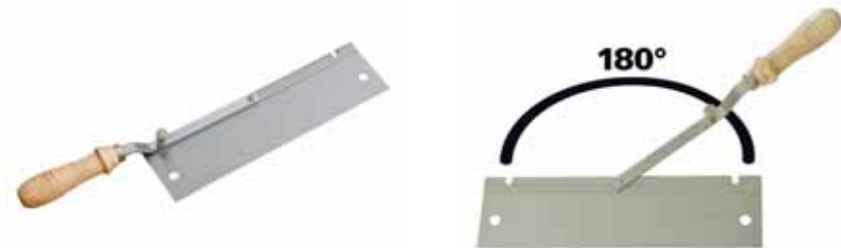

with bent and rotating handle



Door frames can be shortened easily with the handsaw, ideal for accurately finishing floor laying & other jobs.

- the bent handle ensures satisfactory cutting freedom when working close to the floor
- the handle is tiltable by 180° and ensures a safe guiding in all positions as well as its use by both left-handers and right-handers
- toothed length: 255 mm
- packaging: sleeve

article no.	EAN	description	product dimensions
6925000	4006885... ...692503	1 handsaw	90 x 390 x 45 mm

PROJECT THEMES 8

8.1 Laying laminate and vinyl



- for wood, wooden beams, baseboards, branches, plastic pipes
- the saw cuts on the pull stroke - fine cuts and easy sawing
- thin, flexible saw blade, rust-proof
- long, ergonomic, 2-component handle
- remove saw blade without tools - for space-saving storage
- material: WS
- tooth version: Japan toothing
- toothed length: 240 mm
- version:
 - teeth on both sides, hardened
 - side for cross cuts: 17 teeth per inch, pointed and precision ground
 - side for longitudinal cuts: 8 teeth per inch, straight-set and precision ground
- packaging: sleeve

article no.	EAN	description	product dimensions	weight
6951000	4006885... ...695108	1 Japanese saw	570 x 80 mm	0.285 kg

Installing



- 3-in-1 function:
- for joint-free attachment of laminate and parquet without hammer, tapping block and pulling ledge
 - for joining the panels adjacent to the wall to the area already laid
 - can be used in push or pull direction
 - replaces hammer, tapping block and pulling ledge
 - reduces the error rate to zero: rules out injuries and damage caused by the hammer
 - combines force and control in one safe and ergonomic product
 - for planks with thicknesses of 7 mm and above
 - packaging: fixed on card



article no.	EAN	description	product dimensions	weight
6945000	4006885... ...694507	1 hammer pulling ledge	170 x 80 x 410 mm	1.53 kg

8.1 Laying laminate and vinyl



large area underneath lined with felt to allow gentle working

- for arranging layers of laminate next to each other
- mainly used at room ends, so as to fit a layer of laminate under a door frame etc.
- professional design with large contact surface and lever function
- large area underneath lined with felt to allow gentle working
- packaging: bulk



article no.	EAN	description	version	product dimensions
6928000	4006885... ...692800	1 profi crow bar	with anvil and protective pad	120 x 60 x 440 mm



- for arranging layers of laminate next to each other
- mainly used at room ends, so as to fit a layer of laminate under a door frame etc.
- with 3 felt pads underneath for gentle working
- packaging: bulk



article no.	EAN	description	version	product dimensions
6927000	4006885... ...692701	1 pulling ledge	conically shaped	310 x 15 x 25 mm

PROJECT THEMES 8

8.1 Laying laminate and vinyl



- for positioning and engaging laminate and parquet planks for joint-free connections
- ideal for extensive installation jobs in several rooms
- for laminate, parquet, vinyl floor, wood flooring
- long-life design thanks to protective strip made of aluminium
- optimum application of the hammer blow force thanks to the convex shape of the aluminium strip
- the tool shape is ideal for gently handling the laminate's tongue and groove
- suitable for all laminate thicknesses – 5, 10, 15 mm
- material: wood with aluminium rail
- packaging: bulk



article no.	EAN	description	product dimensions	weight
6947000	4006885... ...694705	1 professional mallet	62 x 24 x 281 mm	0.308 kg



- for positioning and arranging laminate from the front side
- the tool shape is ideal for gently handling the laminate's tongue and groove
- packaging: bulk



article no.	EAN	description	product dimensions
6929000	4006885... ...692909	1 mallet	300 x 27 x 50 mm

8 PROJECT THEMES

8.1 Laying laminate and vinyl



2-in-1 function:

- as a spacer for creating an expansion joint when laying laminate or parquet
- as a wedge when squaring windows or doors
- latching mechanism for connecting two or more wedges in both directions
- push-fit connection permits wedge or block shape
- perfect for expansion joints that have to be up to or greater than 10 mm
- hold tightly together and dispense with frequent reassembly
- material: plastic material
- packaging: plastic bag on card



article no.	EAN	description	product dimensions
6946000	4006885... ...694606	30 universal wedges	35 x 6 x 60 mm



Universal standard model for DIY jobs to be done on a kneeling position



- high-quality all-round knee pads for floor laying jobs or other kneeling activities
- thanks to the transparent protection cap the pads, are suitable for both rough and sensitive surfaces
- joint-protecting cushioning effect through elastic gel inserts
- high wearing comfort and ease of movement due to ergonomic one-band fixation
- universal tape fastener for all sizes
- according to DIN EN 14404

article no.	EAN	description
4860000	4006885... ...486003	1 pair comfort knee pads



Attractively priced basic equipment for laying laminate.

- for laminate, parquet, cork
- content:
 - 1 pulling ledge
 - 1 mallet
 - 20 spacer wedges, plastic material
- packaging: double blister



article no.	EAN	description
6931000	4006885... ...693104	1 laminate laying set

PROJECT THEMES 8

8.1 Laying laminate and vinyl

Measuring



For precise measurement of the last row of laminate

- integrated sliding wheel for precise measurement of the wall contour up to a board width of 235 mm
- extra-wide rail for secure support of the laminate board
- supported pin guidance for clean lines
- packaging: fixed on card



article no.	EAN	description
6952000	4006885... ...695207	1 laminate fitter



- 2-in-1 function: bevel gauge and mitre box in one product
- for sawing precise mitres
- for measuring angles from 85° - 180°
- suitable for baseboards up to a width of 30 mm
- automatic, error-free transfer of the correct angle to the saw thanks to integrated guide pins for the handsaw (mitre)
- comfortable measuring of room angles
- especially suitable for old buildings thanks to infinite adjustment from 85° - 180°
- no more head scratching when transferring the correct angle to the saw
- packaging: fixed on card



article no.	EAN	description	max. height baseboards	angle	product dimensions	weight	complementary products
6948000	4006885... ...694804	1 bevel and mitre box	70 mm	85 - 180°	100 x 105 x 353 mm	0.6 kg	6950000
6948200	4006885... ...694828	1 bevel and mitre box	100 mm	85 - 180°	100 x 140 x 353 mm	0.66 kg	4024000

8 PROJECT THEMES

8.1 Laying laminate and vinyl



- helps measuring the wall angle and determines the cutting angle
- automatic display of the cutting angle - for the exact setting of all mitre box saws and matching angle cut
- integrated angle stop for setting angles in an easy way
- magnet for adjusting the saw in an easy and safe way
- packaging: sleeve

article no.	EAN	description	angle	product dimensions
6921000	4006885... ...692107	1 angular bevel gauge	30 - 180°	50 x 345 x 70 mm



The contour gauge permits the simple scanning of the cutting line and its transfer onto the material to be laid.

- to transfer corners and contours - easy and accurate
- ideal for an accurate fitting of the laminate, e.g. around heating pipes
- with clamping lever for fixing the contour tips - no slipping of the contour
- sturdy plastic design
- contour width max. 130 mm, contour depth max. 30 mm
- packaging: blister on card

article no.	EAN	description	product dimensions	weight
6949000	4006885... ...694903	1 contour gauge	180 x 20 x 105 mm	0.2 kg

PROJECT THEMES 8
8.2 Processing plasterboards



8 PROJECT THEMES

8.2 Processing plasterboards

Erecting stud frames



- straight and curved cuts
- lever transmission
- micro-dovetailing for a better cutting result - facilitates the initial cut for smooth metal sheets
- closing mechanism with one-hand opening
- the handles of the scissor are made of slip-resistant 2-component plastic
- in plastic box

article no.	EAN	description	product dimensions
4027000	4006885... ...402706	1 metal shears	75 x 255 x 22 mm



- for C and U metal profiles (maximum thickness 2 x 0.6 mm)
- quick and easy joining of steel profiles
- for joining two upright profiles permanently
- minimal effort through optimal leverage
- packaging: sliding blister

article no.	EAN	description	product dimensions
4029000	4006885... ...402904	1 profile compound pliers	95 x 270 x 36 mm

8.2 Processing plasterboards

Cutting



- for scoring, breaking and cutting plasterboards in one pass
- for precise, straight cutting edges
- does away with the need to keep moving and turning the plasterboards
- ergonomic handle position for comfortable handling
- easy blade changes
- max. cutting length 900 mm, max. cutting length with extension (part no. 4019000) 1900 mm
- including:
 - 1 trapezium blade, 52 / 0,50 mm
 - 1 hook blade, 51 / 0,50 mm
- packaging: paperboard card
- separate accessories: 4019000, 4185000, 4188000

article no.	EAN	description
4014000	4006885... ...401402	1 plasterboard cutter with rail



- for extending the bar of the plasterboard cutter part no. 4014000
- max. cutting length 1900 mm (plasterboard cutter with rail extension)
- packaging: paperboard card
- suitable for 4014000

article no.	EAN	description
4019000	4006885... ...401907	1 rail extension

8.2 Processing plasterboards



10

- cutting and marking aid for precise angular and parallel cuts in plasterboard
- replaces the cumbersome calculation and transfer of angles and dimensions to the plank
- high-precision angle cuts for exact joints reduce subsequent filling and sanding work
- durable thanks to corrosion-resistant surface made of anodised aluminium
- max. cutting length 1000 mm, max. cutting width with parallel cutter 970 mm, angular cuts from 0 - 180°
- including:
 - 1 parallel and strip cutters
 - 1 trapezium blade, 52 / 0,50 mm
- packaging: paperboard card
- separate accessories: 4185000

article no.	EAN	description
4008000	4006885... ...400801	1 T-square with parallel cutter



MADE IN EU

- for front edges with a perfect 35° angle
- for clean transitions between two plasterboards
- suitable for board thicknesses of 9.5 and 12.5 mm
- three blades for precise cutting edge in one pass
- controlled and safe working from the first to the last millimetre
- permits subsequent gentle and fast filling
- including: 3 trapezium blades, 52 / 0,50 mm
- packaging: fixed on card
- separate accessories: 4185000

article no.	EAN	description
4009000	4006885... ...400900	1 triple-blade edge planer

PROJECT THEMES 8

8.2 Processing plasterboards



- for effective reworking of areas and edges on plasterboard and wood
- wide rasp surface of 150 x 57 mm
- ergonomic working with just one hand
- robust plastic body
- packaging: fixed on card
- separate accessories: 4039000

article no.	EAN	description
4013000	4006885... ...401303	1 block plane



- suitable for 4013000

article no.	EAN	description	product dimensions
4039000	4006885... ...403901	1 rasp plate	150 x 57 mm



- for chamfering edges and smoothing out joints
- 2-component handle with soft zone for convenient and safe handling
- replaceable rasping plate (art. no. 4041000)
- packaging: folding box

article no.	EAN	description	product dimensions
4026000	4006885... ...402607	1 edge planer	57 x 258 x 94 mm

8.2 Processing plasterboards



- for wolcraft edge planer part no. 4025000, 4026000

article no.	EAN	description	product dimensions
4041000	4006885... ...404106	1 rasp plate	250 x 57 mm



- for sawing plasterboard, plastic and wood
- ideal for fitting door cut-outs during drywall installation
- versatile thanks to 350 mm blade length and conically ground and hardened tooth tips
- durable, impact-resistant plastic grab handle
- material: HCS
- tooth distance: 3,6 mm
- packaging: sleeve
- complementary products: 6948200

article no.	EAN	description	cutting width	weight
4024000	4006885... ...402409	1 board saw	1.5 mm	0.27 kg



- for cut-outs in plasterboards
- 2-component handle with soft zone for convenient and safe handling
- cutting teeth ground into the blade's body for an easy first cut and fast sawing progress
- induction-hardened teeth for long life
- ground tip for plunge cuts
- packaging: double blister

article no.	EAN	description	product dimensions
4033000	4006885... ...403307	1 hand jigsaw	45 x 318 x 30 mm

8.2 Processing plasterboards



- for sawing recesses and free forms in board material
- ideal for use on drywalls
- 5 mm Ø makes it possible to saw small radii
- easy to guide using the 2-component handle
- packaging: double blister

article no.	EAN	description	working length	Ø	length
4031000	4006885... ...403109	1 hand-keyhole saw	175 mm	Ø 5 mm	275 mm

Positioning - clamping - fixing



- indispensable for larger boards as well as one-man installation jobs on ceilings and inclined areas
- max. loading 30 kg
- telescopes from 1.6 to 2.9 m, coarse setting at inner tube - fine tuning with pump mechanism
- packaging: sticker

article no.	EAN	description	product dimensions
4042000	4006885... ...404205	1 ceiling support	205 x 80 mm



- useful aid for lifting the plasterboards on the wall and joining them with the integrated hook
- completely made of metal, with broad resting surface
- version: with hook
- packaging: sticker

article no.	EAN	description	product dimensions
4045000	4006885... ...404502	1 board lifter	75 x 215 x 65 mm

8 PROJECT THEMES

8.2 Processing plasterboards



The tools and clamps for convenient, easy and safe installation work on walls, ceilings and especially on inclined areas. The fixing clamps and crosses can be removed after the board has been fastened with screws.



- for fixing up to two plasterboards on ceilings and slanted walls and then fastening them in place
- for safe and precise installation
- for installing plasterboards with just one person
- replaces one to two hands needed for holding
- permits effortless and safe working
- reusable
- content:
 - 1 fixing clamp, metal
 - 3 crosses, plastic material
 - 1 bit, Pozidriv PZ 2
 - 3 wood screws, 4 x 60 mm
- packaging: sliding blister

article no.	EAN	description
4040000	4006885... ...404007	1 fixing set

Fastening



- series Solid
- For plasterboard screws 3.5 - 3.9 mm
- durable and robust quality
- version: Phillips PH 2D
- packaging: blister on card
- suitable for 4055000

article no.	EAN	description	shank	length
4053000	4006885... ...405301	2 special bits Solid	hexagon shank 1/4" (6,35 mm)	25 mm



- plastic cap allows direct "view" at the bit and the screw
- screwing depth adjustable
- version: with magnet and depth stop
- including: 1 bit, Phillips PH 2
- packaging: blister on card
- separate accessories: 4053000

article no.	EAN	description	receptacle	length
4055000	4006885... ...405509	1 screwdriver attachment	6,3 mm (1/4") hexagon receptacle	65 mm

8.2 Processing plasterboards

Smoothing



blade edges with special design to fit the curves of the mug

- 2-component handle with soft zone
- blade edges with special design to fit the curves of the mug
- flexible steel blade
- rust-proof
- packaging: sticker

article no.	EAN	description	version	product dimensions
4051000	4006885... ...405103	1 professional scraper	50 mm blade	50 x 210 x 25 mm



- 2-component handle with soft zone
- flexible steel blade
- rust-proof
- including: 1 PH 2 bit for tightening screws
- packaging: sticker

article no.	EAN	description	version	product dimensions
4047000	4006885... ...404700	1 professional taping knife	150 mm blade	150 x 255 x 29 mm



- for professional filling and high-quality joints
- effective and convenient over large surfaces thanks to the extra wide blade
- flexible blade made of stainless steel
- easy to clean handle
- receptacle made from strong aluminium extruded profile
- packaging: bulk

article no.	EAN	description	version
4062000	4006885... ...406209	1 surface scraper	200 mm blade
4063000	4006885... ...406308	1 surface scraper	250 mm blade

8.2 Processing plasterboards



- for professional filling of transitions and joints
- ideal for drywall installation
- stainless steel blade 300 x 130 mm
- wider material application thanks to large, stainless steel blade
- good stability thanks to long rib
- ergonomic 2-component handle for comfortable guiding
- easy to clean
- packaging: bulk

article no.	EAN	description
4043000	4006885... ...404304	1 smoothing trowel



- for inserting self-mixed joint sealant into corners and hard-to-reach places
- maintenance-friendly alternative to acrylic caulk
- protects joint sealant against drying out, enables it to be used again later
- volume: 310 ml
- packaging: plastic bag on card



article no.	EAN	description	product dimensions
4044000	4006885... ...404403	3 empty cartridges	49 x 230 x 49 mm

PROJECT THEMES 8

8.2 Processing plasterboards

Sanding



- for easy fix sanding pads
- for efficient sanding of plasterboard on walls and ceilings
- permits working away from dust with the optional telescopic handle
- stable on the surface for a continuous, fast sanding process
- does not fold down
- easy-fix system for fast changing of the abrasive
- including:
 - 1 easy fix sanding pad silicium-carbide, grain 120
 - 1 ceiling holder
- packaging: paperboard card
- separate accessories: 2287000, 2288000, 4012000, 5617000

article no.	EAN	description	Ø
4052000	...405202	1 surface sander	Ø 225 mm



- with adapter - also suitable for paint rollers
- telescopic from 1.2 to 2 m
- packaging: sticker
- suitable for 4052000

article no.	EAN	description
4012000	...401204	1 telescopic handle

8 PROJECT THEMES

8.2 Processing plasterboards



- especially for fine canvas sized 115 x 280 mm
- 2-component handle with soft zone
- serrated holders for fixing the abrasive safely and permanently
- including: 1 grit cloth, grain 120, 115 x 280 mm
- packaging: paperboard card
- separate accessories: 1988000, 1996000, 4057000, 4058000, 8406600



article no.	EAN	description	product dimensions
4056000	4006885... ...405608	1 hand-held sander	105 x 218 x 90 mm



- content:
 - 1 dust extraction plate
 - 1 spiral hose, 3 m
 - 1 adapter for vacuum cleaners, with supply air control
- packaging: folding box
- suitable for 4056000



article no.	EAN	description
4057000	4006885... ...405707	1 accessory set



- with adapter - also suitable for paint rollers
- telescopic from 1.2 to 2 m
- including: 1 ceiling holder
- packaging: sticker
- suitable for 4056000

article no.	EAN	description
4058000	4006885... ...405806	1 telescopic handle

8.2 Processing plasterboards



- for smoothing joint welds
- for breaking the edges of plasterboards, fibrous plasterboards, porous concrete etc...
- content:
 - 1 clamping handle
 - 4 grit cloths, grain 120, 220, 280 x 115 mm
- packaging: paperboard card
- separate accessories: 1988000, 1996000, 8406600

article no.	EAN	description	product dimensions
8722000	4006885... ...872202	1 hand sander set	110 x 232 x 80 mm

Installation



- for determining the precise position of socket holes in hollow walls
- suitable for all common socket combinations
- precise plumbing thanks to horizontal and vertical levels
- for straightforward setting of marks for the standardised spacings (57, 71 and 91 mm)
- integrated scale for measuring distances, e.g. between a switch and the door frame
- packaging: fixed on card
- complementary products: 2157000, 2158000, 3777000

article no.	EAN	description	product dimensions
4050000	4006885... ...405004	1 template	50 x 185 x 15 mm

8 PROJECT THEMES

8.2 Processing plasterboards

Accessories



Tape & zip door - keeps dirt at low level!

- matching nearly every door
- to restrict the dust formation in the working area
- content:
 - 1 extra strong (100 µm) foil, 2,20 x 1,25 m
 - 1 the self adhesive zipper affords the flexible and re-closable access to working area and the exit out of it in the same way
 - 1 strong adhesive tape for an almost perfect sealing of the door frame and its removal almost without residues
- packaging: plastic bag recloseable

article no.	EAN	description	product dimensions
4005000	4006885... ...400504	1 tape & zip door	1,250 x 2,200 mm

PROJECT THEMES 8
8.3 Firewood



8 PROJECT THEMES

8.3 Firewood

robust & sturdy
1 saw buck



You will be able to fill a whole wheelbarrow with only two or three cuts without having to stop the chain saw.



- very quick - a wheelbarrow full of wood
- stability thanks to wide feet and a 26 mm round tube
- with anti-throw-off locking mechanism
- wooden boards to prevent the chain from getting damaged
- also useable for single wooden pieces
- can be folded for space-saving storage
- packaging: covering box
- complementary products: 2175000

Technical data

application: sawing 1 m long logs fast and safely
 max. loading: 150 kg
 miscellaneous: saw marks at 25, 50 and 75 cm (for 25 cm logs) and 33 and 66 cm (for 33 cm logs)
 dimensions mounted: 700 x 1,120 x 675 mm
 dimensions folded: 1,320 x 1,120 x 115 mm

article no.	EAN	description	weight
5121000	4006885... ...512108	1 saw buck	10.5 kg

PROJECT THEMES 8

8.3 Firewood

portable & compact
1 SB 60 - saw buck



- fast, safe sawing of 1-metre logs to a length of 25 or 33 cm
- stop bar prevents danger from pieces of wood flying out
- practical folding mechanism for swift assembly and dismantling
- portable product with low intrinsic weight but very high stability
- beech boards prevent injury from sawing mishaps
- packaging: covering box

Technical data

max. loading: 100 kg
 dimensions mounted: 540 x 1,000 x 600 mm
 dimensions folded: 540 x 1,100 x 230 mm

article no.	EAN	description	weight
5119000	4006885... ...511903	1 SB 60 - saw buck	4.6 kg

8 PROJECT THEMES

8.3 Firewood



- for storing logs sizes 25 - 50 cm
- its modularity enables it to be used in any situation
- four extension units, each with a length of 425 mm, allow the unit to be built in various heights and widths
- quick assembly and dismantling without tools
- 5 plastic spacers provide optimal ventilation for the wood from the bottom
- ideal for outdoor use
- can be loaded up to a height of 1.4 m or a width of 3.2 m, for a maximum of 1.6 m³ of wood
- packaging: covering box
- dimensions mounted: 1,766 - 3,241 x 1,036 - 1,460 x 256 mm

article no.	EAN	description	weight
5125000	4006885... ...512504	1 modular XXL stacking aid	8 kg



The practical stacking aid for storing logs can be adapted to the individual conditions on site.

- for storing logs sizes 25 - 50 cm
- four plastic spacers provide optimal ventilation for the wood from the bottom
- ideal for outdoor use
- can be extended from 1.72 m to 2.34 m in no time
- can be loaded up to a height of 1.0 m and a width of 2.34 m, for a maximum of 1.17 m³ of wood
- packaging: covering box
- dimensions mounted: 1,720 - 2,340 x 1,045 x 310 mm

article no.	EAN	description	weight
5122000	4006885... ...512207	1 stacking aid	7.5 kg

PROJECT THEMES 8

8.3 Firewood



- for long-time covering of wood
- extra strong tarpaulin (210 g/m²)
- reinforced border
- water-resistant
- tear-resistant
- UV-resistant
- material: woven fabric
- aluminium eyes approx. every 50 cm
- packaging: plastic bag recloseable

article no.	EAN	description	product dimensions	weight
5124000	4006885... ...512405	1 tarpaulin for wood	6,000 x 1,500 mm	1.7 kg



- determines the wood moisture in percent in a fast and easy way
- the two electrodes are pushed in the wood surface and the LCD display shows the percentage of residual moisture
- version: with LCD display
- measuring range: 10 - 40 %
- only suitable for measuring firewood
- including: 1 battery 9 V
- packaging: sliding blister



article no.	EAN	description	product dimensions	weight
8732500	4006885... ...873254	1 wood moisture meter	69 x 127 x 28 mm	0.12 kg

8 PROJECT THEMES
8.4 Processing elastic sealants



8.4 Processing elastic sealants

1 MG 600 - caulking gun "PRO"



The professional gun for maximum power transmission

- for all 310 ml cartridges (Ø 50 x 225 mm)
- for silicone, acrylic, adhesives, special sealants, construction chemistry, Bitumen
- 280 kg pushing pressure for professionally applying all materials from silicone to the most viscous sealants and bitumen
- extra-sturdy design for continuous use
- fatigue-free working thanks to powerful feed mechanism
- easily accessible shell for 310 ml cartridges makes insertion and changing easier
- packaging: paperboard card

article no.	EAN	description	product dimensions
4356000	4006885... ...435605	1 MG 600 - caulking gun "PRO"	391 x 181 x 72 mm

8.4 Processing elastic sealants



The strong and versatile gun

- for all 310 ml cartridges (Ø 50 x 225 mm)
- for silicone, acrylic, adhesives, special sealants
- switchable force booster for a maximum pushing pressure of 220 kg – ideal for applying viscous special sealant and adhesive
- the automatic drip-stop function is active when the switchable force booster is not required and prevents undesired oozing of the material for cleaner results
- powerful feed mechanism for effortless and fatigue-free working
- 360° rotating cartridge case permits screwing into the best working angle
- semi-open shell for easy cartridge changes
- ladder hook for practical hanging on the ladder
- packaging: fixed on card



article no.	EAN	description	product dimensions
4358000	4006885... ...435803	1 MG 550 - caulking gun	387 x 171 x 64 mm



Ergonomic gun with gripping distance adjustment

- for all 310 ml cartridges (Ø 50 x 225 mm)
- for silicone, acrylic, adhesives
- 180 kg pushing pressure for effortlessly applying silicone, acrylic and adhesive from 310 ml cartridges
- gripping distance can be individually adapted to the hand size, for best ergonomics
- ergonomic 2-component handle for fatigue-free working
- 360° rotating cartridge case permits screwing into the best working angle
- semi-open shell for easy cartridge changes
- automatic drip-stop function prevents undesired oozing of the material for cleaner results
- ladder hook for practical hanging on the ladder
- packaging: fixed on card



article no.	EAN	description	product dimensions
4354000	4006885... ...435407	1 MG 400 - caulking gun "ERGO"	387 x 171 x 64 mm

8.4 Processing elastic sealants



The powerful caulking gun

- for all 310 ml cartridges (Ø 50 x 225 mm)
- for silicone, acrylic, adhesives
- 180 kg pushing pressure for effortlessly applying silicone, acrylic and adhesive from 310 ml cartridges
- 360° rotating cartridge case permits screwing into the best working angle
- ergonomic 2-component handle for fatigue-free working
- semi-open shell for easy cartridge changes
- automatic drip-stop function prevents undesired oozing of the material for cleaner results
- packaging: bulk

article no.	EAN	description	product dimensions
4353000	4006885... ...435308	1 MG 350 - caulking gun	398 x 171 x 64 mm



The space-saving compact gun

- for all 310 ml cartridges (Ø 50 x 225 mm)
- for silicone, acrylic, adhesives
- lightweight and compact – fits into even the smallest toolbox
- quick change holder for fast insertion and changing of 310 ml cartridges
- 160 kg pushing pressure for applying silicone, acrylic and adhesive
- 360° rotating cartridge case permits screwing into the best working angle
- ergonomic 2-component handle for fatigue-free working
- automatic drip-stop function prevents undesired oozing of the material for cleaner results
- packaging: fixed on card

article no.	EAN	description	product dimensions
4357000	4006885... ...435704	1 MG 310 - caulking gun "Compact"	351 x 176 x 88 mm

8.4 Processing elastic sealants



standard press with comfort extras

- for all 310 ml cartridges (Ø 50 x 225 mm)
- for silicone, acrylic
- 130 kg pushing pressure for applying silicone and acrylic from 310 ml cartridges with ease
- rotating cartridge case permits screwing into the best working angle
- ergonomic 2-component handle for fatigue-free working
- semi-open shell for easy cartridge changes
- automatic drip-stop function prevents undesired oozing of the material for cleaner results
- packaging: bulk

article no.	EAN	description	product dimensions	weight
4352000	4006885... ...435209	1 MG 200 - caulking gun	350 x 175 x 65 mm	0.366 kg



standard press for hobby and household use

- for all 310 ml cartridges (Ø 50 x 225 mm)
- for silicone, acrylic
- 130 kg pushing pressure for applying silicone and acrylic from 310 ml cartridges with ease
- semi-open shell for easy cartridge changes
- automatic drip-stop function prevents undesired oozing of the material for cleaner results
- packaging: bulk

article no.	EAN	description
4351000	4006885... ...435100	1 MG 100 - caulking gun

8.4 Processing elastic sealants

Accessories



- for safely opening plastic cartridges
- for trimming the cartridge tip to the required length and angle
- with two cutting edges
- packaging: sliding blister

article no.	EAN	description	
4363000	4006885... ...436305	1 KM 100 - cartridge knife	



- for all 280, 290, 300 and 310 ml plastic cartridges (coarse thread)
- sealable cartridge tip
- slows down the rate at which the cartridge contents dry out
- packaging: plastic bag on card

article no.	EAN	description	product dimensions
4365000	4006885... ...436503	4 cartridge tips with closable caps	120 mm



- for all 280, 290, 300 and 310 ml plastic cartridges (coarse thread)
- rotatable angle from 0 - 90° for working in inaccessible places
- packaging: plastic bag on card

article no.	EAN	description
4366000	4006885... ...436602	2 angled cartridge tips

8.4 Processing elastic sealants



- for silicone, acrylic
- practical smoother set contains 5 smoothers for all common radii and chamfers
- edge profiles: 90°/45° - 5, 8, 10, 16 mm/round 3, 6, 8, 10, 15 mm
- narrow geometry for use in tight work areas and spaces
- storage clip allows fanning or individual removal of a smoother
- sturdy and easy to clean thanks to high quality PP plastic
- packaging: sliding blister

article no.	EAN	description
4332000	4006885... ...433205	1 joint smoother set 5 part



- for silicone, acrylic
- set with 2 joint smoothers with smoother profiles for all common widths, radii and chamfers
- edge profiles: 45° - 5, 8, 10 mm/round 5, 8, 10 mm
- elastic TPU plastic for optimum smoothness and easy cleaning
- sturdy and durable for long life
- packaging: sliding blister

article no.	EAN	description
4331000	4006885... ...433106	1 joint smoother set, 2 parts

8.4 Processing elastic sealants



- for silicone, acrylic
- set with 4 joint smoothers with smoother profiles for all common widths, radii and chamfers
- edge profiles: 90°/45° - 5, 6, 8, 10 mm/round 5, 8, 10, 12 mm
- 2 special smoothers for tight spaces, 2 standard smoothers
- elastic TPU plastic for optimum smoothness and easy cleaning
- sturdy and durable for long life
- including manual for perfect work results
- including storage box for order and overview
- packaging: sliding blister

article no.	EAN	description
4330000	4006885... ...433007	1 joint smoother set 4 part



- for silicone, acrylic
- for clean, smooth joints
- easy to clean
- for most edges and radii
- 45° edge profile: width 6 - 8 - 10 - 12 - 15 mm, round profile: R 7 - 10.5 - 14.5 mm
- packaging: sliding blister

article no.	EAN	description
4369000	4006885... ...436909	1 SP 100 - joint smoother set 4 part

8 PROJECT THEMES

8.4 Processing elastic sealants



The inexpensive set for removing and smoothing old and mouldy elastic joints.

- joint knife for quick and simple removing of old silicone or acrylic joints
- Joint smoother for quick and precise smoothing of the new caulk bead
- content:
 - 1 joint smoother
 - 1 joint knife
 - 4 smoother profiles, round \varnothing 8 + 12 mm, oblique 5 + 10 mm
- packaging: blister on card

article no.	EAN	description	
4364000	4006885... ...436404	1 joint repair kit	



- for tile joints (mortar) 2,5 - 6 mm
- depending on joint width one or two carbide tipped blades can be used
- the integrated roll stabilizes the lead in the joint and reduces the risk of damage to neighboring tiles
- easy changing of the TCT blades
- packaging: blister on card
- separate accessories: 5571000

article no.	EAN	description	product dimensions
5570000	4006885... ...557010	1 joint scraper	31 x 44 x 215 mm



- packaging: blister on card
- suitable for 5570000

article no.	EAN	description
5571000	4006885... ...557109	2 replacement blades for joint scraper

8.4 Processing elastic sealants



- for backfilling excessively deep joining and expansion gaps before sealing with elastic sealants
- high elasticity
- water-resistant
- prevent three-point adhesion
- saves sealant
- material: polyethylene foam (PE)
- packaging: plastic bag on card

article no.	EAN	description	Ø	miscellaneous	length
4360000	...436008	1 joint filler profile	Ø 10 mm	for joint widths from 5 - 8 mm	6 m
4361000	...436107	1 joint filler profile	Ø 15 mm	for joint widths from 8 - 12 mm	6 m
4362000	...436206	1 joint filler profile	Ø 20 mm	for joint widths from 12 - 16 mm	6 m

8 PROJECT THEMES

8.5 Wooden deck construction



PROJECT THEMES

8.5 Wooden deck construction

8

Substructure

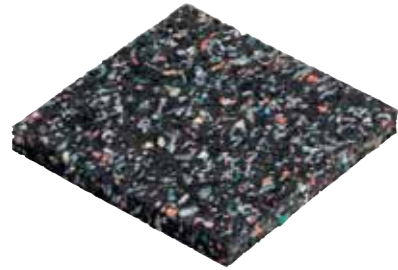

The constructive measure to preserve the wood

The support pads will protect the wood against moisture, thus extending the lifetime of the deck flooring.

- support points for the substructure
- the pads create a distance between foundation and deck joists
- prevent waterlogging and thus the wood from premature rotting
- packaging: plastic card

article no.	EAN	description	product dimensions
6987000	4006885... ...698703	20 support pads	90 x 10 x 90 mm

Boards alignment



The installation clamp is indispensable for aligning the deck boards speedily and precisely.

- precise alignment of the deck boards until they have been fastened
- for deck boards with a width of up to 20 cm
- ensures together with the spacers a clean and accurate pattern of the deck flooring
- including: 2 clamping jaws, for being used with installation clamp as one-hand clamp
- packaging: plastic card

article no.	EAN	description	clamping pressure	clamping width
6985000	4006885... ...698505	1 installation clamp	120 kg	450 mm

8.5 Wooden deck construction



- for uniform expansion gaps between the deck boards
- for expansion gaps of 6 and 8 mm
- ensures together with the installation clamp a clean and accurate pattern of the deck flooring
- packaging: plastic bag on card

article no.	EAN	description	product dimensions
6986000	4006885... ...698604	10 spacers	40 x 42 x 33 mm

Visible connections



- plastic cap allows direct "view" at the bit and the screw
- screwing depth adjustable
- includes stainless steel TX bit – prevents the screw heads from rusting
- including: 1 bit stainless steel, Torx TX 25
- packaging: double blister

article no.	EAN	description	version
6961000	4006885... ...696105	1 magnetic bit holder	with magnet and and depth stop

8.5 Wooden deck construction



The deck drilling set guarantees an accurate and constant screw layout.

- for the precise positioning of the drill holes on the deck boards
- for aligning the drill holes accurately
- easily aligned with the screws of the previous boards
- adjustable for deck boards with widths from 100 - 145 mm
- thanks to the depth stop perfect for series drilling; always the same depth of the countersink
- content:
 - 1 deck board drilling guide, with 4 mm drill bushes made of hardened steel for guiding the drill safely
 - 1 screw starter, with countersink and 4 mm HSS drill
- packaging: double blister

article no.	EAN	description
6960000	4006885... ...696006	1 deck flooring drilling set

8.5 Wooden deck construction

Invisible connections

Concealed fastening - the new wolcraft joining system for wood decks. For highest demands regarding look and durability.

1 starter kit "concealed fastening"



- create a distance between deck boards and deck joists
- guarantee an optimal airing between deck boards and deck joists
- prevent waterlogging and thus the wood from premature rotting
- for approx. 7 running meters of deck joists as substructure for 140 mm deck boards
- suitable for deck boards with a width ranging between 100 and 150 mm
- no visible screws any more
- the movement zone of the deck board joiners compensates the swelling and shrinking movements of the timber - no more sheared screws or cracked deck boards
- fast and simple installation thanks to the drilling and fastening gauge
- content:
 - 1 drill and screw gauge
 - 50 joiners
 - 300 screws, stainless steel, Torx TX 20
 - 1 magnetic bit holder
 - 1 bit, stainless steel, Torx TX 20
- packaging: double blister

article no.	EAN	description
6971000	4006885... ...697102	1 starter kit "concealed fastening"

8.5 Wooden deck construction



The special joiners for the first and last board

The joiners will ensure the clean visual finish of the flooring.

- guarantees the safe installation of the first and last deck board on the visible front side of the deck joists
- including: 60 screws stainless steel, Torx TX 20
- packaging: double blister

article no.	EAN	description
6973000	4006885... ...697300	10 joiners for the first and last board



Expansion kits for concealed fastening

- create a distance between deck boards and deck joists
- guarantee an optimal airing between deck boards and deck joists
- prevent waterlogging and thus the wood from premature rotting
- no visible screws any more
- the movement zone of the deck board joiners compensates the swelling and shrinking movements of the timber - no more sheared screws or cracked deck boards
- packaging: double blister

article no.	EAN	description	including
6972000	4006885... ...697201	20 joiners "Invisible connections"	120 screws stainless steel, Torx TX 20
6974000	...697409	100 joiners "Invisible connections"	600 screws stainless steel, Torx TX 20

8 PROJECT THEMES

8.5 Wooden deck construction

Assortments



Deck building set

The complete kit for fast and precise deck building.

- The installation clamp is indispensable for aligning the deck boards speedily and precisely.
- ensures together with the spacers a clean and accurate pattern of the deck flooring
- for the precise positioning of the drill holes on the deck boards
- for aligning the drill holes accurately
- thanks to the depth stop perfect for series drilling; always the same depth of the countersink
- content:
 - 1 installation clamp
 - 1 deck board drilling guide, with 4 mm drill bushes made of hardened steel for guiding the drill safely
 - 1 screw starter, with countersink and 4 mm HSS drill
 - 5 spacers
 - 2 clamping jaws, for being used with installation clamp as one-hand clamp
- packaging: plastic card



article no.	EAN	description
6988000	4006885... ...698802	1 deck building set

PROJECT THEMES 8
8.6 Laying tiles



8.6 Laying tiles

Cutting tiles

Innovative cutting technology - once adjusted and always perfect cuts

1 TC 670 - tile cutter "Expert"



special guide for diagonal cutting



breaking point for straight cuts



low-maintenance and precise guidance by groove ball bearings and c-section rails



- Perfect result in three steps: - once adjusted tile thickness and surface pressure - smooth continuous cut - easy breaking without much effort
- low-maintenance and precise guidance by groove ball bearings and c-section rails
- special guide for diagonal cutting
- stable and rigid base plate made of aluminium profile
- free view on the cutting process
- suitable for right and left-handed
- cutting wheel made of tungsten-carbide & TiN, Ø 20 mm, bore 5 mm
- cutting length: 670 mm
- tile thickness: 4-14 mm
- including:
 - 1 guide rail with angle fence, for repeat and diagonal cuts
 - 2 material supports, attachable to base plate
- packaging: covering box
- separate accessories: 5551000, 5552000, 5556000

article no.	EAN	description	product dimensions	weight
5555000	4006885... ...555501	1 TC 670 - tile cutter "Expert"	530 x 305 x 1,015 mm	6.14 kg

PROJECT THEMES 8

8.6 Laying tiles

Innovative cutting technology - once adjusted and always perfect cuts
 1 TC 670 - tile cutter "Project"



- Perfect results for batch cutting - only set tile thickness and pressure once!
- low-maintenance and precise guiding through plastic slide and C-profile rails
- special guide for diagonal cutting
- stable and rigid base plate made of aluminium profile
- free view on the cutting process
- suitable for right and left-handed
- cutting wheel made of tungsten-carbide, Ø 20 mm, bore 5 mm
- cutting length: 670 mm
- tile thickness: 4-14 mm
- including:
 - 1 guide rail with angle fence, for repeat and diagonal cuts
 - 2 material supports, attachable to base plate
- packaging: covering box
- separate accessories: 5551000, 5552000, 5556000

article no.	EAN	description	product dimensions	weight
5550000	4006885... ...555006	1 TC 670 - tile cutter "Project"	530 x 400 x 1,015 mm	5.82 kg

8 PROJECT THEMES

8.6 Laying tiles



Professional tile cutting with innovative breaking technology



- robust and low-maintenance c-section guidance for clear and smooth scoring of tiles
- spring-loaded and non-slip, easy to clean load-bearing areas ensure an optimal breaking result
- heavy, non-slip and rigid metal design
- ergonomic handle
- cutting wheel made of tungsten-carbide, Ø 20 mm, bore 5 mm
- cutting length: 710 mm
- tile thickness: 3-14 mm
- including:
 - 1 guide rail with angle fence, for repeat and diagonal cuts
 - 1 cutting wheel made of tungsten-carbide, Ø 20 mm, bore 5 mm
- packaging: covering box
- separate accessories: 5551000, 5556000

article no.	EAN	description	product dimensions	weight
5565000	4006885... ...556508	1 TC 710 PM - tile cutter	255 x 125 x 930 mm	11.3 kg



Traditional-style cutting and breaking of tiles

- heavy, solid and stable design
- base plate manufactured from 18 mm multiplex
- smooth, clean cuts achieved thanks to a 20 mm cutting wheel and a c-section guide with low-maintenance ball bearings
- movable breaking wedge for breaking of tiles can be retracted when working on the base plate
- cutting length: 710 mm
- tile thickness: 3-14 mm
- including:
 - 1 guide rail with angle fence, for repeat and diagonal cuts
 - 1 cutting wheel made of tungsten-carbide, Ø 20 mm, bore 5 mm
- packaging: covering box
- separate accessories: 5551000, 5556000

article no.	EAN	description	product dimensions	weight
5553000	4006885... ...555303	1 TC 710 PW - tile cutter	255 x 125 x 930 mm	10.5 kg

PROJECT THEMES 8

8.6 Laying tiles



Compact tile cutter on wooden base plate

- simple cutting of tiles, thanks to the c-section rails and two triple ball bearings
- integrated metal cone facilitates tile breaking
- perfect repeat and diagonal cuts thanks to the guide rail with stop
- stable, robust design on wooden base
- cutting length: 610 mm
- tile thickness: 3-10 mm
- including:
 - 1 guide rail with angle fence, for repeat and diagonal cuts
 - 1 cutting wheel made of tungsten-carbide (TC), Ø 15 mm, bore 6.1 mm
- packaging: covering box
- separate accessories: 5557000

article no.	EAN	description	product dimensions	weight
5561000	4006885... ...556102	1 TC 610 W - tile cutter	250 x 120 x 795 mm	5.5 kg



- easy cutting: sliding cutting process for a continuous scoring pattern
- easy breaking: due to two cone tips (45° and 90 °)
- low-maintenance and precise guidance by synthetic plain bearings and oval rails
- stable and rigid base plate made of aluminium profile
- free view on the cutting process
- suitable for right and left-handed
- cutting wheel made of tungsten-carbide (TC), Ø 15 mm, bore 6.1 mm
- cutting length: 600 mm
- tile thickness: 4-10 mm
- including:
 - 1 stop rail, for repeat and diagonal cuts
 - 2 material supports, attachable to base plate
- packaging: covering box
- separate accessories: 5557000

article no.	EAN	description	product dimensions	weight
5558000	4006885... ...555808	1 TC 600 - tile cutter	240 x 240 x 780 mm	2.16 kg

8 PROJECT THEMES

8.6 Laying tiles



- easy cutting: sliding cutting process for a continuous scoring pattern
- easy breaking: due to two cone tips (45° and 90 °)
- low-maintenance and precise guidance by synthetic plain bearings and oval rails
- stable and rigid base plate made of aluminium profile
- free view on the cutting process
- suitable for right and left-handed
- cutting wheel made of tungsten-carbide (TC), Ø 15 mm, bore 6.1 mm
- cutting length: 460 mm
- tile thickness: 4-10 mm
- including:
 - 1 guide rail with angle fence, for repeat and diagonal cuts
 - 2 material supports, attachable to base plate
- packaging: covering box
- separate accessories: 5557000

article no.	EAN	description	product dimensions	weight
5559000	4006885... ...555907	1 TC 460 - tile cutter	240 x 240 x 640 mm	1.72 kg



- for cutting long tiles on tile cutters from the TC 670 series
- large contact surface enables straight cuts and angle cuts of up to 10° for wall levelling
- easy assembly
- max. cutting width: 300 mm
- angle cuts up to max. 10°
- cutting length: 670 mm
- adjustment of parallelism at a minimum of two measuring points using a separate measuring instrument
- packaging: folding box
- suitable for 5550000, 5555000

article no.	EAN	description
5552000	4006885... ...555200	1 parallel stop

PROJECT THEMES 8

8.6 Laying tiles



- material: Tungsten Carbide
- bore \varnothing 6.1 mm
- packaging: blister on card
- suitable for 5558000, 5559000, 5561000



article no.	EAN	description	\varnothing
5557000	4006885... ...555709	1 cutting wheel	\varnothing 15 mm



- bore \varnothing 5 mm
- packaging: blister on card
- suitable for 5550000, 5553000, 5555000, 5565000



article no.	EAN	description	material	\varnothing
5551000	4006885... ...555105	1 cutting wheel	Tungsten Carbide, TIN coated	\varnothing 20 mm
5556000	...555600	1 cutting wheel	Tungsten Carbide	\varnothing 20 mm

8.7 Door and door frame fitting



8.7 Door and door frame fitting



10

Door frame jig "Easy"

- supports the frame during foam filling and ensures sides are parallel
- firmly attached to the door frame: supports it during fitting and facilitates alignment
- for all doors with a width of 600 - 1000 mm
- packaging: paperboard card

article no.	EAN	description
3675000	4006885... ...367500	1 door frame jig "Easy"



10

Door frame assembly set "Pro"

The complete set for fitting a door frame.

- fitting and alignment of the door frame in just a few steps
- the frame is precisely aligned vertically and horizontally, and fixed into place
- supports the door frame perfectly during foam filling
- for all doors with a width of 600 - 1000 mm
- content:
 - 2 door frame jigs "PRO"
 - 2 door frame aligning clamps "PRO"
 - 4 shims
 - 1 manual
- packaging: covering box

article no.	EAN	description
3676000	4006885... ...367609	1 door frame assembly set "PRO"

Art. No.	PG	Page	Art. No.	PG	Page	Art. No.	PG	Page	Art. No.	PG	Page	Art. No.	PG	Page	Art. No.	PG	Page
1000000	6.12	327	1321099	6.3	164	1627099	6.14	344	1794000	6.4	203	1983000	6.4	193			
1001000	6.3	176	1322000	6.3	164	1628099	6.14	345	1811000	6.4	201	1986200	6.4	193			
1002000	6.12	316	1322099	6.3	164	1629099	6.14	345	1812000	6.4	201	1987000	6.4	196			
1003000	6.2	133	1323000	6.3	164	1630099	6.14	345	1813000	6.4	201	1988000	6.4	197			
1120000	6.4	190	1323099	6.3	164	1631099	6.14	345	1814000	6.4	201	1990000	6.4	193			
1121000	6.4	190	1324000	6.3	164	1633099	6.14	343	1826000	6.4	199	1992000	6.4	191			
1122000	6.4	190	1324099	6.3	164	1651000	6.14	349	1830000	6.4	198	1993000	6.4	191			
1123000	6.4	190	1325000	6.3	164	1660999	6.14	345	1838000	6.4	182	1994000	6.4	191			
1124000	6.4	190	1325099	6.3	164	1663000	6.14	346	1840000	6.4	182	1996000	6.4	197			
1125000	6.4	201	1326000	6.3	164	1664000	6.14	346	1841000	6.4	182	1997000	6.4	196			
1127000	6.4	201	1326099	6.3	164	1668999	6.14	343	1842000	6.4	182	1998000	6.4	191			
1128000	6.4	201	1327000	6.3	164	1669999	6.14	343	1843000	6.4	182	2000000	6.4	214			
1129000	6.4	201	1327099	6.3	164	1672000	6.4	210	1850000	6.4	198	2001000	6.4	214			
1150000	6.4	180	1328099	6.3	164	1673000	6.4	210	1850100	6.4	198	2002000	6.4	214			
1150100	6.4	180	1329099	6.3	164	1674000	6.4	215	1851000	6.4	198	2003000	6.4	214			
1151000	6.4	180	1330000	6.3	154	1683999	6.14	343	1851100	6.4	198	2015000	6.4	206			
1152000	6.4	180	1330099	6.3	154	1684999	6.14	343	1852000	6.4	198	2016000	6.4	206			
1152100	6.4	180	1331000	6.3	154	1685999	6.14	343	1852100	6.4	198	2017000	6.4	206			
1153000	6.4	180	1331099	6.3	154	1686999	6.14	344	1853000	6.4	199	2020000	6.4	214			
1153100	6.4	180	1332000	6.3	154	1687999	6.14	343	1853100	6.4	199	2025000	6.4	231			
1156100	6.4	180	1332099	6.3	154	1688999	6.14	344	1854000	6.4	199	2027000	6.4	206			
1157000	6.4	180	1333000	6.3	154	1694000	6.14	348	1857000	6.4	199	2027099	6.4	206			
1160000	6.4	199	1333099	6.3	154	1695000	6.14	348	1861000	6.4	188	2028000	6.4	206			
1161000	6.4	199	1334000	6.3	154	1698000	6.14	348	1862000	6.4	188	2028099	6.4	206			
1162000	6.4	199	1334099	6.3	154	1700099	6.10	289	1863000	6.4	188	2029000	6.4	206			
1163000	6.4	199	1335000	6.3	154	1702000	6.10	291	1864000	6.4	188	2029099	6.4	206			
1167000	6.4	199	1335099	6.3	154	1703000	6.10	291	1865100	6.4	199	2032000	6.4	215			
1189000	6.4	201	1338000	6.3	154	1704099	6.10	289	1866000	6.4	199	2033000	6.4	215			
1209000	6.3	155	1339000	6.3	155	1705000	6.10	290	1869000	6.4	184	2034000	6.4	215			
1210000	6.3	155	1340000	6.3	155	1705099	6.10	289	1890000	6.4	187	2035000	6.4	215			
1211000	6.3	155	1342000	6.3	159	1706000	6.10	290	1890100	6.4	188	2036000	6.4	215			
1212000	6.3	155	1344000	6.3	159	1706099	6.10	289	1892000	6.4	187	2037000	6.4	215			
1213000	6.3	155	1369000	6.3	156	1707000	6.10	290	1894000	6.4	188	2038000	6.4	216			
1216000	6.3	157	1372000	6.3	156	1708000	6.10	290	1896000	6.4	188	2039000	6.4	216			
1235000	6.3	168	1374000	6.3	156	1710000	6.10	291	1897000	6.4	188	2048000	6.4	194			
1236000	6.3	168	1375000	6.3	175	1715000	6.4	185	1899100	6.4	186	2049000	6.4	194			
1237000	6.3	169	1376000	6.3	175	1717000	6.4	185	1900000	6.4	185	2052000	6.4	194			
1239000	6.3	167	1378000	6.3	175	1719000	6.4	185	1902000	6.4	185	2053000	6.4	194			
1240000	6.3	167	1379000	6.3	175	1724000	6.4	184	1904000	6.4	185	2054000	6.4	194			
1241000	6.3	162	1380000	6.3	175	1725000	6.4	184	1906000	6.4	186	2056000	6.4	195			
1242000	6.3	162	1383000	6.3	175	1726000	6.4	184	1908000	6.4	186	2057000	6.4	195			
1244000	6.3	162	1384000	6.3	175	1739000	6.4	223	1912000	6.4	186	2058000	6.4	195			
1245000	6.3	162	1386000	6.3	160	1740000	6.4	223	1914000	6.4	186	2059000	6.4	195			
1247000	6.3	162	1388000	6.3	158	1741000	6.4	223	1916000	6.4	187	2061000	6.4	195			
1248000	6.3	162	1389000	6.3	161	1742000	6.4	223	1916100	6.4	187	2068000	6.4	195			
1249000	6.3	162	1391000	6.3	175	1749000	6.4	190	1918000	6.4	187	2069000	6.4	179			
1250000	6.3	162	1392000	6.3	175	1755000	6.4	203	1919000	6.4	187	2069100	6.4	179			
1252000	6.3	162	1395000	6.3	175	1756000	6.4	202	1920000	6.4	187	2070000	6.4	179			
1253000	6.3	162	1396000	6.3	175	1757000	6.4	202	1922000	6.4	187	2070100	6.4	179			
1260000	6.3	160	1500000	6.5	240	1760000	6.4	203	1923000	6.4	187	2072000	6.4	179			
1261000	6.3	160	1502000	6.5	240	1761000	6.4	192	1932000	6.4	188	2080000	6.4	194			
1262000	6.3	160	1505000	6.5	241	1762000	6.4	190	1933100	6.4	188	2082000	6.4	194			
1263000	6.3	160	1506000	6.5	241	1763000	6.4	202	1934000	6.4	188	2083000	6.4	194			
1264000	6.3	160	1510000	6.5	241	1764000	6.4	202	1936000	6.4	188	2084000	6.4	194			
1265000	6.3	160	1512000	6.5	242	1766000	6.4	190	1938000	6.4	188	2086000	6.4	195			
1266000	6.3	160	1527000	6.3	154	1767000	6.4	190	1940000	6.4	189	2087000	6.4	195			
1267000	6.3	160	1534000	6.3	154	1768000	6.4	190	1944000	6.4	189	2088000	6.4	195			
1268000	6.3	160	1539000	6.3	170	1770000	6.4	224	1946000	6.4	189	2089000	6.4	195			
1269000	6.3	160	1573000	6.3	168	1771000	6.4	224	1950000	6.4	185	2092000	6.4	194			
1296000	6.3	165	1575000	6.3	158	1772000	6.4	224	1954000	6.4	185	2098000	6.4	230			
1297000	6.3	165	1577000	6.3	170	1773000	6.4	224	1956000	6.4	185	2100000	6.5	236			
1298000	6.3	165	1579000	6.3	174	1774000	6.4	224	1959100	6.4	191	2101000	6.5	236			
1299000	6.3	165	1620099	6.14	344	1775000	6.4	224	1961000	6.4	191	2102000	6.5	236			
1302000	6.3	165	1620300	6.14	344	1776000	6.4	224	1962000	6.4	191	2103000	6.5	236			
1303000	6.3	165	1621099	6.14	345	1780000	6.4	200	1963000	6.4	191	2104000	6.5	237			
1304000	6.3	165	1621300	6.14	345	1781000	6.4	200	1966000	6.4	191	2106000	6.5	236			
1305000	6.3	165	1622099	6.14	344	1782000	6.4	200	1968000	6.4	192	2107000	6.5	246			
1306000	6.3	165	1622300	6.14	344	1783000	6.4	200	1969100	6.4	192	2108000	6.5	236			
1307000	6.3	165	1623099	6.14	345	1787000	6.4	200	1971000	6.4	192	2109000	6.5	237			
1315099	6.3	165	1623300	6.14	345	1790000	6.4	203	1972000	6.4	192	2110000	6.5	239			
1317099	6.3	164	1624099	6.14	344	1791000	6.4	203	1973000	6.4	192	2112000	6.5	239			
1319099	6.3	164	1626099	6.14	344	1792000	6.4	203	1981000	6.4	193	2114000	6.5	238			
1320000	6.3	164	1626300	6.14	344	1793000	6.4	203	1982000	6.4	193	2116000	6.4	231			

Art. No.	PG	Page	Art. No.	PG	Page	Art. No.	PG	Page	Art. No.	PG	Page	Art. No.	PG	Page	Art. No.	PG	Page
2117000	6.4	231	2253000	6.4	179	2407000	6.3	161	2530000	6.7	270	2713000	6.5	245			
2119000	6.5	236	2258000	6.4	178	2408000	6.3	161	2531000	6.7	270	2715000	6.5	248			
2125000	6.5	246	2259100	6.4	179	2411000	6.3	171	2532000	6.7	270	2716000	6.5	248			
2126000	6.5	237	2260000	6.4	212	2413000	6.3	176	2533000	6.7	270	2717000	6.5	248			
2127000	6.5	237	2265000	6.5	239	2414000	6.3	174	2534000	6.7	270	2718000	6.5	249			
2128000	6.5	237	2267100	6.4	178	2415000	6.3	174	2535000	6.7	270	2719000	6.5	249			
2130000	6.4	230	2269000	6.4	178	2416000	6.3	155	2536000	6.7	270	2720000	6.5	249			
2131000	6.4	230	2269100	6.4	178	2419000	6.3	169	2540000	6.7	271	2721000	6.5	250			
2132000	6.4	230	2270000	6.4	178	2421000	6.3	170	2542000	6.7	269	2722000	6.5	250			
2133000	6.5	238	2270100	6.4	178	2425000	6.3	171	2544000	6.7	269	2723000	6.5	250			
2134000	6.4	231	2271000	6.4	178	2426000	6.3	170	2545000	6.7	268	2724000	6.5	250			
2138000	6.5	248	2271100	6.4	178	2426099	6.3	170	2546000	6.7	265	2725000	6.5	250			
2139000	6.4	231	2272000	6.4	178	2429000	6.3	172	2547000	6.7	265	2726000	6.5	243			
2140000	6.4	233	2281000	6.4	205	2443000	6.3	154	2548000	6.7	265	2727000	6.5	243			
2141000	6.10	289	2282100	6.4	208	2444000	6.3	159	2555000	6.7	274	2728000	6.5	243			
2142000	6.4	233	2283100	6.4	208	2445000	6.3	159	2576000	6.7	266	2729000	6.5	243			
2144000	6.4	232	2284100	6.4	208	2446000	6.3	159	2577000	6.7	266	2730000	5.1	79			
2146000	6.4	229	2285000	6.4	205	2447000	6.3	155	2578000	6.7	266	2731000	5.1	79			
2147000	6.8	278	2287000	6.4	183	2450000	6.4	205	2580000	6.7	267	2732000	5.1	79			
2148000	6.5	246	2288000	6.4	183	2452000	6.4	205	2581000	6.7	267	2733000	5.1	79			
2149000	6.5	246	2289000	6.1	115	2453000	6.14	353	2582000	6.7	266	2738000	6.5	239			
2150000	6.5	246	2290000	6.1	114	2454000	6.4	205	2583000	6.7	267	2739000	6.5	240			
2151000	6.5	246	2291000	6.1	117	2455000	6.4	209	2584000	6.7	266	2740000	6.5	240			
2153000	6.5	246	2292000	6.1	119	2456000	6.14	352	2585000	6.7	274	2741000	6.5	242			
2154000	6.2	141	2293000	6.1	118	2457000	6.14	353	2603000	6.8	277	2746000	6.5	244			
2155000	6.2	141	2294000	6.1	115	2458000	6.14	353	2606000	6.8	276	2747000	6.5	245			
2157000	6.2	142	2295000	6.1	116	2459000	6.14	353	2618000	6.8	276	2748000	6.5	248			
2158000	6.2	140	2296000	6.1	115	2460000	6.4	209	2623000	6.8	276	2750000	6.5	249			
2160000	6.2	142	2297000	6.1	118	2461000	6.4	209	2625000	6.8	277	2751000	5.1	80			
2161000	6.2	144	2298000	6.1	117	2462000	6.4	209	2630000	6.8	277	2755000	5.1	80			
2162000	6.2	143	2299000	6.1	117	2465000	6.4	209	2631000	6.8	277	2764000	6.5	248			
2164000	6.2	142	2300000	6.1	105	2466000	6.4	209	2632000	6.8	277	2765000	6.5	249			
2165000	6.2	142	2301000	6.1	104	2467000	6.4	209	2635000	6.8	278	2778000	6.4	221			
2169000	6.2	144	2303000	6.1	104	2468000	6.4	209	2640000	6.8	278	2779000	6.4	221			
2170000	6.4	232	2305000	6.1	106	2469000	6.4	209	2641000	6.8	276	2780000	6.4	224			
2171000	6.4	232	2307000	6.1	109	2470000	6.4	209	2642000	6.8	276	2781000	6.4	224			
2172000	6.4	232	2308000	6.1	109	2471000	6.4	209	2645000	6.8	277	2782000	6.4	224			
2173000	6.4	232	2309000	6.1	111	2472000	6.4	209	2649000	6.8	278	2784000	6.4	224			
2174000	6.4	232	2310000	6.1	90	2475000	6.4	209	2650000	6.1	91	2786000	6.4	224			
2175000	6.4	233	2311000	6.1	89	2476000	6.4	209	2651000	6.1	90	2840000	6.4	225			
2177000	6.4	210	2313000	6.1	89	2477000	6.3	155	2652000	6.1	88	2841000	6.4	225			
2178000	6.4	231	2315000	6.1	93	2477099	6.3	155	2653000	6.1	89	2842000	6.4	225			
2179000	6.4	232	2317000	6.1	96	2478000	6.3	155	2654000	6.1	95	2843000	6.4	225			
2200000	6.11	299	2318000	6.1	95	2478099	6.3	155	2655000	6.1	101	2844000	6.4	225			
2202000	6.11	300	2319000	6.1	98	2479000	6.3	155	2669000	6.1	123	2845000	6.4	225			
2207000	6.11	300	2345000	6.1	114	2480000	6.3	155	2671000	6.1	121	2846000	6.4	225			
2208000	6.4	229	2351000	6.1	104	2480099	6.3	155	2672000	6.1	116	2848000	6.4	225			
2211000	6.4	211	2356000	6.1	112	2481000	6.3	155	2673000	6.1	120	2849000	6.4	225			
2213100	6.4	212	2358000	6.1	100	2481099	6.3	155	2674000	6.1	107	2850000	6.4	225			
2214100	6.4	212	2360000	6.1	90	2482000	6.3	155	2677000	6.1	121	2851000	6.4	225			
2215100	6.4	212	2361000	6.1	89	2482099	6.3	155	2678000	6.1	121	2852000	6.4	225			
2216000	6.4	212	2365000	6.1	93	2483000	6.3	155	2679000	6.1	119	2853000	6.4	225			
2217100	6.4	212	2367000	6.1	96	2483099	6.3	155	2680000	6.1	93	2854000	6.4	225			
2218100	6.4	212	2370000	6.1	106	2491000	6.3	155	2681000	6.1	107	2856000	6.4	225			
2219000	6.4	213	2371000	6.1	105	2495000	6.3	155	2682000	6.1	91	2858000	6.4	225			
2220000	6.2	141	2372000	6.1	103	2498000	6.7	268	2683000	6.1	105	2860000	6.4	226			
2223000	6.4	211	2373000	6.1	106	2499000	6.7	268	2684000	6.1	99	2861000	6.4	226			
2224000	6.4	229	2375000	6.1	108	2500000	6.7	268	2685000	6.1	98	2862000	6.4	226			
2225000	6.4	213	2376000	6.1	109	2504000	6.7	264	2688000	6.1	99	2863000	6.4	226			
2227000	6.4	178	2377000	6.1	101	2505000	6.7	264	2689000	6.1	112	2864000	6.4	226			
2228000	5.98	86	2378000	6.1	110	2506000	6.7	264	2690000	6.1	111	2866000	6.4	226			
2230000	6.8	279	2379000	6.1	92	2511000	6.7	268	2691000	6.1	97	2867000	6.4	226			
2241100	6.4	212	2380000	6.1	91	2512000	6.12	331	2692000	6.1	92	2868000	6.4	226			
2242100	6.4	212	2381000	6.1	90	2515000	6.7	274	2695000	6.1	120	2869000	6.4	226			
2243100	6.4	212	2382000	6.1	88	2516000	6.7	274	2696000	6.1	118	2870000	6.4	226			
2245000	6.4	216	2383000	6.1	91	2518000	6.7	273	2700000	6.5	247	2871000	6.4	226			
2246000	6.4	216	2383100	6.1	94	2519000	6.7	273	2701000	6.5	247	2872000	6.4	226			
2249000	6.4	229	2384000	6.1	98	2520000	6.7	272	2702000	6.5	247	2873000	6.4	226			
2250000	6.4	179	2385000	6.1	93	2521000	6.7	272	2704000	6.5	236	2874000	6.4	226			
2250100	6.4	179	2388000	6.1	96	2522000	6.7	273	2705000	6.5	246	2875000	6.4	226			
2251000	6.4	179	2393000	6.1	91	2523000	6.7	272	2709000	6.5	236	2876000	6.4	226			
2251100	6.4	179	2396000	6.1	123	2524000	6.7	273	2710000	6.5	236	2877000	6.4	220			
2252000	6.4	179	2400000	6.3	158	2527000	6.7	270	2711000	6.5	244	2878000	6.4	226			

Art. No.	PG	Page	Art. No.	PG	Page	Art. No.	PG	Page	Art. No.	PG	Page	Art. No.	PG	Page	Art. No.	PG	Page
2879000	6.4	226	3038000	4.1	59	3275000	4.6	69	3475000	6.2	129	3801000	6.9	284			
2887000	6.4	222	3051000	4.10	74	3276000	4.6	69	3476000	6.2	129	3802000	6.9	284			
2891000	6.4	219	3057000	4.3	61	3277000	4.6	69	3477000	6.2	129	3803000	6.9	284			
2892000	6.4	220	3058000	4.3	61	3278000	4.6	69	3478000	6.2	130	3804000	6.9	284			
2894000	6.4	221	3059000	4.3	61	3280000	4.6	70	3490000	6.2	133	3828000	6.9	281			
2895000	6.4	222	3082000	6.3	172	3285000	4.8	72	3491000	6.2	133	3829000	6.9	281			
2896000	6.4	220	3083000	6.3	173	3286000	4.8	72	3492000	6.2	133	3831000	6.9	281			
2897000	6.4	220	3084000	6.3	172	3287000	4.8	72	3493000	6.2	133	3835000	6.16	370			
2898000	6.4	220	3085000	6.3	173	3290000	4.9	73	3494000	6.2	133	3836000	6.16	370			
2899000	6.4	221	3086000	6.3	173	3291000	4.9	73	3498000	6.2	134	3837000	6.16	370			
2900000	6.12	332	3101000	6.4	187	3292000	4.9	73	3537000	6.1	107	3838000	6.16	370			
2905000	5.1	78	3102000	6.4	187	3293000	4.9	73	3538000	6.1	109	3839000	6.16	372			
2906000	5.1	78	3103000	6.4	187	3294000	4.9	73	3541000	6.1	104	3840000	6.16	372			
2907000	5.1	78	3104000	6.4	187	3295000	4.9	73	3543000	6.1	88	3841000	6.16	373			
2908000	5.1	78	3111000	6.4	187	3300000	6.12	314	3544000	6.1	110	3842000	6.16	373			
2909000	5.1	78	3112000	6.4	187	3301000	6.12	314	3545000	6.1	88	3848000	6.16	373			
2910000	5.1	78	3113000	6.4	188	3302000	6.12	314	3546000	6.1	90	3849000	6.16	373			
2911000	5.1	80	3114000	6.4	188	3303000	6.12	314	3547000	6.1	92	3862000	6.2	132			
2912000	5.1	80	3117000	6.4	188	3305000	6.12	314	3548000	6.1	103	3863000	6.9	282			
2913000	5.1	80	3118000	6.4	201	3306000	6.12	314	3549000	6.1	96	3864000	6.16	378			
2916000	5.1	81	3119000	6.4	226	3309000	6.12	316	3550000	6.1	103	3865000	6.16	378			
2917000	5.1	81	3122000	6.4	189	3310000	6.12	316	3551000	6.1	89	3874000	6.2	145			
2918000	5.1	82	3124000	6.4	189	3313000	6.12	315	3554000	6.1	97	3876000	6.2	145			
2920000	5.3	82	3125000	6.4	189	3315000	6.12	315	3555000	6.1	97	3879000	6.2	145			
2921000	5.3	83	3136000	6.4	202	3316000	6.12	315	3559000	6.1	100	3882000	6.2	145			
2922000	5.3	83	3137000	6.4	202	3317000	6.12	315	3561000	6.1	94	3885000	6.2	145			
2923000	5.3	83	3138000	6.4	202	3318000	6.12	315	3566000	6.1	116	3887000	6.2	145			
2924000	5.3	83	3139000	6.4	202	3319000	6.12	315	3567000	6.1	120	3893000	6.2	132			
2928000	5.4	85	3141000	6.4	225	3320000	6.12	315	3568000	6.1	119	3894000	6.2	132			
2933000	5.4	85	3150100	6.4	194	3321000	6.12	315	3599000	6.1	122	3895000	6.2	132			
2939000	5.4	85	3151100	6.4	194	3322000	6.12	315	3605000	4.3	61	3896000	6.2	132			
2940000	5.5	85	3152100	6.4	194	3325000	6.12	315	3606000	4.3	61	3897000	6.2	132			
2941000	5.5	85	3156100	6.4	195	3326000	6.12	315	3607000	4.3	61	3898000	6.2	132			
2942000	5.5	85	3157100	6.4	195	3327000	6.12	315	3610000	4.3	60	3899000	6.2	132			
2943000	5.5	85	3158100	6.4	195	3328000	6.12	315	3611000	4.3	60	3900000	6.9	284			
2944000	5.5	85	3162000	6.4	204	3361000	6.12	314	3612000	4.3	60	3901000	6.9	284			
2945000	5.5	85	3163000	6.4	228	3362000	6.12	314	3615000	4.5	67	3902000	6.9	284			
2949000	5.3	83	3164000	6.4	228	3363000	6.12	314	3616000	4.5	67	3903000	6.9	284			
2960000	6.4	221	3165000	6.4	232	3364000	6.12	314	3620000	4.3	60	3904000	6.9	284			
2961000	6.4	221	3166000	6.4	228	3365000	6.12	314	3621000	4.3	60	3922000	6.9	281			
2962000	6.4	221	3167000	6.4	228	3366000	6.12	314	3622000	4.3	60	3924000	6.9	281			
2963000	6.3	166	3168000	6.4	184	3374000	6.12	314	3623000	4.3	60	3925000	6.9	281			
2964000	6.3	166	3169000	6.4	181	3376000	6.12	314	3625000	4.4	63	3926000	6.9	281			
2965000	6.3	163	3170000	6.4	224	3406000	6.11	294	3626000	4.4	63	3927000	6.9	281			
2969000	6.3	166	3171000	6.4	224	3410000	6.11	295	3629000	4.4	63	3929000	6.16	387			
2974000	6.3	166	3172000	6.4	224	3412099	6.11	295	3630000	4.4	62	3930000	6.16	387			
2975000	6.3	156	3173000	6.4	224	3415000	4.10	74	3631000	4.4	62	3931000	6.9	281			
2976000	6.3	157	3174000	6.4	224	3416000	4.7	71	3632000	4.5	66	3935000	6.16	381			
2977000	6.3	157	3175000	6.4	224	3417000	4.7	70	3633000	4.4	62	3936000	6.16	383			
2978000	6.3	157	3176000	6.4	224	3418000	4.6	69	3634000	4.5	66	3937000	6.16	382			
2979000	6.3	157	3180000	6.4	179	3420000	4.4	64	3638000	4.4	64	3938000	6.16	383			
2980000	6.3	157	3182000	6.4	193	3421000	4.6	69	3638100	4.4	64	3939000	6.16	383			
2981000	6.3	171	3184000	6.4	193	3423000	6.11	294	3662000	4.4	64	3940000	6.16	384			
2982000	6.3	163	3185000	6.4	193	3425000	4.4	64	3663000	4.4	64	3941000	6.16	384			
2983000	6.3	171	3191000	6.4	180	3431000	4.4	65	3675000	8.7	471	3942000	6.16	386			
2984000	6.3	171	3192000	6.4	180	3432000	4.4	64	3676000	8.7	471	3943000	6.16	385			
2985000	6.3	171	3235000	6.9	284	3433000	4.4	64	3681000	4.7	71	3944000	6.16	389			
2986099	6.3	171	3236000	6.9	284	3441000	4.7	70	3683000	4.6	68	3950000	6.16	374			
3001000	6.11	299	3237000	6.9	284	3442000	4.6	69	3750000	5.1	78	3951000	6.16	376			
3008000	4.8	72	3253000	6.9	287	3453000	4.5	68	3752000	6.2	151	3952000	6.16	372			
3009000	4.8	72	3254000	6.9	287	3455100	4.1	58	3753000	6.2	151	3953000	6.16	377			
3010000	4.4	65	3258000	6.9	285	3456000	4.1	58	3754000	6.2	151	3954000	6.16	376			
3016000	4.5	67	3259000	6.9	285	3457000	4.1	58	3756000	6.2	151	3955000	6.16	375			
3020000	4.1	59	3260000	6.9	285	3464000	6.2	131	3759000	6.2	151	3961000	6.16	379			
3021000	4.1	59	3261000	6.9	286	3465000	6.2	130	3761000	6.2	150	3962000	6.16	380			
3023000	4.1	59	3263000	6.9	285	3466000	6.2	129	3762000	6.2	150	3963000	6.9	282			
3030000	4.1	57	3264000	6.9	285	3467000	6.2	129	3764000	6.2	135	3964000	6.16	371			
3031000	4.1	57	3266000	6.9	286	3468000	6.2	129	3767000	6.2	133	3965000	6.16	371			
3032000	4.1	57	3267000	6.9	286	3470000	6.2	130	3768000	6.2	133	3967000	6.9	282			
3033000	4.1	57	3270000	6.9	286	3471000	6.2	130	3770000	6.2	133	3971000	6.9	282			
3034000	4.1	57	3271000	4.6	68	3472000	6.2	129	3772000	6.2	133	3975000	6.16	371			
3036000	4.11	75	3273000	4.6	69	3473000	6.2	129	3777000	6.2	145	3982000	6.16	388			
3037000	4.11	75	3274000	4.6	69	3474000	6.2	129	3800000	6.9	284	3983000	6.16	388			

Art. No.	PG	Page	Art. No.	PG	Page	Art. No.	PG	Page	Art. No.	PG	Page	Art. No.	PG	Page
3985000	6.16	379	4133000	7.1	392	4356000	8.4	447	4905000	6.15	355	5525000	3.1	46
3986000	6.16	372	4134000	7.1	393	4357000	8.4	449	4906000	6.15	356	5528000	3.1	50
3987000	6.16	372	4135000	7.1	393	4358000	8.4	448	4907000	6.15	357	5530000	3.1	49
3988000	6.16	369	4136000	7.1	397	4360000	8.4	455	4908000	6.15	359	5542000	3.3	52
3989000	6.16	369	4137000	7.1	397	4361000	8.4	455	4909000	6.15	356	5543000	3.3	53
3990000	6.16	369	4138000	7.1	398	4362000	8.4	455	4920000	6.11	295	5544000	3.3	55
3991000	6.16	377	4139000	7.1	398	4363000	8.4	451	5018000	6.14	352	5545000	3.3	55
3992000	6.16	379	4141000	7.1	398	4364000	8.4	454	5019000	6.14	352	5546000	3.3	54
3993000	6.16	379	4146000	7.1	398	4365000	8.4	451	5027000	6.11	293	5548000	3.3	51
3994000	6.16	376	4147000	7.1	399	4366000	8.4	451	5119000	8.3	443	5550000	8.6	465
3995000	6.16	375	4148000	7.1	400	4369000	8.4	453	5121000	8.3	442	5551000	8.6	469
3996000	6.16	378	4149000	7.1	400	4370000	6.7	267	5122000	8.3	444	5552000	8.6	468
3997000	6.16	375	4150000	7.1	394	4371000	6.7	267	5124000	8.3	445	5553000	8.6	466
3998000	6.16	377	4151000	7.1	401	4372000	6.7	267	5125000	8.3	444	5555000	8.6	464
3999000	6.16	374	4152000	7.1	401	4373000	6.7	267	5205000	7.2	416	5556000	8.6	469
4005000	8.2	440	4155000	7.1	394	4374000	6.7	267	5206000	7.2	416	5557000	8.6	469
4008000	8.2	430	4164000	7.1	409	4375000	6.7	267	5208000	7.2	414	5558000	8.6	467
4009000	8.2	430	4169000	7.1	407	4376000	6.7	270	5210000	7.2	413	5559000	8.6	468
4012000	8.2	437	4172000	7.1	404	4377000	6.7	270	5221000	7.2	414	5561000	8.6	467
4013000	8.2	431	4173000	7.1	404	4378000	6.7	270	5222000	7.2	415	5565000	8.6	466
4014000	8.2	429	4174000	7.1	405	4379000	6.7	270	5223000	7.2	415	5570000	8.4	454
4019000	8.2	429	4179000	7.1	407	4380000	6.7	271	5227000	7.2	414	5571000	8.4	454
4024000	8.2	432	4180000	7.1	407	4381000	6.7	271	5343000	6.12	325	5582000	3.3	54
4026000	8.2	431	4181000	7.1	407	4382000	6.7	265	5344000	6.12	325	5584000	3.3	53
4027000	8.2	428	4182000	7.1	407	4383000	6.7	265	5345000	6.12	325	5614000	6.4	209
4029000	8.2	428	4185000	7.1	404	4390000	6.7	266	5346000	6.12	325	5615000	6.4	209
4031000	8.2	433	4186000	7.1	404	4391000	6.7	264	5347000	6.12	325	5616000	6.4	209
4033000	8.2	432	4187000	7.1	404	4392000	6.7	269	5348000	6.12	325	5617000	6.4	183
4039000	8.2	431	4188000	7.1	405	4393000	6.7	273	5351000	6.12	326	5618000	6.4	205
4040000	8.2	434	4189000	7.1	405	4521000	6.11	297	5352000	6.12	326	5619000	6.4	201
4041000	8.2	432	4193000	7.1	410	4522000	6.11	296	5353000	6.12	326	5620000	6.4	201
4042000	8.2	433	4195000	7.1	401	4640000	5.1	77	5422000	6.2	134	5621000	6.4	203
4043000	8.2	436	4196000	7.1	408	4642000	5.4	84	5423000	6.2	135	5622000	6.4	191
4044000	8.2	436	4197000	7.1	408	4642100	5.4	84	5424000	6.2	131	5623000	6.4	192
4045000	8.2	433	4200000	7.1	391	4645000	5.1	81	5425000	6.2	127	5625000	6.4	194
4047000	8.2	435	4203000	7.1	408	4650000	5.1	77	5428000	6.2	127	5626000	6.4	195
4050000	8.2	439	4207000	7.1	406	4681000	6.11	298	5455000	6.2	136	5627000	6.4	189
4051000	8.2	435	4208000	7.1	406	4682000	6.11	298	5456000	6.2	136	5632000	6.4	183
4052000	8.2	437	4238000	6.16	381	4685000	6.11	297	5460000	6.2	126	5633000	6.4	183
4053000	8.2	434	4239000	6.16	382	4686000	6.11	298	5462000	6.2	135	5634000	6.4	183
4055000	8.2	434	4240000	6.16	384	4688000	6.3	174	5463000	6.2	135	5635000	6.4	183
4056000	8.2	438	4241000	6.16	385	4756000	6.4	214	5464000	6.2	135	5641000	6.4	234
4057000	8.2	438	4242000	6.16	385	4800000	6.11	301	5465000	6.2	135	5642000	6.4	234
4058000	8.2	438	4243000	6.16	384	4802000	6.11	301	5466000	6.2	135	5643000	6.4	234
4062000	8.2	435	4244000	6.16	386	4831000	6.15	360	5467000	6.2	135	5650000	6.4	206
4063000	8.2	435	4245000	6.16	387	4832000	6.15	360	5469000	6.2	135	5651000	6.4	206
4080000	7.1	403	4246000	6.16	388	4836000	6.15	361	5470000	6.2	135	5652000	6.4	206
4081000	7.1	395	4247000	6.16	389	4837000	6.15	361	5471000	6.2	135	5653000	6.4	206
4085000	7.1	403	4249000	6.16	389	4838000	6.15	361	5472000	6.2	135	5654000	6.4	206
4086000	7.1	403	4281000	7.1	411	4840000	6.15	362	5473000	6.2	136	5655000	6.4	206
4089000	7.1	394	4284000	7.1	395	4842000	6.15	362	5474000	6.2	136	5801000	6.4	190
4097000	7.1	399	4285000	7.1	396	4849000	6.15	362	5475000	6.2	136	5803000	6.4	190
4100000	7.1	410	4287000	7.1	411	4850000	6.15	363	5476000	6.2	136	5804000	6.4	190
4101000	7.1	410	4288000	7.1	402	4851000	6.15	363	5479000	6.2	136	5810000	6.4	223
4104000	7.1	402	4289000	7.1	402	4852000	6.15	363	5480000	6.2	126	5811000	6.4	223
4105000	6.4	233	4300000	7.1	411	4853000	6.15	366	5481000	6.2	126	5812000	6.4	223
4106000	7.1	393	4305000	7.1	397	4855000	6.15	366	5482000	6.2	127	5813000	6.4	223
4108000	7.1	409	4306000	7.1	396	4858000	6.15	366	5483000	6.2	126	5814000	6.4	224
4109000	7.1	409	4307000	7.1	404	4860000	8.1	424	5484000	6.2	135	5815000	6.4	224
4110000	6.1	124	4309000	7.1	405	4865000	6.15	364	5485000	6.2	136	5816000	6.4	224
4111000	6.1	124	4310000	7.1	407	4866000	6.15	364	5486000	6.2	136	5817000	6.4	224
4113000	6.1	124	4312000	7.1	406	4868000	6.15	363	5490000	6.2	126	5818000	6.4	224
4117000	7.1	409	4313000	7.1	404	4870000	6.15	364	5492000	6.2	136	5866000	6.4	218
4119000	7.1	399	4314000	7.1	405	4871000	6.15	367	5493000	6.2	136	5867000	6.4	218
4122000	7.1	400	4315000	6.7	268	4872000	6.15	365	5494000	6.2	136	5876000	6.4	218
4123000	7.1	401	4320000	7.1	391	4874000	6.15	365	5495000	6.2	136	5877000	6.4	218
4124000	7.1	403	4330000	8.4	453	4877000	6.15	367	5496000	6.2	136	5884000	6.4	219
4126000	7.1	408	4331000	8.4	452	4890000	6.15	367	5497000	6.2	136	5885000	6.4	219
4127000	7.1	406	4332000	8.4	452	4900000	6.15	357	5498000	6.2	136	5886000	6.4	219
4128000	7.1	406	4351000	8.4	450	4901000	6.15	355	5499000	6.2	152	5890000	6.4	217
4129000	7.1	407	4352000	8.4	450	4902000	6.15	358	5501000	3.1	47	5894000	6.4	217
4131000	7.1	392	4353000	8.4	449	4903000	6.15	358	5505000	3.1	48	5898000	6.4	223
4132000	7.1	392	4354000	8.4	448	4904000	6.15	359	5520000	3.1	45	5899000	6.4	223

Art. No.	PG	Page	Art. No.	PG	Page	Art. No.	PG	Page	Art. No.	PG	Page	Art. No.	PG	Page	Art. No.	PG	Page
5900000	6.4	223	6016000	6.4	227	6385000	6.6	255	6686000	6.6	258	6974000	8.5	461			
5911000	6.2	146	6017000	6.4	227	6456000	6.6	253	6730000	6.6	255	6985000	8.5	457			
5913000	6.2	149	6018000	6.4	227	6458000	6.6	253	6731000	6.6	255	6986000	8.5	458			
5915000	6.2	146	6043000	2.3	26	6463000	6.6	253	6732000	6.6	255	6987000	8.5	457			
5916000	6.2	146	6044000	2.3	26	6464000	6.6	253	6733000	6.6	255	6988000	8.5	462			
5917000	6.2	146	6045000	2.3	26	6466000	6.6	253	6734000	6.6	255	6999000	6.13	336			
5918000	6.2	146	6065000	2.3	33	6467000	6.6	253	6735000	6.6	255	7000000	6.13	337			
5920000	6.2	148	6066000	2.3	28	6468000	6.6	253	6736000	6.6	255	7010000	6.13	338			
5922000	6.2	148	6067000	2.3	28	6472000	6.6	253	6737000	6.6	255	7011000	6.13	338			
5924000	6.2	148	6068000	2.3	28	6473000	6.6	253	6738000	6.6	255	7012000	6.13	338			
5926000	6.2	148	6071000	2.3	29	6475000	6.6	253	6739000	6.6	255	7015000	6.13	338			
5928000	6.2	148	6072000	2.3	29	6476000	6.6	253	6740000	6.6	259	7016000	6.13	338			
5929000	6.2	148	6073000	2.3	39	6477000	6.6	253	6741000	6.6	259	7017000	6.13	338			
5930000	6.2	148	6074000	2.3	32	6481000	6.6	253	6742000	6.6	259	7021000	6.13	339			
5931000	6.2	148	6075000	2.3	32	6501000	6.6	262	6779000	2.3	28	7025000	6.13	339			
5932000	6.2	148	6077000	2.3	32	6502000	6.6	262	6780000	2.3	29	7026000	6.13	339			
5933000	6.2	148	6085000	2.3	40	6511000	6.6	262	6781000	2.3	29	7028000	6.13	339			
5940000	6.2	148	6086000	2.3	40	6517000	6.6	262	6782000	2.3	27	7028100	6.13	339			
5941000	6.2	149	6091000	2.3	42	6521000	6.6	261	6783000	2.3	31	7030000	6.13	339			
5942000	6.2	149	6092000	2.3	42	6522000	6.6	261	6784000	2.3	31	7031000	6.13	339			
5943000	6.2	149	6093000	2.3	42	6527000	6.6	261	6785000	2.3	27	7032000	6.13	339			
5944000	6.2	149	6094000	2.3	42	6540000	6.6	260	6786000	2.3	27	7032100	6.13	339			
5945000	6.2	149	6095000	6.4	227	6541000	6.6	260	6787000	2.3	27	7036000	6.13	339			
5946000	6.2	149	6096000	6.4	227	6542000	6.6	260	6788000	2.3	32	7037000	6.13	339			
5947000	6.2	149	6097000	6.4	227	6543000	6.6	260	6790000	2.3	30	7037100	6.13	339			
5948000	6.2	149	6098000	6.4	227	6544000	6.6	260	6791000	2.3	30	7042000	6.13	339			
5949000	6.2	149	6099000	2.3	42	6545000	6.6	261	6792000	2.3	31	7042100	6.13	339			
5955000	6.2	128	6102300	1.1	7	6546000	6.6	261	6800000	2.3	41	7045000	6.13	340			
5956000	6.2	128	6119973	1.1	7	6547000	6.6	261	6801000	2.3	41	7046000	6.13	339			
5957000	6.2	134	6152000	1.96	14	6548000	6.6	261	6802000	2.3	41	7047000	6.13	339			
5958000	6.2	134	6171000	2.1	21	6549000	6.6	261	6803000	2.3	42	7049000	6.13	339			
5959000	6.2	145	6172000	2.1	21	6550000	6.6	262	6804000	2.3	41	7056000	6.13	337			
5960000	6.2	145	6174000	2.1	21	6551000	6.6	262	6806000	2.3	43	7057000	6.13	337			
5961000	6.2	145	6176000	2.1	22	6552000	6.6	262	6901000	1.96	15	7076000	6.13	337			
5962000	6.2	145	6177000	2.1	20	6553000	6.6	262	6902000	1.4	8	7078000	6.13	336			
5963000	6.2	136	6182000	2.1	19	6554000	6.6	262	6902506	1.4	8	7079000	6.13	336			
5964000	6.2	137	6197000	1.4	12	6567000	6.6	252	6902612	1.4	8	7080000	6.13	334			
5965000	6.2	137	6255000	6.6	256	6568000	6.6	252	6903000	1.96	15	7081000	6.13	334			
5966000	6.2	137	6256000	6.6	256	6577000	6.6	252	6904000	1.96	15	7088000	6.13	335			
5967000	6.2	137	6258000	6.6	256	6581000	6.6	252	6905000	1.1	6	7089000	6.13	335			
5968000	6.2	137	6259000	6.6	256	6583000	6.6	258	6906000	1.4	10	7100000	6.12	305			
5969000	6.2	137	6263000	6.6	256	6584000	6.6	258	6906506	1.4	10	7101000	6.12	305			
5970000	6.2	137	6264000	6.6	256	6593000	6.6	259	6906612	1.4	10	7102000	6.12	305			
5971000	6.2	137	6267000	6.6	256	6594000	6.6	259	6908000	2.1	18	7103000	6.12	307			
5972000	6.2	137	6268000	6.6	256	6595000	6.6	259	6910000	1.6	13	7104000	6.12	307			
5973000	6.2	137	6272000	6.6	256	6600000	6.6	260	6911000	1.6	14	7105000	6.12	307			
5974000	6.2	137	6273000	6.6	256	6602000	6.6	260	6913000	1.6	12	7106000	6.12	307			
5977000	6.2	137	6275000	6.6	256	6604000	6.6	260	6914000	1.6	13	7107000	6.12	309			
5978000	6.2	138	6276000	6.6	256	6606000	6.6	260	6916000	1.96	16	7108000	6.12	309			
5979000	6.2	140	6277000	6.6	256	6608000	6.6	260	6917000	1.96	16	7109000	6.12	318			
5980000	6.2	135	6281000	6.6	256	6620000	6.6	252	6921000	8.1	426	7110000	6.12	318			
5981000	6.2	150	6340000	6.6	257	6621000	6.6	252	6925000	8.1	420	7111000	6.12	319			
5982000	6.2	127	6341000	6.6	257	6622000	6.6	252	6927000	8.1	422	7112000	6.12	319			
5983000	6.2	138	6342000	6.6	257	6623000	6.6	252	6928000	8.1	422	7113000	6.12	325			
5984000	6.2	138	6343000	6.6	257	6624000	6.6	252	6929000	8.1	423	7114000	6.12	327			
5985000	6.2	139	6344000	6.6	257	6625000	6.6	252	6931000	8.1	424	7115000	6.12	330			
5986000	6.2	139	6355000	6.6	254	6630000	6.6	254	6933000	8.1	419	7116000	6.12	330			
5990000	6.12	329	6356000	6.6	254	6631000	6.6	254	6937000	8.1	419	7117000	6.12	330			
5991000	6.12	329	6358000	6.6	254	6632000	6.6	254	6939000	8.1	418	7118000	6.12	303			
5992000	6.12	329	6359000	6.6	254	6633000	6.6	254	6945000	8.1	421	7119000	6.12	317			
5993000	6.12	329	6363000	6.6	254	6634000	6.6	254	6946000	8.1	424	7120000	6.12	308			
5994000	6.12	329	6364000	6.6	254	6635000	6.6	254	6947000	8.1	423	7121000	6.12	306			
5995000	6.2	149	6365000	6.6	254	6644000	6.6	255	6948000	8.1	425	7122000	6.12	310			
5996000	6.2	149	6366000	6.6	254	6646000	6.6	255	6948200	8.1	425	7123000	6.12	320			
5997000	6.2	149	6367000	6.6	254	6650000	6.6	255	6949000	8.1	426	7124000	6.12	305			
5998000	6.2	149	6368000	6.6	254	6660000	6.6	259	6950000	8.1	420	7125000	6.12	305			
5999000	6.2	149	6372000	6.6	254	6662000	6.6	259	6951000	8.1	421	7126000	6.12	305			
6010000	6.4	227	6373000	6.6	254	6664000	6.6	259	6952000	8.1	425	7127000	6.12	305			
6011000	6.4	227	6375000	6.6	254	6666000	6.6	259	6960000	8.5	459	7128000	6.12	305			
6012000	6.4	227	6376000	6.6	254	6668000	6.6	259	6961000	8.5	458	7129000	6.12	305			
6013000	6.4	227	6377000	6.6	254	6680000	6.6	258	6971000	8.5	460	7130000	6.12	305			
6014000	6.4	227	6379000	6.6	254	6682000	6.6	258	6972000	8.5	461	7131000	6.12	312			
6015000	6.4	227	6381000	6.6	254	6684000	6.6	258	6973000	8.5	461	7132000	6.12	312			

Art. No.	PG	Page
8329000	6.14	347
8330000	6.14	348
8331000	6.14	348
8334000	6.14	348
8335000	6.14	348
8336000	6.14	348
8369000	6.14	351
8370000	6.14	351
8372000	6.14	346
8373000	6.14	346
8375000	6.14	346
8381000	6.14	349
8382000	6.14	350
8383000	6.14	349
8385000	6.14	349
8386000	6.14	349
8387000	6.14	350
8389000	6.14	349
8390000	6.14	351
8392000	6.14	350
8401000	6.4	179
8403000	6.4	198
8404000	6.4	182
8406600	6.4	197
8409000	6.4	192
8410000	6.4	194
8411000	6.4	195
8415000	6.4	187
8417000	6.4	186
8421099	6.4	208
8422099	6.4	207
8423099	6.4	208
8424099	6.4	207
8425000	6.4	207
8426000	6.4	207
8430000	6.1	102
8431000	6.1	94
8432000	6.1	95
8433000	6.1	95
8434000	6.1	96
8437000	6.1	122
8440000	6.1	113
8441000	6.1	108
8442000	6.1	108
8443000	6.1	108
8444000	6.1	110
8450000	6.12	319
8453000	6.12	307
8456000	6.12	325
8458000	6.12	309
8460000	6.14	343
8461000	6.14	343
8464000	6.4	181
8465000	6.4	204
8467000	6.4	197
8468000	6.4	196
8469000	6.4	200
8470000	6.5	236
8471000	6.5	236
8472000	6.5	236
8473000	6.5	237
8474000	6.5	237
8475000	6.5	239
8476000	6.5	246
8477000	6.5	240
8478000	6.5	241
8479000	6.5	246
8490000	6.16	380
8491000	6.16	380
8611000	6.12	330
8613000	6.12	325
8614000	6.12	307
8615000	6.12	330

Art. No.	PG	Page
8616000	6.12	318
8630000	6.1	102
8631000	6.1	113
8632000	6.12	307
8633000	6.3	157
8634000	6.12	319
8635000	6.12	309
8722000	8.2	439
8725000	6.3	167
8728000	6.12	315
8732500	8.3	445
8753000	6.9	283
8754000	6.9	283
8771000	6.2	147
8788000	6.4	221
8789000	6.4	222
8790000	6.4	222
8797000	6.3	175
8911000	6.2	147
8912000	6.2	143
8913000	6.2	131
8914000	6.2	126
8916000	6.2	144
8917000	6.2	143
8918000	6.2	143
8925000	6.2	151
9999997	2.3	24

Legend

TIN	= Titanium nitride, compound of evaporated titanium and nitrogen
HSS-Co	= High-speed steel with a high cobalt percentage (more than 5 %)
HSS	= High Speed Steel
HM	= Tungsten carbide tipped
WS	= Tool steel
CV	= Chromium Vanadium
BiM	= BiMetal, flexible and hard
HCS	= High Carbon Steel
HAS	= High Alloy Steel

 = 10 year guarantee

We provide a warranty of 10 years from the day of purchase on the wolcraft product you acquired, provided it is exclusively used for DIY purposes.
The warranty only covers damage to the item purchased, and only such damage that can be attributed to faulty material and poor workmanship.
The warranty does not cover defects and damage that must be attributed to improper use or insufficient maintenance. Nor does the warranty cover the usual wear and tear as well as defects and damage, of which the customer has been aware when purchasing the equipment.

Warranty claims can only be asserted by producing the invoice or the till receipt.

The warranty granted by wolcraft does not in any way restrict your statutory consumer rights (i.e. contract performance, withdrawal from the contract, price reduction, claims for damages or reimbursement of expenses).

Individual articles may be subject to technical changes.

Dimensions, colours as well as product images and descriptions may deviate from the original.
The content of the catalogue is subject to the above conditions.

ILN 4006885000001

VAT Number DE 147924531

wolcraft®

Main catalogue



Innovative Tools Universal accessories



wolcraft GmbH
Wolffstraße 1
D-56746 Kempenich

Service Hotline: 00 49 (0) 2655 51 280
Fax: 00 49 (0) 26 55 50 21 80
E-mail: customerservice@wolcraft.com

Technischer Support
Fax: 00 49 (0) 2655 50 20 80
E-mail: technical.Service@wolcraft.com

www.wolcraft.com



GB 9999376 / 1300 / 01.19



Main catalogue

Innovative Tools Universal accessories

Effective January 2nd 2019

X-ON Electronics

Largest Supplier of Electrical and Electronic Components

Click to view similar products for [Hand Tools](#) category:

Click to view products by [Wolcraft](#) manufacturer:

Other Similar products are found below :

[58284-1](#) [662908-1](#) [68764-0001](#) [690619-6](#) [D20419-189](#) [7-354778-7](#) [768531-1](#) [821903-5](#) [822253-1](#) [854183-1](#) [854358-1](#) [992258-1](#) [1-21046-3](#)
[1-22278-0](#) [1-22278-2](#) [1-24954-2](#) [125529-5](#) [126513-1](#) [1-305579-8](#) [1320846-1](#) [1338618-1](#) [1338968-2](#) [1-354779-0](#) [1-354779-2](#) [1-354779-4](#)
[1424443-1](#) [1424289-1](#) [1424444-1](#) [MS24256A16](#) [1-525442-0](#) [1532195-2](#) [1538773-2](#) [1-59681-8](#) [1-59907-5](#) [1-692134-3](#) [1725760-1](#) [HT-](#)
[920A-124-HTELE-RPL-KIT](#) [1976923-1](#) [1976969-1](#) [2063794-1](#) [2063795-1](#) [2-21002-1](#) [2-21002-3](#) [2-21002-4](#) [2-21002-7](#) [2-21002-9](#) [2-21004-](#)
[0](#) [229399-2](#) [229707-1](#) [911737-2](#)