

C3M0032120K

Silicon Carbide Power MOSFET

C3M™ MOSFET Technology

N-Channel Enhancement Mode

Features

- 3rd generation SiC MOSFET technology
- Optimized package with separate driver source pin
- 8mm of creepage distance between drain and source
- High blocking voltage with low on-resistance
- High-speed switching with low capacitances
- Fast intrinsic diode with low reverse recovery (Q_{rr})
- Halogen free, RoHS compliant

Benefits

- Reduce switching losses and minimize gate ringing
- Higher system efficiency
- Reduce cooling requirements
- Increase power density
- Increase system switching frequency

Applications

- Solar inverters
- EV motor drive
- High voltage DC/DC converters
- Switched mode power supplies
- Load switch

V_{DS}	1200 V
$I_D @ 25^\circ\text{C}$	63 A
$R_{DS(on)}$	32 mΩ

Package

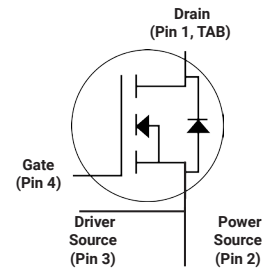

Part Number	Package	Marking
C3M0032120K	TO 247-4	C3M0032120K

Maximum Ratings ($T_c = 25^\circ\text{C}$ unless otherwise specified)

Symbol	Parameter	Value	Unit	Test Conditions	Note
V_{DSmax}	Drain - Source Voltage	1200	V	$V_{GS} = 0\text{ V}, I_D = 100\ \mu\text{A}$	
V_{GSmax}	Gate - Source Voltage (dynamic)	-8/+19	V	AC ($f > 1\text{ Hz}$)	Note 1
V_{GSop}	Gate - Source Voltage (static)	-4/+15	V	Static	Note 2
I_D	Continuous Drain Current	63	A	$V_{GS} = 15\text{ V}, T_c = 25^\circ\text{C}$	Fig. 19
		48		$V_{GS} = 15\text{ V}, T_c = 100^\circ\text{C}$	
$I_{D(pulse)}$	Pulsed Drain Current	120	A	Pulse width t_p limited by T_{jmax}	
P_D	Power Dissipation	283	W	$T_c = 25^\circ\text{C}, T_j = 175^\circ\text{C}$	Fig. 20
T_J, T_{stg}	Operating Junction and Storage Temperature	-40 to +175	$^\circ\text{C}$		
T_L	Solder Temperature	260	$^\circ\text{C}$	1.6mm (0.063") from case for 10s	

Note (1): When using MOSFET Body Diode $V_{GSmax} = -4\text{V}/+19\text{V}$

Note (2): MOSFET can also safely operate at 0/+15 V

Electrical Characteristics ($T_c = 25^\circ\text{C}$ unless otherwise specified)

Symbol	Parameter	Min.	Typ.	Max.	Unit	Test Conditions	Note
$V_{(BR)DSS}$	Drain-Source Breakdown Voltage	1200			V	$V_{GS} = 0\text{ V}, I_D = 100\ \mu\text{A}$	
$V_{GS(th)}$	Gate Threshold Voltage	1.8	2.5	3.6	V	$V_{DS} = V_{GS}, I_D = 11.5\ \text{mA}$	Fig. 11
			2.0		V	$V_{DS} = V_{GS}, I_D = 11.5\ \text{mA}, T_J = 175^\circ\text{C}$	
I_{DSS}	Zero Gate Voltage Drain Current		1	50	μA	$V_{DS} = 1200\ \text{V}, V_{GS} = 0\ \text{V}$	
I_{GSS}	Gate-Source Leakage Current		10	250	nA	$V_{GS} = 15\ \text{V}, V_{DS} = 0\ \text{V}$	
$R_{DS(on)}$	Drain-Source On-State Resistance	23	32	43	m Ω	$V_{GS} = 15\ \text{V}, I_D = 40\ \text{A}$	Fig. 4, 5, 6
			57.6			$V_{GS} = 15\ \text{V}, I_D = 40\ \text{A}, T_J = 175^\circ\text{C}$	
g_{fs}	Transconductance		27		S	$V_{DS} = 20\ \text{V}, I_{DS} = 40\ \text{A}$	Fig. 7
			22			$V_{DS} = 20\ \text{V}, I_{DS} = 40\ \text{A}, T_J = 175^\circ\text{C}$	
C_{iss}	Input Capacitance		3357		pF	$V_{GS} = 0\ \text{V}, V_{DS} = 1000\ \text{V}$ $f = 100\ \text{kHz}$ $V_{AC} = 25\ \text{mV}$	Fig. 17, 18
C_{oss}	Output Capacitance		129				
C_{riss}	Reverse Transfer Capacitance		8				
E_{oss}	C_{oss} Stored Energy		76		μJ		Fig. 16
E_{ON}	Turn-On Switching Energy (SiC Diode FWD)		367		μJ	$V_{DS} = 800\ \text{V}, V_{GS} = -4\ \text{V}/+15\ \text{V}, I_D = 40\ \text{A},$ $R_{G(ext)} = 2.5\ \Omega, L = 65.7\ \mu\text{H}, T_J = 175^\circ\text{C}$	Fig. 26
E_{OFF}	Turn Off Switching Energy (SiC Diode FWD)		123				
E_{ON}	Turn-On Switching Energy (Body Diode FWD)		955		μJ	$V_{DS} = 800\ \text{V}, V_{GS} = -4\ \text{V}/+15\ \text{V}, I_D = 40\ \text{A},$ $R_{G(ext)} = 2.5\ \Omega, L = 65.7\ \mu\text{H}, T_J = 175^\circ\text{C}$	Fig. 26
E_{OFF}	Turn Off Switching Energy (Body Diode FWD)		107				
$t_{d(on)}$	Turn-On Delay Time		25		ns	$V_{DD} = 800\ \text{V}, V_{GS} = -4\ \text{V}/15\ \text{V}$ $R_{G(ext)} = 2.5\ \Omega, I_D = 40\ \text{A}, L = 65.7$ Timing relative to V_{DS} , Inductive load	Fig. 27
t_r	Rise Time		18				
$t_{d(off)}$	Turn-Off Delay Time		32				
t_f	Fall Time		9				
$R_{G(int)}$	Internal Gate Resistance		1.7		Ω	$f = 1\ \text{MHz}, V_{AC} = 25\ \text{mV}$	
Q_{gs}	Gate to Source Charge		40		nC	$V_{DS} = 800\ \text{V}, V_{GS} = -4\ \text{V}/15\ \text{V}$ $I_D = 40\ \text{A}$ Per IEC60747-8-4 pg 21	Fig. 12
Q_{gd}	Gate to Drain Charge		34				
Q_g	Total Gate Charge		118				

Reverse Diode Characteristics ($T_c = 25^\circ\text{C}$ unless otherwise specified)

Symbol	Parameter	Typ.	Max.	Unit	Test Conditions	Note
V_{SD}	Diode Forward Voltage	4.6		V	$V_{GS} = -4\text{ V}, I_{SD} = 20\text{ A}, T_J = 25^\circ\text{C}$	Fig. 8, 9, 10
		4.2		V	$V_{GS} = -4\text{ V}, I_{SD} = 20\text{ A}, T_J = 175^\circ\text{C}$	
I_S	Continuous Diode Forward Current		62	A	$V_{GS} = -4\text{ V}, T_c = 25^\circ\text{C}$	Note 1
$I_{S, pulse}$	Diode pulse Current		120	A	$V_{GS} = -4\text{ V}$, pulse width t_p limited by T_{jmax}	Note 1
t_{rr}	Reverse Recover time	27		ns	$V_{GS} = -4\text{ V}, I_{SD} = 40\text{ A}, V_R = 800\text{ V}$ $di/dt = 2250\text{ A}/\mu\text{s}, T_J = 175^\circ\text{C}$	Note 1
Q_{rr}	Reverse Recovery Charge	478		nC		
I_{rrm}	Peak Reverse Recovery Current	27		A		

Thermal Characteristics

Symbol	Parameter	Typ.	Unit	Test Conditions	Note
$R_{\theta JC}$	Thermal Resistance from Junction to Case	0.45	$^\circ\text{C}/\text{W}$		Fig. 21
$R_{\theta JA}$	Thermal Resistance From Junction to Ambient	40			

Typical Performance

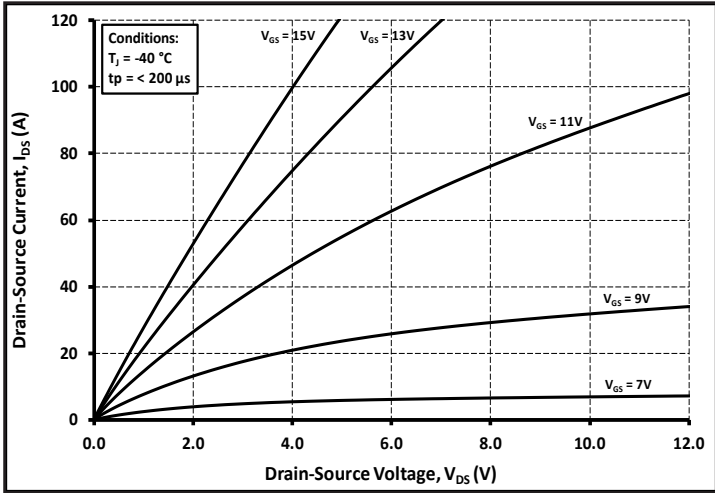

Figure 1. Output Characteristics $T_J = -40\text{ }^\circ\text{C}$

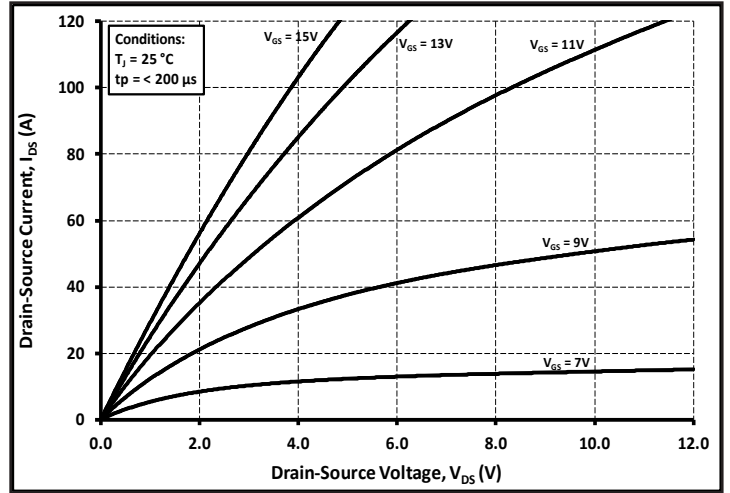

Figure 2. Output Characteristics $T_J = 25\text{ }^\circ\text{C}$

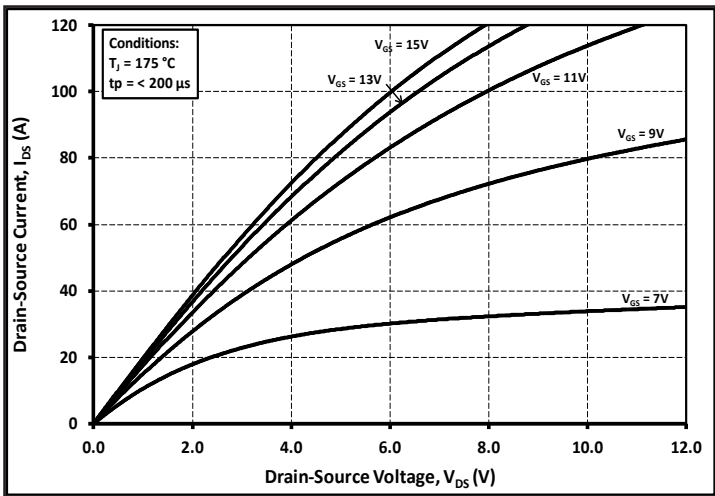

Figure 3. Output Characteristics $T_J = 175\text{ }^\circ\text{C}$

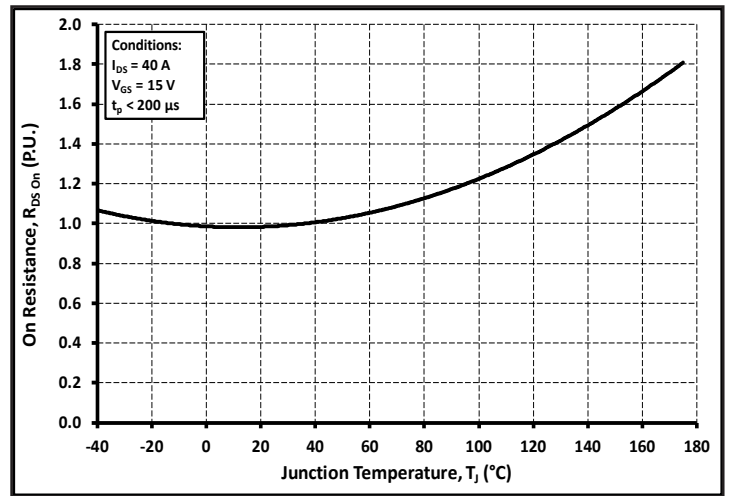

Figure 4. Normalized On-Resistance vs. Temperature

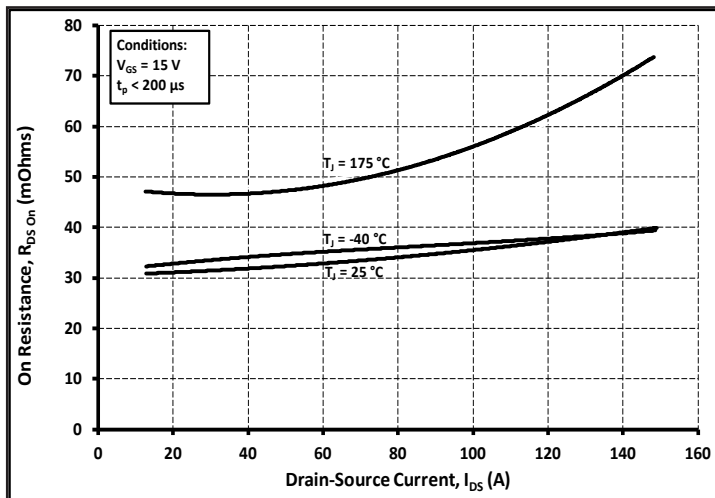

Figure 5. On-Resistance vs. Drain Current For Various Temperatures

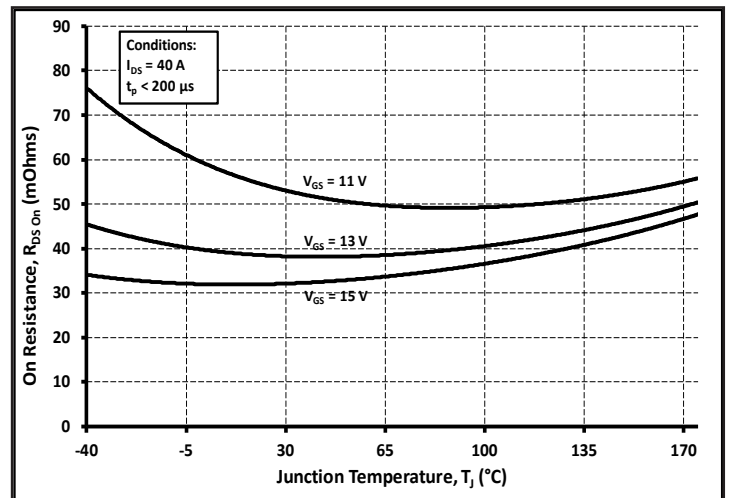

Figure 6. On-Resistance vs. Temperature For Various Gate Voltage

Typical Performance

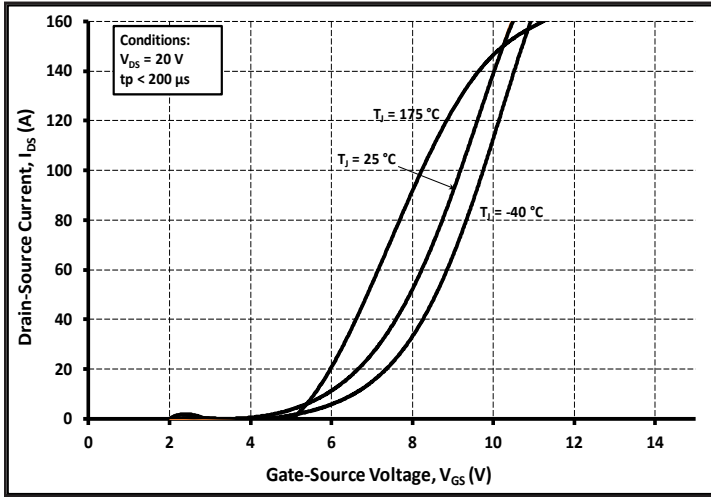

Figure 7. Transfer Characteristic for Various Junction Temperatures

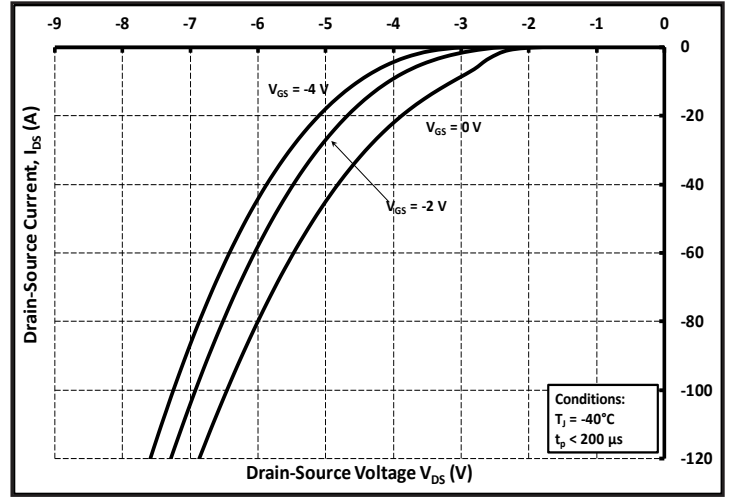

Figure 8. Body Diode Characteristic at -40 °C

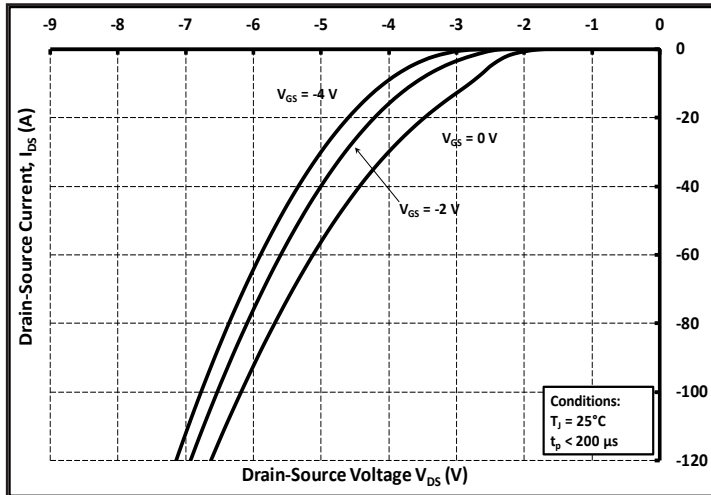

Figure 9. Body Diode Characteristic at 25 °C

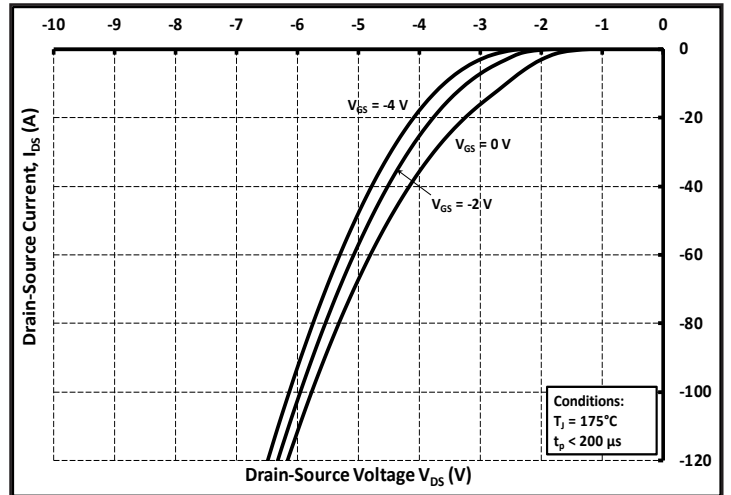

Figure 10. Body Diode Characteristic at 175 °C

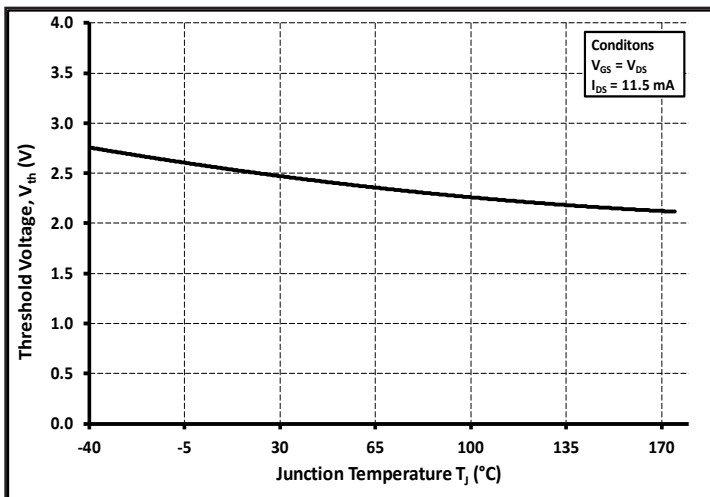

Figure 11. Threshold Voltage vs. Temperature

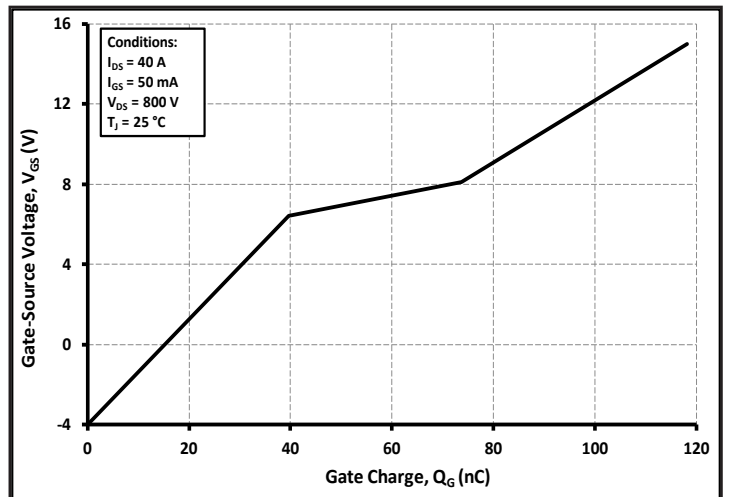

Figure 12. Gate Charge Characteristics

Typical Performance

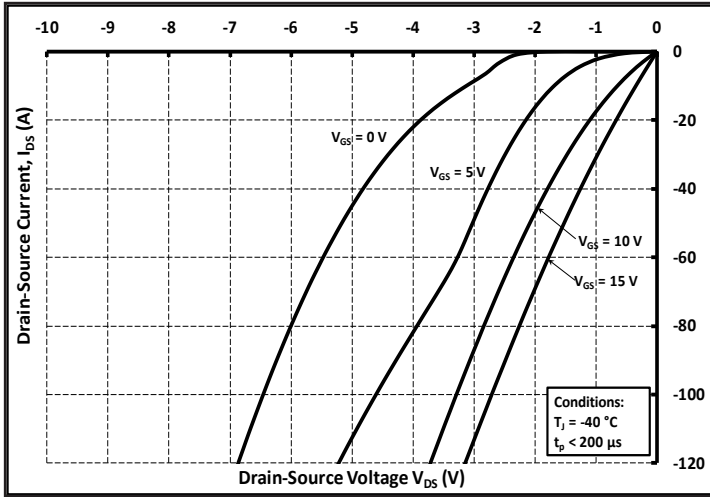

Figure 13. 3rd Quadrant Characteristic at -40 °C

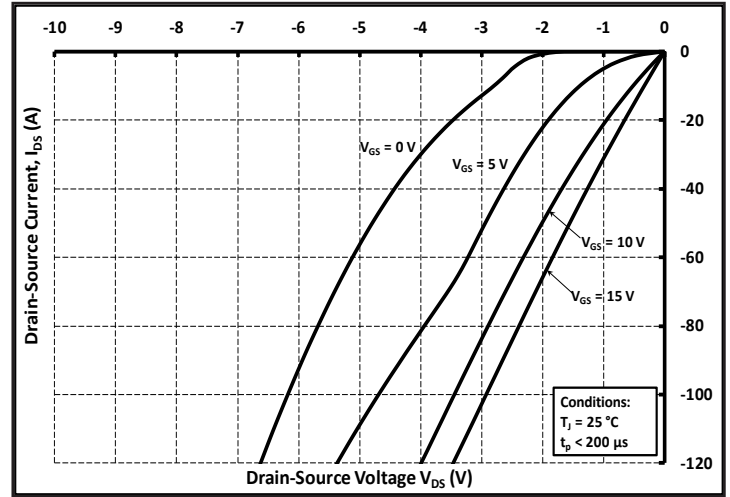

Figure 14. 3rd Quadrant Characteristic at 25 °C

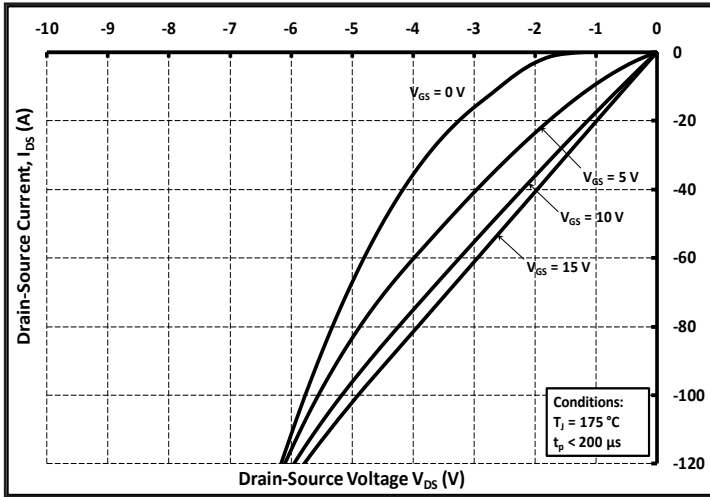

Figure 15. 3rd Quadrant Characteristic at 175 °C

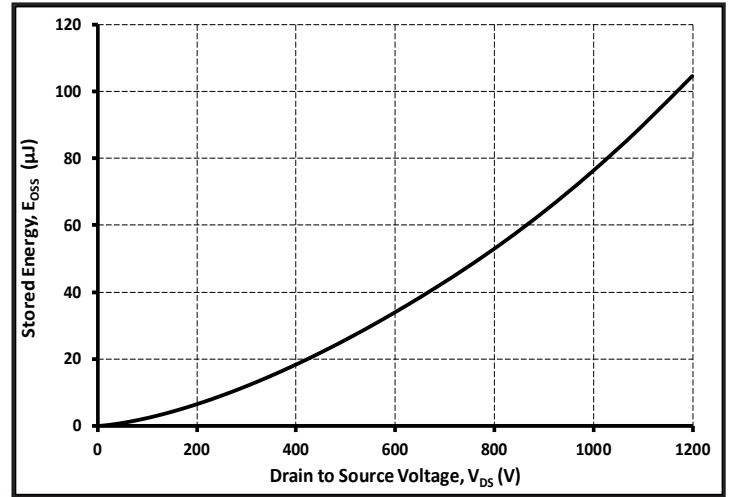

Figure 16. Output Capacitor Stored Energy

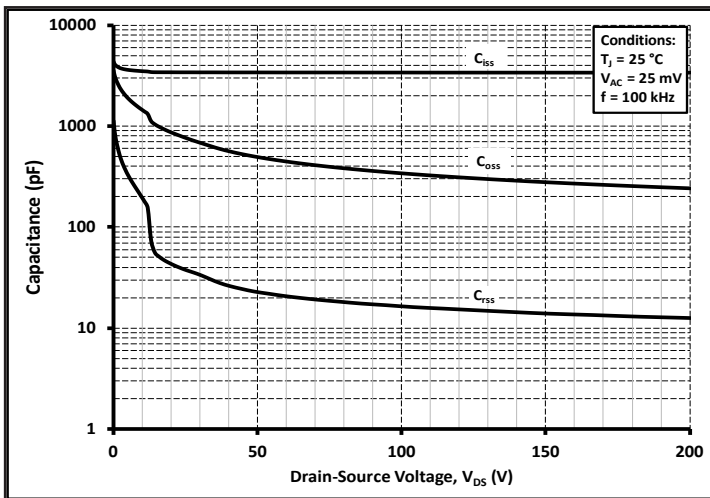

Figure 17. Capacitances vs. Drain-Source Voltage (0 - 200V)

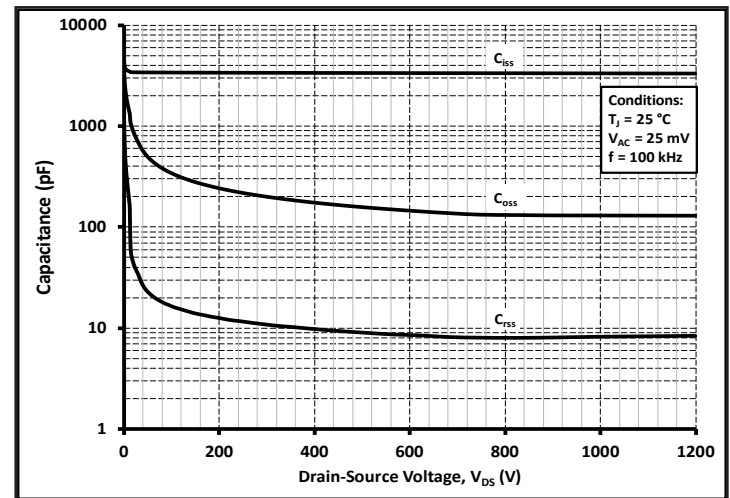

Figure 18. Capacitances vs. Drain-Source Voltage (0 - 1200V)

Typical Performance

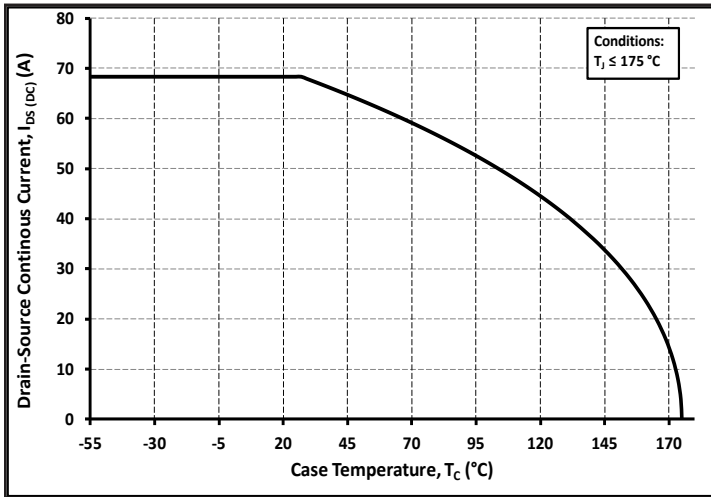

Figure 19. Continuous Drain Current Derating vs. Case Temperature

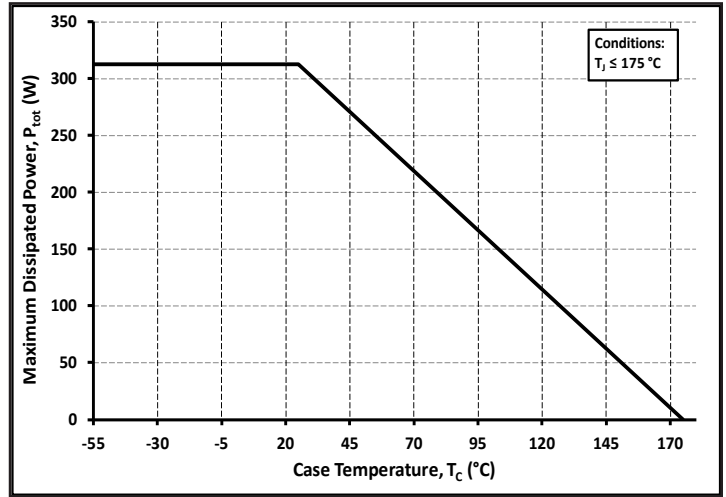

Figure 20. Maximum Power Dissipation Derating vs. Case Temperature

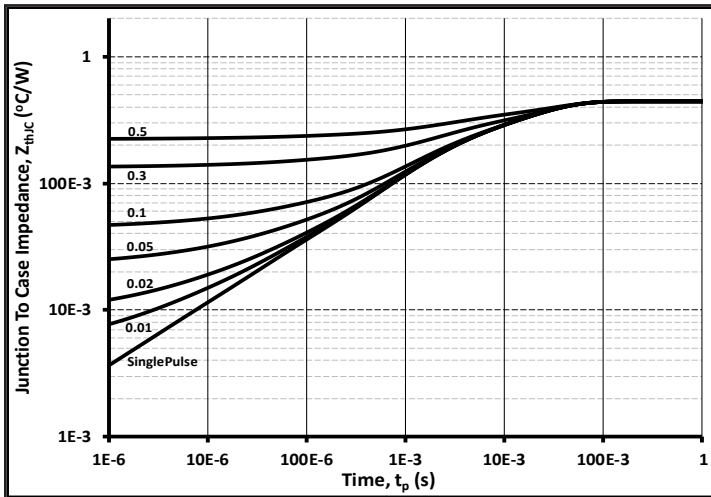

Figure 21. Transient Thermal Impedance (Junction - Case)

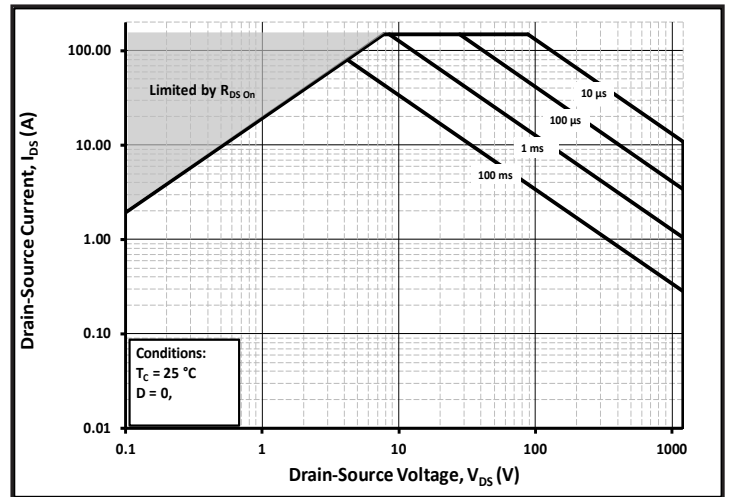

Figure 22. Safe Operating Area

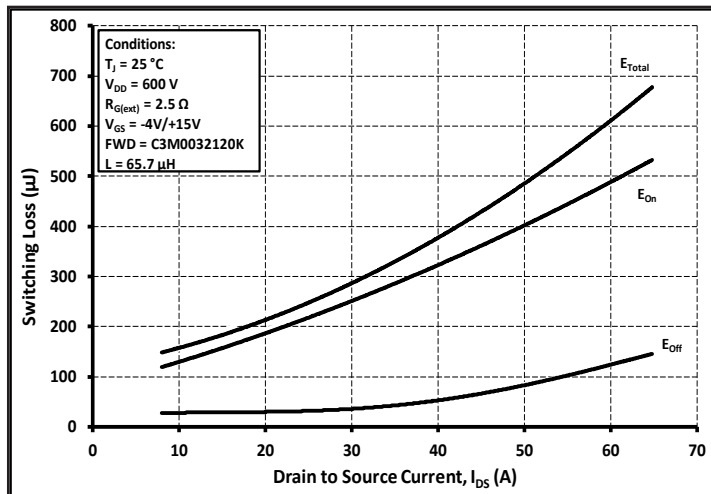

Figure 23. Clamped Inductive Switching Energy vs. Drain Current ($V_{DD} = 600V$)

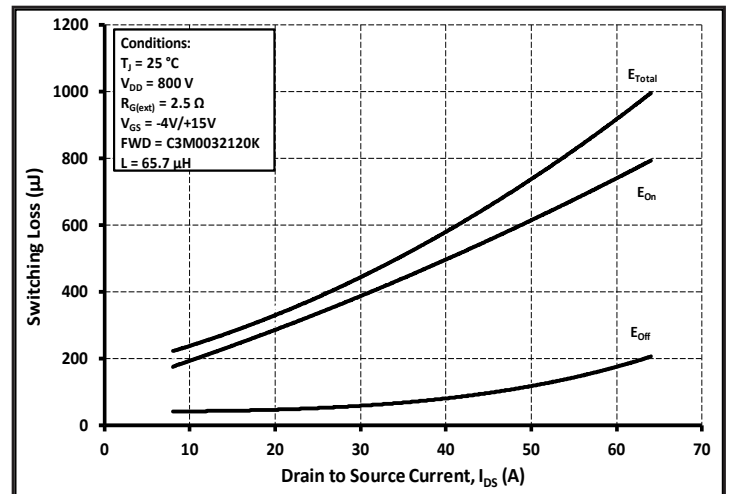

Figure 24. Clamped Inductive Switching Energy vs. Drain Current ($V_{DD} = 800V$)

Typical Performance

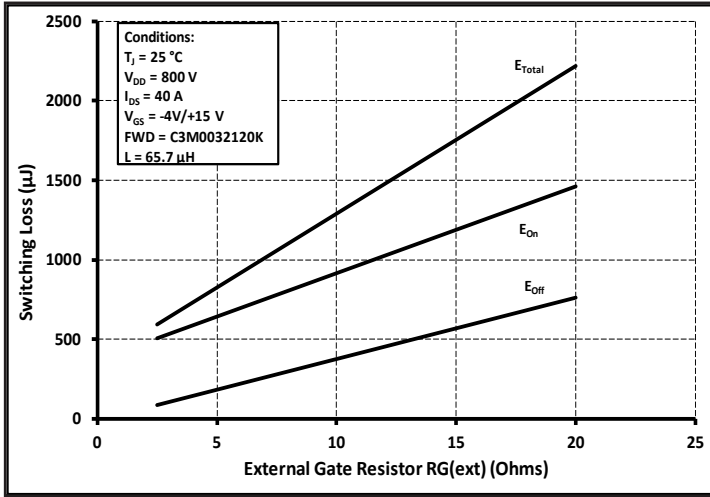

Figure 25. Clamped Inductive Switching Energy vs. $R_{G(\text{ext})}$

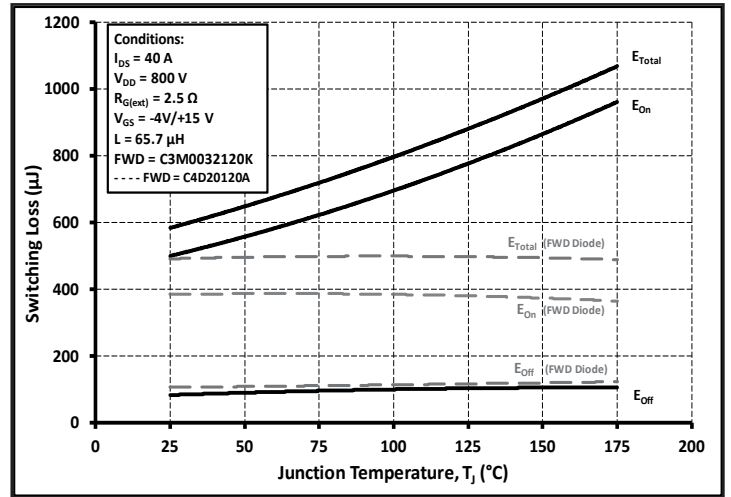

Figure 26. Clamped Inductive Switching Energy vs. Temperature

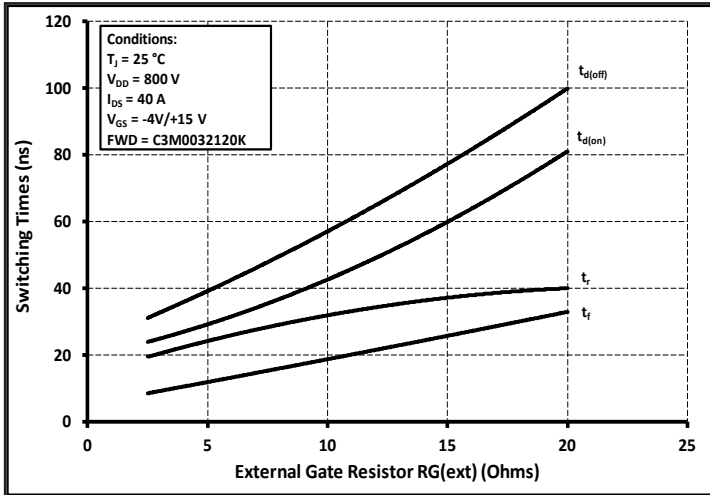

Figure 27. Switching Times vs. $R_{G(\text{ext})}$

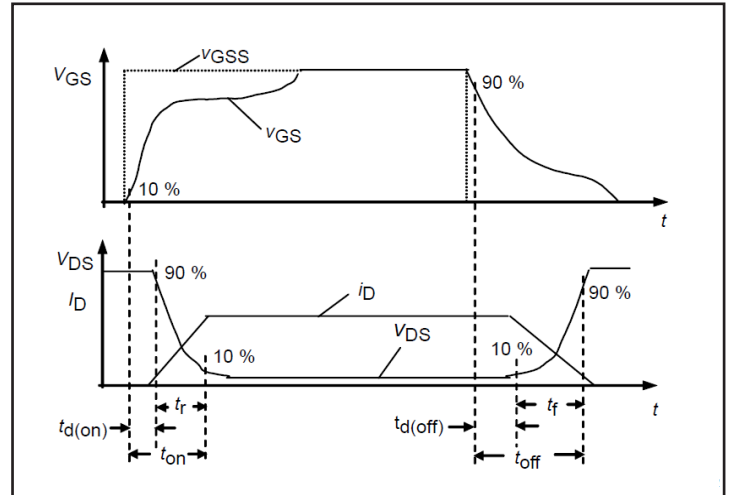

Figure 28. Switching Times Definition

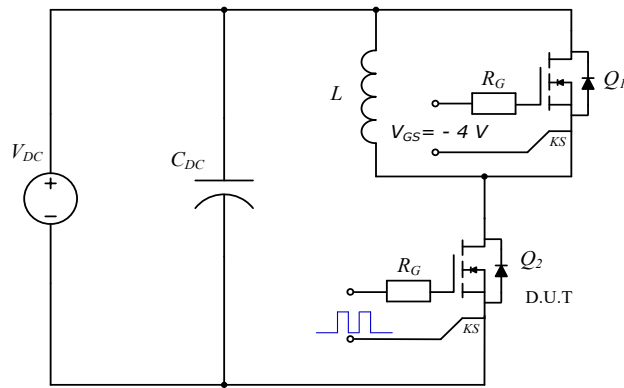
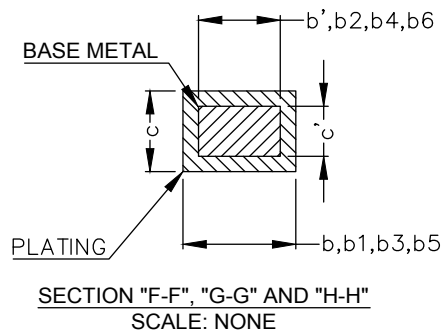
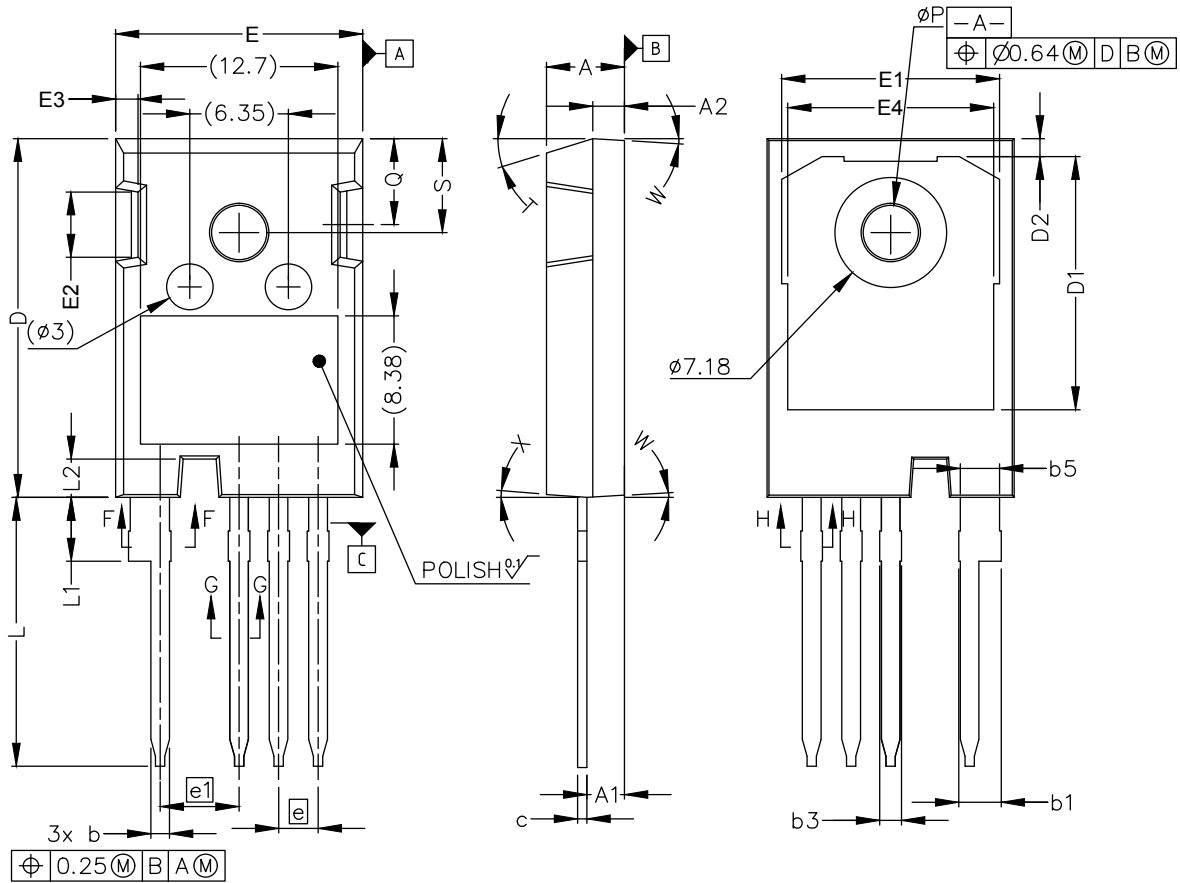

Figure 29. Clamped Inductive Switching
Waveform Test Circuit

Note (3): Turn-off and Turn-on switching energy and timing values measured using SiC MOSFET Body Diode as shown above.

Package Dimensions

Package TO-247-4L



Package Dimensions

Package TO-247-4L

NOTE ;

1. ALL METAL SURFACES: TIN PLATED, EXCEPT AREA OF CUT
2. DIMENSIONING & TOLERANCING CONFIRM TO ASME Y14.5M-1994.
3. ALL DIMENSIONS ARE IN MILLIMETERS. ANGLES ARE IN DEGREES.

SYM	MILLIMETERS		SYM	MILLIMETERS	
	MIN	MAX		MIN	MAX
A	4.83	5.21	E1	13.10	14.15
A1	2.29	2.54	E2	3.68	5.10
A2	1.91	2.16	E3	1.00	1.90
b'	1.07	1.28	E4	12.38	13.43
b	1.07	1.33	e	2.54 BSC	
b1	2.39	2.94	e1	5.08 BSC	
b2	2.39	2.84	N	4	
b3	1.07	1.60	L	17.31	17.82
b4	1.07	1.50	L1	3.97	4.37
b5	2.39	2.69	L2	2.35	2.65
b6	2.39	2.64	∅P	3.51	3.65
c'	0.55	0.65	Q	5.49	6.00
c	0.55	0.68	S	6.04	6.30
D	23.30	23.60	T	17.5° REF.	
D1	16.25	17.65	W	3.5° REF.	
D2	0.95	1.25	X	4° REF.	
E	15.75	16.13			

Recommended Solder Pad Layout

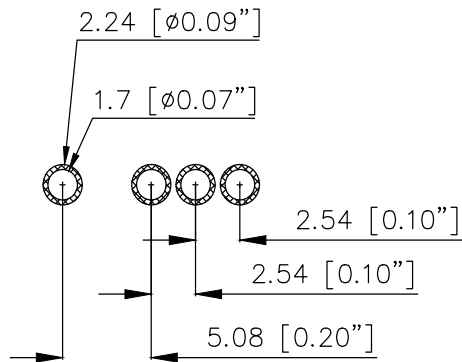

Notes

- **RoHS Compliance**
The levels of RoHS restricted materials in this product are below the maximum concentration values (also referred to as the threshold limits) permitted for such substances, or are used in an exempted application, in accordance with EU Directive 2011/65/EC (RoHS2), as implemented January 2, 2013. RoHS Declarations for this product can be obtained from your Cree representative or from the Product Documentation sections of www.cree.com.
- **REACH Compliance**
REACH substances of high concern (SVHCs) information is available for this product. Since the European Chemical Agency (ECHA) has published notice of their intent to frequently revise the SVHC listing for the foreseeable future, please contact a Cree representative to insure you get the most up-to-date REACH SVHC Declaration. REACH banned substance information (REACH Article 67) is also available upon request.
- This product has not been designed or tested for use in, and is not intended for use in, applications implanted into the human body nor in applications in which failure of the product could lead to death, personal injury or property damage, including but not limited to equipment used in the operation of nuclear facilities, life-support machines, cardiac defibrillators or similar emergency medical equipment, aircraft navigation or communication or control systems, air traffic control systems.

Related Links

- **SPICE Models:** <http://wolfspeed.com/power/tools-and-support>
- **SiC MOSFET Isolated Gate Driver reference design:** <http://wolfspeed.com/power/tools-and-support>
- **SiC MOSFET Evaluation Board:** <http://wolfspeed.com/power/tools-and-support>

X-ON Electronics

Largest Supplier of Electrical and Electronic Components

Click to view similar products for [MOSFET](#) category:

Click to view products by [Wolfspeed](#) manufacturer:

Other Similar products are found below :

[614233C](#) [648584F](#) [MCH3443-TL-E](#) [MCH6422-TL-E](#) [FDPF9N50NZ](#) [FW216A-TL-2W](#) [FW231A-TL-E](#) [APT5010JVR](#) [NTNS3A92PZT5G](#)
[IRF100S201](#) [JANTX2N5237](#) [2SK2464-TL-E](#) [2SK3818-DL-E](#) [FCA20N60_F109](#) [FDZ595PZ](#) [STD6600NT4G](#) [FSS804-TL-E](#) [2SJ277-DL-E](#)
[2SK1691-DL-E](#) [2SK2545\(Q,T\)](#) [D2294UK](#) [405094E](#) [423220D](#) [MCH6646-TL-E](#) [TPCC8103,L1Q\(CM](#) [367-8430-0972-503](#) [VN1206L](#)
[424134F](#) [026935X](#) [051075F](#) [SBVS138LT1G](#) [614234A](#) [715780A](#) [NTNS3166NZT5G](#) [751625C](#) [873612G](#) [IRF7380TRHR](#)
[IPS70R2K0CEAKMA1](#) [RJK60S3DPP-E0#T2](#) [RJK60S5DPK-M0#T0](#) [APT5010JVFR](#) [APT12031JFLL](#) [APT12040JVR](#) [DMN3404LQ-7](#)
[NTE6400](#) [JANTX2N6796U](#) [JANTX2N6784U](#) [JANTXV2N5416U4](#) [SQM110N05-06L-GE3](#) [SIHF35N60E-GE3](#)