

C6D08065E

Silicon Carbide Schottky Diode

Z-REC[®] RECTIFIER

V_{RRM}	=	650 V
$I_F (T_c=155^\circ\text{C})$	=	8 A
Q_c	=	29 nC

Features

- New 6th Generation Technology
- Low Forward Voltage Drop (V_F)
- Zero Reverse Recovery Current
- Zero Forward Recovery Voltage
- Low Leakage Current (I_L)
- Temperature-Independent Switching Behavior
- Positive Temperature Coefficient on V_F

Benefits

- Higher System Level Efficiency
- Increase System Power Density
- Reduction of Heat Sink Requirements
- Parallel Devices Without Thermal Runaway

Applications

- Switch Mode Power Supplies (SMPS)
- Server/Telecom Power Supplies
- Industrial Power Supplies
- Solar
- UPS

Package



TO-252-2



Part Number	Package	Marking
C6D08065E	TO-252-2	C6D08065

Maximum Ratings ($T_c = 25^\circ\text{C}$ unless otherwise specified)

Symbol	Parameter	Value	Unit	Test Conditions	Note
V_{RRM}	Repetitive Peak Reverse Voltage	650	V		
V_{DC}	DC Blocking Voltage	650	V		
I_F	Continuous Forward Current	29 15 8	A	$T_c=25^\circ\text{C}$ $T_c=125^\circ\text{C}$ $T_c=155^\circ\text{C}$	Fig. 3
I_{FRM}	Repetitive Peak Forward Surge Current	34 20	A	$T_c=25^\circ\text{C}, t_p = 10 \text{ ms}, \text{Half Sine Wave}$ $T_c=110^\circ\text{C}, t_p = 10 \text{ ms}, \text{Half Sine Wave}$	
I_{FSM}	Non-Repetitive Peak Forward Surge Current	63 57	A	$T_c=25^\circ\text{C}, t_p = 10 \text{ ms}, \text{Half Sine Wave}$ $T_c=110^\circ\text{C}, t_p = 10 \text{ ms}, \text{Half Sine Wave}$	Fig. 8
$I_{F,Max}$	Non-Repetitive Peak Forward Surge Current	781 717	A	$T_c=25^\circ\text{C}, t_p = 10 \mu\text{s}, \text{Pulse}$ $T_c=110^\circ\text{C}, t_p = 10 \mu\text{s}, \text{Pulse}$	Fig. 8
P_{tot}	Power Dissipation	85 37	W	$T_c=25^\circ\text{C}$ $T_c=110^\circ\text{C}$	Fig. 4
T_J, T_{stg}	Operating Junction and Storage Temperature	-55 to +175	$^\circ\text{C}$		

Electrical Characteristics

Symbol	Parameter	Typ.	Max.	Unit	Test Conditions	Note
V_F	Forward Voltage	1.27 1.37	1.50 1.60	V	$I_F = 8\text{ A}$ $T_J = 25^\circ\text{C}$ $I_F = 8\text{ A}$ $T_J = 175^\circ\text{C}$	Fig. 1
I_R	Reverse Current	2 15	40 160	μA	$V_R = 650\text{ V}$ $T_J = 25^\circ\text{C}$ $V_R = 650\text{ V}$ $T_J = 175^\circ\text{C}$	Fig. 2
Q_C	Total Capacitive Charge	29		nC	$V_R = 400\text{ V}$, $T_J = 25^\circ\text{C}$	Fig. 5
C	Total Capacitance	518 57 45		pF	$V_R = 0\text{ V}$, $T_J = 25^\circ\text{C}$, $f = 1\text{ MHz}$ $V_R = 200\text{ V}$, $T_J = 25^\circ\text{C}$, $f = 1\text{ MHz}$ $V_R = 400\text{ V}$, $T_J = 25^\circ\text{C}$, $f = 1\text{ MHz}$	Fig. 6
E_C	Capacitance Stored Energy	4.4		μJ	$V_R = 400\text{ V}$	Fig. 7

Note: This is a majority carrier diode, so there is no reverse recovery charge.

Thermal Characteristics

Symbol	Parameter	Typ.	Unit	Note
$R_{\theta JC}$	Thermal Resistance from Junction to Case	1.77	$^\circ\text{C}/\text{W}$	Fig. 9

Typical Performance

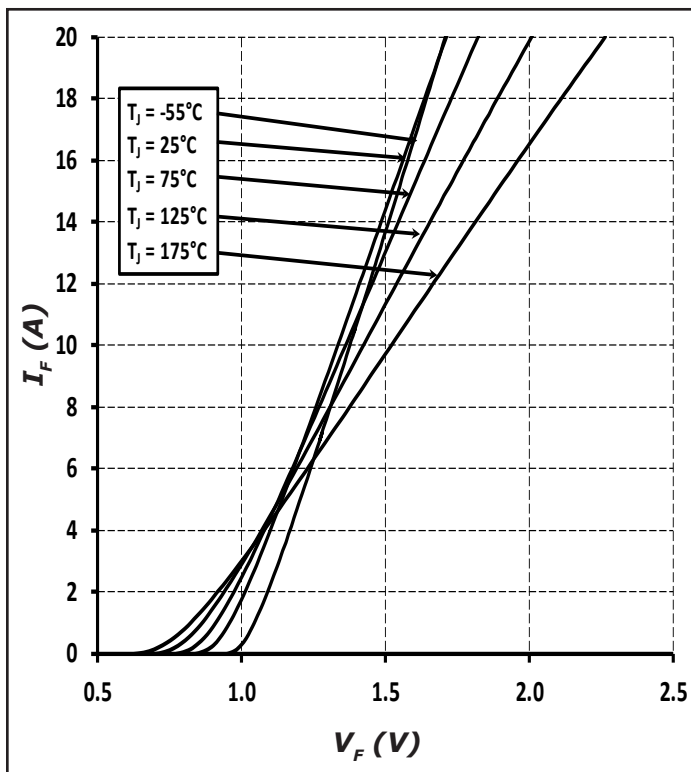

Figure 1. Forward Characteristics

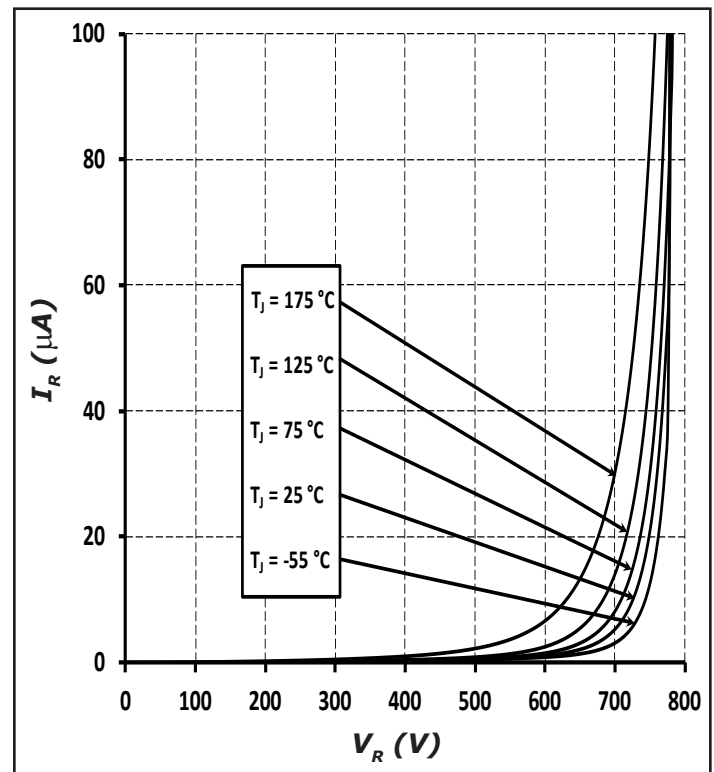

Figure 2. Reverse Characteristics

Typical Performance

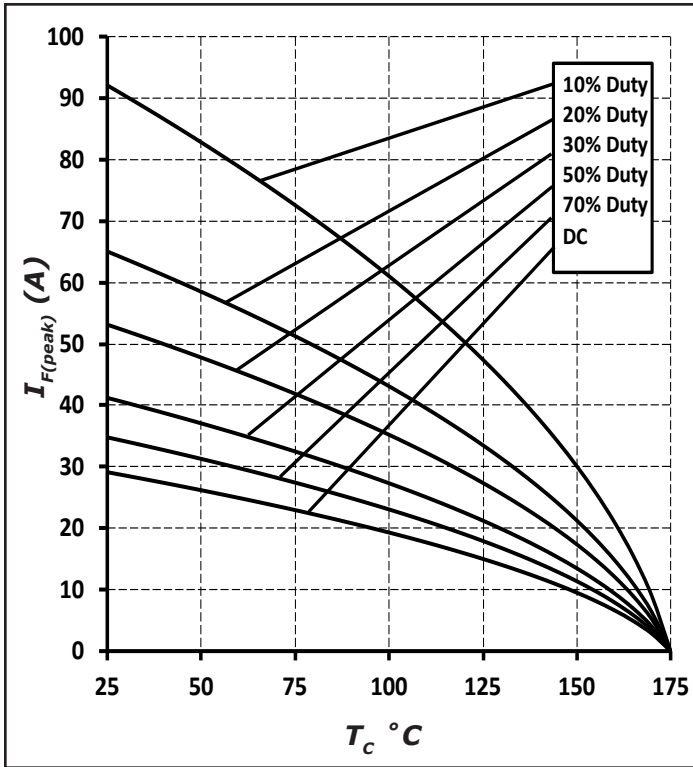

Figure 3. Current Derating

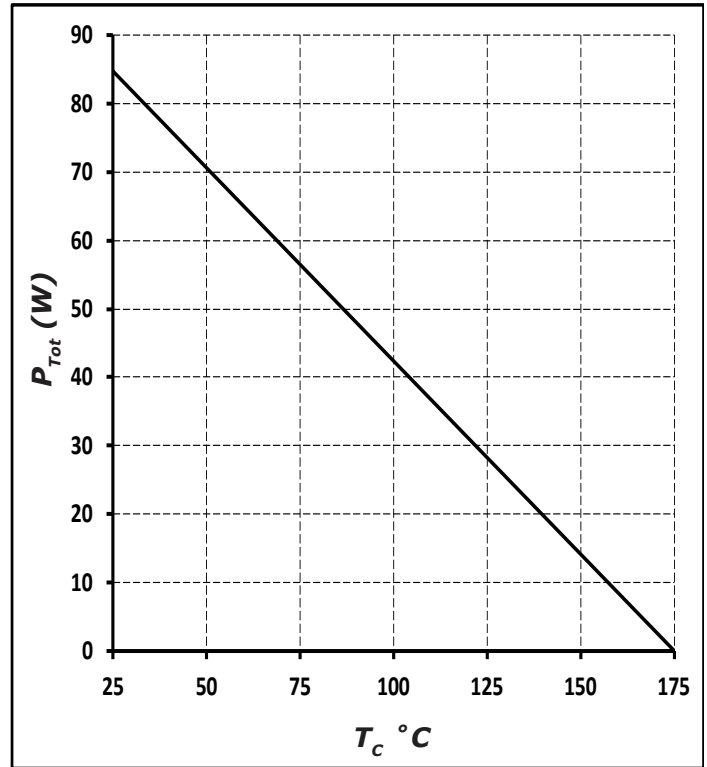

Figure 4. Power Derating

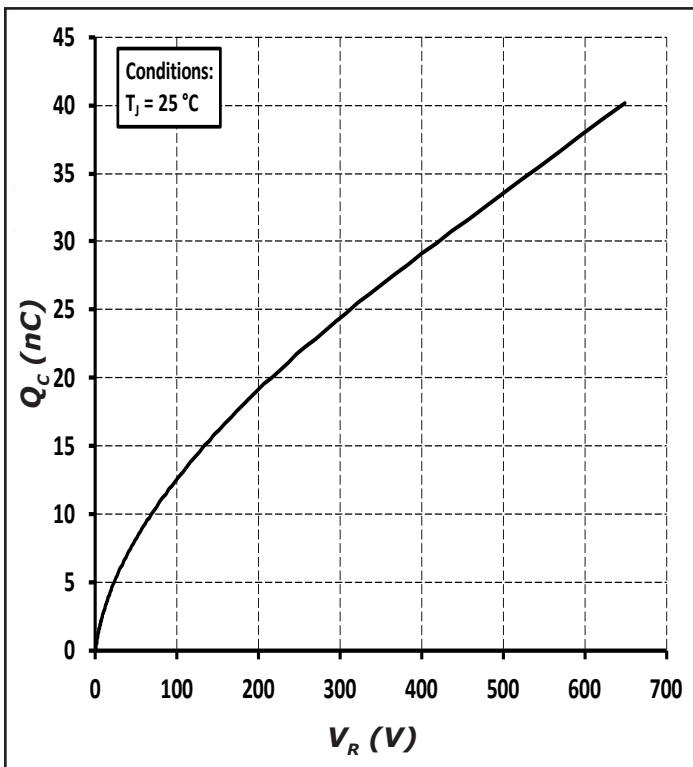

Figure 5. Total Capacitance Charge vs. Reverse Voltage

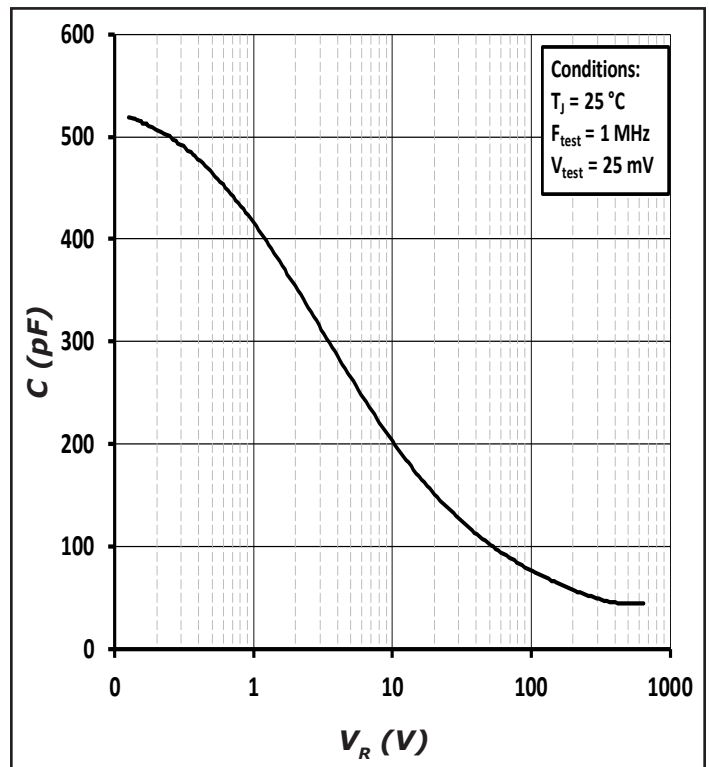

Figure 6. Capacitance vs. Reverse Voltage

Typical Performance

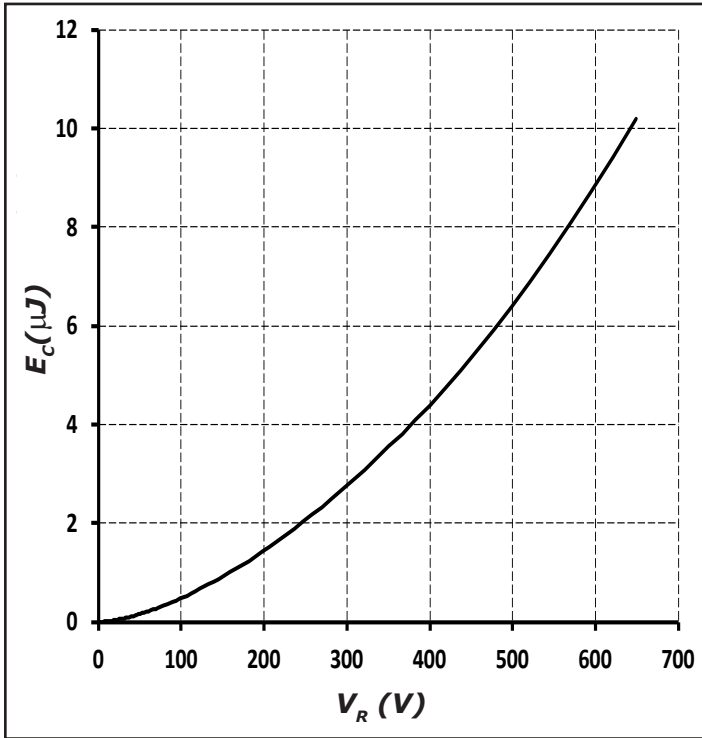

Figure 7. Capacitance Stored Energy

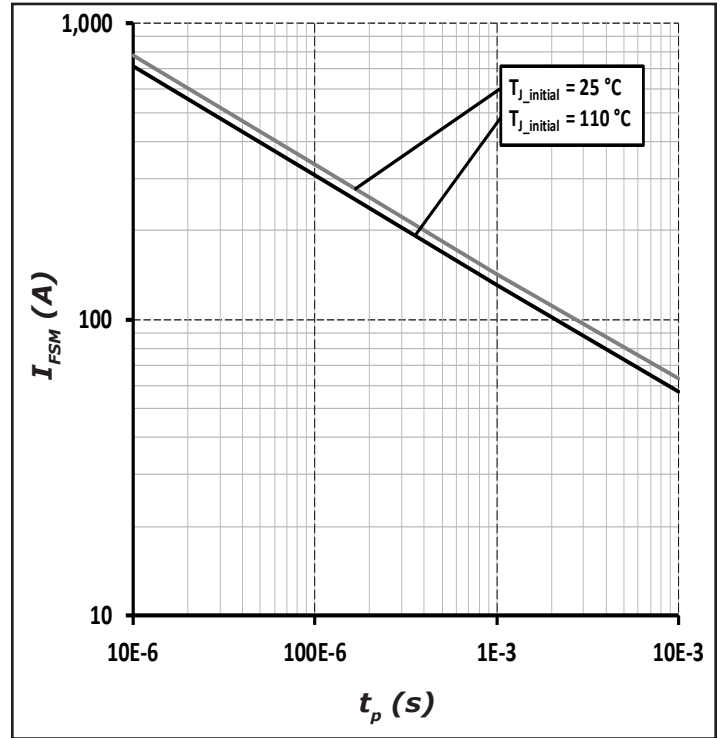

Figure 8. Non-repetitive peak forward surge current versus pulse duration (Sinusoidal Waveform)

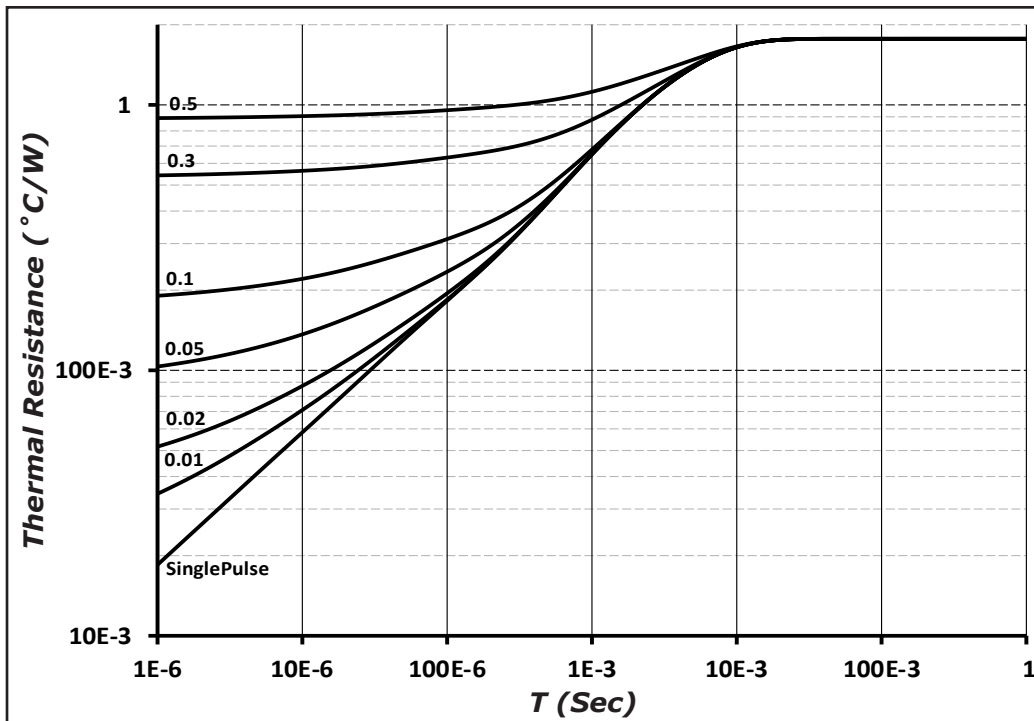
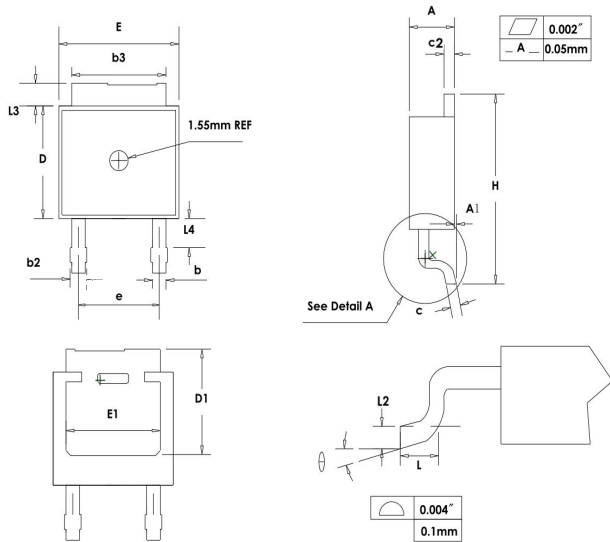

Figure 9. Transient Thermal Impedance

Package Dimensions

Package TO-252-2



SYMBOL	MILLIMETERS	
	MIN	MAX
A	2.159	2.413
A1	0	0.13
b	0.64	0.89
b2	0.653	1.143
b3	5.004	5.6
c	0.457	0.61
c2	0.457	0.864
D	5.867	6.248
D1	5.21	-
E	6.35	6.73
E1	4.32	-
e	4.58 BSC	
H	9.65	10.414
L	1.106	1.78
L2	0.51 BSC	
L3	0.889	1.27
L4	0.64	1.01
θ	0°	8°

Recommended Solder Pad Layout

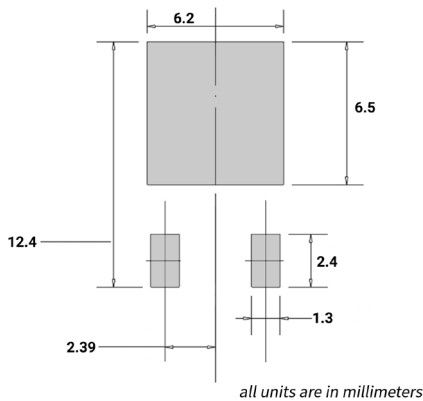

TO-252-2

Part Number	Package	Marking
C6D08065E	TO-252-2	C6D08065

Note: Recommended soldering profiles can be found in the applications note here:
http://www.wolfspeed.com/power_app_notes/soldering



Notes

- **RoHS Compliance**

The levels of RoHS restricted materials in this product are below the maximum concentration values (also referred to as the threshold limits) permitted for such substances, or are used in an exempted application, in accordance with EU Directive 2011/65/EC (RoHS2), as implemented January 2, 2013. RoHS Declarations for this product can be obtained from your Wolfspeed representative or from the Product Ecology section of our website at <http://www.wolfspeed.com/power/tools-and-support/product-ecology>.

- **REACH Compliance**

REACH substances of high concern (SVHCs) information is available for this product. Since the European Chemical Agency (ECHA) has published notice of their intent to frequently revise the SVHC listing for the foreseeable future, please contact a Cree representative to insure you get the most up-to-date REACH SVHC Declaration. REACH banned substance information (REACH Article 67) is also available upon request.

- This product has not been designed or tested for use in, and is not intended for use in, applications implanted into the human body nor in applications in which failure of the product could lead to death, personal injury or property damage, including but not limited to equipment used in the operation of nuclear facilities, life-support machines, cardiac defibrillators or similar emergency medical equipment, aircraft navigation or communication or control systems, or air traffic control systems.

Related Links

- Cree SiC Schottky diode portfolio: <http://www.wolfspeed.com/Power/Products#SiCSchottkyDiodes>
- Schottky diode Spice models: <http://www.wolfspeed.com/power/tools-and-support/DIODE-model-request2>
- SiC MOSFET and diode reference designs: <http://go.pardot.com/l/101562/2015-07-31/349i>

X-ON Electronics

Largest Supplier of Electrical and Electronic Components

Click to view similar products for [Schottky Diodes & Rectifiers](#) category:

Click to view products by [Wolfspeed](#) manufacturer:

Other Similar products are found below :

[MA4E2039](#) [MMBD301M3T5G](#) [RB160M-50TR](#) [D83C](#) [BAS16E6433HTMA1](#) [BAS 3010S-02LRH E6327](#) [BAT 54-02LRH E6327](#)
[NRVBAF360T3G](#) [NSR05F40QNXT5G](#) [NTE555](#) [JANS1N6640](#) [SS3003CH-TL-E](#) [GA01SHT18](#) [CRS10I30A\(TE85L,QM](#) [MBRA140TRPBF](#)
[MBRB30H30CT-1G](#) [BAT 15-04R E6152](#) [JANTX1N5712-1](#) [DMJ3940-000](#) [SB007-03C-TB-E](#) [NRVBB20100CTT4G](#) [NRVBM120LT1G](#)
[NTSB30U100CT-1G](#) [CRG04\(T5L,TEMQ\)](#) [ACDBA1100LR-HF](#) [ACDBA1200-HF](#) [ACDBA240-HF](#) [ACDBA3100-HF](#) [CDBQC0530L-HF](#)
[ACDBA260LR-HF](#) [ACDBA1100-HF](#) [10BQ015-M3/5BT](#) [NRVBM120ET1G](#) [VSSB410S-M3/5BT](#) [1N5819T-G](#) [PDS1040Q-13](#) [B160BQ-13-F](#)
[SDM05U20CSP-7](#) [BAS 70-07 E6433](#) [B140S1F-7](#) [HSM560Je3/TR13](#) [DDB2265-000](#) [ZHCS506QTA](#) [HSM190Je3/TR13](#) [B330AF-13](#)
[ACDBUC0230-HF](#) [SDM1U100S1F-7](#) [MBR10200CTF-G1](#) [CDLL5712](#) [DMF2822-000](#)