

# CGH40180PP

180 W, RF Power GaN HEMT

## Description

Cree's CGH40180PP is an unmatched, gallium nitride (GaN) high electron mobility transistor (HEMT). The CGH40180PP, operating from a 28 volt rail, offers a general purpose, broadband solution to a variety of RF and microwave applications. GaN HEMTs offer high efficiency, high gain and wide bandwidth capabilities making the CGH40180PP ideal for linear and compressed amplifier circuits. The transistor is available in a 4-lead flange package.

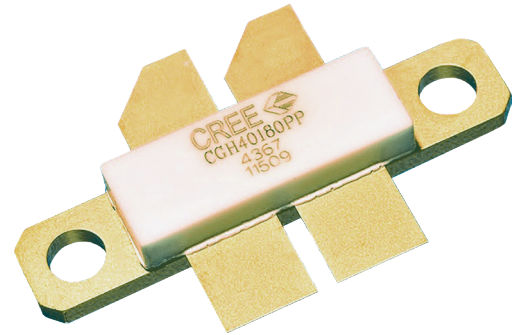

Package Types: 440199  
PN: CGH40180PP

## Features

- Up to 2.5 GHz Operation
- 20 dB Small Signal Gain at 1.0 GHz
- 15 dB Small Signal Gain at 2.0 GHz
- 220 W typical  $P_{SAT}$
- 70% Efficiency at  $P_{SAT}$
- 28 V Operation

## Applications

- 2-Way Private Radio
- Broadband Amplifiers
- Cellular Infrastructure
- Test Instrumentation
- Class A, AB, Linear amplifiers suitable for OFDM, W-CDMA, EDGE, CDMA waveforms

 Large Signal Models Available for ADS and MWO

**RoHS**  
COMPLIANT



## Absolute Maximum Ratings (not simultaneous) at 25 °C Case Temperature

Parameter	Symbol	Rating	Units	Conditions
Drain-Source Voltage	$V_{DS}$	120	Volts	25 °C
Gate-to-Source Voltage	$V_{GS}$	-10, +2	Volts	25 °C
Storage Temperature	$T_{STG}$	-65, +150	°C	
Operating Junction Temperature	$T_J$	225	°C	
Maximum Forward Gate Current	$I_{GMAX}$	60	mA	25 °C
Maximum Drain Current <sup>1</sup>	$I_{DMAX}$	24	A	25 °C
Soldering Temperature <sup>2</sup>	$T_S$	245	°C	
Screw Torque	$\tau$	40	in-oz	
Thermal Resistance, Junction to Case <sup>3</sup>	$R_{\theta JC}$	0.9	°C/W	85 °C
Case Operating Temperature <sup>3,4</sup>	$T_C$	-40, +85	°C	

Notes:

<sup>1</sup> Current limit for long term, reliable operation

<sup>2</sup> Refer to the Application Note on soldering at [wolfspeed.com/RF/Document-Library](http://wolfspeed.com/RF/Document-Library)

<sup>3</sup> CGH40180PP at  $P_{DISS} = 224$  W

<sup>4</sup> See also, the Power Dissipation De-rating Curve on Page 6

## Electrical Characteristics ( $T_C = 25$ °C)

Characteristics	Symbol	Min.	Typ.	Max.	Units	Conditions
<b>DC Characteristics<sup>1</sup></b>						
Gate Threshold Voltage	$V_{GS(th)}$	-3.8	-3.0	-2.3	$V_{DC}$	$V_{DS} = 10$ V, $I_D = 57.6$ mA
Gate Quiescent Voltage	$V_{GS(Q)}$	-	-2.7	-	$V_{DC}$	$V_{DS} = 28$ V, $I_D = 2.0$ A
Saturated Drain Current <sup>2</sup>	$I_{DS}$	40.3	56.4	-	A	$V_{DS} = 6.0$ V, $V_{GS} = 2.0$ V
Drain-Source Breakdown Voltage	$V_{BR}$	84	-	-	$V_{DC}$	$V_{GS} = -8$ V, $I_D = 57.6$ mA
<b>RF Characteristics<sup>3,4</sup> (<math>T_C = 25</math> °C, <math>F_0 = 1.3</math> GHz unless otherwise noted)</b>						
Power Gain	$P_G$	13	-	-	dB	$V_{DD} = 28$ V, $I_{DQ} = 2.0$ A, $P_{OUT} = P_{SAT}$
Small Signal Gain	$G_{SS}$	-	19	-	dB	$V_{DD} = 28$ V, $I_{DQ} = 2.0$ A
Power Output at Saturation <sup>5</sup>	$P_{SAT}$	180	220	-	W	$V_{DD} = 28$ V, $I_{DQ} = 2.0$ A
Drain Efficiency <sup>6</sup>	$\eta$	56	65	-	%	$V_{DD} = 28$ V, $I_{DQ} = 2.0$ A, $P_{OUT} = P_{SAT}$
Output Mismatch Stress	VSWR	-	-	10 : 1	$\Psi$	No damage at all phase angles, $V_{DD} = 28$ V, $I_{DQ} = 2.0$ A, $P_{OUT} = 180$ W CW
<b>Dynamic Characteristics<sup>7</sup></b>						
Input Capacitance	$C_{GS}$	-	35.7	-	pF	$V_{DS} = 28$ V, $V_{GS} = -8$ V, $f = 1$ MHz
Output Capacitance	$C_{DS}$	-	9.6	-	pF	$V_{DS} = 28$ V, $V_{GS} = -8$ V, $f = 1$ MHz
Feedback Capacitance	$C_{GD}$	-	1.6	-	pF	$V_{DS} = 28$ V, $V_{GS} = -8$ V, $f = 1$ MHz

Notes:

<sup>1</sup> Measured on wafer prior to packaging

<sup>2</sup> Scaled from PCM data

<sup>3</sup> Measured in CGH40180PP-AMP, including all coupler losses

<sup>4</sup>  $I_{DQ}$  of 2.0 A is by biasing each device at 1.0 A

<sup>5</sup>  $P_{SAT}$  is defined as: Q1 or Q2 =  $I_G = 2.8$  mA

<sup>6</sup> Drain Efficiency =  $P_{OUT} / P_{DC}$

<sup>7</sup> Capacitance values are for each side of the device



Typical Performance

**Gain and Return Loss vs Frequency measured in Broadband Amplifier Circuit CGH40180PP-AMP**  
 $V_{DD} = 28\text{ V}, I_{DQ} = 2.0\text{ A}$

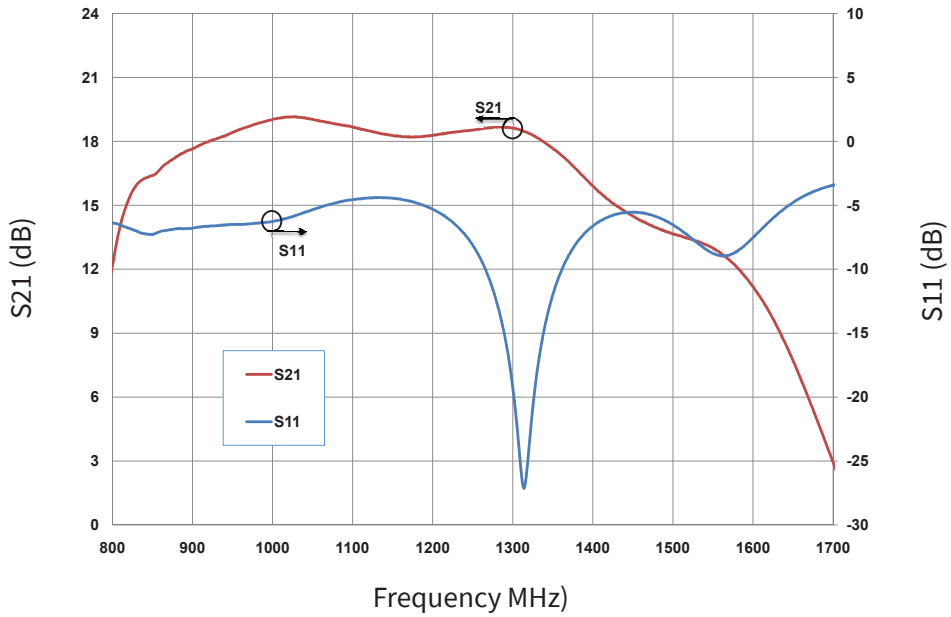

**Output Power and Drain Efficiency vs Frequency measured in Broadband Amplifier Circuit CGH40180PP-AMP**  
 $V_{DD} = 28\text{ V}, I_{DQ} = 2.0\text{ A}$

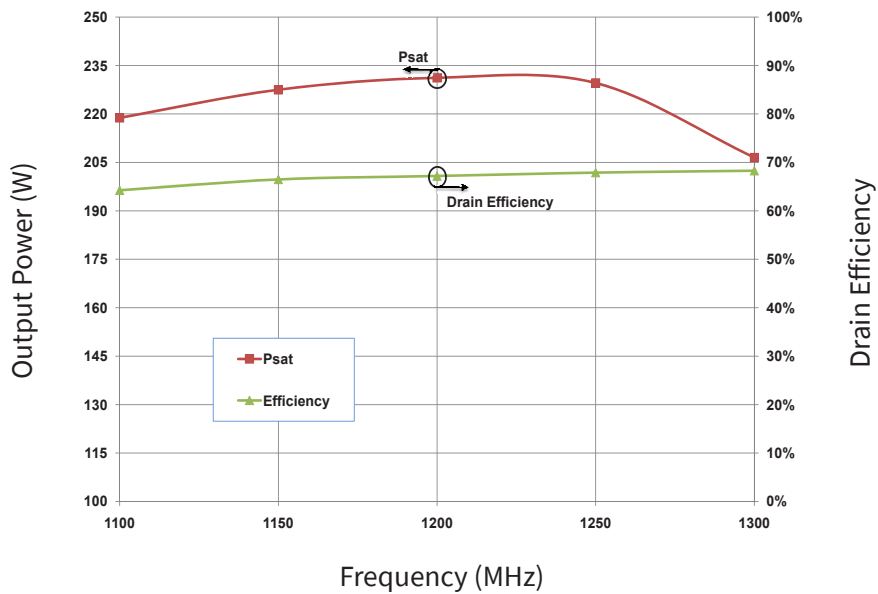

### Typical Performance

**Gain and Drain Efficiency vs Output Power measured in Broadband Amplifier Circuit CGH40180PP-AMP**  
 $V_{DD} = 28\text{ V}, I_{DQ} = 2.0\text{ A}$

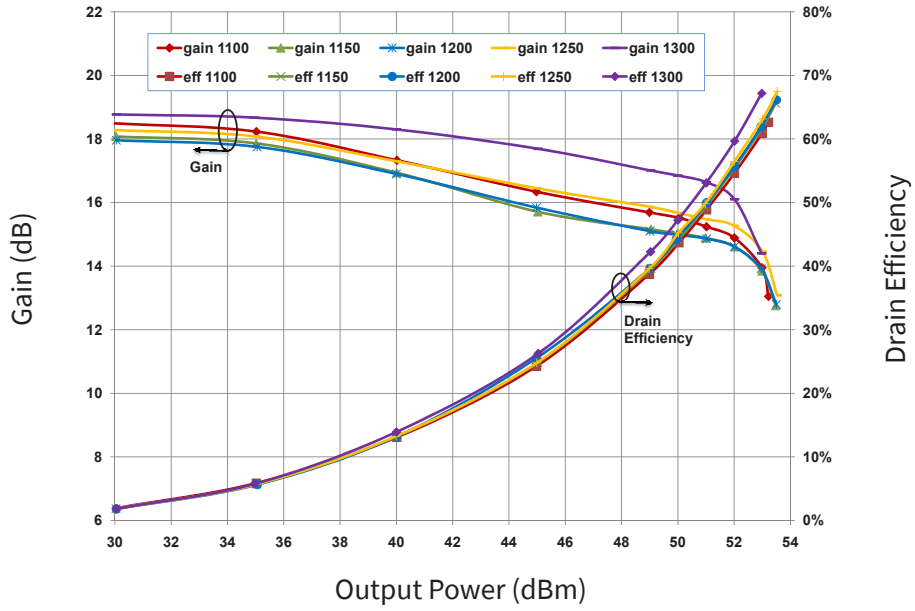



**Typical Performance**

**Simulated Maximum Available Gain and K Factor of the CGH40180PP**

$V_{DD} = 28\text{ V}, I_{DQ} = 1.0\text{ A}$

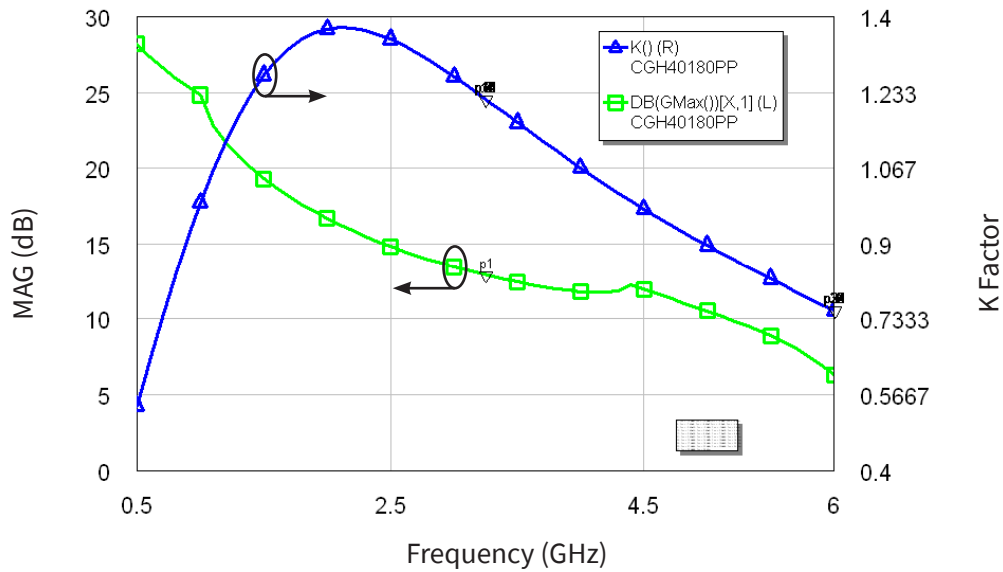

**Typical Noise Performance**

**Simulated Minimum Noise Figure and Noise Resistance vs Frequency of the CGH40180PP**

$V_{DD} = 28\text{ V}, I_{DQ} = 1\text{ A}$

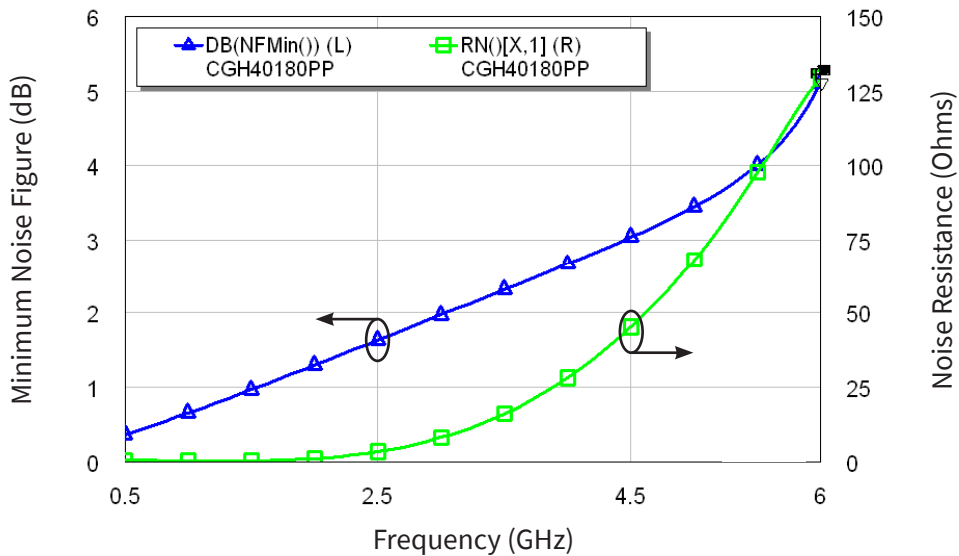

**Electrostatic Discharge (ESD) Classifications**

Parameter	Symbol	Class	Test Methodology
Human Body Model	HBM	1A > 250 V	JEDEC JESD22 A114-D
Charge Device Model	CDM	1 < 200 V	JEDEC JESD22 C101-C



### CGH40180PP Power Dissipation De-rating Curve

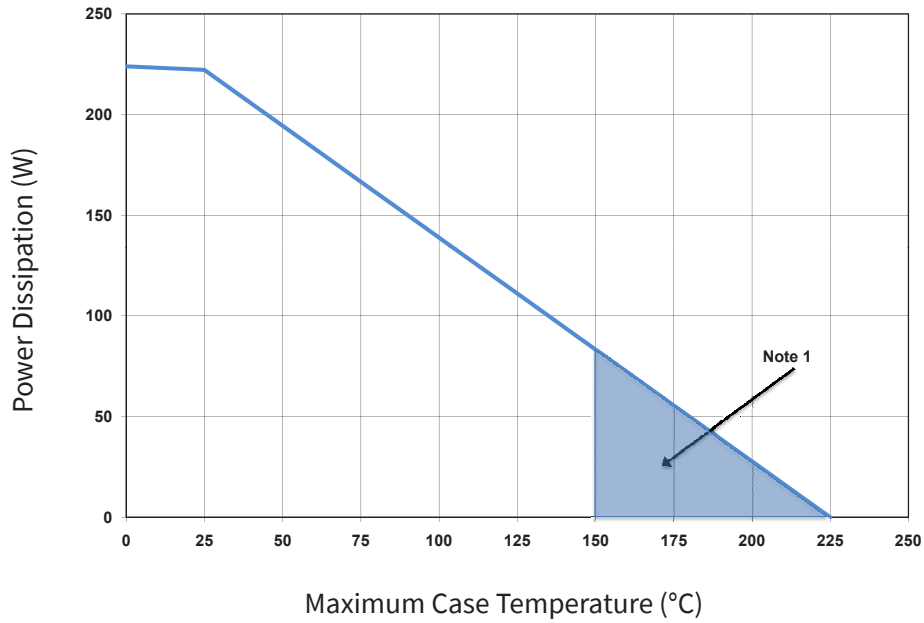

Note 1. Area exceeds Maximum Case Operating Temperature (See Page 2)

### CGH40180PP Transient Power Dissipation De-rating Curve

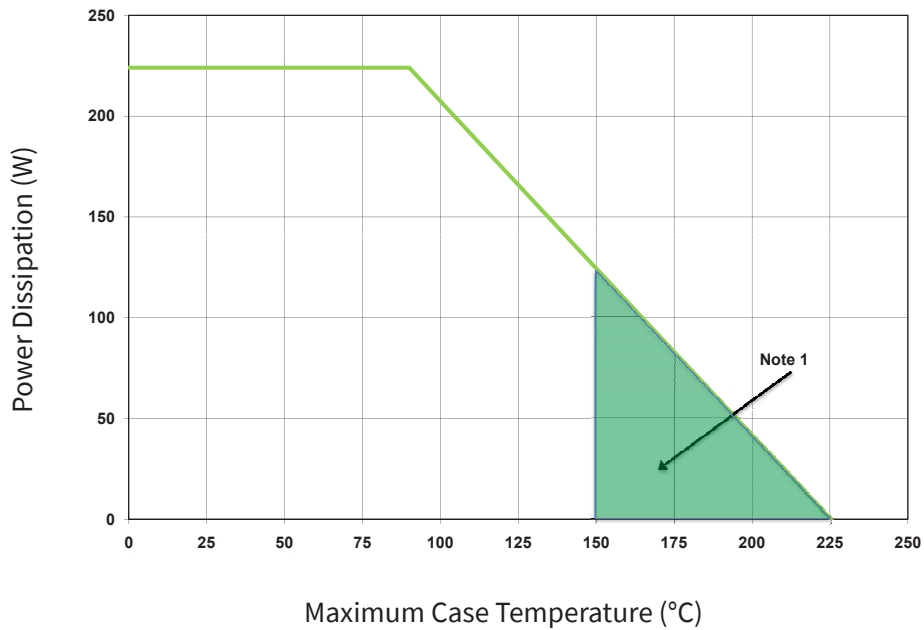

Note 1. Area exceeds Maximum Case Operating Temperature (See Page 2)

Note 2. This transient de-rating curve assumes a 1msec pulse with a 20% duty cycle with no power dissipated during the “off-cycle”



### Thermal Resistance as a Function of Pulse Width

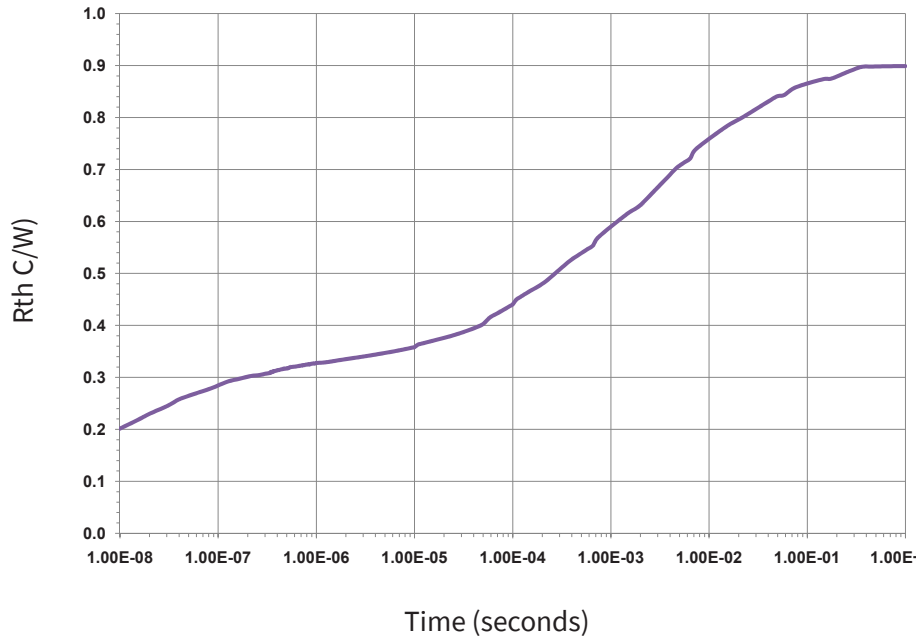

Note 1. This heating curve assumes zero power dissipation during the “off” portion of the duty cycle  
 Note 2. This data is for transient power dissipation at 224 W, Duty Cycle = 20%

### Simulated Source and Load Impedances

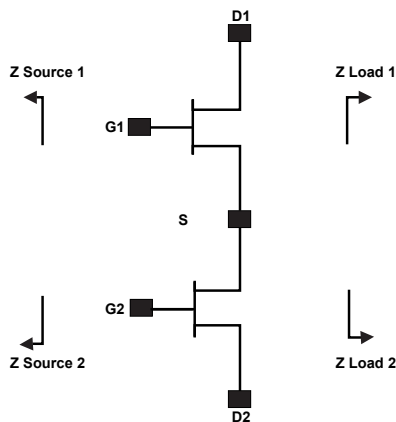

Frequency (MHz)	Z Source	Z Load
500	2.85 + j1.99	5.27 + j0.68
1000	0.8 + j0.42	4.91 + j0.36
1500	0.84 - j1.69	4.65 - j0.24
2000	0.88 - j3.05	2.8 - j1.05
2500	1.08 - j4.5	3.1 - j2.47
3000	1.25 - j6.06	3.1 - j4.01

Note 1.  $V_{DD} = 28V$ ,  $I_{DQ} = 2.0 A$  in the 440199 package  
 Note 2. Optimized for power, gain,  $P_{SAT}$  and PAE  
 Note 3. When using this device at low frequency, series resistors should be used to maintain amplifier stability

### CGH40180PP-AMP Demonstration Amplifier Circuit Schematic

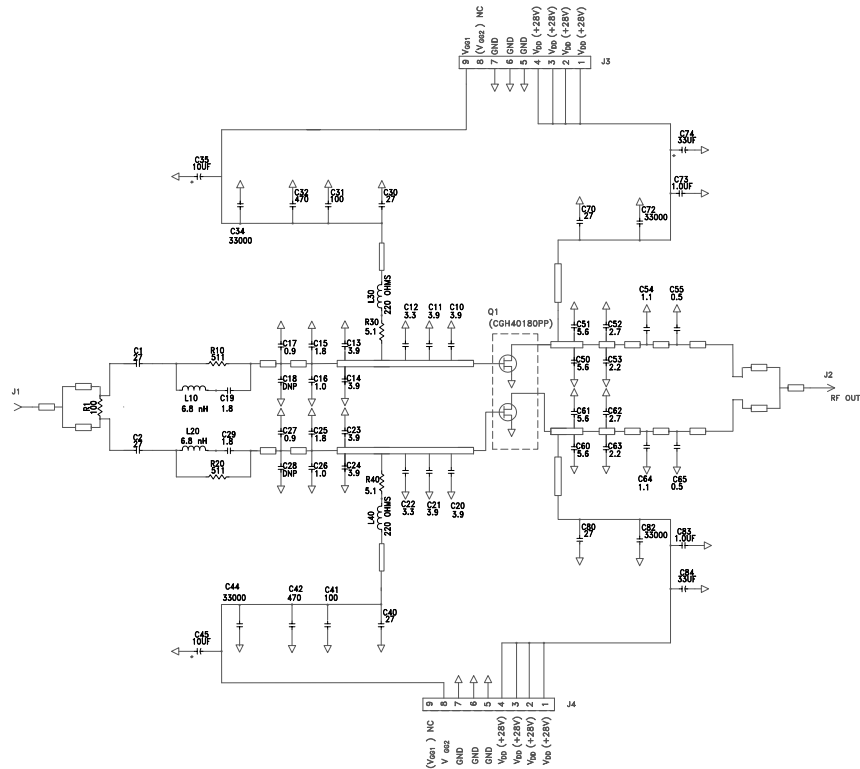

### CGH40180PP-AMP Demonstration Amplifier Circuit Outline

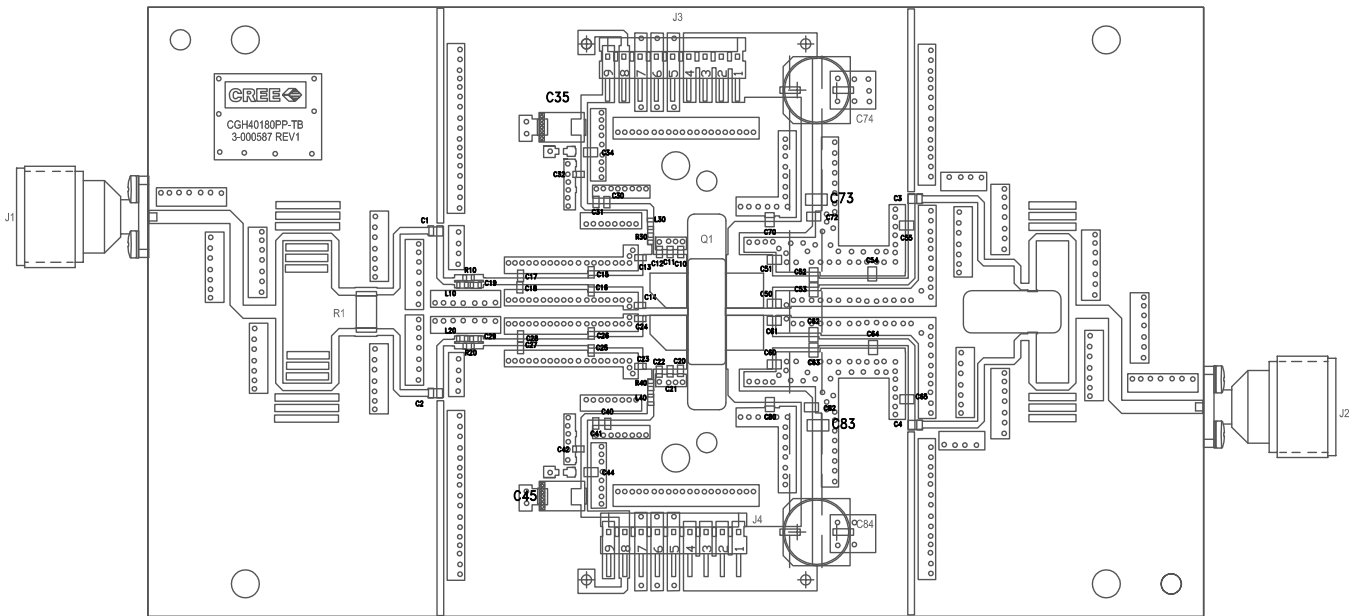



## CGH40180PP-AMP Demonstration Amplifier Circuit Bill of Materials

Designator	Description	Qty
R1	RES, 100 Ohm, +/-1%, 1 W, 2512	1
R10, R20	RES, 511 Ohm, +/- 5%, 1/16W, 0603	2
R30, R40	RES, 1/16W, 0603, 1%, 5.1 OHMS	2
C1, C2, C3, C4, C30, C40, C70, C80	CAP, 27 pF,+/-5% 0805,ATC600F	8
C10, C11, C13, C14, C20, C21, C23, C24	CAP, 3.9PF, +/-0.1 pF, 0603, ATC600S	8
C12, C22	CAP, 3.3PF, +/-0.1 pF, 0603, ATC600S	2
C15, C19, C25, C29	CAP, 3.3PF, +/-0.1 pF, 0603, ATC600S	4
C16, C26	CAP, 1.0PF, +/-0.1 pF, 0603, ATC600S	2
C17, C27	CAP, 0.9PF, +/-0.1 pF, 0603, ATC600S	2
C31, C41	CAP, 100 pF,+/-5%, 0603,ATC600S	2
C32, C42	CAP, 470 pF, 5%, 100V, 0603, X7R	2
C34, C44, C72, C82	CAP, 33000 pF, 0805, 100V, X7R	4
C35, C45	CAP, 10 uF, 16V, TANTALUM	2
C50, C51, C60, C61	CAP, 5.6 pF, +/-0.1 pF, 0805, ATC600F	4
C52, C62	CAP, 2.7 pF, +/-0.1 pF, 0805, ATC600F	2
C53, C63	CAP, 2.2 pF, +/-0.1 pF, 0805, ATC600F	2
C54, C64	CAP, 1.1 pF, +/-0.05 pF, 0805, ATC600F	2
C55, C65	CAP, 0.5 pF, +/-0.05 pF, 0805, ATC600F	2
C73, C83	CAP, 1.0 uF, +/-10%, 1210, 100V, X7R	2
C74, C84	CAP, 33 uF, 100V, ELECT, FK, SMD	2
L10, L20	IND, 6.8 nH, 0603, L-14C6N8ST	2
L30, L40	FERRITE, 220 OHM, 0603, BLM21PG221SN1	2
J1, J2	CONN, N-Type, Female, 0.500 SMA Flange	2
J3, J4	CONN, Header, RT> PLZ, 0.1 CEN, LK, 9 POS	2
-	PCB, RO4350, Er = 3.48, h = 20 mil	1
Q1	CGH40180PP	1

## CGH40180PP-AMP Demonstration Amplifier Circuit

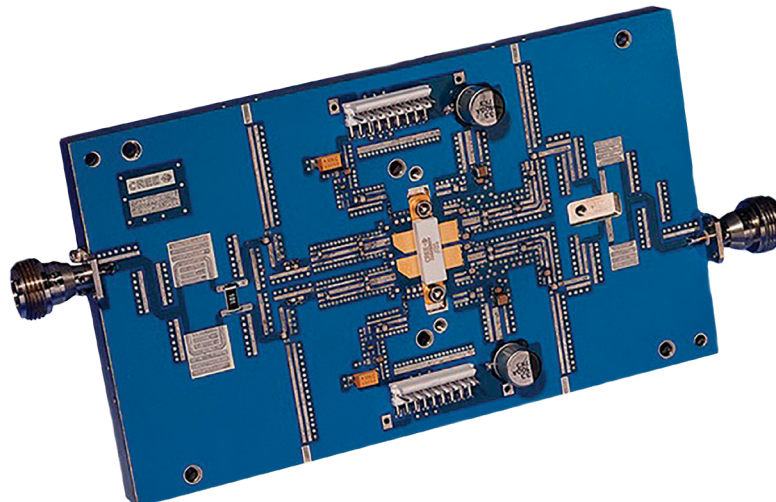

**Typical Package S-Parameters for CGH40180PP, Single Side**  
**(Small Signal,  $V_{DS} = 28\text{ V}$ ,  $I_{DQ} = 1000\text{ mA}$ , angle in degrees)**

Frequency	Mag S11	Ang S11	Mag S21	Ang S21	Mag S12	Ang S12	Mag S22	Ang S22
500 MHz	0.957	-177.48	4.22	79.26	0.007	10.74	0.798	-179.16
600 MHz	0.957	-178.74	3.51	76.30	0.007	12.14	0.800	-179.41
700 MHz	0.957	-179.78	3.00	73.47	0.007	13.71	0.802	-179.63
800 MHz	0.957	179.32	2.62	70.74	0.007	15.38	0.804	-179.84
900 MHz	0.957	178.51	2.33	68.08	0.007	17.15	0.807	179.96
1.0 GHz	0.957	177.76	2.09	65.49	0.007	18.99	0.809	179.74
1.1 GHz	0.957	177.06	1.90	62.95	0.007	20.87	0.812	179.52
1.2 GHz	0.957	176.38	1.73	60.46	0.007	22.80	0.814	179.28
1.3 GHz	0.957	175.72	1.60	58.02	0.008	24.73	0.817	179.03
1.4 GHz	0.956	175.08	1.48	55.63	0.008	26.66	0.820	178.76
1.5 GHz	0.956	174.44	1.38	53.29	0.008	28.57	0.823	178.46
1.6 GHz	0.956	173.81	1.29	50.98	0.008	30.44	0.825	178.15
1.7 GHz	0.956	173.18	1.22	48.72	0.008	32.25	0.828	177.82
1.8 GHz	0.955	172.55	1.15	46.50	0.009	33.98	0.831	177.47
1.9 GHz	0.955	171.91	1.09	44.32	0.009	35.62	0.833	177.10
2.0 GHz	0.955	171.27	1.04	42.17	0.009	37.17	0.835	176.71
2.1 GHz	0.954	170.62	0.99	40.06	0.010	38.61	0.838	176.30
2.2 GHz	0.954	169.96	0.95	37.98	0.010	39.93	0.840	175.87
2.3 GHz	0.953	169.29	0.91	35.93	0.011	41.14	0.842	175.42
2.4 GHz	0.952	168.60	0.87	33.91	0.011	42.22	0.844	174.95
2.5 GHz	0.952	167.90	0.84	31.92	0.012	43.18	0.845	174.47
2.6 GHz	0.951	167.18	0.82	29.95	0.013	44.01	0.847	173.96
2.7 GHz	0.950	166.45	0.79	28.00	0.013	44.73	0.848	173.44
2.8 GHz	0.949	165.69	0.77	26.07	0.014	45.32	0.849	172.89
2.9 GHz	0.948	164.91	0.75	24.15	0.015	45.79	0.850	172.33
3.0 GHz	0.946	164.10	0.73	22.24	0.016	46.15	0.850	171.74
3.2 GHz	0.943	162.39	0.71	18.45	0.018	46.53	0.851	170.51
3.4 GHz	0.939	160.55	0.69	14.64	0.020	46.47	0.850	169.19
3.6 GHz	0.935	158.53	0.67	10.80	0.023	45.97	0.848	167.76
3.8 GHz	0.929	156.31	0.67	6.86	0.027	45.03	0.845	166.21
4.0 GHz	0.922	153.83	0.67	2.78	0.031	43.63	0.841	164.53
4.2 GHz	0.913	151.03	0.68	-1.51	0.036	41.72	0.834	162.69
4.4 GHz	0.901	147.82	0.69	-6.12	0.042	39.23	0.825	160.65
4.6 GHz	0.886	144.10	0.72	-11.16	0.049	36.07	0.813	158.39
4.8 GHz	0.866	139.68	0.76	-16.81	0.059	32.05	0.797	155.86
5.0 GHz	0.838	134.36	0.81	-23.30	0.073	26.92	0.775	153.00
5.2 GHz	0.799	127.78	0.88	-30.99	0.091	20.30	0.747	149.76
5.4 GHz	0.742	119.49	0.97	-40.41	0.117	11.55	0.708	146.16
5.6 GHz	0.658	108.92	1.08	-52.33	0.157	-0.34	0.657	142.31
5.8 GHz	0.534	95.85	1.21	-67.76	0.219	-16.90	0.594	138.62
6.0 GHz	0.373	82.93	1.34	-87.69	0.321	-40.38	0.534	134.70

To download the s-parameters in s2p format, go to the [CGH40180PP](#) Product page and click on the documentation tab.

**Product Dimensions CGH40180PP (Package Type – 440199)**

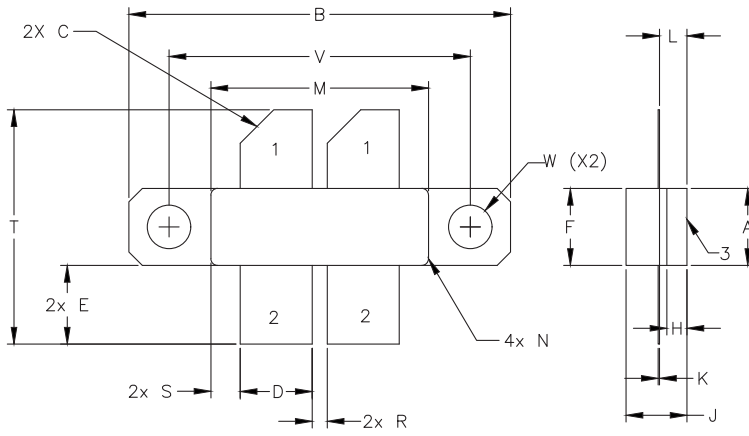

DIM	INCHES		MILLIMETERS	
	MIN	MAX	MIN	MAX
A	0.225	0.235	5.72	5.97
B	1.135	1.145	28.83	29.00
C	0.10	45° REF	2.54	45° REF
D	0.210	0.220	5.33	5.59
E	0.230	0.240	5.84	6.00
F	0.225	0.235	5.71	5.97
H	0.055	0.065	1.40	1.65
J	0.174	0.208	3.87	4.37
K	0.003	0.006	0.08	0.15
L	0.075	0.085	1.91	2.16
M	0.643	0.657	16.30	16.70
N	R.010 REF		R0.51 REF	
R	0.040	0.050	1.00	1.27
S	0.083	0.093	2.10	2.36
T	0.680	0.720	17.30	18.30
V	0.895	0.905	22.70	22.98
W		ø.130		ø 3.30

**Part Number System**

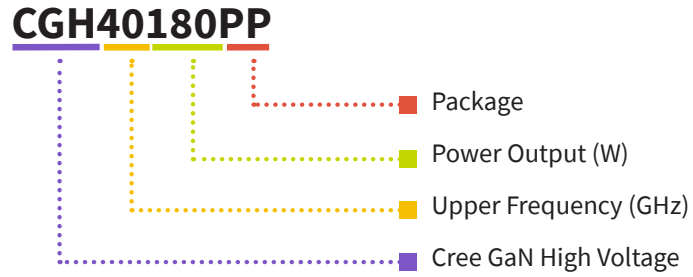

**Table 1.**

Parameter	Value	Units
Upper Frequency <sup>1</sup>	2.5	GHz
Power Output	180	W
Package	Push Pill	-

**Note<sup>1</sup>:** Alpha characters used in frequency code indicate a value greater than 9.9 GHz. See Table 2 for value

**Table 2.**

Character Code	Code Value
A	0
B	1
C	2
D	3
E	4
F	5
G	6
H	7
J	8
K	9
Examples:	1A = 10.0 GHz 2H = 27.0 GHz

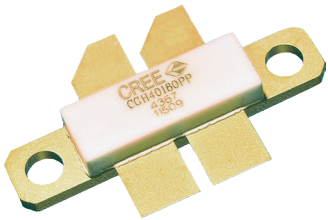
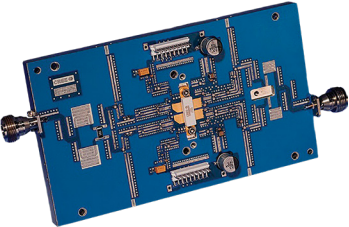

**Product Ordering Information**

Order Number	Description	Unit of Measure	Image
CGH40180PP	GaN HEMT	Each	
CGH40180PP-AMP	Test board with GaN HEMT installed	Each	



For more information, please contact:

4600 Silicon Drive  
Durham, North Carolina, USA 27703  
[www.wolfspeed.com/RF](http://www.wolfspeed.com/RF)

Sales Contact  
[RFsales@cree.com](mailto:RFsales@cree.com)

## Notes

---

### Disclaimer

Specifications are subject to change without notice. “Typical” parameters are the average values expected by Cree in large quantities and are provided for information purposes only. Cree products are not warranted or authorized for use as critical components in medical, life-saving, or life-sustaining applications, or other applications where a failure would reasonably be expected to cause severe personal injury or death. No responsibility is assumed by Cree for any infringement of patents or other rights of third parties which may result from use of the information contained herein. No license is granted by implication or otherwise under any patent or patent rights of Cree.

## X-ON Electronics

Largest Supplier of Electrical and Electronic Components

*Click to view similar products for [RF Development Tools](#) category:*

*Click to view products by [Wolfspeed](#) manufacturer:*

Other Similar products are found below :

[MAAM-011117](#) [MAAP-015036-DIEEV2](#) [EV1HMC1113LP5](#) [EV1HMC6146BLC5A](#) [EV1HMC637ALP5](#) [EVAL-ADG919EBZ](#) [ADL5363-EVALZ](#) [LMV228SDEVAL](#) [SKYA21001-EVB](#) [SMP1331-085-EVB](#) [EV1HMC618ALP3](#) [EVAL01-HMC1041LC4](#) [MAAL-011111-000SMB](#)  
[MAAM-009633-001SMB](#) [107712-HMC369LP3](#) [107780-HMC322ALP4](#) [SP000416870](#) [EV1HMC470ALP3](#) [EV1HMC520ALC4](#)  
[EV1HMC244AG16](#) [MAX2614EVKIT#](#) [124694-HMC742ALP5](#) [SC20ASATEA-8GB-STD](#) [MAX2837EVKIT+](#) [MAX2612EVKIT#](#)  
[MAX2692EVKIT#](#) [SKY12343-364LF-EVB](#) [108703-HMC452QS16G](#) [EV1HMC863ALC4](#) [EV1HMC427ALP3E](#) [119197-HMC658LP2](#)  
[EV1HMC647ALP6](#) [ADL5725-EVALZ](#) [106815-HMC441LM1](#) [EV1HMC1018ALP4](#) [UXN14M9PE](#) [MAX2016EVKIT](#) [EV1HMC939ALP4](#)  
[MAX2410EVKIT](#) [MAX2204EVKIT+](#) [EV1HMC8073LP3D](#) [SIMSA868-DKL](#) [SIMSA868C-DKL](#) [SKY65806-636EK1](#) [SKY68020-11EK1](#)  
[SKY67159-396EK1](#) [SKY66181-11-EK1](#) [SKY65804-696EK1](#) [SKY13396-397LF-EVB](#) [SKY13380-350LF-EVB](#)