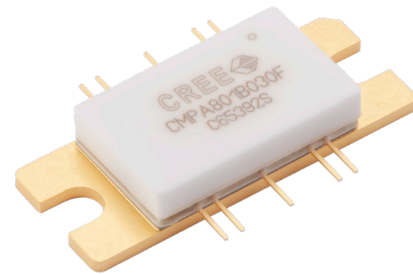


# CMPA801B030F

30 W, 8.0 – 11.0 GHz, GaN MMIC, Power Amplifiers

## Description

Wolfspeed's CMPA801B030F is a gallium nitride (GaN) High Electron Mobility Transistor (HEMT) based monolithic microwave integrated circuit (MMIC). GaN has superior properties compared to silicon or gallium arsenide, including higher breakdown voltage, higher saturated electron drift velocity and higher thermal conductivity. GaN HEMTs also offer greater power density and wider bandwidths compared to Si and GaAs transistors. This MMIC is available in a 10-lead metal/ceramic flanged package for optimal electrical and thermal performance.



PN : CMPA801B030F  
Package Type : 440213

### Features

- 8.0 - 11.0 GHz Operation
- 37 W  $P_{OUT}$  typical
- 16 dB Power gain
- 36% Typical PAE
- 50 Ohm internally matched

### Applications

- Marine Radar
- Communications
- Satellite Communication Uplink

## Typical Performance Over 8.0 - 11.0 GHz ( $T_c = 85^\circ\text{C}$ )

Parameter	8.0 GHz	8.5 GHz	9.0 GHz	10.0 GHz	11.0 GHz	Units
Small Signal Gain	27	25	22	23	21	dB
Output Power <sup>1</sup>	31	30	28	25	24	W
Power Gain <sup>1</sup>	17	17	17	16	16	dB
Power Added Efficiency <sup>1</sup>	39	39	36	28	33	%

Note:

1. Measured in CMPA801B030F-AMP under  $P_{IN} = 28\text{ dBm}$ , 100  $\mu\text{s}$  pulse width, 10% duty.

**Absolute Maximum Ratings (not simultaneous)**

Parameter	Symbol	Rating	Units	Conditions
Drain-source Voltage	$V_{DSS}$	84	$V_{DC}$	25 °C
Gate-source Voltage	$V_{GS}$	-10, +2	$V_{DC}$	25 °C
Power Dissipation	$P_{DISS}$	77	W	
Storage Temperature	$T_{STG}$	-55, +150	°C	
Operating Junction Temperature	$T_J$	225	°C	
Maximum Forward Gate Current	$I_{GMAX}$	13	mA	25 °C
Soldering Temperature <sup>1</sup>	$T_S$	245	°C	
Screw Torque	$\tau$	40	in-oz	
Thermal Resistance, Junction to Case	$R_{\theta JC}$	1.22	°C/W	Pulse Width = 100 $\mu$ s, Duty Cycle = 10%, $P_{DISS} = 55$ W
Thermal Resistance, Junction to Case	$R_{\theta JC}$	1.80	°C/W	CW, $P_{DISS} = 55$ W, 85 °C
Case Operating Temperature	$T_C$	-40, +130	°C	Pulse Width = 100 $\mu$ s, Duty Cycle = 10%, $P_{DISS} = 55$ W
Case Operating Temperature	$T_C$	-40, +90	°C	CW, $P_{DISS} = 55$ W

Note:

<sup>1</sup> Refer to the Application Note on soldering at [www.wolfspeed.com/RF/Document-Library](http://www.wolfspeed.com/RF/Document-Library)**Electrical Characteristics** (Frequency = 8.0 GHz - 11.0 GHz unless otherwise stated;  $T_C = 25$  °C)

Characteristics	Symbol	Min.	Typ.	Max.	Units	Conditions
<b>DC Characteristics<sup>1</sup></b>						
Gate Threshold	$V_{GS(TH)}$	-3.8	-3.0	-2.3	V	$V_{DS} = 10$ V, $I_D = 13$ mA
Gate Quiescent Voltage	$V_{GS(Q)}$	-	-2.7	-	V	$V_{DS} = 28$ V, $I_D = 800$ mA
Saturated Drain Current <sup>2</sup>	$I_{DS}$	9.5	13.2	-	A	$V_{DS} = 6.0$ V, $V_{GS} = 2.0$ V
Drain-Source Breakdown Voltage	$V_{BD}$	84	-	-	V	$V_{GS} = -8$ V, $I_D = 13$ mA
<b>RF Characteristics<sup>3</sup></b>						
Small Signal Gain	S21	-	23	-	dB	$V_{DD} = 28$ V, $I_{DQ} = 800$ mA, Frequency = 8-11 GHz
Input Return Loss	S11	-	-3.7	-	dB	$V_{DD} = 28$ V, $I_{DQ} = 800$ mA, Frequency = 8-11 GHz
Output Return Loss	S22	-	-3.6	-	dB	$V_{DD} = 28$ V, $I_{DQ} = 800$ mA, Frequency = 8-11 GHz
Output Mismatch Stress	VSWR	-	-	5:1	$\Psi$	No damage at all phase angles, $V_{DD} = 28$ V, $I_{DQ} = 800$ mA, Pulse Width = 100 $\mu$ s, Duty Cycle = 10%, $P_{OUT} = 30$ W

Notes:

<sup>1</sup> Measured on-wafer prior to packaging.<sup>2</sup> Scaled from PCM data.<sup>3</sup> Measured in the CMPA801B030F-AMP.

**Electrical Characteristics Continued... ( $T_c = 25^\circ\text{C}$ )**

Characteristics	Symbol	Min.	Typ.	Max.	Units	Conditions
<b>RF Characteristics<sup>1,2</sup></b>						
Output Power	$P_{OUT1}$	–	45.4	–	dBm	$V_{DD} = 28\text{ V}$ , $I_{DQ} = 800\text{ mA}$ , Frequency = 8.0 GHz, $P_{IN} = 28\text{ dBm}$
Output Power	$P_{OUT2}$	–	45.8	–	dBm	$V_{DD} = 28\text{ V}$ , $I_{DQ} = 800\text{ mA}$ , Frequency = 8.5 GHz, $P_{IN} = 28\text{ dBm}$
Output Power	$P_{OUT3}$	–	45.9	–	dBm	$V_{DD} = 28\text{ V}$ , $I_{DQ} = 800\text{ mA}$ , Frequency = 9.0 GHz, $P_{IN} = 28\text{ dBm}$
Output Power	$P_{OUT4}$	–	45.9	–	dBm	$V_{DD} = 28\text{ V}$ , $I_{DQ} = 800\text{ mA}$ , Frequency = 10.0 GHz, $P_{IN} = 28\text{ dBm}$
Output Power	$P_{OUT5}$	–	45.3	–	dBm	$V_{DD} = 28\text{ V}$ , $I_{DQ} = 800\text{ mA}$ , Frequency = 11.0 GHz, $P_{IN} = 28\text{ dBm}$
Power Gain	$G_1$	–	16.5	–	dB	$V_{DD} = 28\text{ V}$ , $I_{DQ} = 800\text{ mA}$ , Frequency = 8.0 GHz, $P_{IN} = 28\text{ dBm}$
Power Gain	$G_2$	–	17.1	–	dB	$V_{DD} = 28\text{ V}$ , $I_{DQ} = 800\text{ mA}$ , Frequency = 8.5 GHz, $P_{IN} = 28\text{ dBm}$
Power Gain	$G_3$	–	16.4	–	dB	$V_{DD} = 28\text{ V}$ , $I_{DQ} = 800\text{ mA}$ , Frequency = 9.0 GHz, $P_{IN} = 28\text{ dBm}$
Power Gain	$G_4$	–	15.8	–	dB	$V_{DD} = 28\text{ V}$ , $I_{DQ} = 800\text{ mA}$ , Frequency = 10.0 GHz, $P_{IN} = 28\text{ dBm}$
Power Gain	$G_5$	–	16.9	–	dB	$V_{DD} = 28\text{ V}$ , $I_{DQ} = 800\text{ mA}$ , Frequency = 11.0 GHz, $P_{IN} = 28\text{ dBm}$
Power Added Efficiency	$PAE_1$	–	40.5	–	%	$V_{DD} = 28\text{ V}$ , $I_{DQ} = 800\text{ mA}$ , Frequency = 8.0 GHz, $P_{IN} = 28\text{ dBm}$
Power Added Efficiency	$PAE_2$	–	45.3	–	%	$V_{DD} = 28\text{ V}$ , $I_{DQ} = 800\text{ mA}$ , Frequency = 8.5 GHz, $P_{IN} = 28\text{ dBm}$
Power Added Efficiency	$PAE_3$	–	41.7	–	%	$V_{DD} = 28\text{ V}$ , $I_{DQ} = 800\text{ mA}$ , Frequency = 9.0 GHz, $P_{IN} = 28\text{ dBm}$
Power Added Efficiency	$PAE_4$	–	36.0	–	%	$V_{DD} = 28\text{ V}$ , $I_{DQ} = 800\text{ mA}$ , Frequency = 10.0 GHz, $P_{IN} = 28\text{ dBm}$
Power Added Efficiency	$PAE_5$	–	39.8	–	%	$V_{DD} = 28\text{ V}$ , $I_{DQ} = 800\text{ mA}$ , Frequency = 11.0 GHz, $P_{IN} = 28\text{ dBm}$
Pulse Amplitude Droop	D	–	0.1	–	dB	$V_{DD} = 28\text{ V}$ , $I_{DQ} = 800\text{ mA}$ , Frequency = 8.5 - 11.0 GHz, $P_{IN} = 28\text{ dBm}$

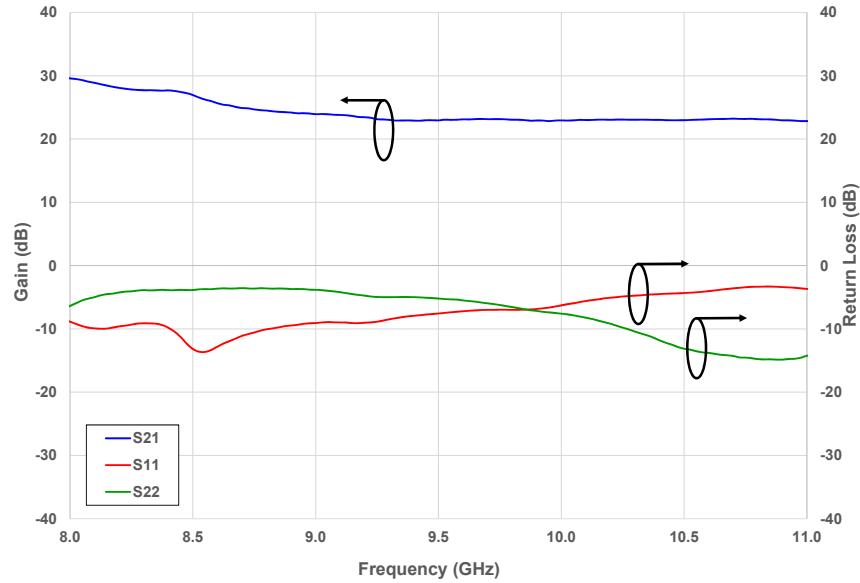
Notes:

<sup>1</sup> Pulse Width = 100  $\mu\text{s}$ , Duty Cycle = 10 %.<sup>2</sup> Measured in CMPA801B030F-AMP.**Electrostatic Discharge (ESD) Classifications**

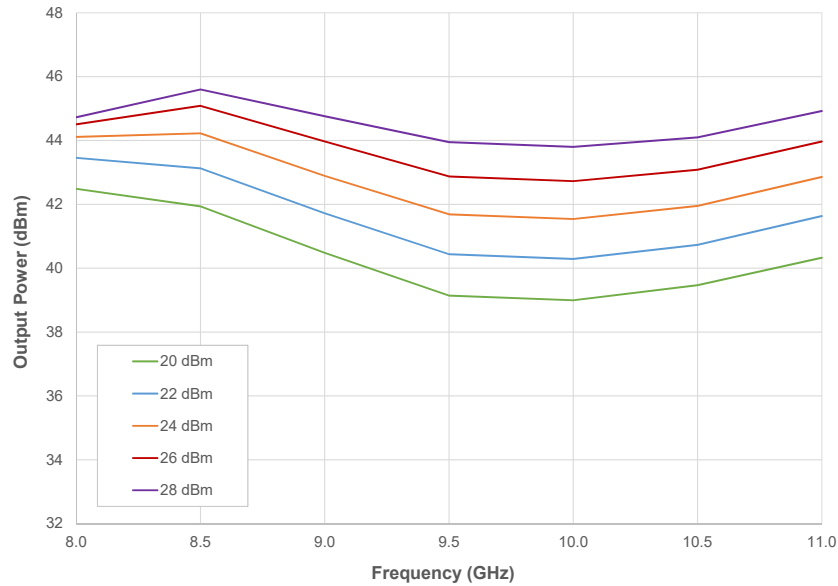
Parameter	Symbol	Class	Test Methodology
Human Body Model	HBM	1A (> 250 V)	JEDEC JESD22 A114-D
Charge Device Model	CDM	II (200 V < 500 V)	JEDEC JESD22 C101-C

Typical Performance

**Figure 1. - Small Signal Gain and Return Loss vs. Frequency of the CMPA801B030F as Measured in Circuit CMPA801B030F-AMP Demonstration Amplifier**  
 $V_{DD} = 28\text{ V}, I_{DQ} = 800\text{ mA}$

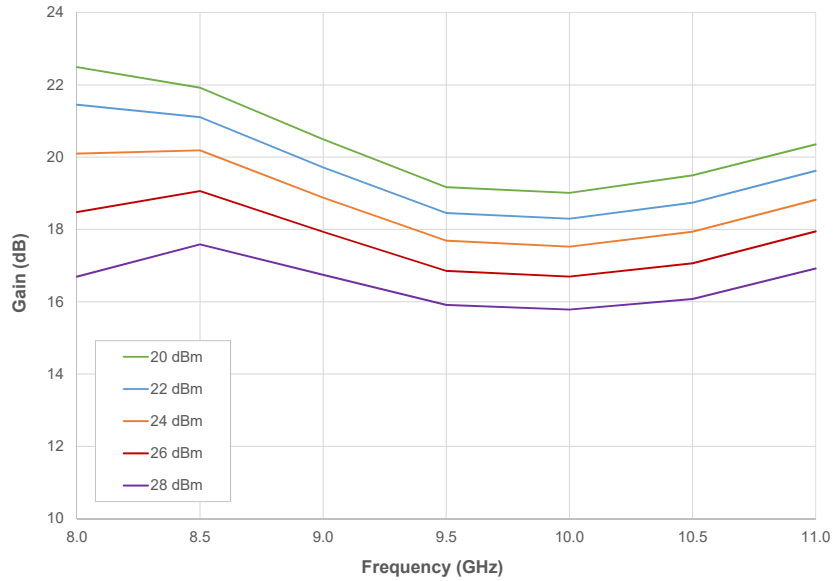


**Figure 2. - CW Output Power vs Frequency as a Function of Input Power of the CMPA801B030F as Measured in Demonstration Amplifier Circuit CMPA801B030F-AMP**  
 $V_{DD} = 28\text{ V}, I_{DQ} = 800\text{ mA}$

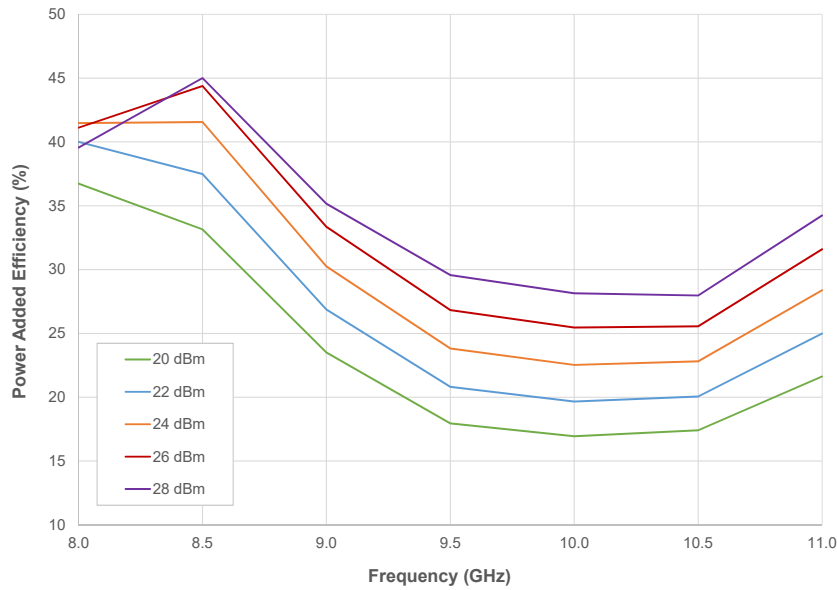


Typical Performance

**Figure 3. - CW Gain vs Frequency as a Function of Input Power of the CMPA801B030F as Measured in Demonstration Amplifier Circuit CMPA801B030F-AMP**  
 $V_{DD} = 28\text{ V}, I_{DQ} = 800\text{ mA}$



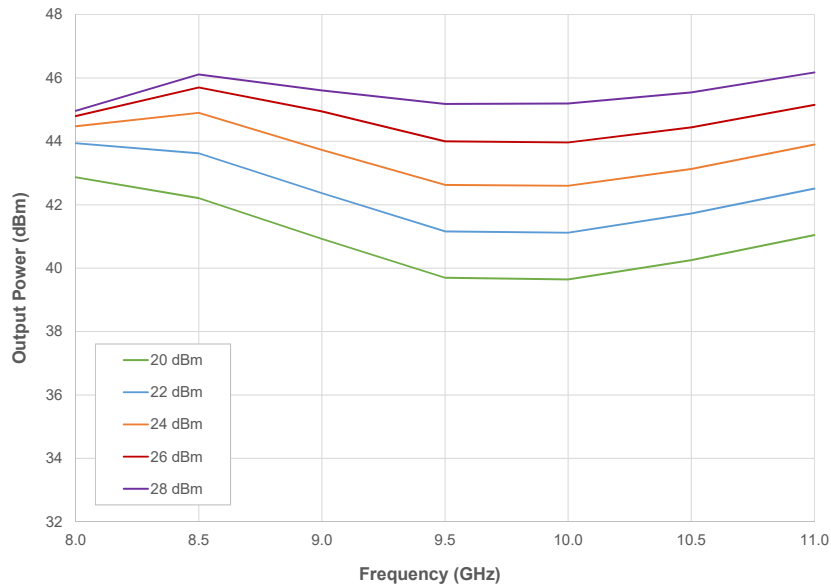
**Figure 4. - CW Power Added Efficiency vs Frequency as a Function of Input Power of the CMPA801B030F as Measured in Demonstration Amplifier Circuit CMPA801B030F-AMP**  
 $V_{DD} = 28\text{ V}, I_{DQ} = 800\text{ mA}$



Typical Performance

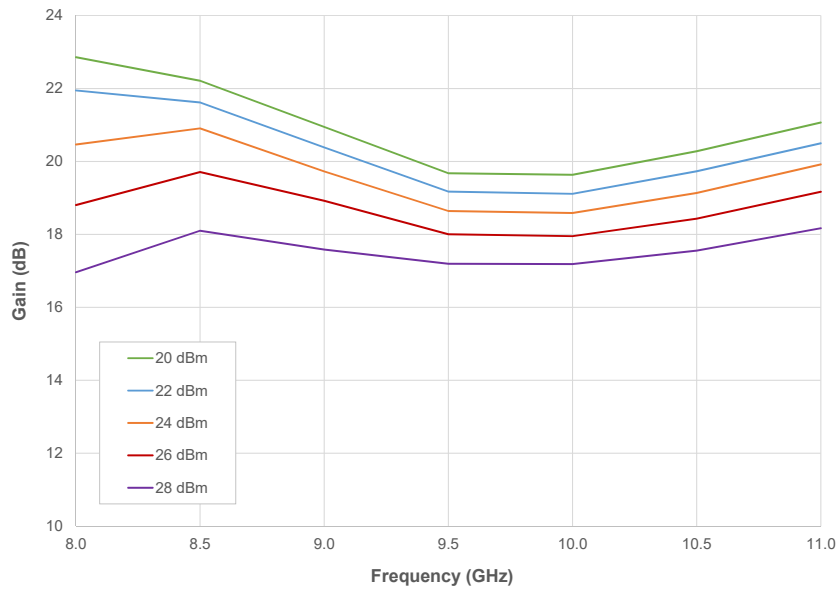
**Figure 5. - Pulsed Output Power vs Frequency as a Function of Input Power of the CMPA801B030F as Measured in Demonstration Amplifier Circuit CMPA801B030F-AMP**

$V_{DD} = 28\text{ V}$ ,  $I_{DQ} = 800\text{ mA}$ , Pulse Width = 100  $\mu\text{s}$ , Duty Cycle = 10%



**Figure 6. - Pulsed Gain vs Frequency as a Function of Input Power of the CMPA801B030F as Measured in Demonstration Amplifier Circuit CMPA801B030F-AMP**

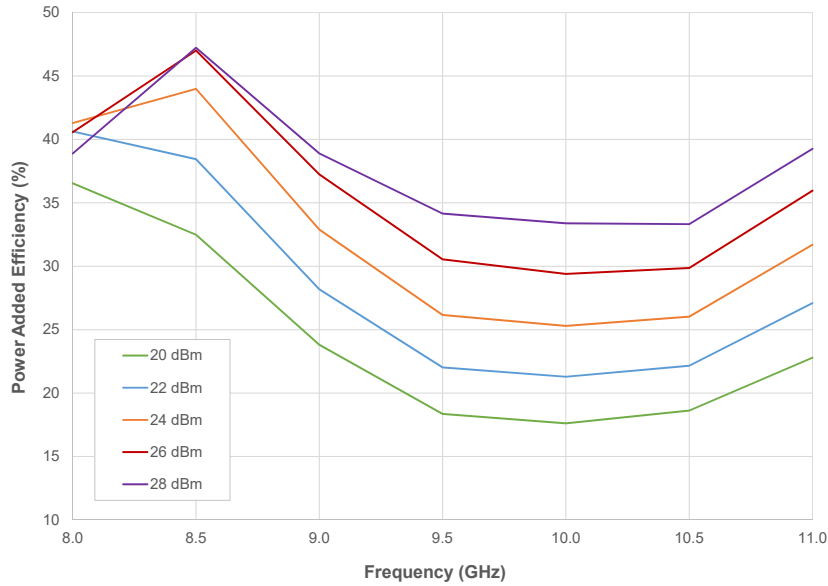
$V_{DD} = 28\text{ V}$ ,  $I_{DQ} = 800\text{ mA}$ , Pulse Width = 100  $\mu\text{s}$ , Duty Cycle = 10%



Typical Performance

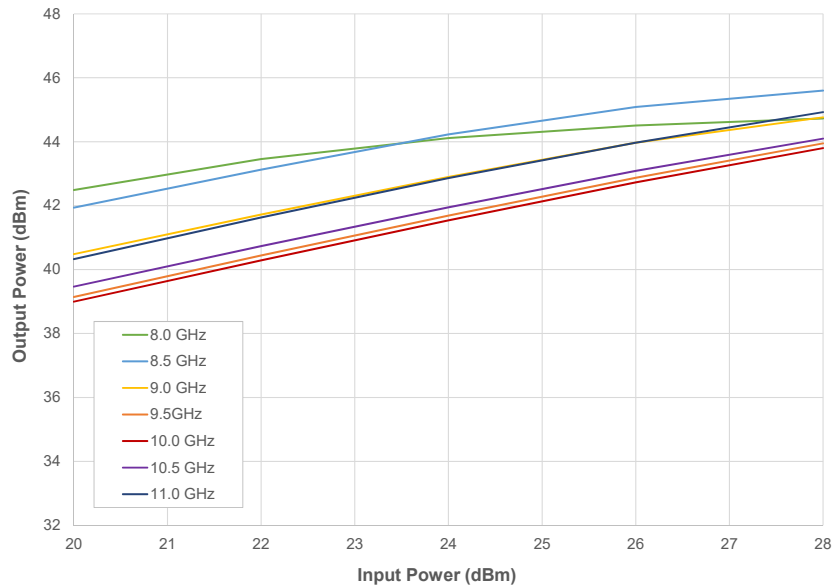
**Figure 7. - Pulsed Power Added Efficiency vs Frequency as a Function of Input Power of the CPMA801B030F as Measured in Demonstration Amplifier Circuit CPMA801B030F-AMP**

$V_{DD} = 28\text{ V}$ ,  $I_{DQ} = 800\text{ mA}$ , Pulse Width = 100  $\mu\text{s}$ , Duty Cycle = 10%



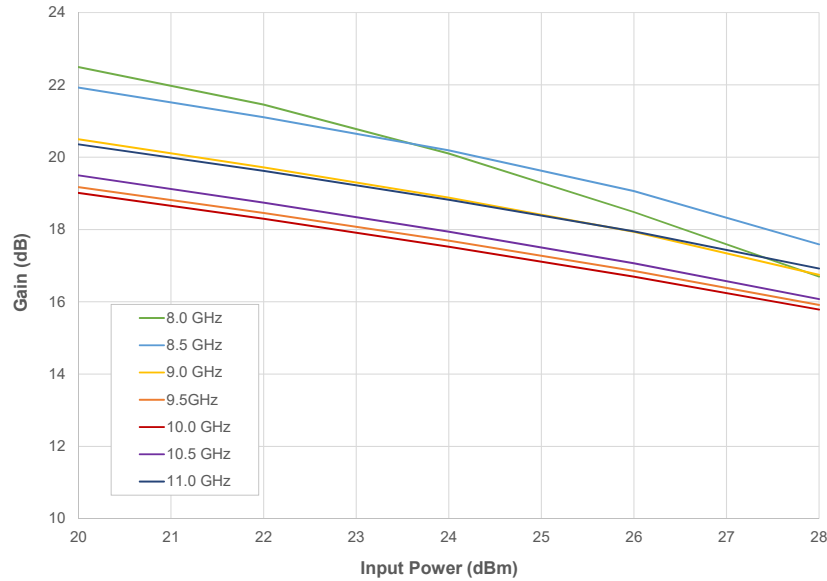
**Figure 8. - CW Output Power vs Input Power as a Function of Frequency of the CPMA801B030F as Measured in Demonstration Amplifier Circuit CPMA801B030F-AMP**

$V_{DD} = 28\text{ V}$ ,  $I_{DQ} = 800\text{ mA}$

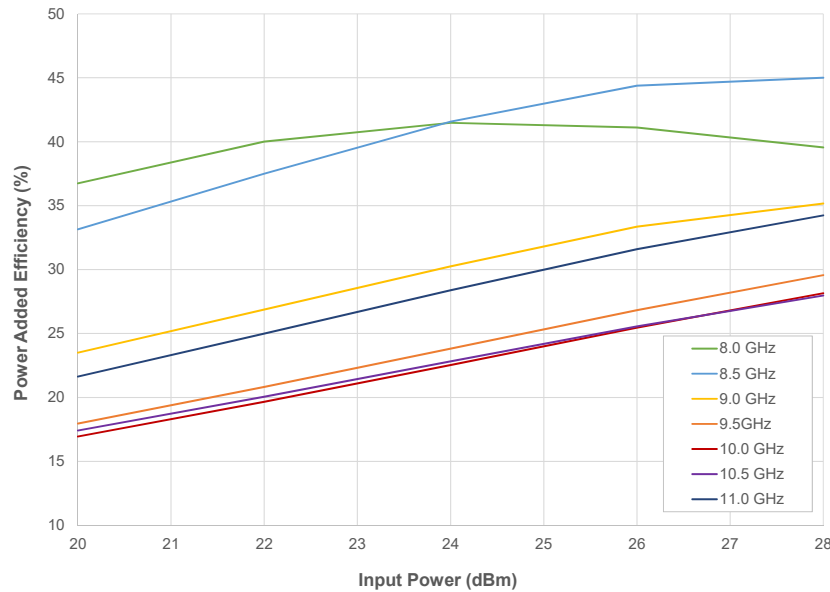


Typical Performance

**Figure 9. - CW Gain vs Input Power as a Function of Frequency of the CMPA801B030F as Measured in Demonstration Amplifier Circuit CMPA801B030F-AMP**  
 $V_{DD} = 28\text{ V}, I_{DQ} = 800\text{ mA}$



**Figure 10. - CW Power Added Efficiency vs Input Power as a Function of Frequency of the CMPA801B030F as Measured in Demonstration Amplifier Circuit CMPA801B030F-AMP**  
 $V_{DD} = 28\text{ V}, I_{DQ} = 800\text{ mA}$

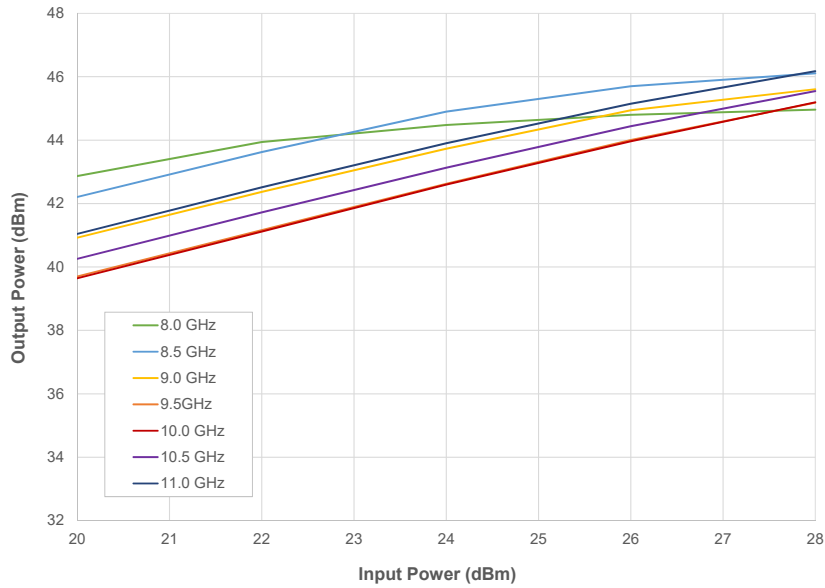




Typical Performance

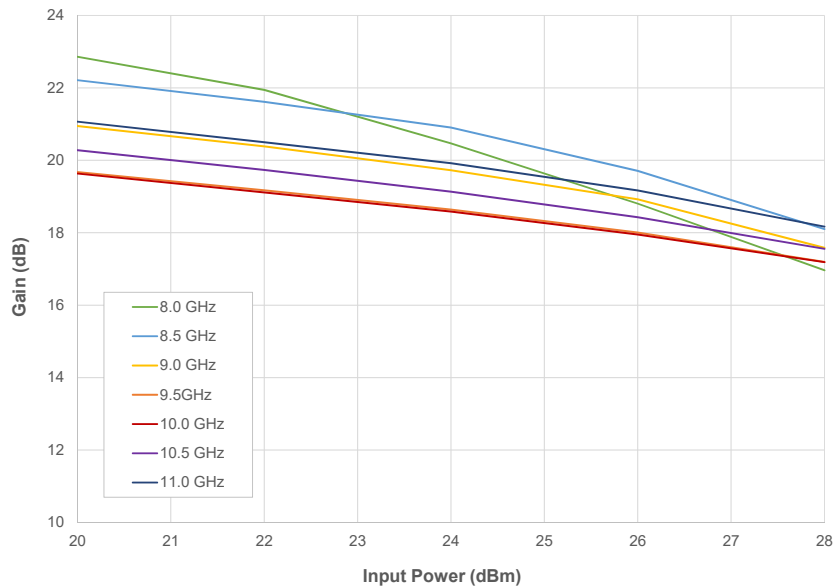
**Figure 11. - Pulsed Output Power vs Input Power as a Function of Frequency of the CMPA801B030F as Measured in Demonstration Amplifier Circuit CMPA801B030F-AMP**

$V_{DD} = 28\text{ V}$ ,  $I_{DQ} = 800\text{ mA}$ , Pulse Width = 100  $\mu\text{s}$ , Duty Cycle = 10%



**Figure 12. - Pulsed Gain vs Input Power as a Function of Frequency of the CMPA801B030F as Measured in Demonstration Amplifier Circuit CMPA801B030F-AMP**

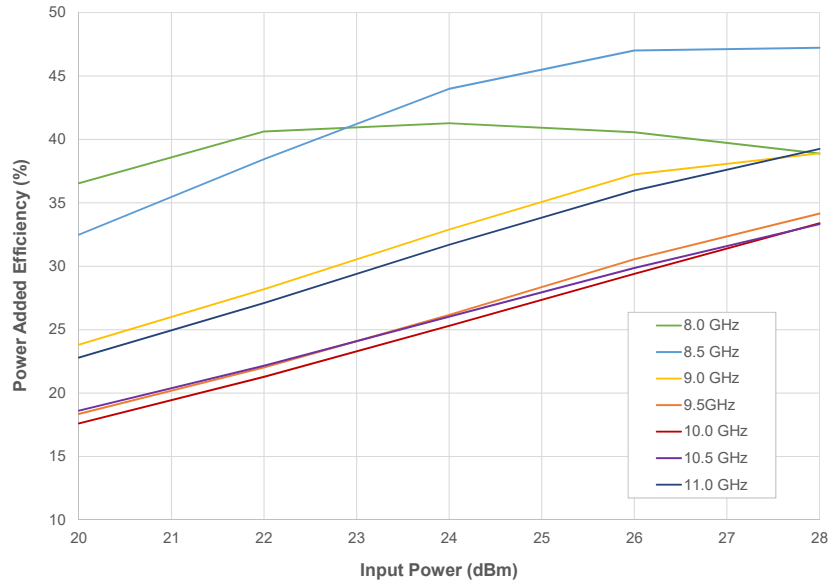
$V_{DD} = 28\text{ V}$ ,  $I_{DQ} = 800\text{ mA}$ , Pulse Width = 100  $\mu\text{s}$ , Duty Cycle = 10%



Typical Performance

**Figure 13. - Pulsed Power Added Efficiency vs Input Power as a Function of Frequency of the CMPA801B030F as Measured in Demonstration Amplifier Circuit CMPA801B030F-AMP**

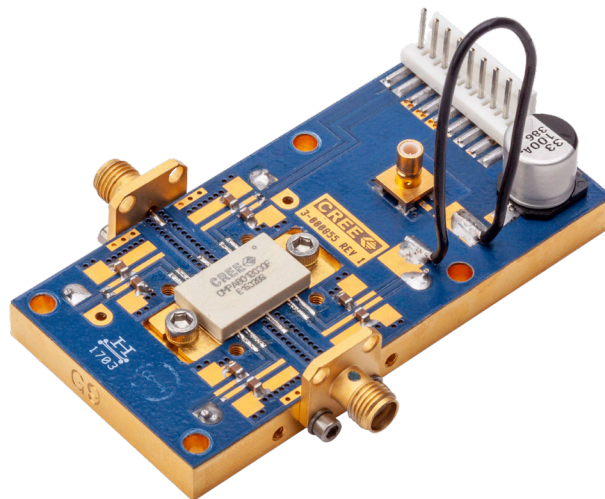
$V_{DD} = 28\text{ V}$ ,  $I_{DQ} = 800\text{ mA}$ , Pulse Width = 100  $\mu\text{s}$ , Duty Cycle = 10%



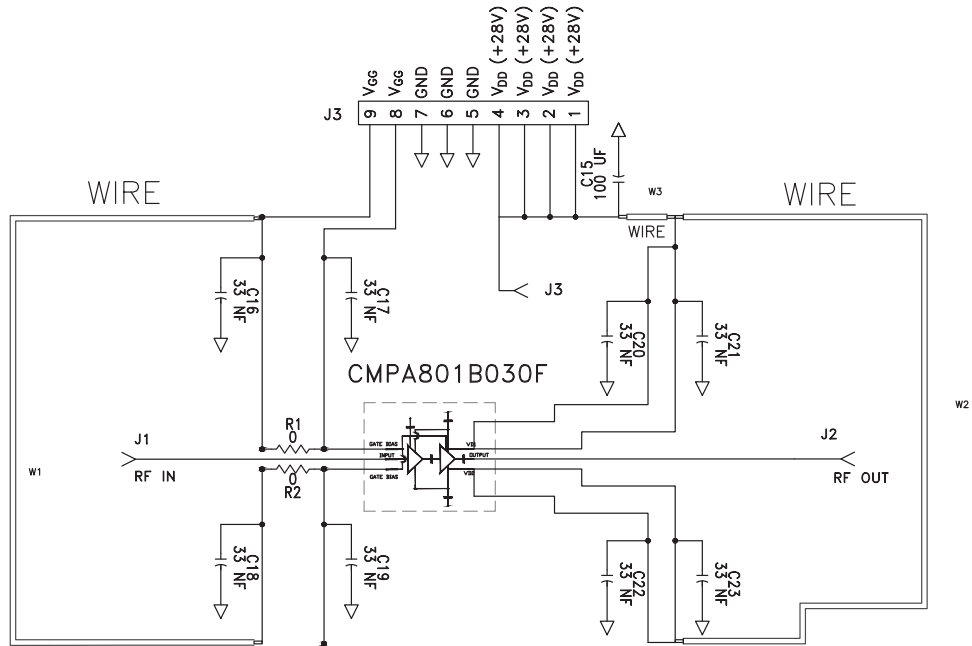
## CMPA801B030F-AMP Demonstration Amplifier Circuit Bill of Materials

Designator	Description	Qty
C15	CAP ELECT 100UF 80V AFK SMD	1
C16-C23	CAP,33000PF, 0805,100V, X7R	8
R1, R2	RES 0.0 OHM 1/16W 0402 SMD	2
J1, J2	CONN, SMA, PANEL MOUNT JACK, FLANGE, 4-HOLE, BLUNT POST, 20MIL	2
J4	CONN, SMB, STRAIGHT JACK RECEPTACLE, SMT, 50 OHM, Au PLATED	1
J3	HEADER RT>PLZ .1CEN LK 9POS	1
W1	WIRE, BLACK, 22 AWG ~ 1.50"	1
W2	WIRE, BLACK, 22 AWG ~ 1.75"	1
W3	WIRE, BLACK, 22 AWG ~ 3.0"	1
-	PCB, TEST FIXTURE, TACONICS RF35P, 20 MILS, 440208 PKG	1
-	2-56 SOC HD SCREW 3/16 SS	4
-	#2 SPLIT LOCKWASHER SS	4
Q1	Transistor CMPA801B030F	1

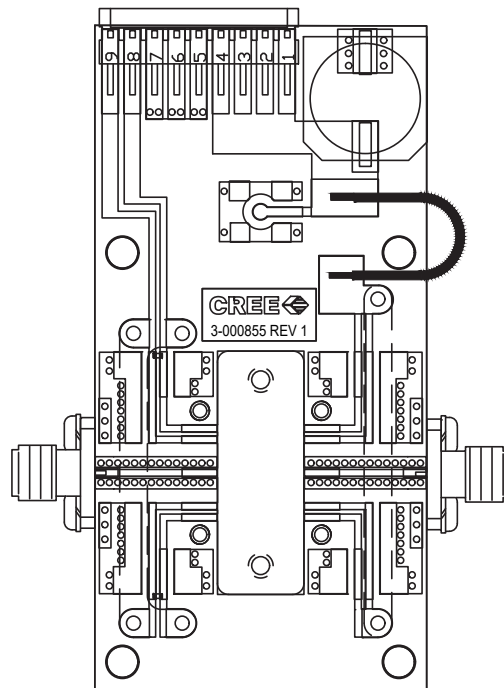
## CMPA801B030F-AMP Demonstration Amplifier Circuit



**CMPA801B030F-AMP Demonstration Amplifier Circuit Outline**

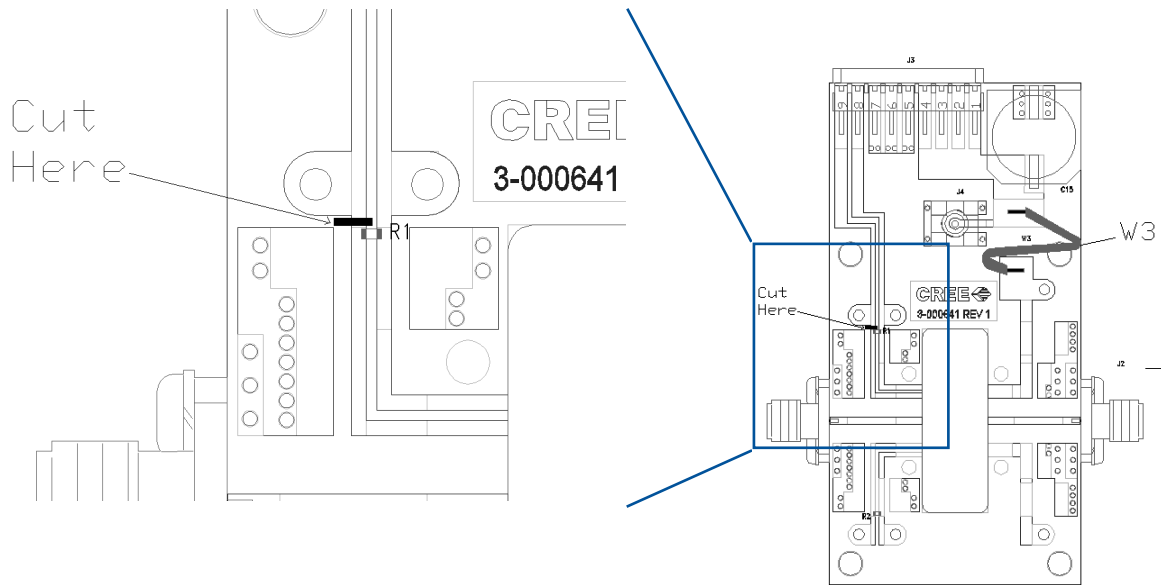


**CMPA801B030F-AMP Demonstration Amplifier Circuit Outline**

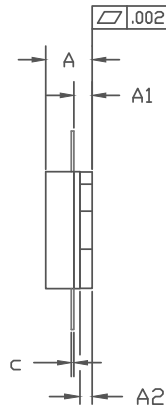
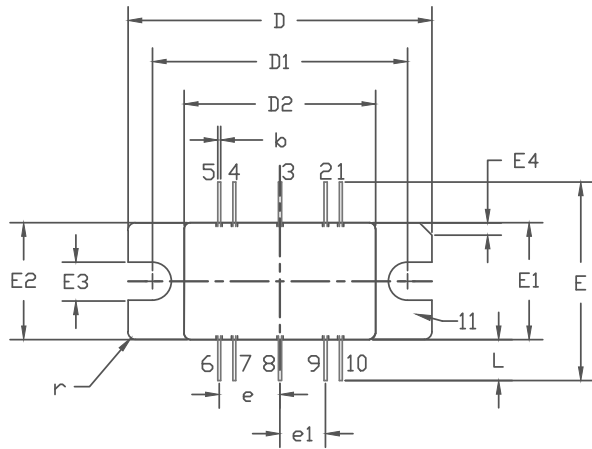


### CMPA801B030F-AMP Demonstration Amplifier Circuit Schematic

To configure the CMPA801B030F test fixture to enable independent  $V_{G1}$  /  $V_{G2}$  control of the device, a cut must be made to the microstrip line just above the R1 resistor as shown. Pin 9 will then supply  $V_{G1}$  and Pin 8 will supply  $V_{G2}$ .



**Product Dimensions CPM801B030F (Package Type – 440213)**



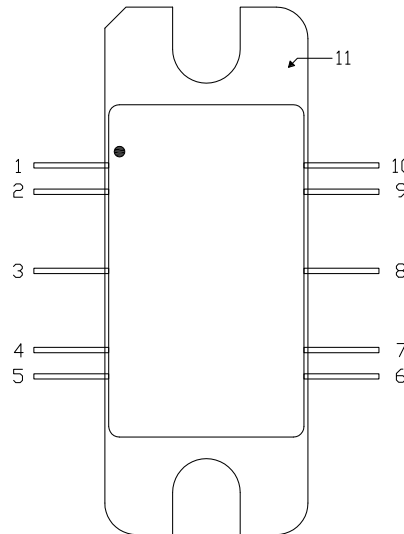
PIN 1: GATE BIAS 6: DRAIN BIAS  
 2: GATE BIAS 7: DRAIN BIAS  
 3: RF IN 8: RF OUT  
 4: GATE BIAS 9: DRAIN BIAS  
 5: GATE BIAS 10: DRAIN BIAS  
 11: SOURCE

NOTES:

1. DIMENSIONING AND TOLERANCING PER ANSI Y14.5M - 1994.
2. CONTROLLING DIMENSION: INCH.
3. ADHESIVE FROM LID MAY EXTEND A MAXIMUM OF 0.020" BEYOND EDGE OF LID.
4. LID MAY BE MISALIGNED TO THE BODY OF PACKAGE BY A MAXIMUM OF 0.008" IN ANY DIRECTION.

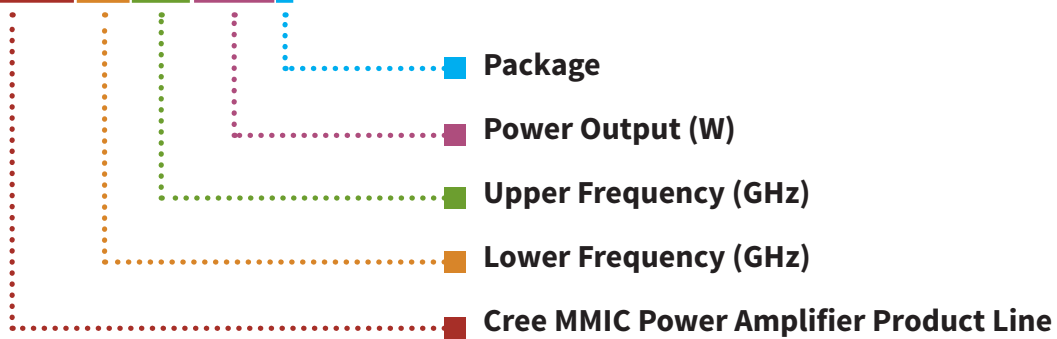
DIM	INCHES		MILLIMETERS		NOTES
	MIN	MAX	MIN	MAX	
A	0.148	0.168	3.76	4.27	
A1	0.055	0.065	1.40	1.65	
A2	0.035	0.045	0.89	1.14	
b	0.01 TYP		0.254 TYP		10x
c	0.007	0.009	0.18	0.23	
D	0.995	1.005	25.27	25.53	
D1	0.835	0.845	21.21	21.46	
D2	0.623	0.637	15.82	16.18	
E	0.653 TYP		16.59 TYP		
E1	0.380	0.390	9.65	9.91	
E2	0.380	0.390	9.65	9.91	
E3	0.120	0.130	3.05	3.30	
E4	0.035	0.045	0.89	1.14	45° CHAMFER
e	0.200 TYP		5.08 TYP		4x
e1	0.150 TYP		3.81 TYP		4x
L	0.115	0.155	2.92	3.94	10x
r	0.025 TYP		.635 TYP		3x

Pin Number	Qty
1	Gate Bias for Stage 2
2	Gate Bias for Stage 2
3	RF In
4	Gate Bias for Stage 1
5	Gate Bias for Stage 1
6	Drain Bias
7	Drain Bias
8	RF Out
9	Drain Bias
10	Drain Bias
11	Source



**Part Number System**

**CMPA801B030F**



Parameter	Value	Units
Lower Frequency	8.0	GHz
Upper Frequency <sup>1</sup>	11.0	GHz
Power Output	30	W
Package	Flange	-

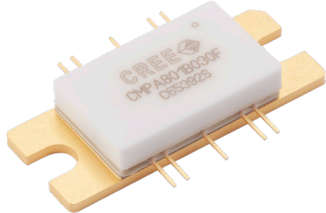
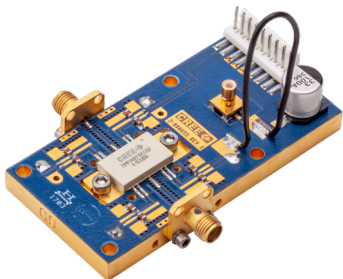
**Table 1.**

**Note<sup>1</sup>:** Alpha characters used in frequency code indicate a value greater than 9.9 GHz. See Table 2 for value.

Character Code	Code Value
A	0
B	1
C	2
D	3
E	4
F	5
G	6
H	7
J	8
K	9
Examples:	1A = 10.0 GHz 2H = 27.0 GHz

**Table 2.**

**Product Ordering Information**

Order Number	Description	Unit of Measure	Image
CMPA801B030F	GaN HEMT	Each	
CMPA801B030F-AMP	Test board with GaN HEMT installed	Each	



For more information, please contact:

4600 Silicon Drive  
Durham, North Carolina, USA 27703  
[www.wolfspeed.com/rf](http://www.wolfspeed.com/rf)

Sales Contact  
[rfsales@cree.com](mailto:rfsales@cree.com)

## Notes & Disclaimer

---

Specifications are subject to change without notice. “Typical” parameters are the average values expected by Cree in large quantities and are provided for information purposes only. Cree products are not warranted or authorized for use as critical components in medical, life-saving, or life-sustaining applications, or other applications where a failure would reasonably be expected to cause severe personal injury or death. No responsibility is assumed by Cree for any infringement of patents or other rights of third parties which may result from use of the information contained herein. No license is granted by implication or otherwise under any patent or patent rights of Cree.

© 2019-2020 Cree, Inc. All rights reserved. Wolfspeed® and the Wolfspeed logo are registered trademarks of Cree, Inc.

## X-ON Electronics

Largest Supplier of Electrical and Electronic Components

*Click to view similar products for [RF JFET Transistors](#) category:*

*Click to view products by [Wolfspeed](#) manufacturer:*

Other Similar products are found below :

[XF1001-SC-EV1](#) [CE3514M4](#) [CE3514M4-C2](#) [CE3520K3-C1](#) [CE3521M4](#) [CE3521M4-C2](#) [CE3512K2-C1](#) [NPT25100B](#) [CE3520K3](#)  
[CGH55030F1](#) [CGH27030F](#) [CG2H80030D-GP4](#) [CGH27060F](#) [CGH25120F](#) [CMPA801B030F](#) [TGF2023-2-01](#) [TGF2023-2-02](#) [CGH40006P](#)  
[BF861B,235](#) [QPD1009](#) [MAGX-011086](#) [QPD1014SR](#) [T2G6000528-Q3](#) [CG2H40025F](#) [CGHV40200PP](#) [CGHV40050F](#) [CGHV14800F](#)  
[CGH27030P](#) [CGH09120F](#) [CG2H80015D-GP4](#) [CG2H40010F](#) [CG2H40045F](#) [T2G4003532-FL](#) [TGF2942](#) [T2G6003028-FS](#) [T2G6000528-Q3](#)  
[28V](#) [T2G4003532-FS](#) [T1G2028536-FL](#) [QPD1015](#) [QPD1010](#) [QPD1008L](#) [QPD1008](#) [QPD1000](#) [JANTXV2N4858](#) [ATF-521P8-BLK](#)  
[J175D26Z](#) [AGX-1/2](#) [CE3512K2](#) [2N3819](#) [CGH55030F2](#)