

V_{DS}	1200 V
I_{DS}	400 A

WAB400M12BM3

1200 V, 400 A All-Silicon Carbide

THB-80 Qualified, Conduction Optimized, Half-Bridge Module

Technical Features

- Industry Standard 62mm Footprint
- High Humidity Operation THB-80 (HV-H3TRB)
- High Junction Temperature (175 °C) Operation
- Implements Conduction Optimized Third Generation SiC MOSFET Technology
- Low Inductance (10.2 nH) Design
- Silicon Nitride Insulator and Copper Baseplate

Package 105mm x 61.5 mm x 31.4 mm

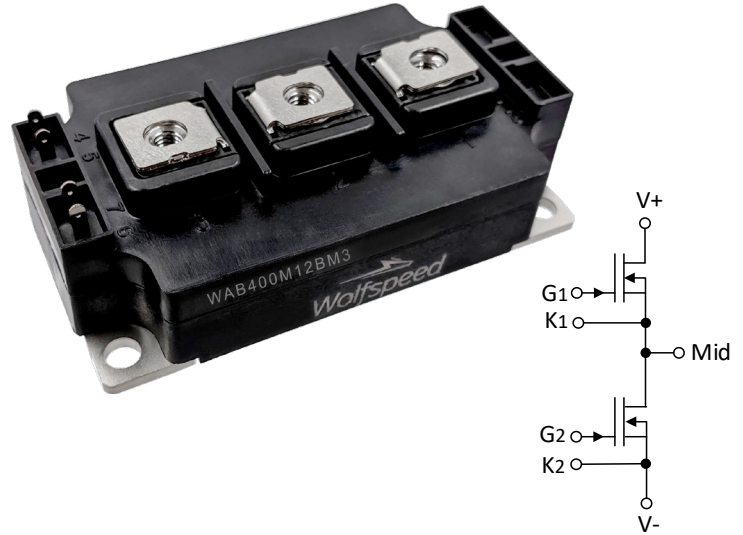

Applications

- Railway & Traction
- Solar
- EV Chargers
- Industrial Automation & Testing

System Benefits

- Fast Time-to-Market with Minimal Development Required for Transition from 62mm Si IGBT Packages
- Increased System Efficiency due to Low Switching & Conduction Losses of SiC
- High Reliability Material Selection

Key Parameters ($T_c = 25^\circ\text{C}$ unless otherwise specified)

Symbol	Parameter	Min.	Typ.	Max.	Unit	Test Conditions	Note
$V_{DS\max}$	Drain-Source Voltage			1200	V		
$V_{GS\max}$	Gate-Source Voltage, Maximum Value	-8		+19		Transient, <100 ns	Fig. 32
$V_{GS\text{op}}$	Gate-Source Voltage, Recommended Operating Value	-4		+15		Static	
I_{DS}	DC Continuous Drain Current		468		A	$V_{GS} = 15\text{ V}, T_c = 25^\circ\text{C}, T_{vj} \leq 175^\circ\text{C}$	Fig. 20
			353			$V_{GS} = 15\text{ V}, T_c = 90^\circ\text{C}, T_{vj} \leq 175^\circ\text{C}$	Note 1
I_{SD}	DC Source-Drain Current		468			$V_{GS} = 15\text{ V}, T_c = 25^\circ\text{C}, T_{vj} \leq 175^\circ\text{C}$	
$I_{SD\text{BD}}$	DC Source-Drain Current (Body Diode)		262			$V_{GS} = -4\text{ V}, T_c = 25^\circ\text{C}, T_{vj} \leq 175^\circ\text{C}$	
$I_{DS(\text{pulsed})}$	Maximum Pulsed Drain-Source Current			800		$t_{p\text{max}}$ limited by $T_{j\text{max}}$	
$I_{SD(\text{pulsed})}$	Maximum Pulsed Source-Drain Current			800	$V_{GS} = 15\text{ V}, T_c = 25^\circ\text{C}$		
$T_{vj\text{op}}$	Maximum Virtual Junction Temperature under Switching Conditions	-40		175	$^\circ\text{C}$		

Note 1 Assumes $R_{\text{THJC}} = 0.13^\circ\text{C/W}$ and $R_{\text{DS(on)}} = 5.25\text{ m}\Omega$. Calculate $P_D = (T_{vj} - T_c) / R_{\text{THJC}}$. Calculate $I_{D,\text{MAX}} = \sqrt{(P_D / R_{\text{DS(on)}})}$

MOSFET Characteristics (Per Position) ($T_{vj} = 25^\circ\text{C}$ unless otherwise specified)

Symbol	Parameter	Min.	Typ.	Max.	Unit	Test Conditions	Note
$V_{(BR)DSS}$	Drain-Source Breakdown Voltage	1200			V	$V_{GS} = 0\text{ V}, T_{vj} = -40^\circ\text{C}$	
$V_{GS(th)}$	Gate Threshold Voltage	1.8	2.5	3.6		$V_{DS} = V_{GS}, I_D = 106\text{ mA}$	
			2.0			$V_{DS} = V_{GS}, I_D = 106\text{ mA}, T_{vj} = 175^\circ\text{C}$	
I_{DSS}	Zero Gate Voltage Drain Current		10	200	μA	$V_{GS} = 0\text{ V}, V_{DS} = 1200\text{ V}$	
I_{GSS}	Gate-Source Leakage Current		0.04	1		$V_{GS} = 15\text{ V}, V_{DS} = 0\text{ V}$	
$R_{DS(on)}$	Drain-Source On-State Resistance (Devices Only)		3.25	4.25	m Ω	$V_{GS} = 15\text{ V}, I_D = 400\text{ A}$	Fig. 2
			5.25			$V_{GS} = 15\text{ V}, I_D = 400\text{ A}, T_{vj} = 175^\circ\text{C}$	Fig. 3
g_{fs}	Transconductance		290		S	$V_{DS} = 20\text{ V}, I_{DS} = 400\text{ A}$	Fig. 4
			273			$V_{DS} = 20\text{ V}, I_{DS} = 400\text{ A}, T_{vj} = 175^\circ\text{C}$	
E_{On}	Turn-On Switching Energy, $T_J = 25^\circ\text{C}$ $T_J = 125^\circ\text{C}$ $T_J = 175^\circ\text{C}$		13.2 12.9 14.3		mJ	$V_{DS} = 600\text{ V},$ $I_D = 400\text{ A},$ $V_{GS} = -4\text{ V}/15\text{ V},$ $R_{G(ext)} = 3.0\ \Omega,$ $L = 13.6\ \mu\text{H}$	Fig. 11 Fig. 13
E_{Off}	Turn-Off Switching Energy, $T_J = 25^\circ\text{C}$ $T_J = 125^\circ\text{C}$ $T_J = 175^\circ\text{C}$		11.3 12.0 12.6				
$R_{G(int)}$	Internal Gate Resistance		2.68		Ω	$T_{vj} = 25^\circ\text{C}$	
C_{iss}	Input Capacitance		29.7		nF	$V_{GS} = 0\text{ V}, V_{DS} = 800\text{ V},$ $V_{AC} = 25\text{ mV}, f = 100\text{ kHz}$	Fig. 9
C_{oss}	Output Capacitance		1.18				
C_{rss}	Reverse Transfer Capacitance		62.5				
Q_{GS}	Gate to Source Charge		308		nC	$V_{DS} = 800\text{ V}, V_{GS} = -4\text{ V}/15\text{ V}$ $I_D = 400\text{ A}$ Per IEC60747-8-4 pg 21	
Q_{GD}	Gate to Drain Charge		380				
Q_G	Total Gate Charge		1040				
R_{thJC}	FET Thermal Resistance, Junction to Case		0.13	0.15	$^\circ\text{C}/\text{W}$		Fig. 17

Body Diode Characteristics (Per Position) ($T_{vj} = 25^\circ\text{C}$ unless otherwise specified)

Symbol	Parameter	Min.	Typ.	Max.	Unit	Test Conditions	Note
V_{SD}	Body Diode Forward Voltage		5.4		V	$V_{GS} = -4\text{ V}, I_{SD} = 400\text{ A}$	Fig. 7
			4.9			$V_{GS} = -4\text{ V}, I_{SD} = 400\text{ A}, T_{vj} = 175^\circ\text{C}$	
t_{RR}	Reverse Recovery Time		48.6		ns	$V_{GS} = -4\text{ V}, I_{SD} = 400\text{ A}, V_R = 600\text{ V}$ $di/dt = 10.0\text{ A/ns}, T_J = 175^\circ\text{C}$	
Q_{RR}	Reverse Recovery Charge		7.6				
I_{RRM}	Peak Reverse Recovery Current		265				
E_{RR}	Reverse Recovery Energy $T_J = 25^\circ\text{C}$ $T_J = 125^\circ\text{C}$ $T_J = 175^\circ\text{C}$		0.36 1.33 2.28		mJ	$V_{DS} = 600\text{ V}, I_D = 400\text{ A},$ $V_{GS} = -4\text{ V}/15\text{ V}, R_{G(ext)} = 3.0\ \Omega,$ $L = 13.6\ \mu\text{H}$	Fig. 14



Module Physical Characteristics

Symbol	Parameter	Min.	Typ.	Max.	Unit	Test Conditions
R ₃₋₁	Package Resistance, M1		0.60		mΩ	T _c = 125 °C, Note 2
R ₁₋₂	Package Resistance, M2		0.51			T _c = 125 °C, Note 2
L _{Stray}	Stray Inductance		10.2		nH	Between Terminals 2 and 3
T _c	Case Temperature			125	°C	
W	Weight		300		g	
M _s	Mounting Torque	4.5	5	5.5	N-m	Baseplate, M6 bolts
		4.5	5	5.5		Power Terminals, M6 bolts
V _{isol}	Case Isolation Voltage			5.5	kV	AC, 50 Hz, 1 min
CTI	Comparative Tracking Index		600			
	Clearance Distance	9			mm	Terminal to Terminal
		30				Terminal to Baseplate
	Creepage Distance	30				Terminal to Terminal
		40				Terminal to Baseplate

Note 2 Total Effective Resistance (Per Switch Position) = MOSFET R_{DS(on)} + Switch Position Package Resistance.



Typical Performance

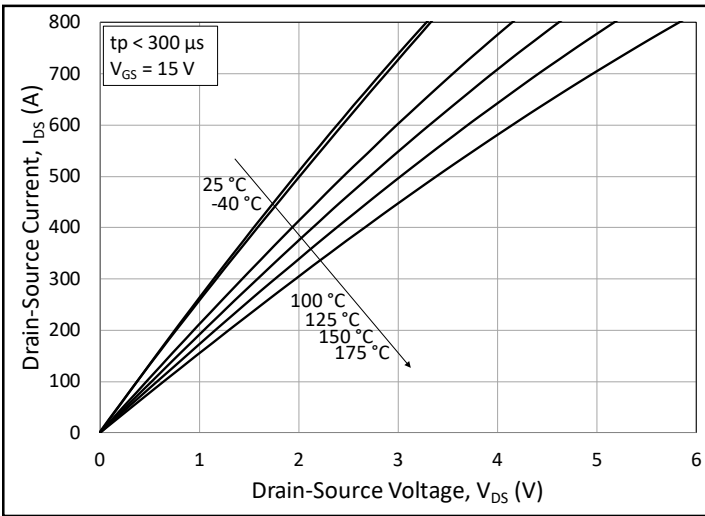

Figure 1. Output Characteristics for Various Junction Temperatures

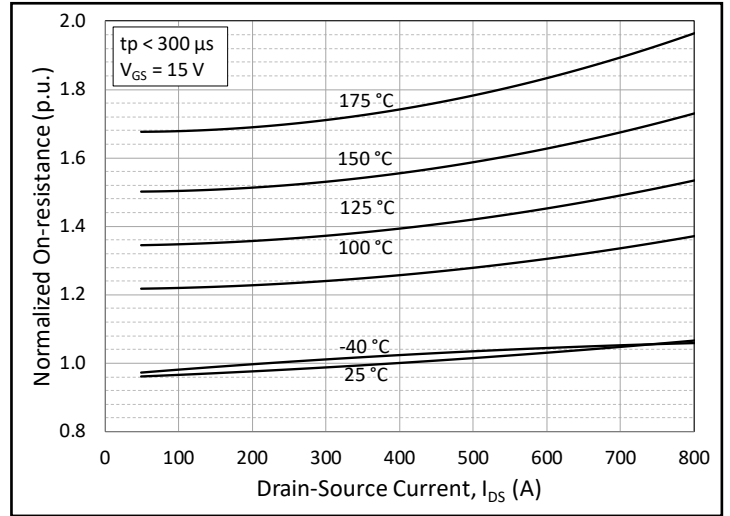

Figure 2. Normalized On-State Resistance vs. Drain Current for Various Junction Temperatures

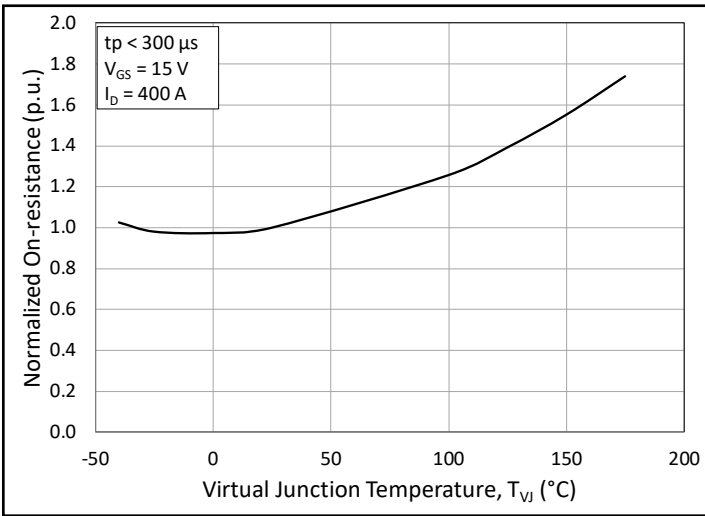

Figure 3. Normalized On-State Resistance vs. Junction Temperature

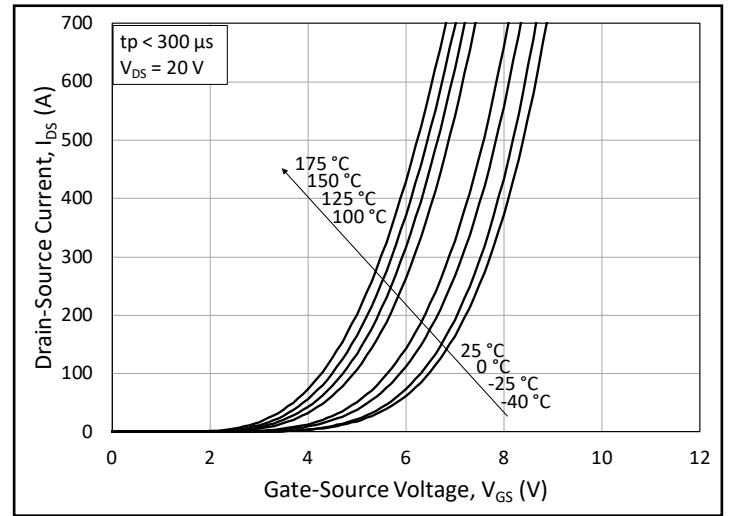

Figure 4. Transfer Characteristic for Various Junction Temperatures

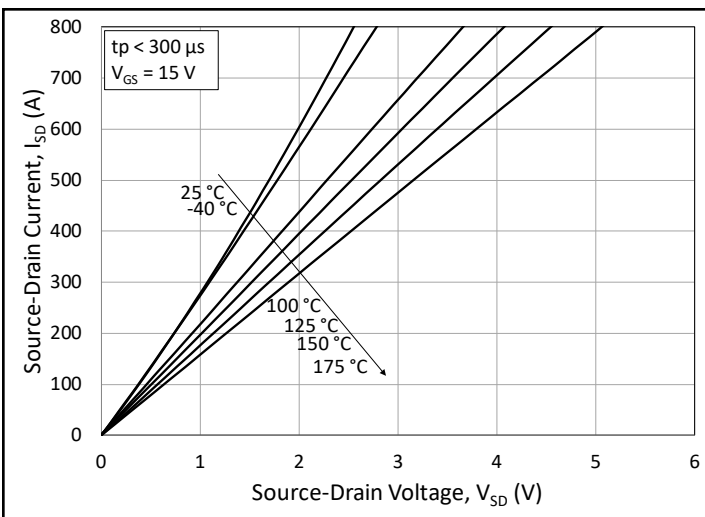

Figure 5. 3rd Quadrant Characteristic vs. Junction Temperatures at $V_{GS} = 15\text{ V}$

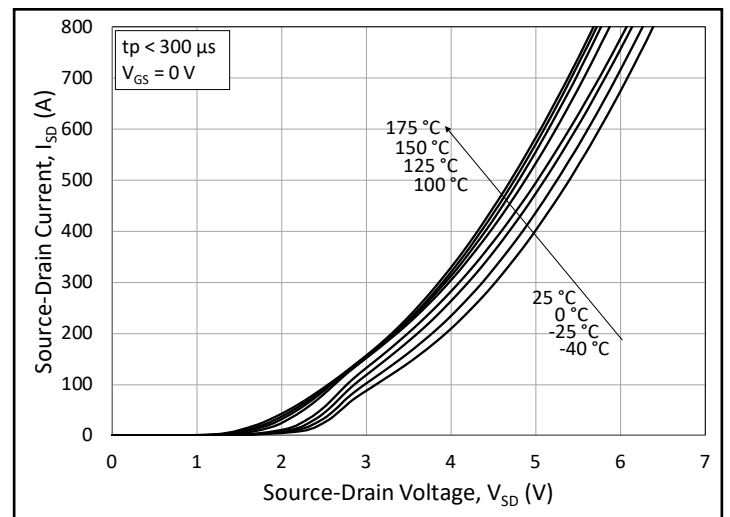

Figure 6. 3rd Quadrant Characteristic vs. Junction Temperatures at $V_{GS} = 0\text{ V}$ (Body Diode)

Typical Performance

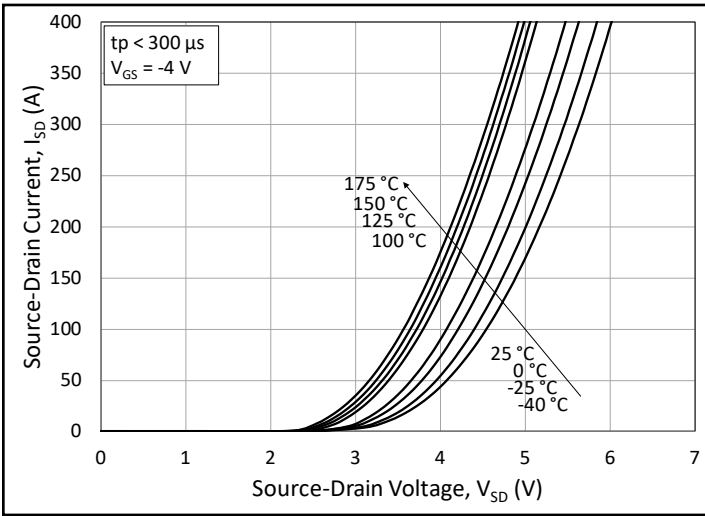

Figure 7. 3rd Quadrant Characteristic vs. Junction Temperatures at $V_{GS} = -4\text{ V}$ (Body Diode)

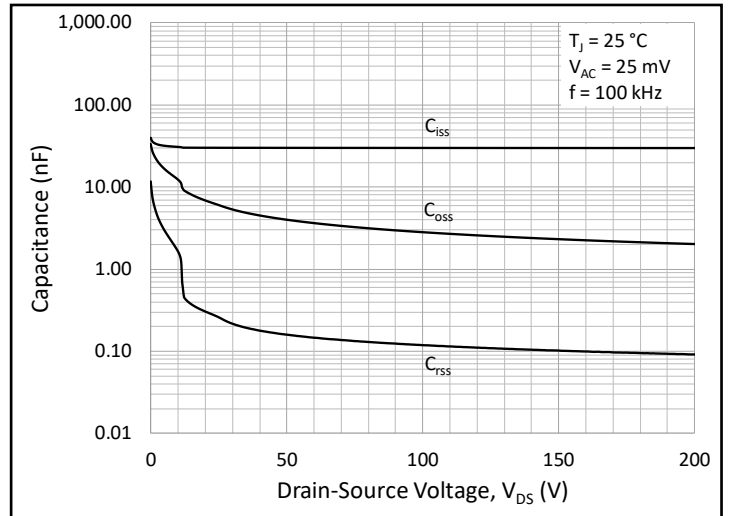

Figure 8. Typical Capacitances vs. Drain to Source Voltage (0 - 200V)

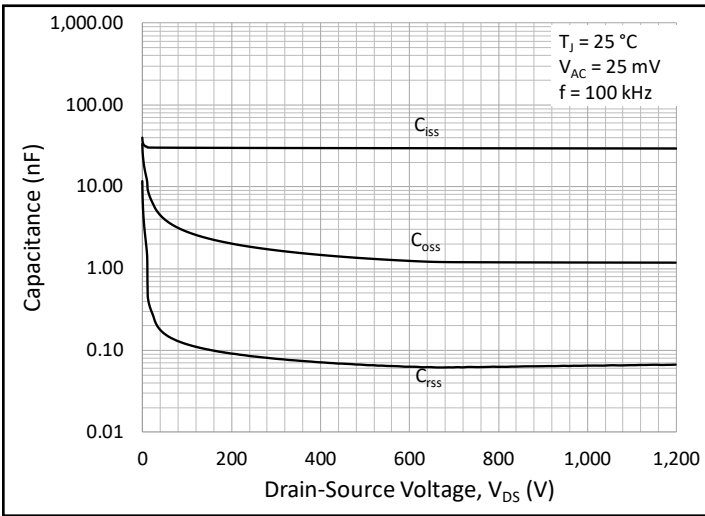

Figure 9. Typical Capacitances vs. Drain to Source Voltage (0 - 1200V)

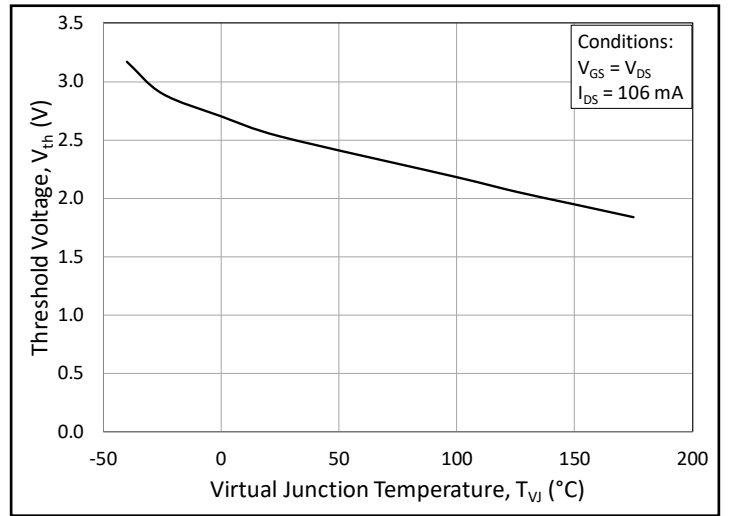

Figure 10. Threshold Voltage vs. Junction Temperature

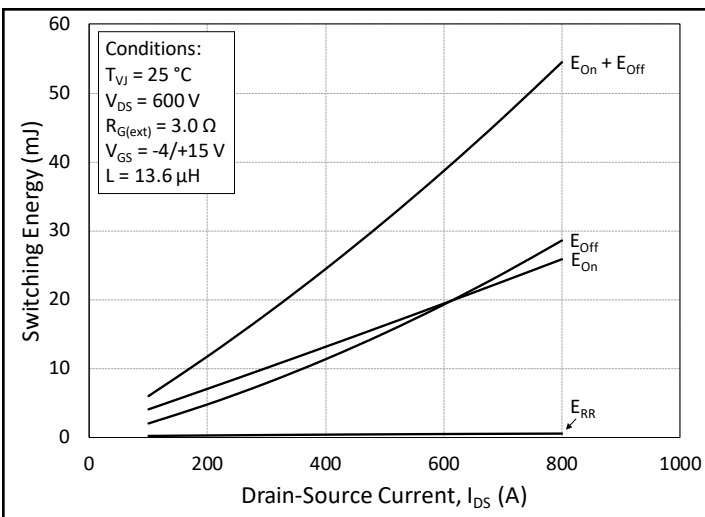

Figure 11. Switching Energy vs. Drain Current ($V_{DS} = 600\text{ V}$)

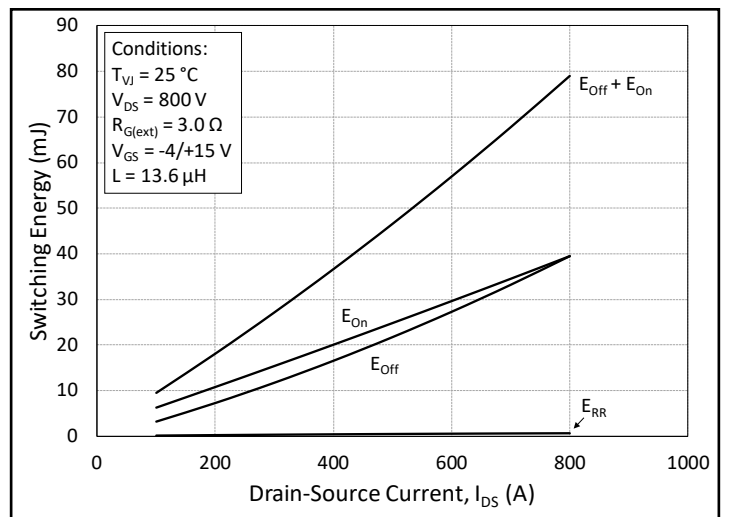

Figure 12. Switching Energy vs. Drain Current ($V_{DS} = 800\text{ V}$)

Typical Performance

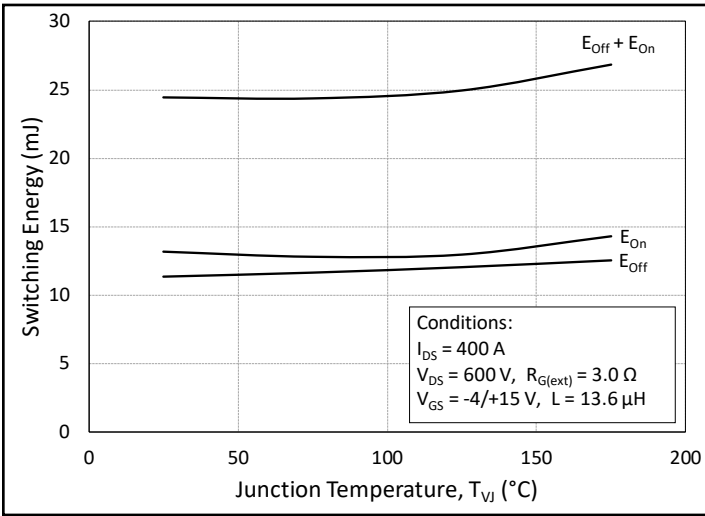

Figure 13. MOSFET Switching Energy vs. Junction Temperature

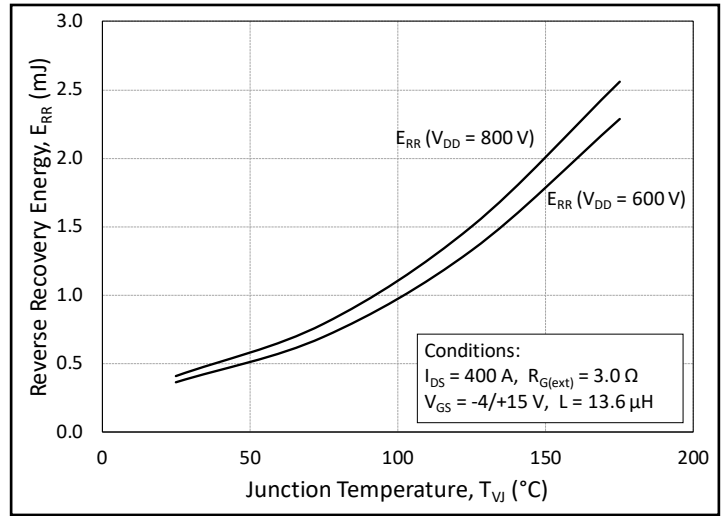

Figure 14. Reverse Recovery Energy vs. Junction Temperature

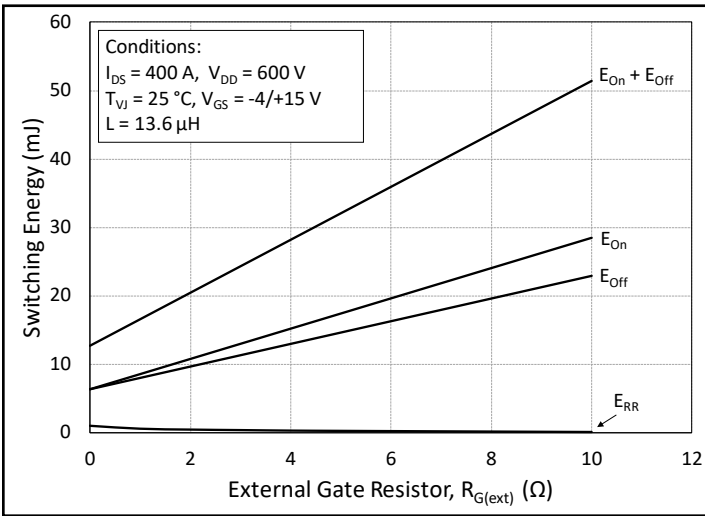

Figure 15. MOSFET Switching Energy vs. External Gate Resistance

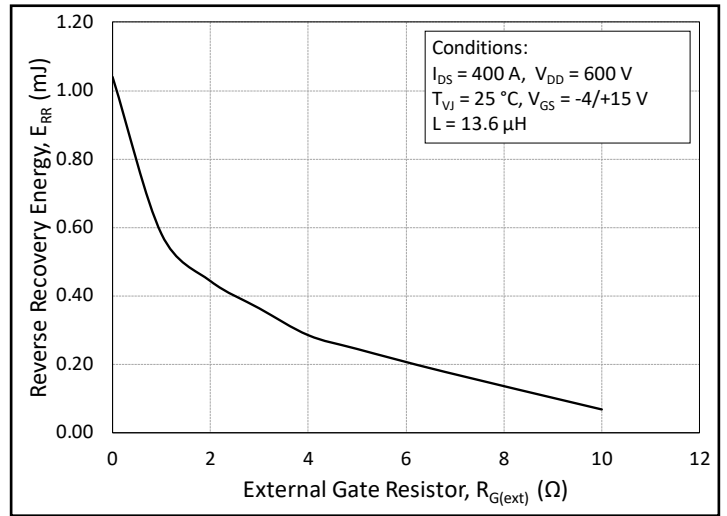

Figure 16. Reverse Recovery Energy vs. External Gate Resistance

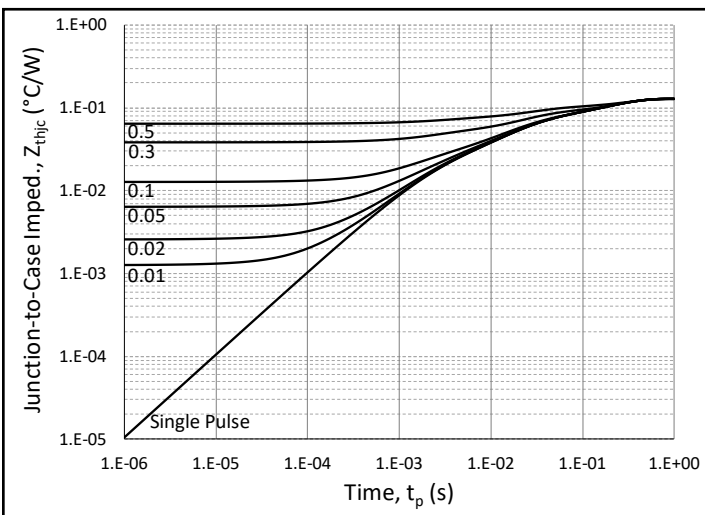

Figure 17. MOSFET Junction to Case Transient Thermal Impedance, $Z_{th(jc)}$ (°C/W)

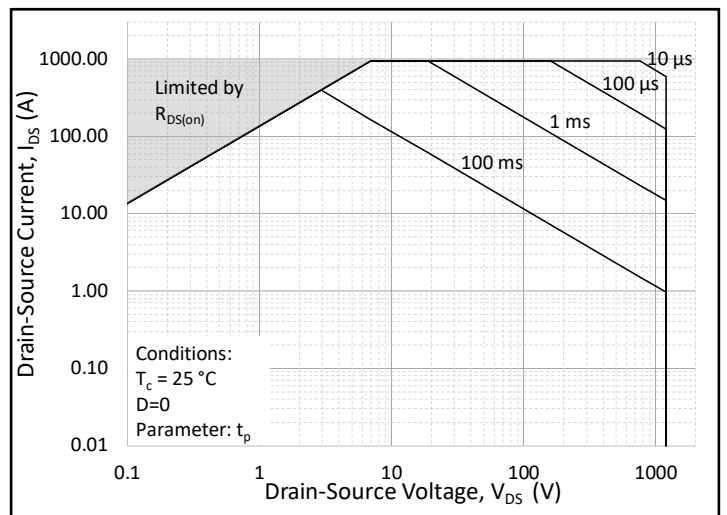

Figure 18. Forward Bias Safe Operating Area (FBSOA)

Typical Performance

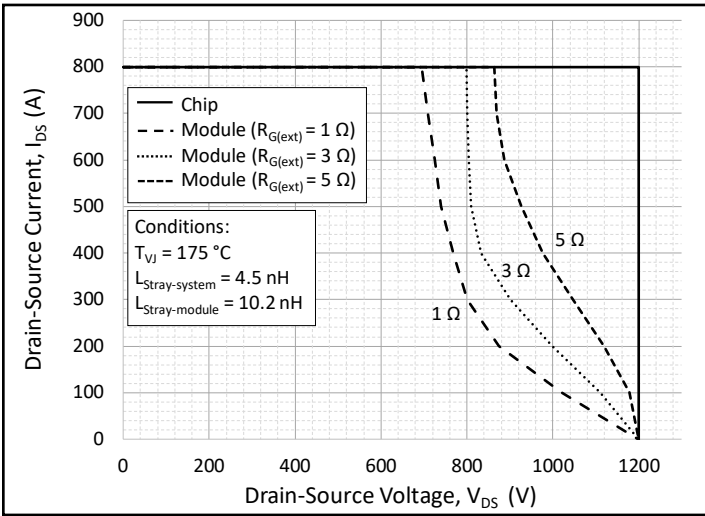

Figure 19. Reverse Bias Safe Operating Area (RBSOA)

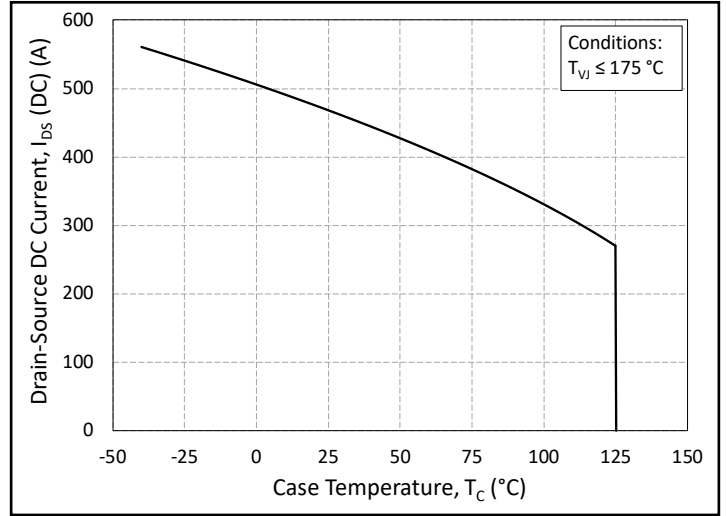

Figure 20. Continuous Drain Current Derating vs. Case Temperature

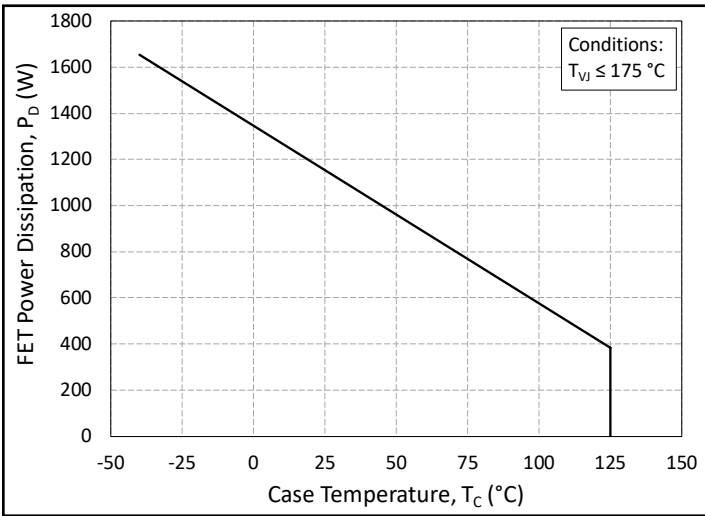

Figure 21. Maximum Power Dissipation Derating vs. Case Temperature

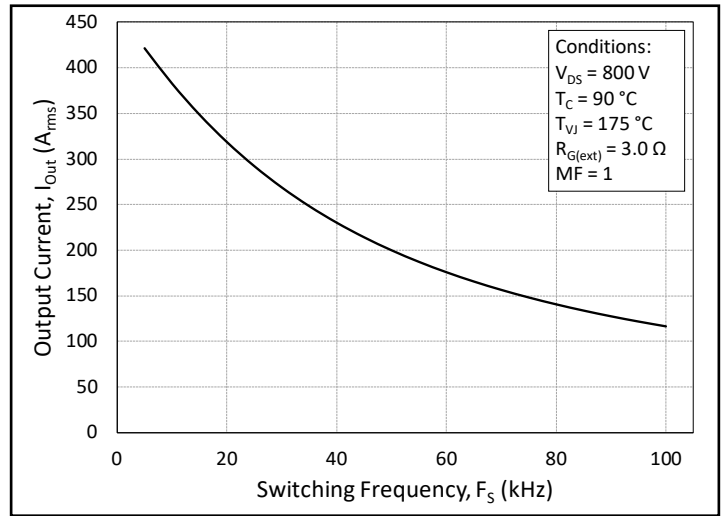

Figure 22. Typical Output Current Capability vs. Switching Frequency (Inverter Application)



Timing Characteristics

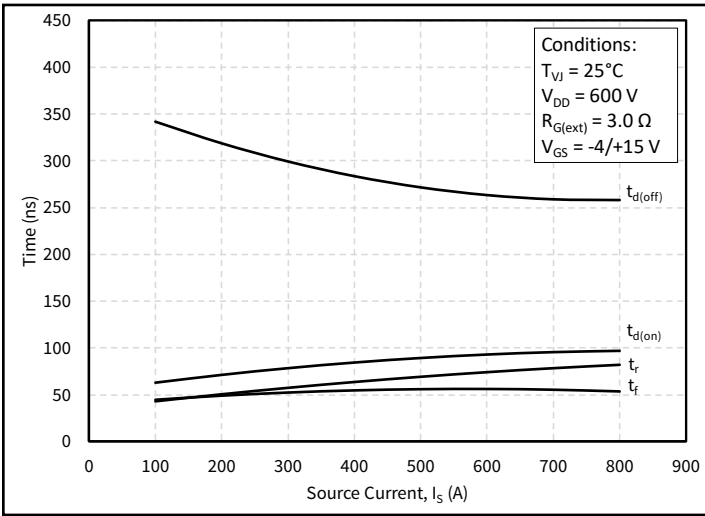

Figure 23. Timing vs. Source Current

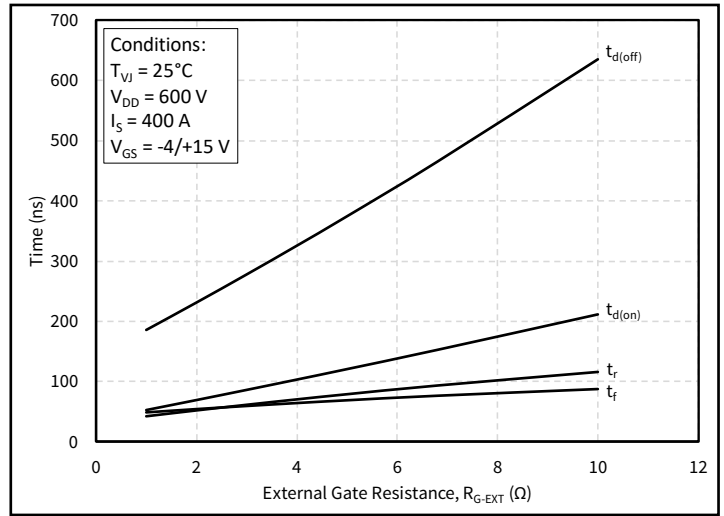

Figure 24. Timing vs. External Gate Resistance

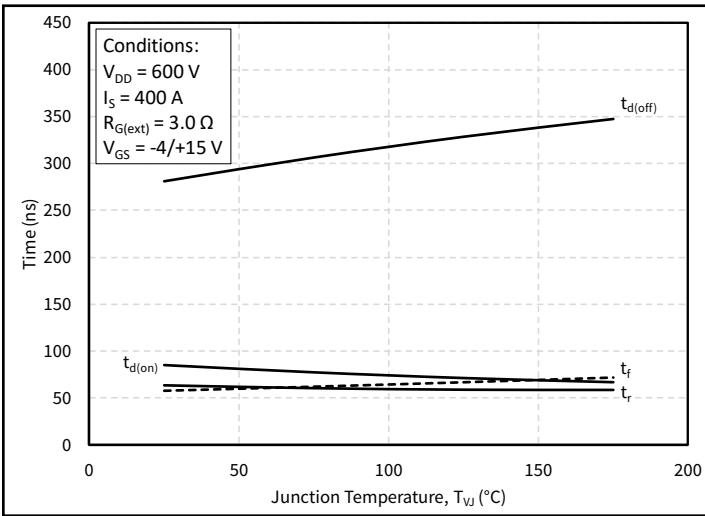

Figure 25. Timing vs. Junction Temperature

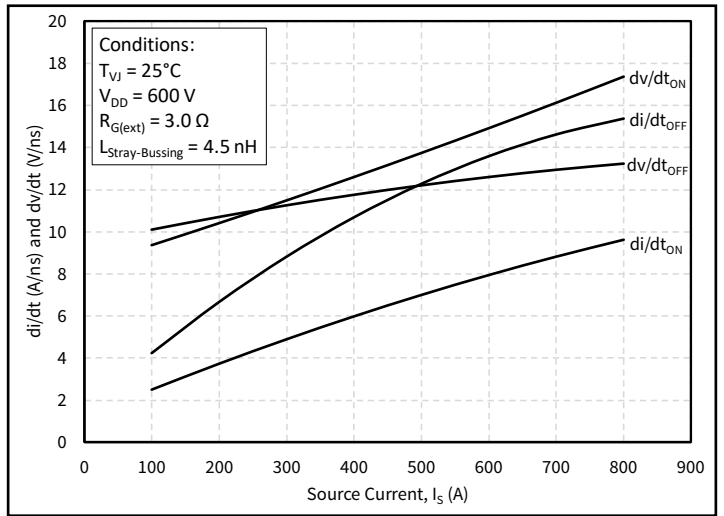

Figure 26. dv/dt and di/dt vs. Source Current

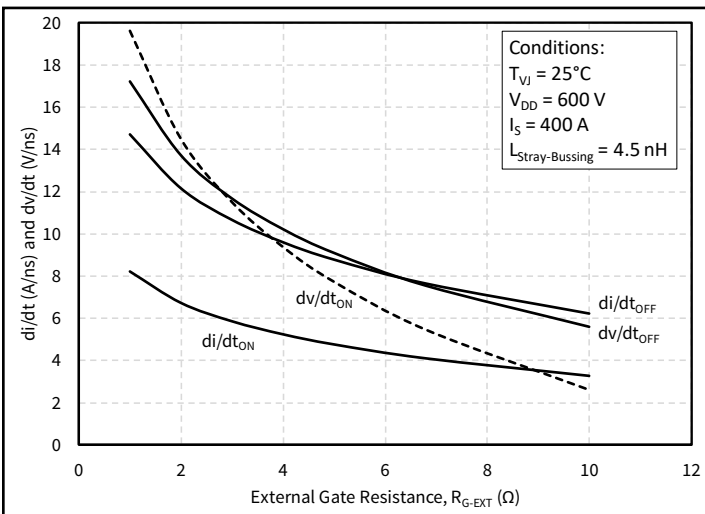

Figure 27. dv/dt and di/dt vs. External Gate Resistance

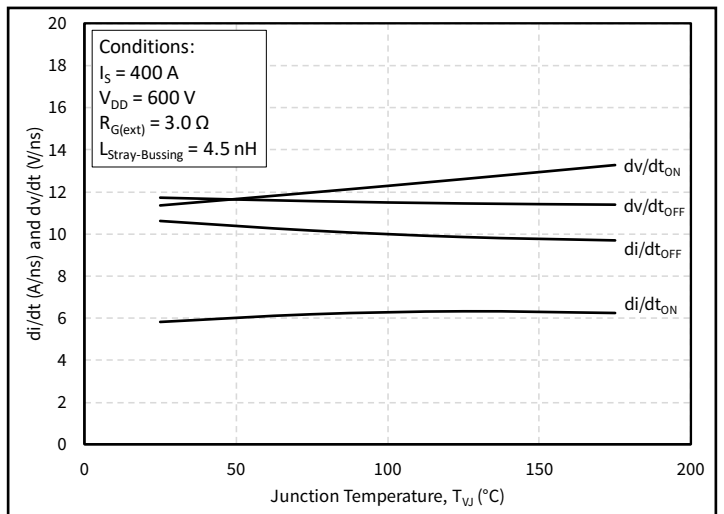

Figure 28. dv/dt and di/dt vs. Junction Temperature



Definitions

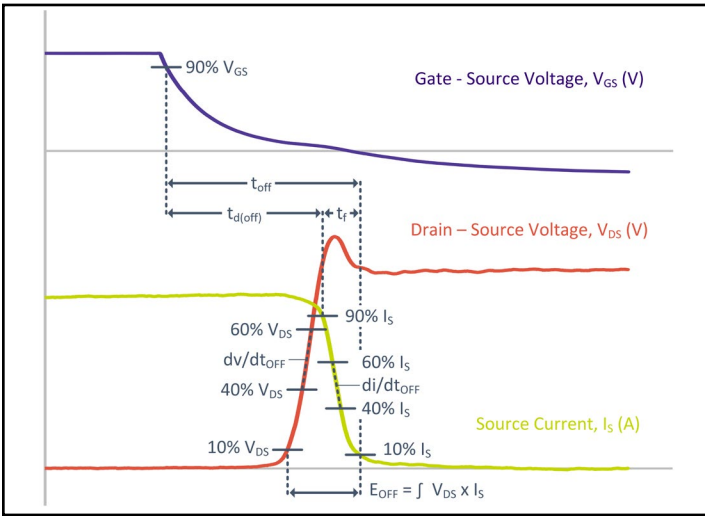

Figure 29. Turn-off Transient Definitions

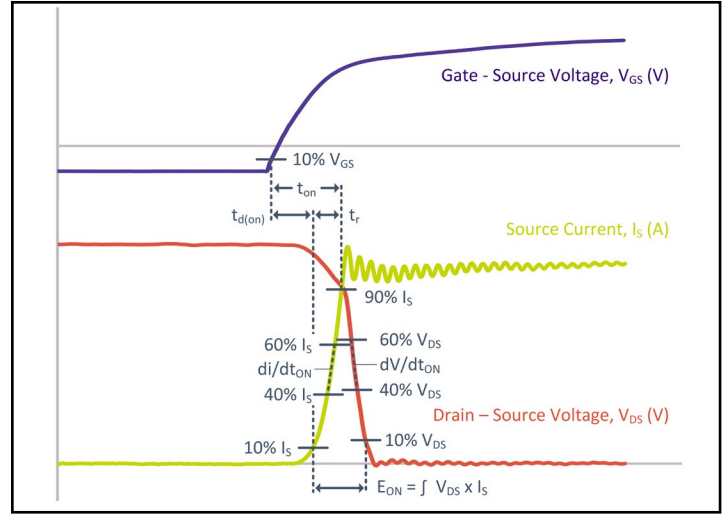

Figure 30. Turn-on Transient Definitions

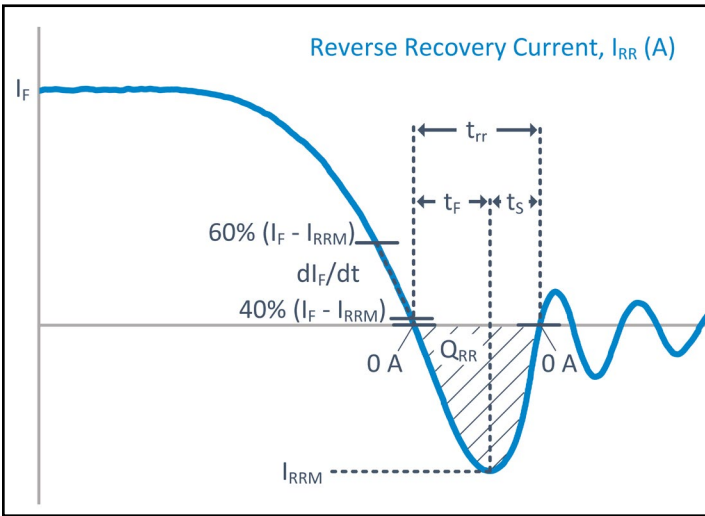

Figure 31. Reverse Recovery Definitions

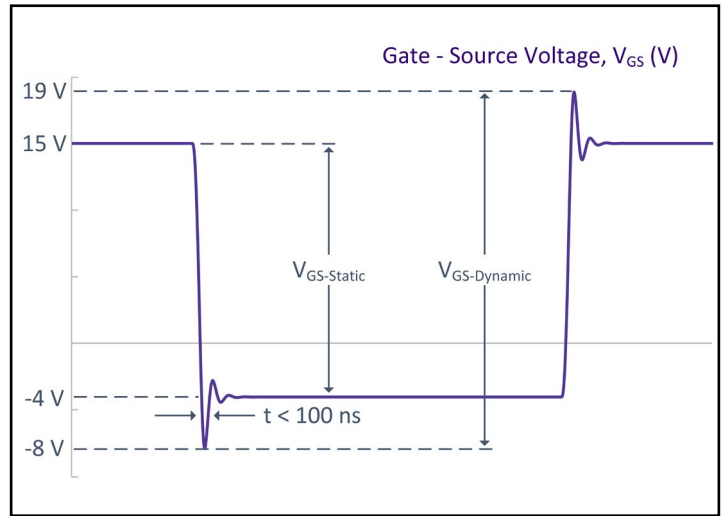
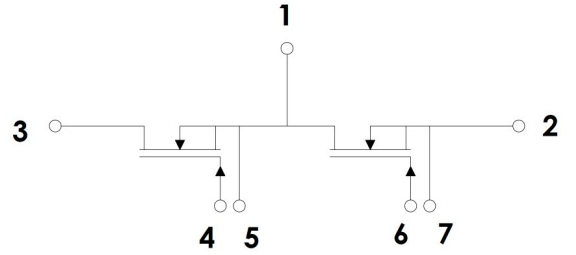
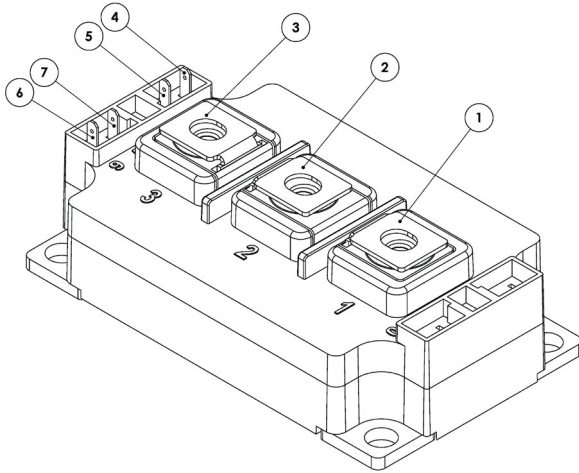

Figure 32. V_{GS} Transient Definitions



Schematic and Pin Out



Package Dimensions (mm)

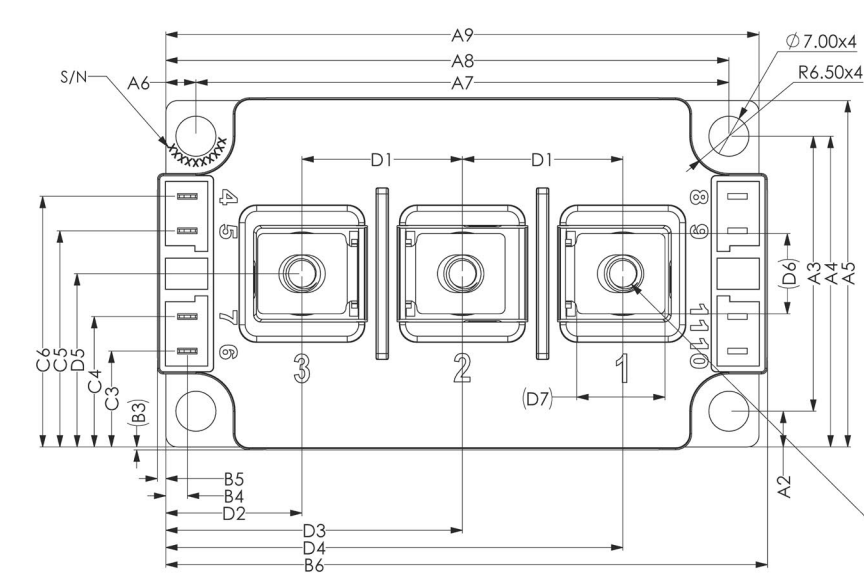

DIMENSION TABLE		
SYMBOL	DIMENSION (mm)	TOLERANCE (mm)
A1	3.00	+0.30
A2	4.22	+0.30
A3	48.00	+0.30
A4	54.22	+0.30
A5	60.44	+0.30
A6	5.25	+0.30
A7	93	+0.30
A8	98.25	+0.30
A9	103.50	+0.30
B1	22.75	+0.30
B2	27.30	+0.30
B3	0.51 x 2	REF
B4	3.76	+0.40
B5	1.25	+0.40
B6	105.00	+0.30
C1	30.60	+0.50
C2	31.40	+0.40
C3	16.72	+0.40
C4	22.75	+0.40
C5	37.7	+0.40
C6	43.73	+0.40
D1	28.00	+0.50
D2	24.20	+0.40
D3	52.00	+0.40
D4	79.80	+0.40
D5	30.22	+0.40
D6	14.00 x 3	REF
D7	15.40 x 3	REF

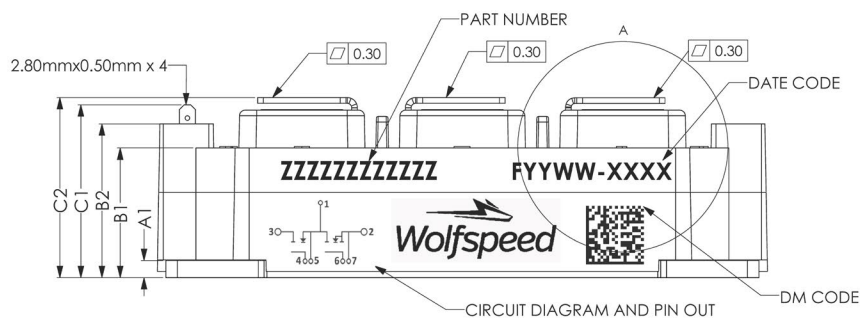

M6x6mm HEX NUT x 3
MAXIMUM BOLT PENETRATION DEPTH: 10mm

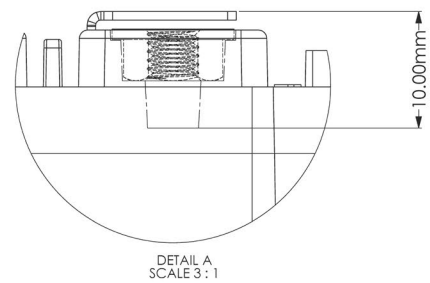

3D Model (Requires Adobe Acrobat or Compatible Viewer With 3D Capability)

Supporting Links & Tools

- [CGD1200HB2P-BM3 Evaluation Gate Driver](#)
- [CGD12HB00D: Differential Transceiver Board](#)
- [KIT-CRD-CIL12N-BM: Dynamic Performance Evaluation Board for the BM2 & BM3 Module \(CPWR-AN-36\)](#)
- [CPWR-AN-34: Module Mounting Application Note](#)
- [CPWR-AN-35: Thermal Interface Material Application Note](#)

Notes

- This product has not been designed or tested for use in, and is not intended for use in, applications implanted into the human body nor in applications in which failure of the product could lead to death, personal injury or property damage, including but not limited to equipment used in the operation of nuclear facilities, life-support machines, cardiac defibrillators or similar emergency medical equipment, aircraft navigation or communication or control systems, or air traffic control systems.
- The SiC MOSFET module switches at speeds beyond what is customarily associated with IGBT-based modules. Therefore, special precautions are required to realize optimal performance. The interconnection between the gate driver and module housing needs to be as short as possible. This will afford optimal switching time and avoid the potential for device oscillation. Also, great care is required to insure minimum inductance between the module and DC link capacitors to avoid excessive VDS overshoot.



X-ON Electronics

Largest Supplier of Electrical and Electronic Components

Click to view similar products for [Discrete Semiconductor Modules](#) category:

Click to view products by [Wolfspeed](#) manufacturer:

Other Similar products are found below :

[M252511FV](#) [M254043](#) [DD260N12K-A](#) [DD380N16A](#) [DDB6U144N16R](#) [DDB6U145N16L](#) [APT20M11JFLL](#) [APT2X101DL40J](#)
[APT2X21DC60J](#) [APT2X30D40J](#) [APT2X30D60J](#) [APT2X31DQ120J](#) [APT39M60J](#) [APT47M60J](#) [APT50DF170HJ](#) [APT50M50JLL](#)
[APT50M75JLLU3](#) [APT50N60JCCU2](#) [APT58M80J](#) [APT80F60J](#) [DZ540N26K](#) [B522F-2-YEC](#) [MSTC90-16](#) [MT16HTF12864AZ-800G1](#)
[MT18HTF12872PZ-667G1](#) [MT18HTF25672FDZ-667H1D6](#) [MT18HTF25672PZ-80EH1](#) [MT18RTF25672FDZ-667H1D6](#)
[MT36HTF51272FZ-667H1D4](#) [MT36HTF51272FZ-667H1D6](#) [MT8HTF12864HTZ-667H1](#) [MT9HTF6472PZ-667G1](#) [MT9HVF12872PZ-](#)
[80EH1](#) [MT9HVF6472PZ-667G1](#) [ND104N16K](#) [25.163.0653.1](#) [25.163.2453.0](#) [25.163.4253.0](#) [25.190.2053.0](#) [25.194.3453.0](#) [25.320.4853.1](#)
[25.320.5253.1](#) [25.325.3653.1](#) [25.326.3253.1](#) [25.326.3553.1](#) [25.330.1653.1](#) [25.330.4753.1](#) [25.330.5253.1](#) [25.334.3253.1](#) [25.334.3353.1](#)