

Description

The P6KE series of high current uni/bi-directional transient suppressors are designed for A.C. line protection and high power DC bus clamping applications. These devices offer uni/bi-directional port protection from 6.8 volts to 600 volts. They provide a clamping voltage lower than the avalanche voltage. Therefore, any voltage rise due to increased current conduction is contained to a minimum, providing the best possible protection level. They can also be connected in series and/or parallel to create very high capacity protection solutions.

Features

- Excellent clamping capability.
- Repetition rate (duty cycle): 0.01%.
- Color band denoted cathode except bidirectional.
- 600W Peak Pulse power capability at 10×1000μs waveform.
- Fast response time: typically less than 1.0ps from 0V to V_{BR} min.
- High temperature soldering: 260°C/10s at terminals.

Dimensions & Symbol (Unit: mm Max)

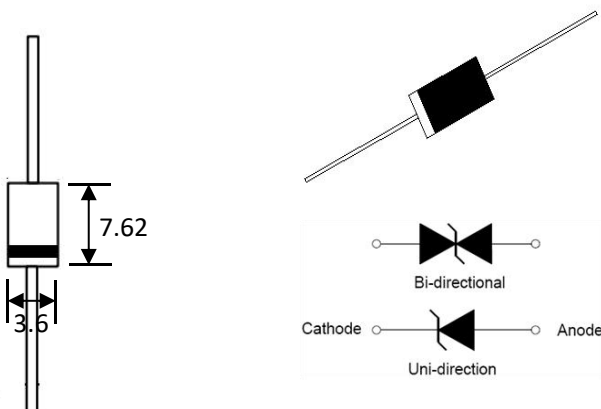

Mechanical Characteristics

Package: DO-15

- UL Flammability Classification Rating 94V-0
- Polarity: Color band denotes cathode except bi-directional models
- Standard Packaging: BOX
- Weight: 0.4g
- Terminal Connections: See Diagram Below
- Marking Information: See Below

Applications

- I/O Interface.
- AC/DC Power supply
- Other vulnerable circuits used in Telecom, Computer, Industrial and Consumer electronic applications

Marking Information

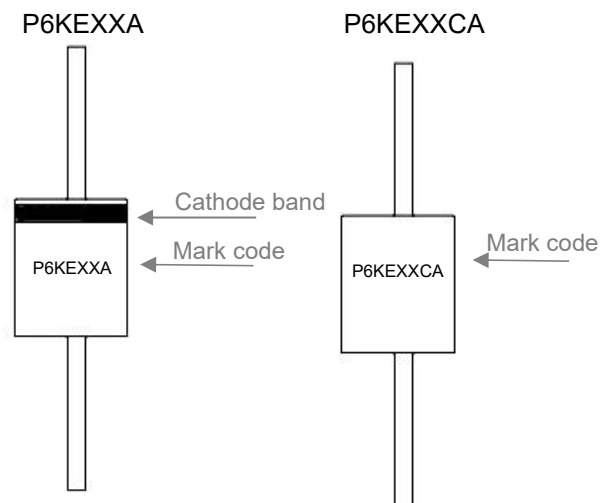

Ordering Information

Out line	Reel (pcs)	Percarton (pcs)	Packing Option
Taping	2K	20K	box

Electrical Characteristics ($T_A=25^\circ\text{C}$)

Part Number		V_R	$I_{R@V_R}$	$V_{BR@I_T}$		I_T	$V_C@I_{PP}$	$I_{PP}^{\text{①}}$
Uni-Polar	Bi-Polar	V	μA	min(V)	max(V)	mA	max(V)	A
P6KE6.8A	P6KE6.8CA	5.8	150	6.45	7.14	10	10.5	58.1
P6KE7.5A	P6KE7.5CA	6.4	120	7.13	7.88	10	11.3	54.0
P6KE8.2A	P6KE8.2CA	7.02	50	7.79	8.61	10	12.1	50.4
P6KE9.1A	P6KE9.1CA	7.78	20	8.65	9.55	1	13.4	45.5
P6KE10A	P6KE10CA	8.55	10	9.50	10.50	1	14.5	42.1
P6KE11A	P6KE11CA	9.4	5	10.50	11.60	1	15.6	39.1
P6KE12A	P6KE12CA	10.2	2	11.40	12.60	1	16.7	36.5
P6KE13A	P6KE13CA	11.1	1	12.40	13.70	1	18.2	33.5
P6KE15A	P6KE15CA	12.8	1	14.30	15.80	1	21.2	28.8
P6KE16A	P6KE16CA	13.6	1	15.20	16.80	1	22.5	27.1
P6KE18A	P6KE18CA	15.3	1	17.10	18.90	1	25.2	24.2
P6KE20A	P6KE20CA	17.1	1	19.00	21.00	1	27.7	22.0
P6KE22A	P6KE22CA	18.8	1	20.90	23.10	1	30.6	19.9
P6KE24A	P6KE24CA	20.5	1	22.80	25.20	1	33.2	18.4
P6KE27A	P6KE27CA	23.1	1	25.70	28.40	1	37.5	16.3
P6KE30A	P6KE30CA	25.6	1	28.50	31.50	1	41.4	14.7
P6KE33A	P6KE33CA	28.2	1	31.40	34.70	1	45.7	13.3
P6KE36A	P6KE36CA	30.8	1	34.20	37.80	1	49.9	12.2
P6KE39A	P6KE39CA	33.3	1	37.10	41.00	1	53.9	11.3
P6KE43A	P6KE43CA	36.8	1	40.90	45.20	1	59.3	10.3
P6KE47A	P6KE47CA	40.2	1	44.70	49.40	1	64.8	9.4
P6KE51A	P6KE51CA	43.6	1	48.50	53.60	1	70.1	8.7
P6KE56A	P6KE56CA	47.8	1	53.20	58.80	1	77.0	7.9
P6KE62A	P6KE62CA	53.0	1	58.90	65.10	1	85.0	7.9
P6KE68A	P6KE68CA	58.1	1	64.60	71.40	1	92.0	6.6
P6KE75A	P6KE75CA	64.1	1	71.30	78.80	1	103.0	5.9
P6KE82A	P6KE82CA	70.1	1	77.90	86.10	1	113.0	5.4
P6KE91A	P6KE91CA	77.8	1	86.50	95.50	1	125.0	4.9
P6KE100A	P6KE100CA	85.5	1	95.00	105.0	1	137.0	4.5

Electrical Characteristics ($T_A=25^\circ\text{C}$, continued)

Part Number		V_R	$I_R@V_R$	$V_{BR}@I_T$		I_T	$V_C@I_{PP}$	$I_{PP}^{①}$
Uni-Polar	Bi-Polar	V	μA	min(V)	max(V)	mA	max(V)	A
P6KE110A	P6KE110CA	94.0	1	105.0	116.0	1	152.0	4.0
P6KE120A	P6KE120CA	102.0	1	114.0	126.0	1	165.0	3.7
P6KE130A	P6KE130CA	111.0	1	124.0	137.0	1	179.0	3.4
P6KE150A	P6KE150CA	128.0	1	143.0	158.0	1	207.0	2.9
P6KE160A	P6KE160CA	136.0	1	152.0	168.0	1	219.0	2.8
P6KE170A	P6KE170CA	145.0	1	162.0	179.0	1	234.0	2.6
P6KE180A	P6KE180CA	154.0	1	171.0	189.0	1	246.0	2.5
P6KE200A	P6KE200CA	171.0	1	190.0	210.0	1	274.0	2.2
P6KE220A	P6KE220CA	185.0	1	209.0	231.0	1	328.0	1.9
P6KE250A	P6KE250CA	214.0	1	237.0	263.0	1	344.0	1.8
P6KE300A	P6KE300CA	256.0	1	285.0	315.0	1	414.0	1.5
P6KE350A	P6KE350CA	300.0	1	332.0	368.0	1	482.0	1.3
P6KE400A	P6KE400CA	342.0	1	380.0	420.0	1	548.0	1.1
P6KE440A	P6KE440CA	376.0	1	418.0	462.0	1	602.0	1.0
P6KE480A	P6KE480CA	408.0	1	456.0	504.0	1	658.0	0.9
P6KE510A	P6KE510CA	434.0	1	485.0	535.0	1	698.0	0.9
P6KE540A	P6KE550CA	460.0	1	513.0	567.0	1	740.0	0.8
P6KE550A	P6KE550CA	468.0	1	522.5	577.5	1	760.0	0.8
P6KE600A	P6KE600CA	512.0	1	570.0	630.0	1	828.0	0.75

① Surge waveform: 10/1000 μs

V_R : Stand-off Voltage -- Maximum voltage that can be applied

V_{BR} : Breakdown Voltage

V_C : Clamping Voltage -- Peak voltage measured across the suppressor at a specified I_{pp}

I_R : Reverse Leakage Current

Part Number Code

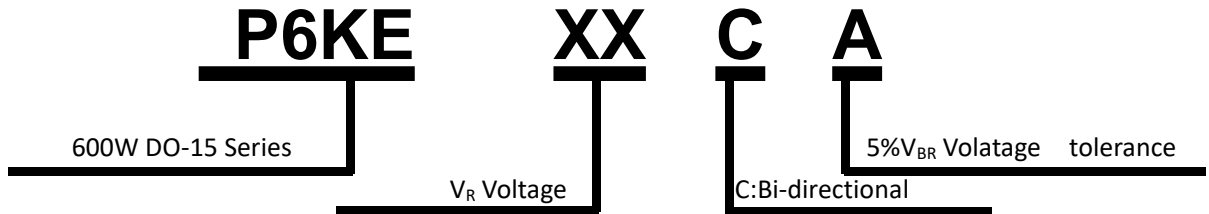

Absolute Maximum Ratings ($T_A=25^{\circ}\text{C}$, $\text{RH}=45\%-75\%$, unless otherwise noted)

Parameter	Symbol	Value	Unit
Peak pulse power dissipation on 10/1000 μs waveform	P_{PP}	600	W
Steady state power dissipation at $T_L=75^{\circ}\text{C}$	$P_{M(AV)}$	5.0	W
Operating junction and Storage temperature range	T_{STG}, T_J	-55 to +150	$^{\circ}\text{C}$
Peak forward surge current, 8.3ms single half sine-wave	I_{FSM}	100	A

Ratings And V-I Characteristics Curves ($T_A=25^{\circ}\text{C}$, unless otherwise noted)

FIG.1:V- I curve characteristics (Uni-directional)

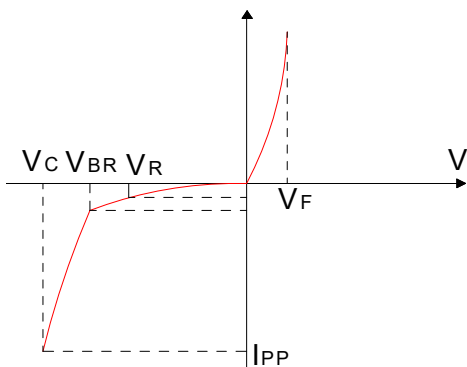

FIG.2:V- I curve characteristics (Bi-directional)

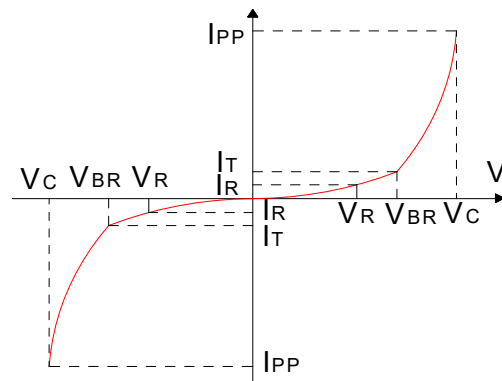

FIG.3: Pulse waveform

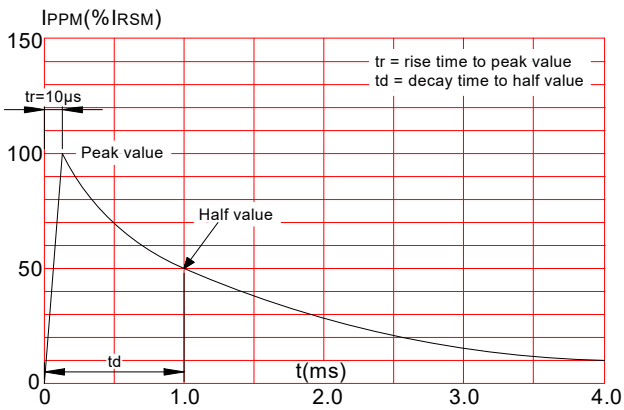
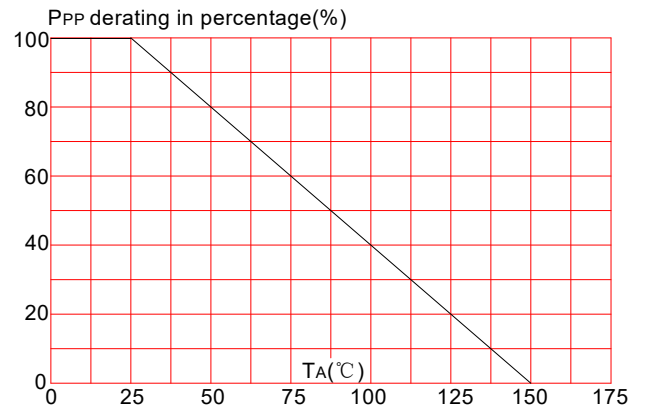
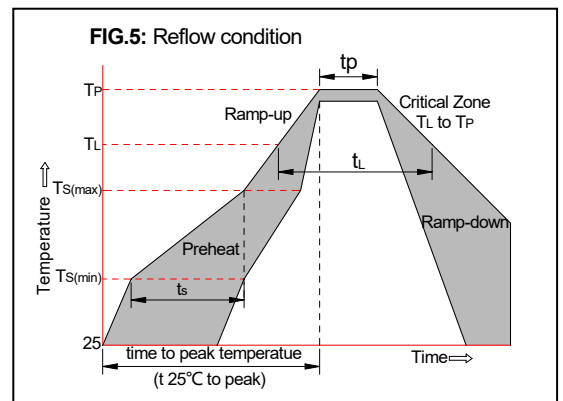

FIG.4: Pulse derating curve



Soldering Parameters

Reflow Condition		Pb-Free assembly (see FIG.5)
Pre Heat	-Temperature Min ($T_{s(min)}$)	+150°C
	-Temperature Max($T_{s(max)}$)	+200°C
	-Time (Min to Max) (t_s)	60-180 secs.
Average ramp up rate (Liquid us Temp (T_L) to peak)		3°C/sec. Max
$T_{s(max)}$ to T_L - Ramp-up Rate		3°C/sec. Max
Reflow	-Temperature(T_L)(Liquid us)	+217°C
	-Temperature(t_L)	60-150 secs.
Peak Temp (T_p)		+260(+0/-5)°C
Time within 5°C of actual Peak Temp (t_p)		30 secs. Max
Ramp-down Rate		6°C/sec. Max
Time 25°C to Peak Temp (T_P)		8 min. Max
Do not exceed		+260°C



Package Mechanical Data

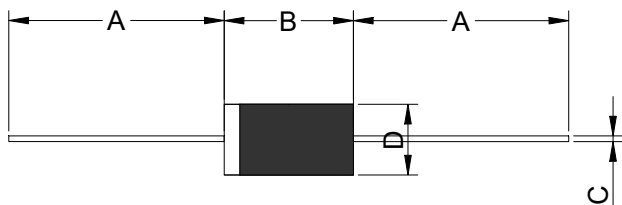

Ref.	Dimensions			
	Inches		Millimeters	
	Min.	Max.	Min.	Max.
A	1.000	-	25.40	-
B	0.228	0.300	5.80	7.62
C	0.027	0.035	0.69	0.89
D	0.118	0.140	3.00	3.60

Tape & Reel Specification – DO-15

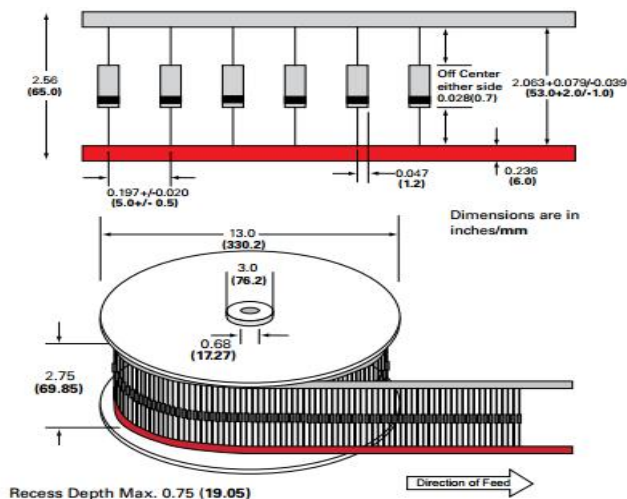

Contact Information

WPMTEK Incorporated Limited

Floor 1 Building 4#, Binxianghua Industry Park, No.7,

Huada Road, Hualian Community, Longhua New District, Shenzhen

TEL: 86755-29308003 FAX: 86755-23739900

wpmtek Incorporated Limited (WPM) reserves the right to make changes to the product specification and data in this document without notice. WPM makes no warranty, representation or guarantee regarding the suitability of its products for any particular purpose, nor does WPM assume any liability arising from the application or use of any products or circuits, and specifically dis-claims any and all liability, including without limitation special, consequential or incidental damages.

X-ON Electronics

Largest Supplier of Electrical and Electronic Components

Click to view similar products for [ESD Suppressors / TVS Diodes](#) category:

Click to view products by [WPMtek](#) manufacturer:

Other Similar products are found below :

[60KS200C](#) [D18V0L1B2LP-7B](#) [D5V0F4U5P5-7](#) [NTE4902](#) [P4KE27CA](#) [P6KE11CA](#) [P6KE8.2A](#) [SA60CA](#) [SA64CA](#) [SMBJ12CATR](#)
[SMBJ33CATR](#) [SMBJ6.5A](#) [SMBJ8.0A](#) [ESD101-B1-02ELS E6327](#) [ESD112-B1-02EL E6327](#) [ESD7451N2T5G](#) [19180-510](#) [CPDT-5V0USP-](#)
[HF](#) [3.0SMCJ33CA-F](#) [3.0SMCJ36A-F](#) [HSPC16701B02TP](#) [JANTX1N6126A](#) [D3V3Q1B2DLP3-7](#) [D55V0M1B2WS-7](#) [SCM1293A-04SO](#)
[ESD200-B1-CSP0201 E6327](#) [SM12-7](#) [CEN955 W/DATA](#) [VESD12A1A-HD1-GS08](#) [CPDQC5V0-HF](#) [D1213A-01LP4-7B](#) [ESD101-B1-02EL](#)
[E6327](#) [AOZ8808DI-03](#) [5KP15A](#) [5KP48A](#) [5KP90A](#) [ESD3V3D7-TP](#) [15KPA36A-LF](#) [P4KE56CA](#) [P4KE68A](#) [P4KE91CATR](#) [P6KE120A](#)
[P6KE13CA](#) [P6KE43CA](#) [P6KE6.8CA](#) [P6KE8.2](#) [P6SMBJ20CA](#) [JANTX1N6072A](#) [SR2835ESKG](#) [SA90CA](#)