

## Features

- Low Power Consumption: 1.5μA (Typ)
- Maximum Output Current: 150mA
- Small Dropout Voltage  
300mV@100mA (Vout=3.3V)
- High Input Voltage: Up to 36V
- High Accurate:
- RoHS Compliant and Lead (Pb) Free
- Good Transient Response
- Integrated Short-Circuit Protection
- Over-Temperature Protection
- Output Current Limit
- Stable with Ceramic Capacitor
- Support Fixed Output Voltage:  
1.8,2.5,2.8,3.0,3.3,3.6,4.0,4.2,4.4 and 5.0V
- Available Package:  
SOT23-3L\SOT89-3L\DFN4\DFN3\SOT23-5L

## Application

- Portable, Battery Powered Equipment
- Battery-powered equipment
- Weighting Scales
- Smoke detector and sensor
- Audio/Video Equipmen
- Home Automation

## Description

The WL9100 series is a high voltage, ultralow-power, low dropout voltage regulator. The device can deliver 150mA output current with a dropout voltage of 300mV and allows an input voltage as high as 36V. The typical quiescent current is only 1.5μA. The device is available in fixed output voltages of 1.8,2.5,2.8,3.0,3.3,3.6,4.0,4.2,4.4 and 5.0V.The device features integrated short-circuit and thermal shutdown protection.Although designed primarily as fixed voltage regulators, the device can be used with external components to obtain variable voltages.

## Application Circuits

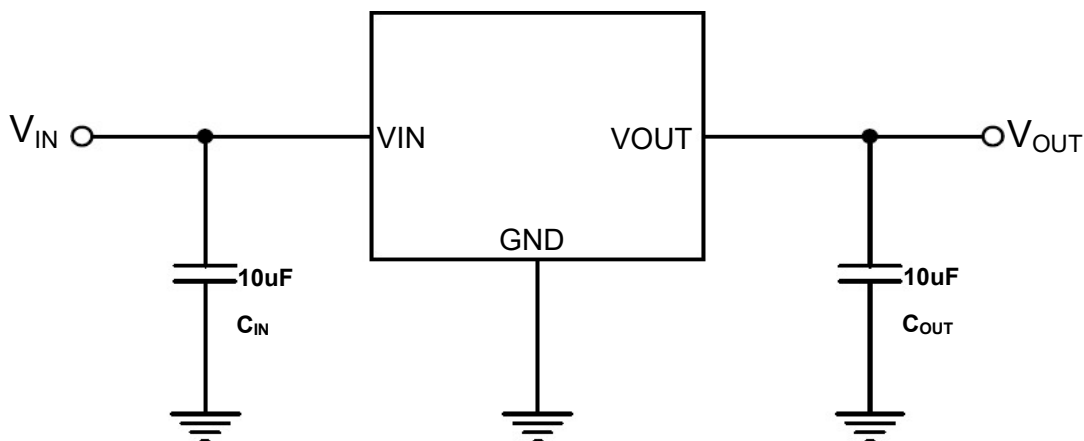

## Pin Configuration

### SOT23-3L:

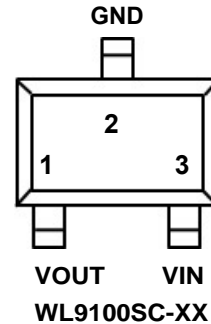
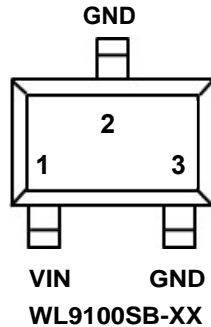
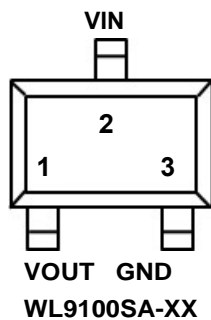
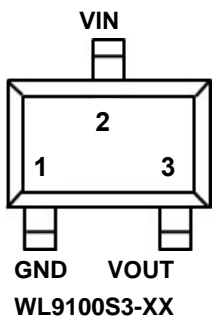

### SOT89-3L:

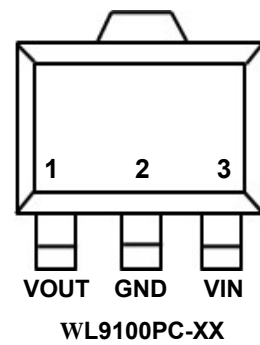
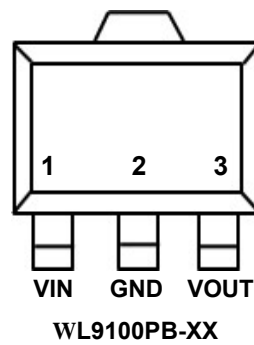
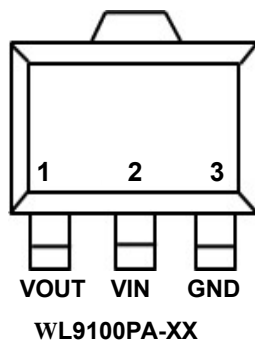
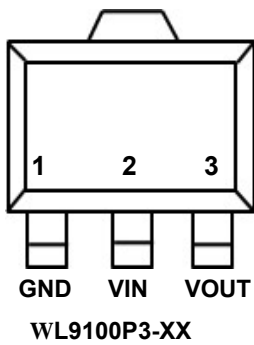

### DFN1x1-4L:

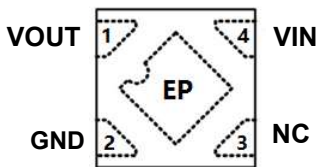

### DFN2x2-3L:

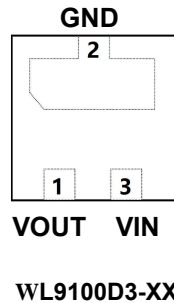

### SOT23-5L:

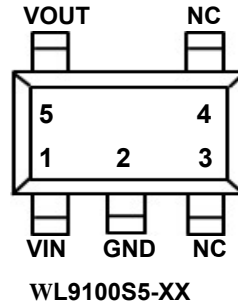

## Pin Description

SOT23-3L Pin No.				Pin Name	Pin Function
WL9100S3-XX	WL9100SA-XX*	WL9100SB-XX	WL9100SC-XX		
1	3	2	2	GND	Ground.
2	2	1	3	VIN	Supply voltage input
3	1	3	1	VOUT	Voltage Output
SOT89-3L Pin No.				Pin Name	Pin Function
WL9100P3-XX	WL9100PA-XX*	WL9100PB-XX	WL9100PC-XX		
1	3	2	2	GND	Ground.
2	2	1	3	VIN	Supply voltage input
3	1	3	1	VOUT	Voltage Output

Pin No.			Pin Name	Pin Function
DFN1x1-4L	DFN2x2-3L	SOT23-5L		
1	1	5	VOUT	Voltage Output
2	2	2	GND	Ground
3	-----	3、4	NC	No Internal Connection
4	3	1	VIN	Supply voltage input

**NOTE: (\*) It needs to be customized**

## Order Information

**WL9100①②-③④⑤**

Designator	Symbol	Description
①②	S3/P3/D4/D3/S5	SOT23-3L / SOT89-3L / DFN4L / DFN3L / SOT23-5L
③④	Integer	Output Voltage 1.8,2.5,2.8,3.0,3.3,3.6,4.0,4.2,4.4 and 5.0V
⑤	A	Accurate ±1%
	B	Accurate ±2%

Model	Marking	Description	Package	T/R Qty
WL9100S3-XX*	AFXXA(B)	WL9100 36V;1.5μA IQ, 150mA Low-Dropout LDO	SOT23-3L	3,000 PCS
WL9100P3-XX*	AFXXA(B)		SOT89-3L	1,000 PCS
WL9100S5-XX*	AFXXA(B)		SOT23-5L	3,000 PCS
WL9100D4-XX*	**		DFN1X1-4L	10,000 PCS
WL9100D3-XX*	**		DFN2X2-3L	1,000 PCS

Note: (\*) XX Represents the Output Voltage

(\*\*) Please Page 4 . Only Off DFN1x1-4L and DFN2x2-3L (customized)

## Marking Information

SOT23-3L , SOT23-5L and SOT89-3L Marking: ①②③④⑤

①②Represents the product name

Mark ①②	Product Series
AF	WL9100 S3 / S5 / P3

③④Represents the Output Voltage

Mark	Output Voltage (V)			Mark	Output Voltage (V)		
18	—	1.8	—	36	—	3.6	—
25	—	2.5	—	40	—	4.0	—
28	—	2.8	—	42	—	4.2	—
30	—	3.0	—	44	—	4.4	—
33	—	3.3	—	50	—	5.0	—

⑤Represents the Output Voltage Accurate

Mark⑤		Product Series
±1% Output Voltage	±2% Output Voltage	WL9100 (A or B)
A	B	

DFN1X1-4L and DFN2X2-3L Marking:

Mark	Output Voltage (V) Accurate ±1%			Mark	Output Voltage (V) Accurate ±2%		
<u>AF</u>	—	1.8	—	AF	—	1.8	—
<u>BF</u>	—	2.5	—	BF	—	2.5	—
<u>CF</u>	—	2.8	—	CF	—	2.8	—
<u>DF</u>	—	3.0	—	DF	—	3.0	—
<u>EF</u>	—	3.3	—	EF	—	3.3	—
<u>GF</u>	—	4.6	—	GF	—	4.6	—
<u>HF</u>	—	4.0	—	HF	—	4.0	—
<u>KF</u>	—	4.2	—	KF	—	4.2	—
<u>MF</u>	—	4.4	—	MF	—	4.4	—
<u>LF</u>	—	5.0	—	LF	—	5.0	—

## Absolute Maximum Ratings <sup>(1) (2)</sup>

Parameter		Symbol	Maximum Rating	Unit
Input Voltage		V <sub>IN</sub>	V <sub>SS</sub> -0.3~V <sub>SS</sub> +42.0	V
		V <sub>OUT</sub>	V <sub>SS</sub> -0.3~V <sub>SS</sub> +6.0	V
Output Current		I <sub>OUT</sub>	150	mA
Power Dissipation	SOT23-3L/5L	P <sub>d</sub>	400	mW
	SOT89-3L		500	
	DFN1x1-4L		400	
	DFN2x2-3L		500	
Thermal Resistance	SOT23-3L/5L	R <sub>θJA</sub> <sup>(3)</sup>	250	°C/W
	SOT89-3L		200	°C/W
	DFN1x1-4L		250	
	DFN2x2-3L		200	
Operating Temperature		T <sub>opr</sub>	-40~85	°C
Storage Temperature		T <sub>stg</sub>	-40~125	°C
Soldering Temperature & Time		T <sub>solder</sub>	260°C, 10s	

Note (1): Exceeding these ratings may damage the device.

Note (2): The device is not guaranteed to function outside of its operating conditions

Note (3): The package thermal impedance is calculated in accordance to JESD 51-7.

## ESD Ratings

Item	Description	Value	Unit
V <sub>(ESD-HBM)</sub>	Human Body Model (HBM) ANSI/ESDA/JEDEC JS-001-2014 Classification, Class: 2	±4000	V
V <sub>(ESD-CDM)</sub>	Charged Device Mode (CDM) ANSI/ESDA/JEDEC JS-002-2014 Classification, Class: C0b	±100	V
I <sub>LATCH-UP</sub>	JEDEC STANDARD NO.78E APRIL 2016 Temperature Classification, Class: I	±150	mA

ESD testing is performed according to the respective JESD22 JEDEC standard. The human body model is a 100 pF capacitor discharged through a 1.5kΩ resistor into each pin. The machine model is a 200pF capacitor discharged directly into each pin.

## Recommended Operating Conditions

Parameter	MIN.	MAX.	Units
Supply voltage at V <sub>IN</sub>	3.0	24	V
Operating junction temperature range, T <sub>j</sub>	-40	125	°C
Operating free air temperature range, T <sub>A</sub>	-40	85	°C

Note : All limits specified at room temperature (T<sub>A</sub> = 25°C) unless otherwise specified. All room temperature limits are 100% production tested. All limits at temperature extremes are ensured through correlation using standard Statistical Quality Control (SQC) methods. All limits are used to calculate Average Outgoing Quality Level (AOQL).

## Electrical Characteristics

(Test Conditions:  $V_{IN}=12V$ ,  $V_{OUT}=V_{set}$ ,  $C_{IN}=10\mu F$ ,  $C_{OUT}=10\mu F$ ,  $T_A=25^{\circ}C$ , unless otherwise specified.)

Parameter	Symbol	Conditions	Min	Typ	Max	Units
Input Voltage	$V_{IN}$		3.0	—	36	V
Supply Current	$I_Q$	$V_{IN}=12V$ $I_{LOAD}=0mA$	—	1.5	3.0	uA
Output Voltage WL9100 (A)	$V_{OUT1}$	$V_{IN}=12V$ $I_{OUT}=10mA$	$V_{set} \cdot 0.99$	$V_{set}$	$V_{set} \cdot 1.01$	V
Output Voltage WL9100 (B)	$V_{OUT2}$	$V_{IN}=12V$ $I_{OUT}=10mA$	$V_{set} \cdot 0.98$	$V_{set}$	$V_{set} \cdot 1.02$	V
Maximum Output Current	$I_{OUT(Max)}$	—	—	150	—	mA
Dropout Voltage	$V_{DROP}$ $V_{OUT}=3.0V$	$I_{OUT}=150mA$	—	550	—	mV
		$I_{OUT}=100mA$	—	330	—	
	$V_{DROP}$ $V_{OUT}=3.3V$	$I_{OUT}=150mA$	—	500	—	
		$I_{OUT}=100mA$	—	300	—	
	$V_{DROP}$ $V_{OUT}=5.0V$	$I_{OUT}=150mA$	—	520	—	
		$I_{OUT}=100mA$	—	300	—	
Line Regulation	$\frac{\Delta V_{OUT}}{\Delta V_{IN} \cdot V_{OUT}}$	$I_{OUT}=10mA$ $(V_{set}+2.0V) \leq V_{IN} \leq 24V$	—	0.15	—	%/V
Load Regulation	$\Delta V_{OUT}$	$V_{IN}=10V$ $1mA \leq I_{OUT} \leq 150mA$	—	45	—	mV
Short Current	$I_{SHORT}$	$R_L=1\Omega$	—	80	—	mA
Output Noise Voltage	$e_{NO}$	$I_{OUT}=50mA$ BW = 300Hz~50kHz	—	50	—	uV <sub>RMS</sub>
Output Voltage Temperature Coefficient	$\frac{\Delta V_{OUT}}{\Delta T \cdot V_{OUT}}$	$I_{OUT}=10mA$	—	100	—	ppm/ $^{\circ}C$

## Function Block Diagram

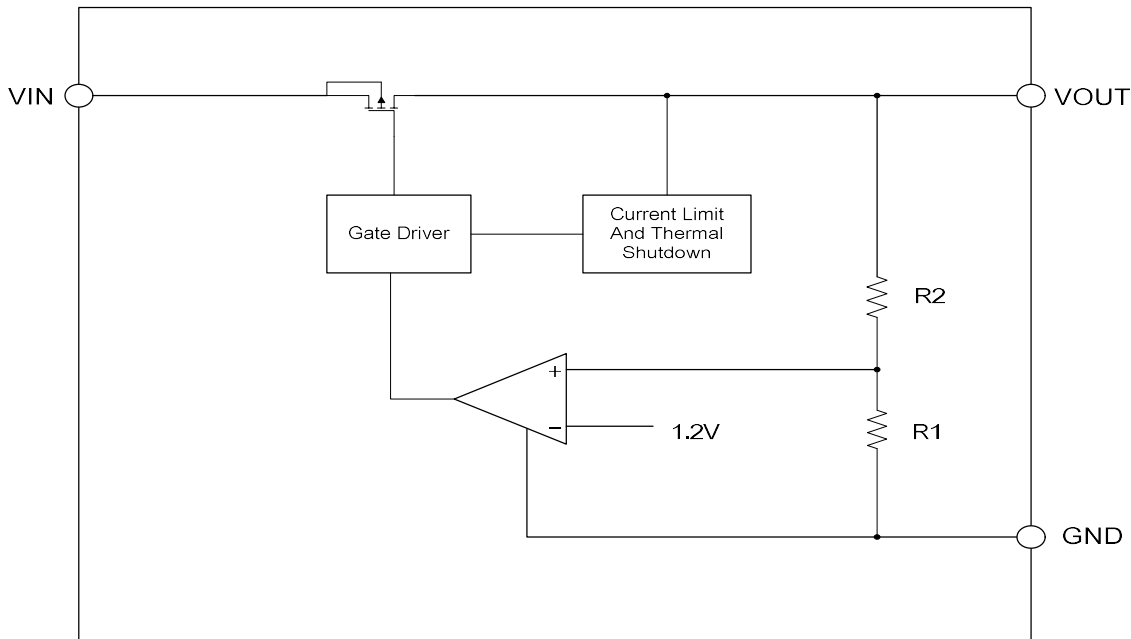

## Application Guideline

### Input Capacitor

A 10μF ceramic capacitor is recommended to connect between  $V_{DD}$  and GND pins to decouple input power supply glitch and noise. The amount of the capacitance may be increased without limit. This input capacitor must be located as close as possible to the device to assure input stability and less noise. For PCB layout, a wide copper trace is required for both VIN and GND.

### Output Capacitor

An output capacitor is required for the stability of the LDO. The recommended output capacitance is 10μF, ceramic capacitor is recommended, and temperature characteristics are X7R or X5R. Higher capacitance values help to improve load/line transient response. The output capacitance may be increased to keep low undershoot/overshoot. Place output capacitor as close as possible to VOUT and GND pins.

### Dropout Voltage

The dropout voltage refers to the voltage difference between the VIN and VOUT pins while operating at specific output current. The dropout voltage  $V_{DROP}$  also can be expressed as the voltage drop on the pass-FET at specific output current ( $I_{RATED}$ ) while the pass-FET is fully operating at ohmic region and the pass-FET can be characterized as a resistance  $R_{DS(ON)}$ . Thus the dropout voltage can be defined as ( $V_{DROP} = V_{IN} - V_{OUT} = R_{DS(ON)} \times I_{RATED}$ ). For normal operation, the

suggested LDO operating range is ( $V_{IN} > V_{OUT} + V_{DROP}$ ) for good transient response and PSRR ability. Vice versa, while operating at the ohmic region will degrade the performance severely.

### **Thermal Application**

For continuous operation, do not exceed the absolute maximum junction temperature. The maximum power dissipation depends on the thermal resistance of the IC package, PCB layout, rate of surrounding airflow, and difference between junction and ambient temperature. The maximum power dissipation can be calculated as below:  $T_A=25^{\circ}\text{C}$ , PCB,

The max  $PD = (125^{\circ}\text{C} - 25^{\circ}\text{C}) / (\text{Thermal Resistance } ^{\circ}\text{C/W})$

Power dissipation (PD) is equal to the product of the output current and the voltage drop across the output pass element, as shown in the equation below:

$$PD = (V_{IN} - V_{OUT}) \times I_{OUT}$$

### **Layout Consideration**

By placing input and output capacitors on the same side of the PCB as the LDO, and placing them as close as is practical to the package can achieve the best performance. The ground connections for input and output capacitors must be back to the WL9100 ground pin using as wide and as short of a copper trace as is practical. Connections using long trace lengths, narrow trace widths, and/or connections through via must be avoided. These add parasitic inductances and resistance that results in worse performance especially during transient conditions.



## Packaging Information

### SOT23-3L

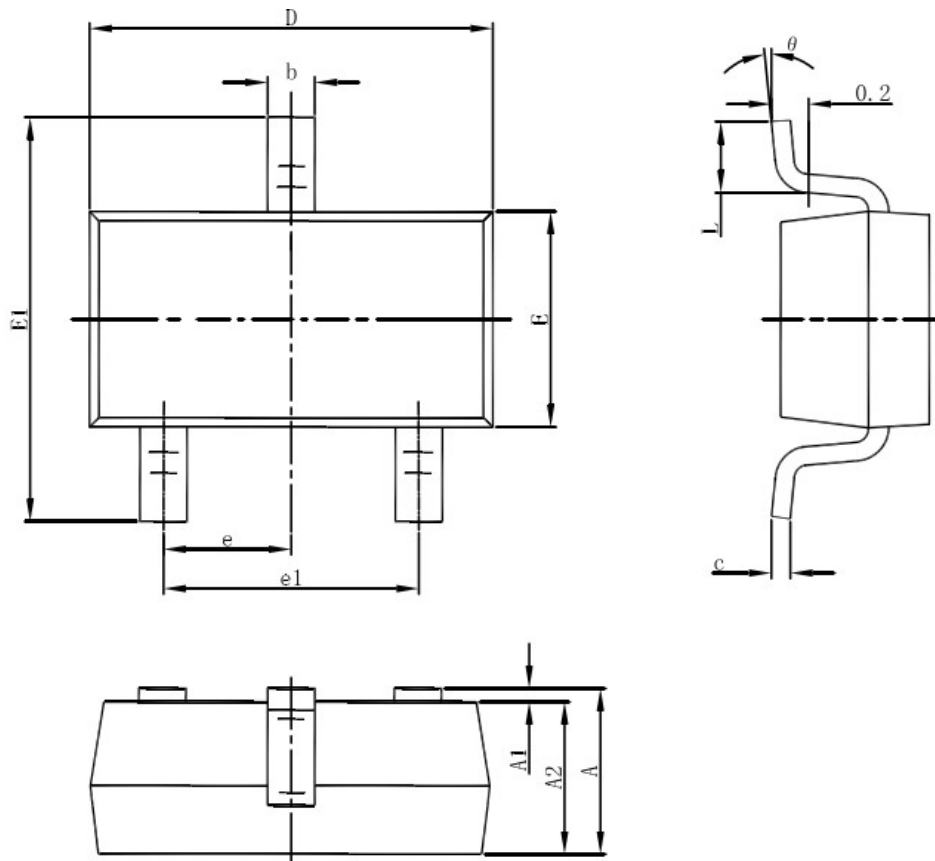

Symbol	Dimensions In Millimeters		Dimensions In Inches	
	Min	Max	Min	Max
A	1.050	1.250	0.041	0.049
A1	0.000	0.100	0.000	0.004
A2	1.050	1.150	0.041	0.045
b	0.300	0.500	0.012	0.020
c	0.100	0.200	0.004	0.008
D	2.820	3.020	0.111	0.119
E	1.500	1.700	0.059	0.067
E1	2.650	2.950	0.104	0.116
e	0.950(BSC)		0.037(BSC)	
e1	1.800	2.000	0.071	0.079
L	0.300	0.600	0.012	0.024
θ	0°	8°	0°	8°

## Packaging Information

### SOT89-3L

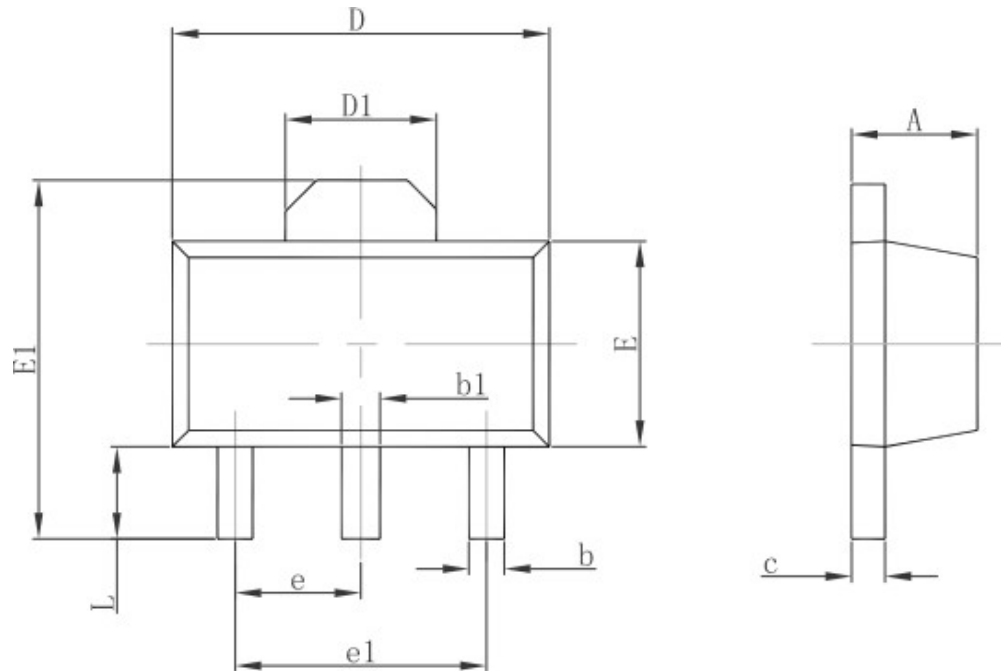

Symbol	Dimensions In Millimeters		Dimensions In Inches	
	Min.	Max.	Min.	Max.
A	1.400	1.600	0.055	0.063
b	0.320	0.520	0.013	0.020
b1	0.400	0.580	0.016	0.023
c	0.350	0.440	0.014	0.017
D	4.400	4.600	0.173	0.181
D1	1.550 REF.		0.061 REF.	
E	2.300	2.600	0.091	0.102
E1	3.940	4.250	0.155	0.167
e	1.500 TYP.		0.060 TYP.	
e1	3.000 TYP.		0.118 TYP.	
L	0.900	1.200	0.035	0.047

## Packaging Information

### DFN1x1-4L

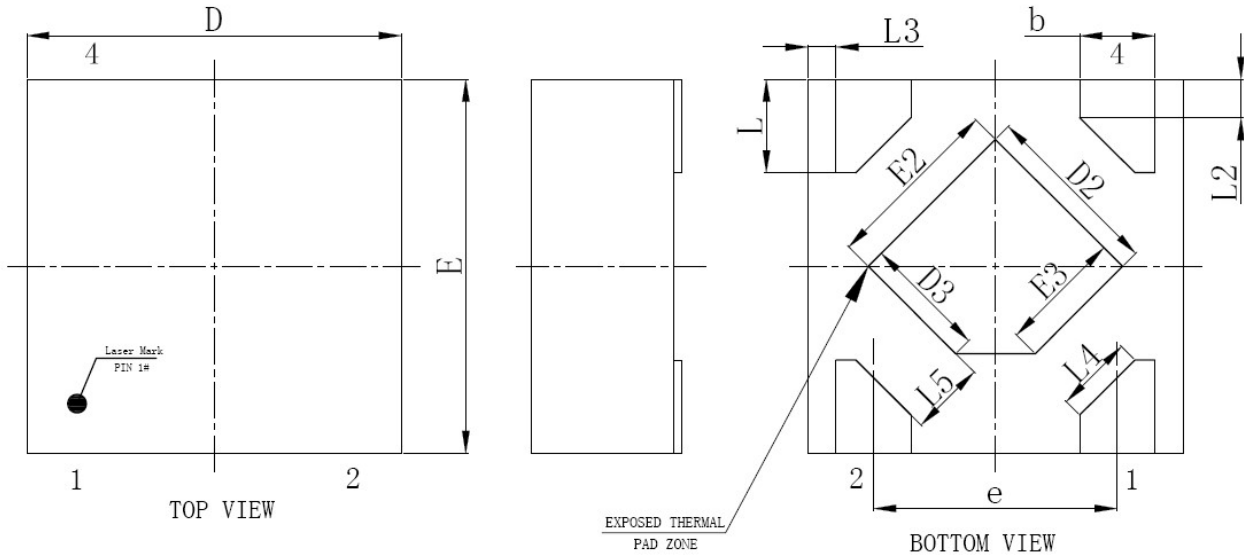

SYMBOL	MILLIMETER		
	MIN	NOM	MAX
A	0.35	-	0.40
A1	0.00	0.02	0.05
b	0.15	0.20	0.25
c	0.127REF		
D	0.95	1.00	1.05
D2	0.38	0.48	0.58
D3	0.23	0.33	0.43
e	0.65BSC		
E	0.95	1.00	1.05
E2	0.38	0.48	0.58
E3	0.23	0.33	0.43
L	0.20	0.25	0.30
L2	0.103REF		
L3	0.075REF		
L4	0.208REF		
L5	0.200REF		

## Packaging Information

### DFN2x2-3L

Back view

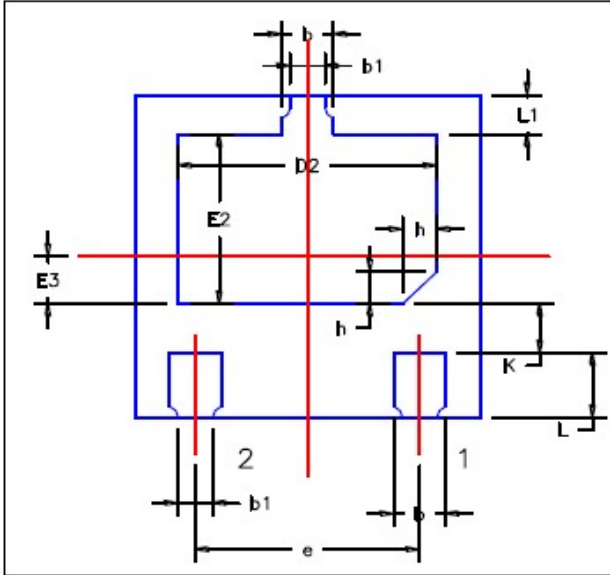

Soldering Pattern

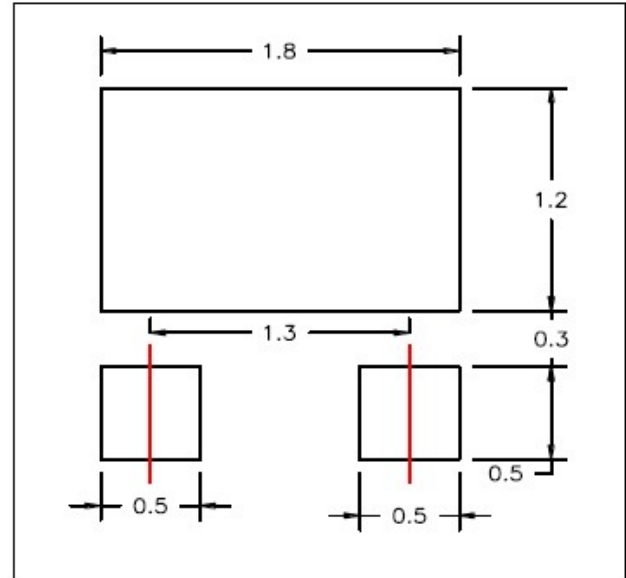

Top view

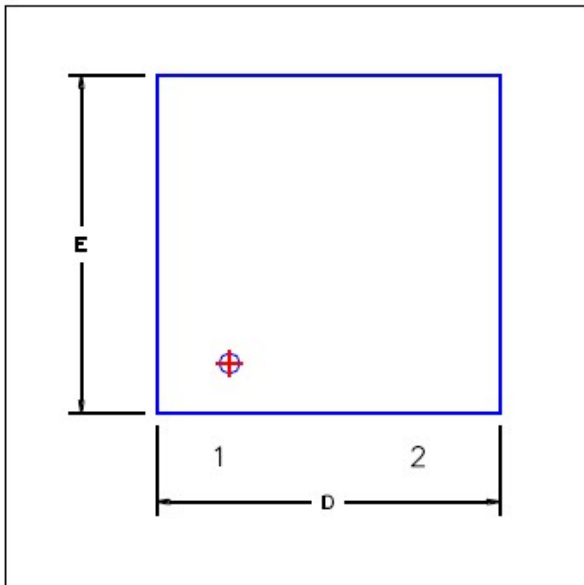

Side view

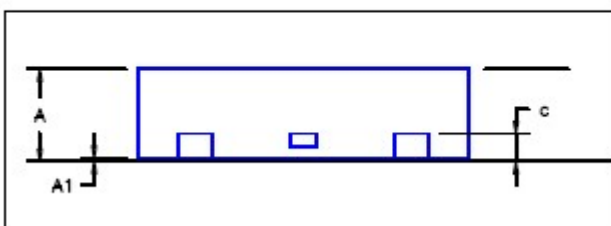

SYMBOL	MILLIMETER		
	MIN	NOM	MAX
A	0.50	0.55	0.60
A1	0.00	0.02	0.05
b	0.25	0.30	0.35
b1	0.20 REF.		
c	0.152 REF.		
D	1.90	2.00	2.10
D2	1.40	1.50	1.60
e	1.30BSC		
E	1.90	2.00	2.10
E2	0.95	1.05	1.15
L	0.35	0.40	0.45
L1	0.20	0.25	0.30
h	0.20 REF.		
K	0.20	0.30	0.40

## Packaging Information

### SOT23-5L

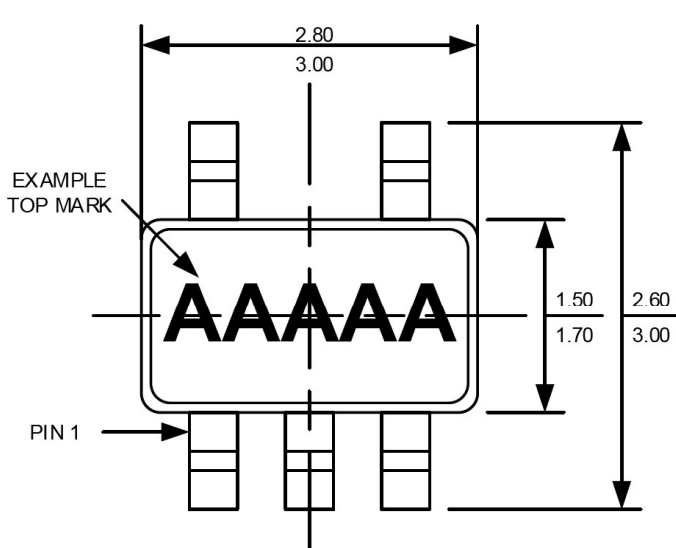

**TOP VIEW**

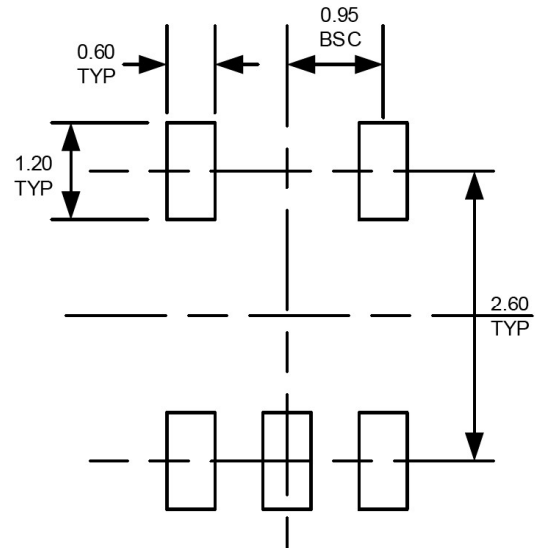

**RECOMMENDED PAD LAYOUT**

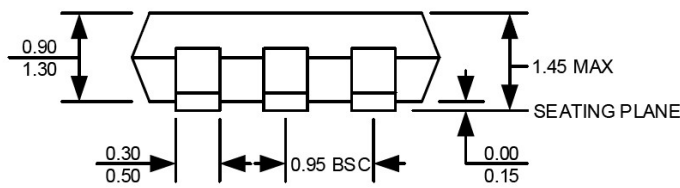

**FRONT VIEW**

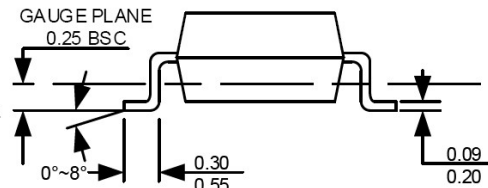

**SIDE VIEW**

Note:

1. All dimensions are in millimeters.
2. Package length does not include mold flash, protrusion or gate burr.
3. Package width does not include flash or protrusion.
4. Lead coplanarity (bottom of leads after forming) shall be 0.10 millimeters max.
5. Pin 1 is lower left pin when reading top mark from left to right.

## X-ON Electronics

Largest Supplier of Electrical and Electronic Components

*Click to view similar products for [Linear Voltage Regulators](#) category:*

*Click to view products by [WPMtek](#) manufacturer:*

Other Similar products are found below :

[LV5684PVD-XH](#) [MCDTSA6-2R](#) [L7815ACV-DG](#) [LV56801P-E](#) [UA7805CKC](#) [714954EB](#) [ZMR500QFTA](#) [BA033LBSG2-TR](#)  
[NCV78M05ABDTRKG](#) [LV5680P-E](#) [L79M05T-E](#) [L78LR05D-MA-E](#) [NCV317MBTG](#) [NTE7227](#) [MP2018GZD-33-P](#) [MP2018GZD-5-P](#)  
[LV5680NPVC-XH](#) [ZTS6538SE](#) [UA78L09CLP](#) [UA78L09CLPR](#) [CAT6221-PPTD-GT3](#) [MC78M09CDTRK](#) [NCV51190MNTAG](#)  
[BL1118CS8TR1833](#) [BL8563CKETR18](#) [BL8077CKETR33](#) [BL9153-33CC3TR](#) [BL9161G-15BADRN](#) [BL9161G-28BADRN](#)  
[BRCO7530MMC](#) [CJ7815B-TFN-ARG](#) [LM317C](#) [GM7333K](#) [GM7350K](#) [XC6206P332MR](#) [HT7533](#) [LM7912S/TR](#) [LT1764S/TR](#) [LM7805T](#)  
[LM338T](#) [LM1117IMP-3.3/TR](#) [HT1117AM-3.3](#) [HT7550S](#) [AMS1117-3.3](#) [HT7150S](#) [78L12](#) [HT7550](#) [HT7533-1](#) [HXY6206I-2.5](#) [HT7133](#)