

Features

- 650V Super-junction MOSFET
- Ultra fast body diode: $t_{rr}=202\text{ns}(\text{typ.})$
- Low drain-source On-resistance: $R_{DS(\text{on})}=0.099\Omega$ (Max.)
- 100% avalanche tested
- RoHS compliant device

Ordering Information

Part Number	Marking	Package
WTM40N65AMP	40N65AMP	TO-247

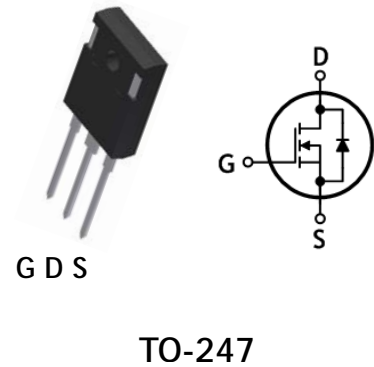

Marking Information

Absolute maximum ratings ($T_c=25^\circ\text{C}$ unless otherwise noted)

Characteristic	Symbol	Rating	Unit	
Drain-source voltage	V_{DSS}	650	V	
Gate-source voltage	V_{GSS}	± 30	V	
Drain current (DC) ^(Note 1)	I_D	$T_c=25^\circ\text{C}$	40	A
		$T_c=100^\circ\text{C}$	25	A
Drain current (Pulsed) ^(Note 1)	I_{DM}	160	A	
Single pulsed avalanche energy ^(Note 2)	E_{AS}	470	mJ	
Repetitive avalanche current ^(Note 1)	I_{AR}	9	A	
Repetitive avalanche energy ^(Note 1)	E_{AR}	2.3	mJ	
Power dissipation	P_D	230	W	
Diode dv/dt ruggedness ^(Note 3)	dv/dt	50	V/ns	
MOSFET dv/dt ruggedness ^(Note 4)	dv/dt	50	V/ns	
Junction temperature	T_J	150	$^\circ\text{C}$	
Storage temperature range	T_{stg}	-55-150	$^\circ\text{C}$	

Thermal Characteristics

Characteristic	Symbol	Rating	Unit
Thermal resistance, junction to case	$R_{th(j-c)}$	Max. 0.543	°C/W
Thermal resistance, junction to ambient	$R_{th(j-a)}$	Max. 50	

Electrical Characteristics ($T_C=25^\circ\text{C}$ unless otherwise noted)

Characteristic	Symbol	Test Condition	Min.	Typ.	Max.	Unit
Drain-source breakdown voltage	BV_{DSS}	$I_D=250\mu\text{A}$, $V_{GS}=0$	650	-	-	V
Gate threshold voltage	$V_{GS(th)}$	$I_D=250\mu\text{A}$, $V_{DS}=V_{GS}$	3	4	5	V
Drain-source cut-off current	I_{DSS}	$V_{DS}=650\text{V}$, $V_{GS}=0\text{V}$	-	-	10	μA
Gate leakage current	I_{GSS}	$V_{DS}=0\text{V}$, $V_{GS}=\pm 30\text{V}$	-	-	1000	nA
Drain-source on-resistance	$R_{DS(ON)}$	$V_{GS}=10\text{V}$, $I_D=15.4\text{A}$	-	0.081	0.099	Ω
Internal gate resistance	R_g	$F=1\text{MHz}$, open drain	-	10	-	Ω
Input capacitance	C_{iss}	$V_{DS}=100\text{V}$, $V_{GS}=0\text{V}$, $f=1\text{MHz}$	-	3596	-	pF
Output capacitance	C_{oss}		-	122	-	
Reverse transfer capacitance	C_{rss}		-	3.7	-	
Turn-on delay time (Note 5)	$t_{d(on)}$	$V_{DS}=400\text{V}$, $I_D=15.4\text{A}$, $R_G=10\Omega$	-	120	-	ns
Rise time (Note 5)	t_r		-	80	-	
Turn-off delay time (Note 5)	$t_{d(off)}$		-	165	-	
Fall time (Note 5)	t_f		-	8.5	-	
Total gate charge (Note 6)	Q_g	$V_{DS}=400\text{V}$, $V_{GS}=10\text{V}$, $I_D=30.8\text{A}$	-	74	-	nC
Gate-source charge (Note 6)	Q_{gs}		-	26.5	-	
Gate-drain charge (Note 6)	Q_{gd}		-	27.5	-	
Gate plateau voltage (Note 6)	$V_{plateau}$		-	7.2	-	

Source-Drain Diode Ratings and Characteristics ($T_C=25^\circ\text{C}$ unless otherwise noted)

Characteristic	Symbol	Test Condition	Min.	Typ.	Max.	Unit
Source current (DC)	I_S	Integral reverse diode in the MOSFET	-	-	40	A
Source current (Pulsed)	I_{SM}		-	-	160	A
Forward voltage	V_{SD}	$V_{GS}=0\text{V}$, $I_S=30.8\text{A}$	-	-	1.5	V
Reverse recovery time (Note 5, 6)	t_{rr}	$I_S=15.4\text{A}$, $V_{GS}=0\text{V}$, $di_S/dt=100\text{A}/\mu\text{s}$	-	200	-	ns
Reverse recovery charge (Note 5, 6)	Q_{rr}		-	0.51	-	μC

Note:

1. Calculated continuous current based on maximum allowable junction temperature
2. $L=10\text{mH}$, $I_{AS}=9\text{A}$, $V_{DD}=90\text{V}$, Starting $T_J=25^\circ\text{C}$
3. $I_S \leq 9\text{A}$, $V_{DS} \leq 400\text{V}$, $di_S/dt \leq 100\text{A}/\mu\text{s}$, $T_J=25^\circ\text{C}$
4. $V_{DS} \leq 400\text{V}$, $T_J=25^\circ\text{C}$
5. Guaranteed by design, not subject to production testing
6. Pulse test: Pulse width $\leq 300\mu\text{s}$, Duty cycle $\leq 2\%$

Typical Electrical Characteristics Curves

Fig. 1 Typical Output Characteristics

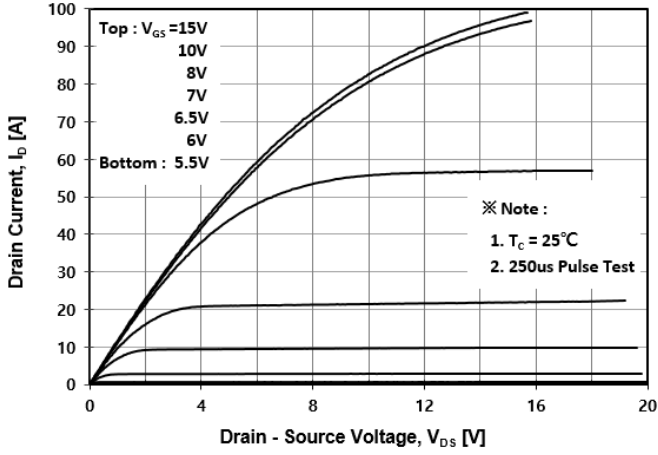

Fig. 2 Typical Transfer Characteristics

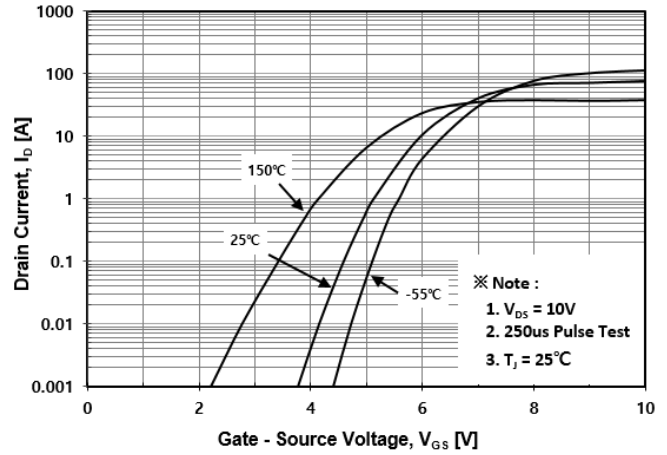

Fig.3 On-Resistance Variation with Drain Current and Gate Voltage

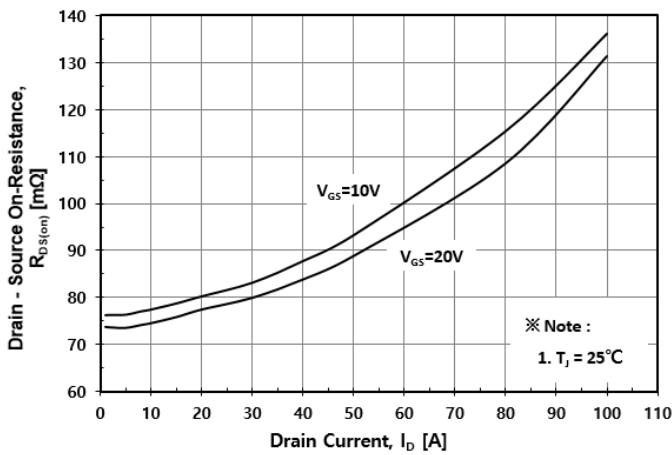

Fig. 4 Body Diode Forward Voltage Variation with Source Current

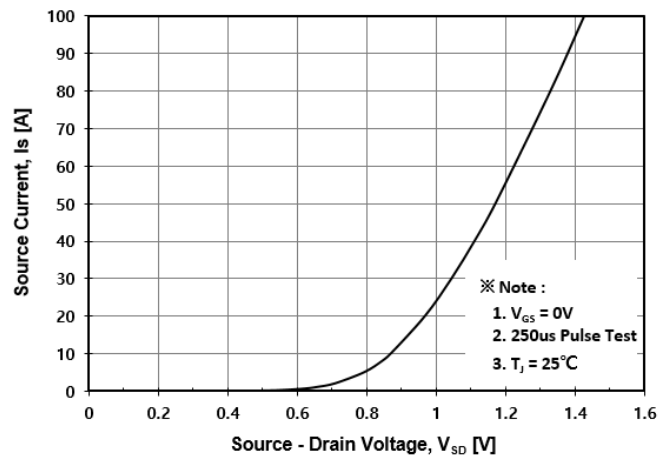

Fig. 5 Typical Capacitance Characteristics

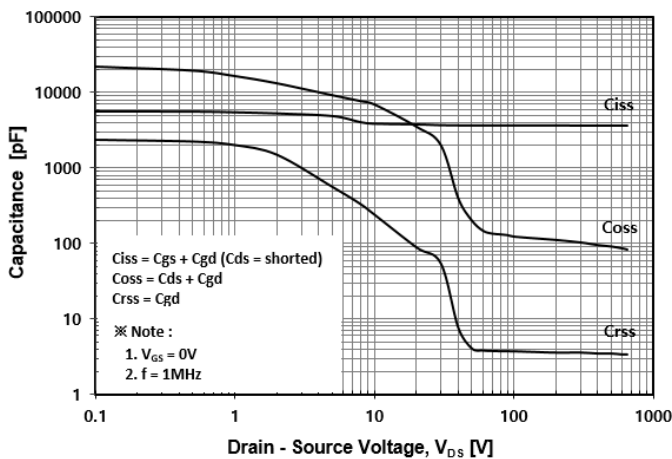

Fig. 6 Typical Total Gate Charge Characteristics

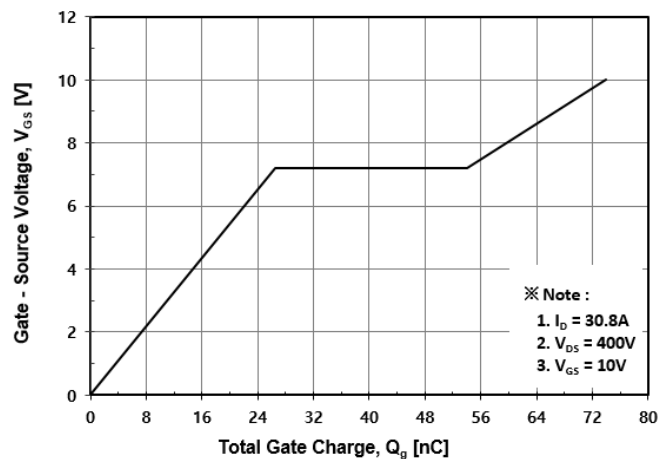

Fig. 7 Breakdown Voltage Variation vs. Temperature

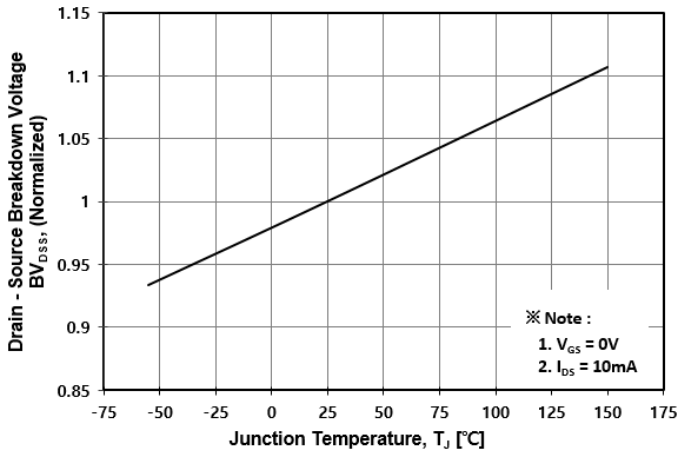

Fig. 8 On-Resistance Variation vs. Temperature

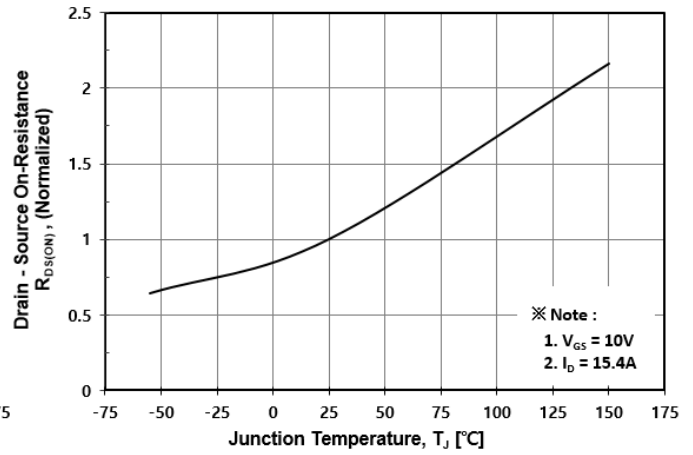

Fig. 9 Maximum Drain Current vs. Case Temperature

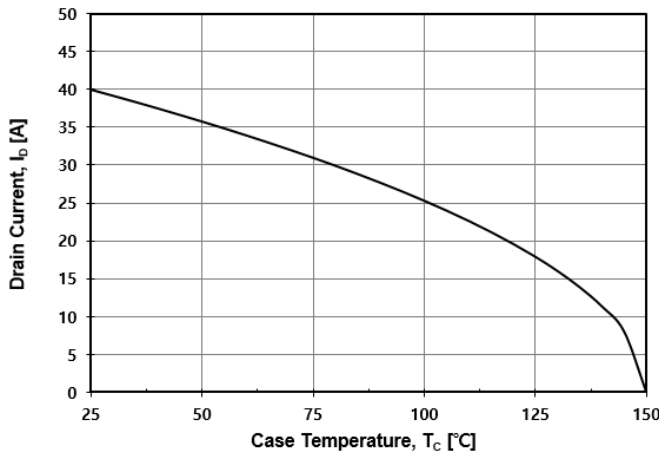

Fig. 10 Maximum Safe Operating Area

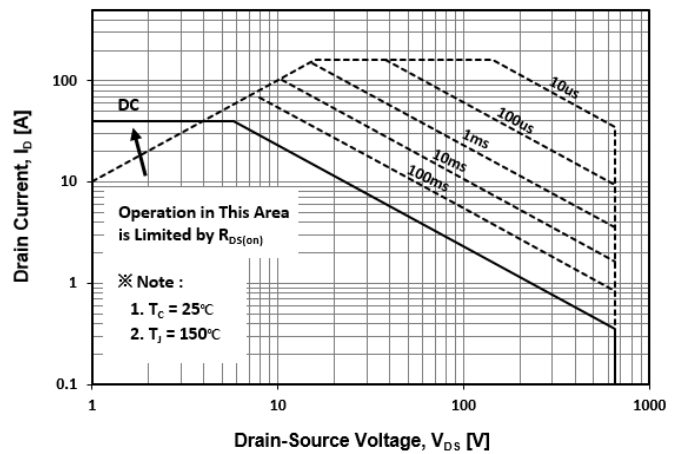

Fig. 11 Transient Thermal Impedance

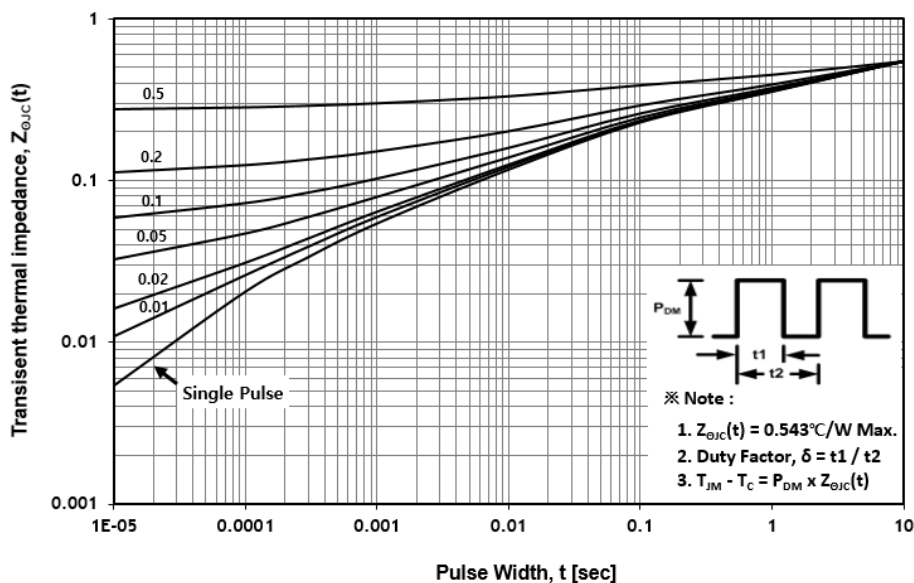

Fig. 12 Gate Charge Test Circuit & Waveform

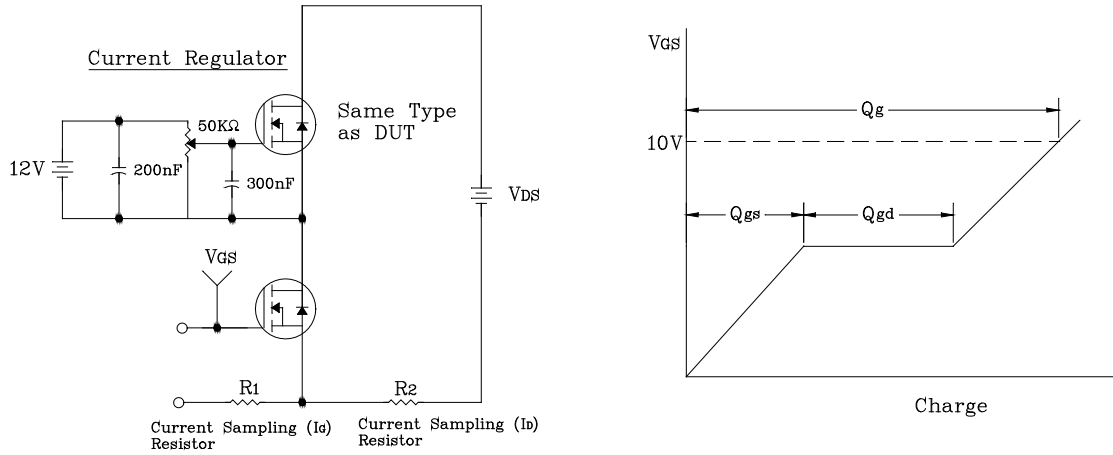

Fig. 13 Resistive Switching Test Circuit & Waveform

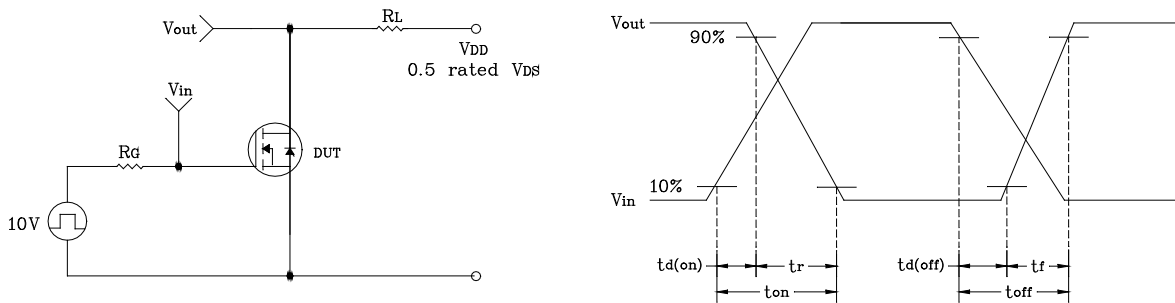

Fig. 14 E_{AS} Test Circuit & Waveform

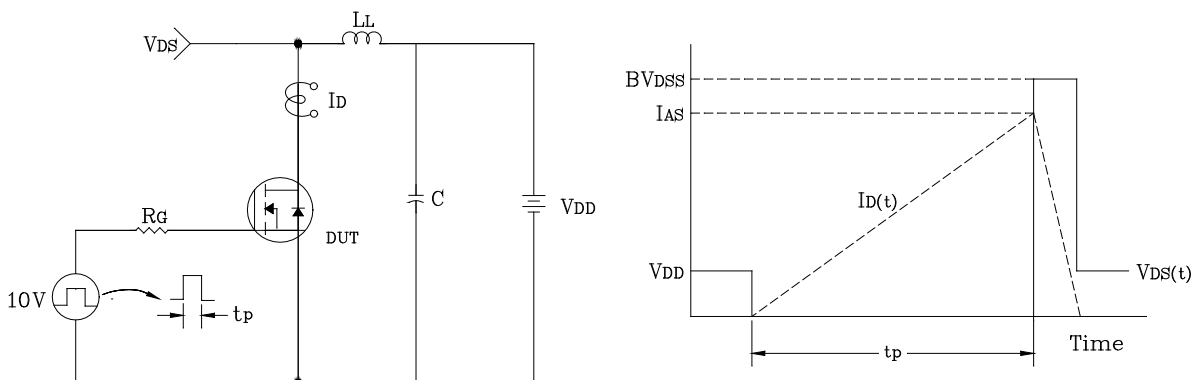
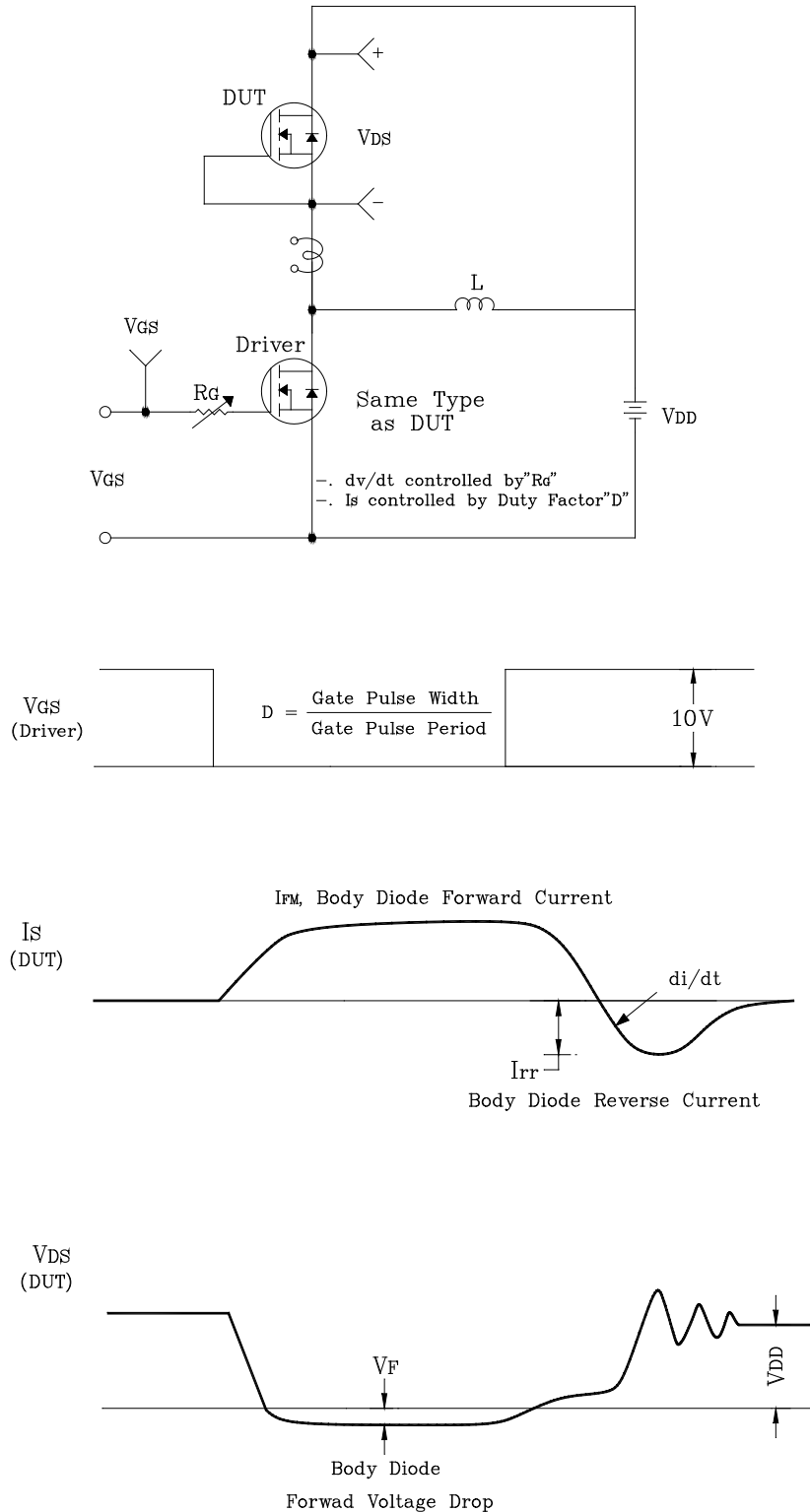
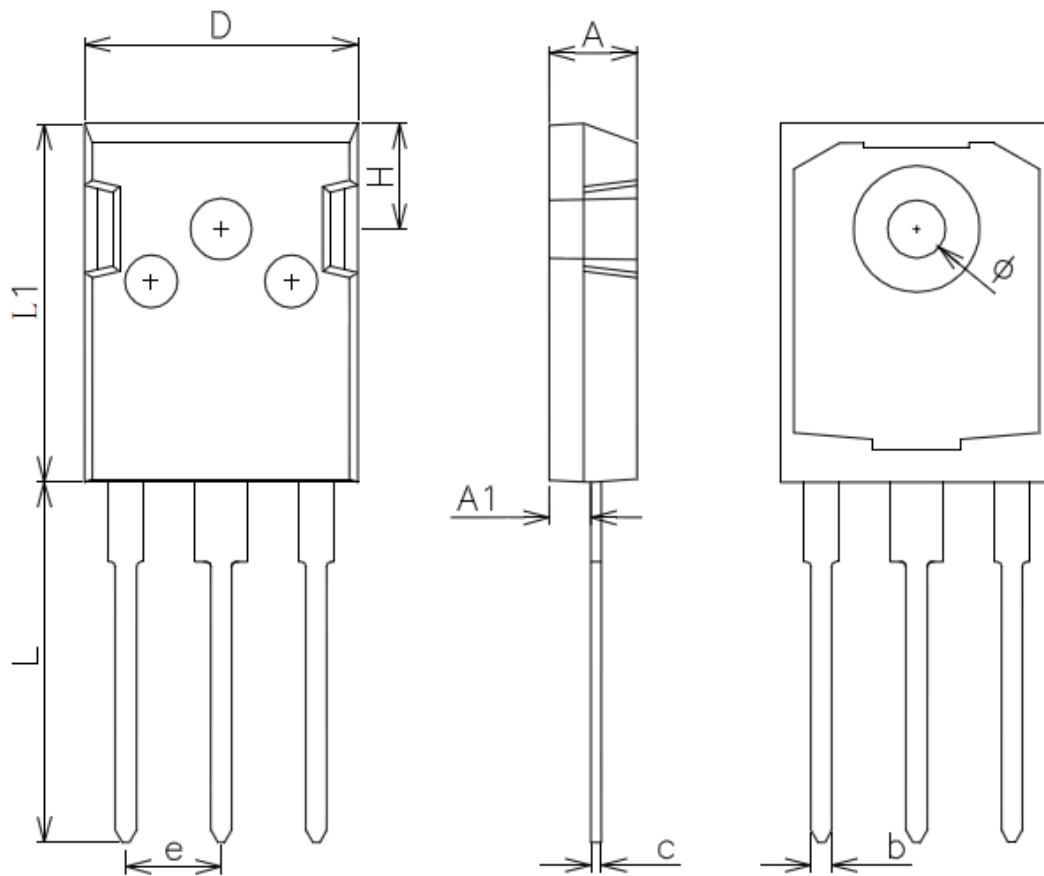

Fig. 15 Diode Reverse Recovery Time Test Circuit & Waveform



Package Outline Dimensions



SYMBOL	MILLIMETERS		
	MIN	Nominal	MAX
A	4.80	5.00	5.20
A1	2.41 REF		
b	1.00	1.20	1.40
c	0.40	0.60	0.80
D	15.60	15.80	16.00
e	5.45 REF		
H	6.15 REF		
L	19.35	19.95	20.55
L1	20.80	21.00	21.20
ϕ	3.20	3.50	3.80

X-ON Electronics

Largest Supplier of Electrical and Electronic Components

Click to view similar products for [MOSFET](#) category:

Click to view products by [WPMtek](#) manufacturer:

Other Similar products are found below :

[IRFD120](#) [JANTX2N5237](#) [BUK455-60A/B](#) [MIC4420CM-TR](#) [VN1206L](#) [NDP4060](#) [SI4482DY](#) [IPS70R2K0CEAKMA1](#) [SQD23N06-31L-GE3](#)
[TK16J60W,S1VQ\(O](#) [2SK2614\(TE16L1,Q\)](#) [DMN1017UCP3-7](#) [DMN1053UCP4-7](#) [SQJ469EP-T1-GE3](#) [NTE2384](#) [DMC2700UDMQ-7](#)
[DMN2080UCB4-7](#) [DMN61D9UWQ-13](#) [US6M2GTR](#) [DMN31D5UDJ-7](#) [DMP22D4UFO-7B](#) [DMN1006UCA6-7](#) [DMN16M9UCA6-7](#)
[STF5N65M6](#) [IRF40H233XTMA1](#) [STU5N65M6](#) [DMN6022SSD-13](#) [DMN13M9UCA6-7](#) [DMTH10H4M6SPS-13](#) [DMN2990UFB-7B](#)
[IPB80P04P405ATMA2](#) [2N7002W-G](#) [MCAC30N06Y-TP](#) [MCQ7328-TP](#) [NTMC083NP10M5L](#) [BXP7N65D](#) [BXP4N65F](#) [AOL1454G](#)
[WMJ80N60C4](#) [BXP2N20L](#) [BXP2N65D](#) [BXT1150N10J](#) [BXT1700P06M](#) [TSM60NB380CP](#) [ROG](#) [RQ7L055BGTGR](#) [DMNH15H110SK3-13](#)
[SLF10N65ABV2](#) [BSO203SP](#) [BSO211P](#) [IPA60R230P6](#)