

# Resistance Welded HC-49SMD

## 12.7×4.8×3.8 mm

### Feature

- Surface mount type crystal units.
- A great number of standard frequencies.
- Higher frequency available and lower equivalent series resistance.
- Lower cost and highly mass production capability.
- RoHS Compliant / Pb Free

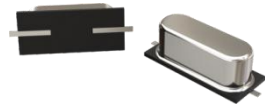

### Electrical Specifications

Item	Specifications		
Frequency Range(MHz)	16.000MHz		
Mode	AT/Fundamental	AT/3RD	AT/3RD
Load Capacitance (CL)	20pF		
Frequency Tolerance( at 25°C )	±30ppm		
Operating Temperature Range	-20~+70°C		
Frequency Stability Over Operating Temperature Range	±30ppm		
Equivalent Series Resistance (ESR) max.	30Ω		
Storage Temperature Range	-55~+125°C		
Shunt Capacitance( C <sub>0</sub> )	7.0 pF Max		
Drive Level (Typical)	1 μW~500 μW (100μW typical)		
Aging @25 °C 1st Year (Max)	±3 ppm/year or ±5 ppm/year		

### Dimension(mm)

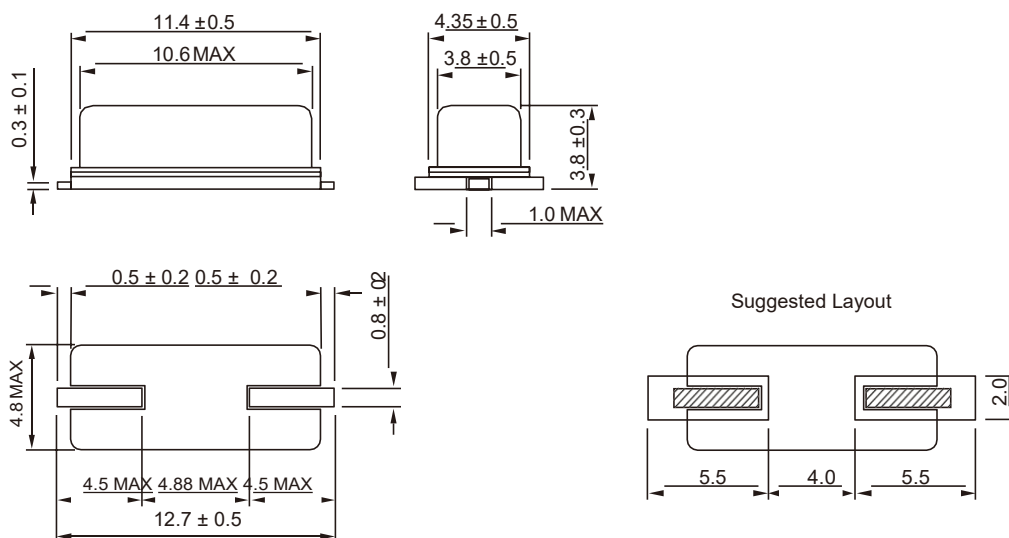

## X-ON Electronics

Largest Supplier of Electrical and Electronic Components

*Click to view similar products for [Crystals](#) category:*

*Click to view products by [WTL](#) manufacturer:*

Other Similar products are found below :

[CX3225GB25000M0PPSZ1](#) [718-13.2-1](#) [MC405 32.0000K-R3:PURE SN](#) [7A-40.000MAAE-T](#) [FL2000085](#) [99-BU](#) [9B-15.360MBBK-B](#) [9C-7.680MBBK-T](#) [H10S-12.000-18-EXT-TR](#) [ABC2-6.000MHZ-D4Z-T](#) [ABLS-20.000MHZ-D2-T](#) [ABS071-32.768KHZ-6-T](#) [R38-32.768-12.5-5PPM-NPB](#) [BTD1062E05A-513](#) [21U15A-21.4MHZ](#) [RTX-781DF1-S-20.950](#) [LFXTAL066198Cutt](#) [9C-14.31818MBBK-T](#) [A-11.000MHZ-27](#) [ABL-27.000MHZ-B4Y-T](#) [ABM11-132-24.000MHZ-T3](#) [ABM3B1-25.000MHZ-D2Y-T](#) [SPT2A-.032768B](#) [SPT2A.032768G](#) [SSPT7F-9PF20-R](#) [FX325BS-38.88EEM1201](#) [LFXTAL065253Cutt](#) [LFXTAL066431Cutt](#) [XT9S20ANA14M7456](#) [XT9SNLANA16M](#) [646G-24-2](#) [7A-24.576MBBK-T](#) [7B-30.000MBBK-T](#) [7A-14.31818MBBK-T](#) [6504-202-1501](#) [6526-202-1501](#) [ABLS-12.000MHZ-B2Y-T](#) [7A-10.000MBBK-T](#) [SG636PCE-20.000MC](#) [3404](#) [E1SAA18-25.000M TR](#) [CM315D32768EZFT](#) [C1E-24.000-7-2020-R](#) [C1E-19.200-12-1530-X-R](#) [C1E-16.000-12-1530-X-R](#) [ABM11-16.000MHZ-9-B1U-T](#) [FL5000014](#) [EUCA18-3.1872M](#) [FX0800015](#) [425F35E027M0000](#)