

Maximum Input 36V / 500mA / Fixed Output 3.3V, 5V, 12V or 15V
DESCRIPTION

The FDSM series of the MagI³C Power Module family is a fixed output voltage, fully integrated DC-DC power supply including the controller IC, inductor and capacitors all in one package.

For optimal performance the module is recommended for use with external input and output capacitors as well as a an input filter.

The FDSM ensures fast time to market and low development costs.

It is pin compatible with the common 78xx linear regulator series. The high efficiency reduces the power dissipation and in many cases a heatsink and assembly parts are unnecessary.

24V to 3.3V conversion achieves up to 83% efficiency. 24V to 5V conversion achieves up to 88% efficiency. 24V to 12V conversion achieves up to 94% efficiency. 24V to 15V conversion achieves up to 96% efficiency.

The standard THT (10.16 x 11.6 x 7.55mm) package allows for easy assembly.

TYPICAL APPLICATIONS

- Point-of-Load DC-DC applications
- Replacement for linear regulators
- Interface and microcontroller supplies
- General purpose

FEATURES

- Peak efficiency up to 97%
- Current capability up to 500mA
- Input voltage up to 36V
- Minimum inpput voltage / output voltage:
4.75 Vin / 3.3 Vout (173950336)
6.5 Vin / 5 Vout (173950536)
15 Vin / 12 Vout (173951236)
19 Vin / 15 Vout (173951536)
- Output voltage accuracy: $\pm 4\%$ max
- No minimum load required
- Partially integrated input and output capacitors
- Integrated inductor
- Low output voltage ripple (<45mV_{pp} typ.)
- Fixed 710kHz (typ.) switching frequency
- Current mode control
- Pulse skipping for high efficiency at light loads
- Internal soft-start
- Short circuit protection
- Cycle by cycle current limit
- Pin compatible with the FDSM power module series
- Operating ambient temperature range: -40°C to 85°C
- RoHS & REACH compliant
- Case and potting material UL 94 Class V0 (flammability testing) certified
- Complies with EN55032 class B conducted and radiated emissions standard

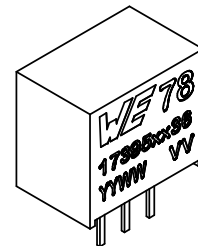
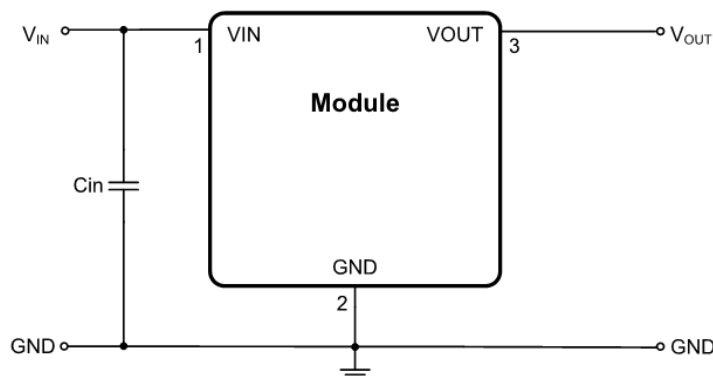
TYPICAL CIRCUIT DIAGRAM

PINOUT

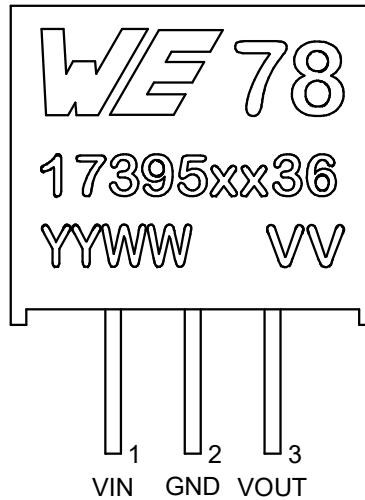

MARKING DESCRIPTION

MARKING	DESCRIPTION
WE	Würth Elektronik eiSos GmbH & Co. KG
78	Indicates compatibility with 78xx linear regulator
17395xx36	Order code
YY	Year
WW	Calendar week
VV	Output voltage (3.3V, 5V, 12V or 15V)

PIN DESCRIPTION

SYMBOL	NUMBER	TYPE	DESCRIPTION
VIN	1	Power	The supply input pin is a terminal for an input voltage source. It is recommended to use a 10 μ F/50V input capacitor.
GND	2	Power	Ground pin; reference for V _{IN} and V _{OUT} .
VOUT	3	Power	Regulated output voltage pin. There is no need for an external output capacitor.

17395xx36

MagI³C Power Module

WPME-FDSM - Fixed Step Down Regulator Module



**WÜRTH
ELEKTRONIK**
MORE THAN
YOU EXPECT

ORDERING INFORMATION

ORDER CODE	SPECIFICATIONS	PACKAGE	PACKAGING UNIT
173950336	36V / 500mA / 3.3Vout version	SIP-3	Tube with 43 pieces
173950536	36V / 500mA / 5Vout version		
173951236	36V / 500mA / 12Vout version		
173951536	36V / 500mA / 15Vout version		
17800FDSM	Evaluation board		

SALES INFORMATION

SALES CONTACT
Würth Elektronik eiSos GmbH & Co. KG EMC and Inductive Solutions Max-Eyth-Str. 1 74638 Waldenburg Germany Tel. +49 (0) 7942 945 0 www.we-online.com/powermodules Technical support: powermodules@we-online.com

PIN COMPATIBLE FAMILY MEMBERS

ORDER CODE	SPECIFICATIONS	PACKAGE	PACKAGING UNIT
173950378	28V / 500mA / 3.3Vout	SIP-3	Tube with 42 pieces
173950578	28V / 500mA / 5Vout		
173010378	28V / 1A / 3.3Vout		
173010578	28V / 1A / 5Vout		
173010342	42V / 1A / 3.3Vout		
173010542	42V / 1A / 5Vout		
173950336	36V / 500mA / 3.3Vout		Tube with 43 pieces
173950536	36V / 500mA / 5Vout		
173951236	36V / 500mA / 12Vout		
173951536	36V / 500mA / 15Vout		
173010335	36V / 1A / 3.3Vout		
173010535	36V / 1A / 5Vout		
173011235	36V / 1A / 12Vout		
173011535	36V / 1A / 15Vout		

ABSOLUTE MAXIMUM RATINGS

Caution:

Exceeding the listed absolute maximum ratings may affect the device negatively and may cause permanent damage.

SYMBOL	PARAMETER	LIMIT		UNIT
		MIN ⁽¹⁾	MAX ⁽¹⁾	
V _{IN}	Input pin voltage	-0.3	44	V
V _{OUT}	Output pin voltage	-0.3	25	V
T _{storage}	Assembled, non-operating storage temperature	-40	125	°C
V _{esd}	ESD Voltage (Human Body Model), according to EN61000-R-2 ⁽²⁾	-4	4	kV

OPERATING CONDITIONS

Operating conditions are conditions under which the device is intended to be functional. All values are referenced to GND.

MIN and MAX limits are valid for the recommended ambient temperature range of **-40 °C to 85 °C**. Typical values represent statistically the utmost probable values at the following conditions: V_{IN}= 4.75V to 36V (173950336), V_{IN}= 6.5V to 36V (173950536), V_{IN}= 15V to 36V (173951236), V_{IN}= 19V to 36V (173951536), I_{OUT}= 500mA, T_A = 25 °C, unless otherwise noted.

SYMBOL	PARAMETER	MIN ⁽¹⁾	TYP ⁽³⁾	MAX ⁽¹⁾	UNIT
V _{IN}	Input Voltage (173950336)	4.75	-	36	V
V _{IN}	Input Voltage (173950536)	6.5	-	36	V
V _{IN}	Input Voltage (173951236)	15	-	36	V
V _{IN}	Input Voltage (173951536)	19	-	36	V
T _a	Ambient temperature range	-40	-	85 ⁽⁴⁾	°C
I _{OUT}	Nominal output current	-	-	500	mA
C _{OUT MAX}	Maximal output capacitance	-	-	680	µF

ELECTRICAL SPECIFICATIONS

MIN and MAX limits are valid for the recommended ambient temperature range of **-40°C to 85°C**. Typical values represent statistically the utmost probable values at the following conditions: $V_{IN} = 24V$ (173950336, 173950536, 173951236 and 173951536), $I_{OUT} = 500mA$, $T_A = 25°C$, unless otherwise noted.

SYMBOL	PARAMETER	TEST CONDITIONS	LIMIT			UNIT	
			MIN ⁽¹⁾	TYP ⁽³⁾	MAX ⁽¹⁾		
Output Current							
I_{CL}	Current limit threshold	$V_{IN} = 24V$	-	1.5	-	A	
Output Voltage							
V_{OUT}	Regulated output voltage	173950336	-	3.3	-	V	
		173950536	-	5	-	V	
		173951236	-	12	-	V	
		173951536	-	15	-	V	
	Line regulation	$I_{OUT} = 500mA$	-0.4	± 0.2	0.4	%	
	Load Regulation	10% to 100% load	-	± 0.6	-	%	
	Total output voltage regulation	Full load, full input voltage range	-4	± 2	4	%	
	External 2x $C_{OUT} = 10\mu F, 25V, X5R, 20MHz$ BWL						
	Output voltage ripple	$V_{OUT} = 3.3V$ $I_{OUT} = 500mA$	-	6	-	mV _{pp}	
		$V_{OUT} = 5V$ $I_{OUT} = 500mA$	-	5	-	mV _{pp}	
$V_{OUT} = 12V$ $I_{OUT} = 500mA$		-	30	-	mV _{pp}		
$V_{OUT} = 15V$ $I_{OUT} = 500mA$		-	40	-	mV _{pp}		
Switching Frequency							
f_{SW}	Switching frequency	Continuous conduction mode (CCM)	-	710	-	kHz	
Input Current							
I_{IN}	No load input current	Operating, switching	-	0.1	1	mA	
Efficiency							
η	Efficiency, $I_{OUT} = 500mA$	$V_{IN} = 4.75V, V_{OUT} = 3.3V$	-	92	-	%	
		$V_{IN} = 24V, V_{OUT} = 3.3V$	-	81	-	%	
		$V_{IN} = 36V, V_{OUT} = 3.3V$	-	78	-	%	
		$V_{IN} = 6.5V, V_{OUT} = 5V$	-	95	-	%	
		$V_{IN} = 24V, V_{OUT} = 5V$	-	86	-	%	
		$V_{IN} = 36V, V_{OUT} = 5V$	-	84	-	%	
		$V_{IN} = 16V, V_{OUT} = 12V$	-	95	-	%	
		$V_{IN} = 24V, V_{OUT} = 12V$	-	94	-	%	
		$V_{IN} = 20V, V_{OUT} = 15V$	-	97	-	%	
$V_{IN} = 24V, V_{OUT} = 15V$	-	95	-	%			

RoHS, REACH

RoHS directive		Directive 2011/65/EU of the European Parliament and the Council of June 8th, 2011 on the restriction of the use of certain hazardous substances in electrical and electronic equipment.
REACH directive		Directive 1907/2006/EU of the European Parliament and the Council of June 1st, 2007 regarding the Registration, Evaluation, Authorization and Restriction of Chemicals (REACH).

RELIABILITY

SYMBOL	PARAMETER	TEST CONDITIONS	TYP ⁽³⁾	UNIT
MTBF	Mean time between failures	MIL-HDBK-217F, 25 °C	2000 · 10 ³	h

PACKAGE SPECIFICATIONS

ITEM	PARAMETER	TYP ⁽³⁾	UNIT
Case	Black flame-retardant and heat-resistant plastic (UL94 V-0)	-	-
Potting material	Silicone, UL94V-0	-	-
Weight		1.8	g
Vibration	5g for 20 min	MIL-STD-202, Method 204	

NOTES

- (1) Min and Max are 100% production tested at 25° C. Limits over the operating temperature range are guaranteed through correlation using Statistical Quality Control (SQC) methods.
- (2) The human body model is a 100pF capacitor discharged through a 1.5 kΩ resistor into each pin. Test method is per JESD-22-114.
- (3) Typical numbers are valid at 25° C ambient temperature and represent statistically the utmost probability assuming the Gaussian distribution.
- (4) Depending on load current, see derating diagram.

TYPICAL PERFORMANCE CURVES

If not otherwise specified, the following conditions apply: $V_{IN} = 24V$; $V_{OUT} = 3.3V$ (173950336), $V_{OUT} = 5V$ (173950536), $V_{OUT} = 12V$ (173951236), and $V_{OUT} = 15V$ (173951536); $I_{OUT} = 500mA$; $T_{AMB} = 25^{\circ}C$.

RADIATED AND CONDUCTED EMISSIONS EN55032 (CISPR-32) CLASS B COMPLIANT

The 173950336, 173950536, 173951236 and 173951536 power modules are tested with a standard EMC configuration (1m wire between the module and the load) to give more realistic information about implementation in an application. The test setup is based on CISPR16 with the limit values CISPR32.

Measured with module on a circuit board in a Fully Anechoic Room (FAR) at 3m antenna distance.

TEST SETUP

Input wire length:

- Radiated Emission: 160cm (80cm Horizontal + 80cm Vertical)
- Conducted Emission: 80cm

Output wire length:

- Long wire (with input filter): 1m

RADIATED AND CONDUCTED EMISSIONS - 173950336

Radiated Emissions 173950336 (3m Antenna Distance)

$V_{IN} = 24V$, $V_{OUT} = 5V$, $I_{LOAD} = 0.5A$ with input filter

C_F and $C_{IN} = 4 \times 4.7\mu F$ (885012209048), $L_F = 1\mu H$ (7447730), $C_{OUT} = 2 \times 10\mu F$ (885012208069)

Horizontal Vertical

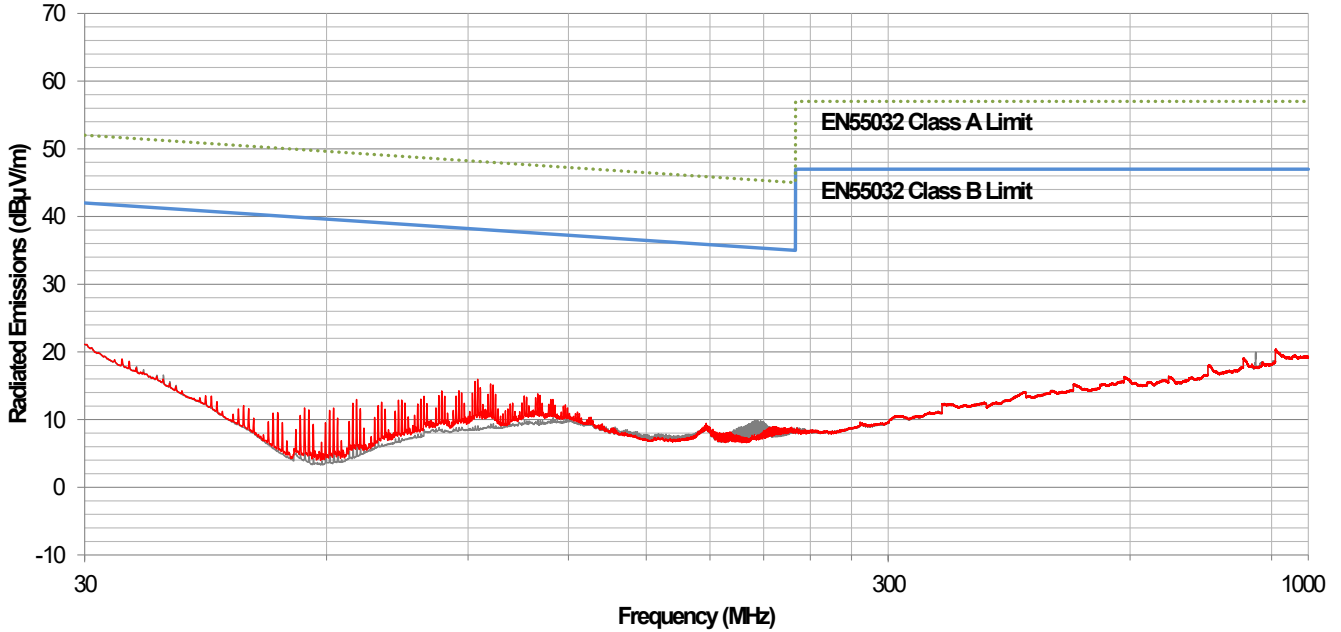

Conducted Emissions 173950336

$V_{IN} = 24V$, $V_{OUT} = 5V$, $I_{LOAD} = 0.5A$ with input filter

C_F and $C_{IN} = 4 \times 4.7\mu F$ (885012209048), $L_F = 1\mu H$ (7447730), $C_{OUT} = 2 \times 10\mu F$ (885012208069)

Average Quasi peak

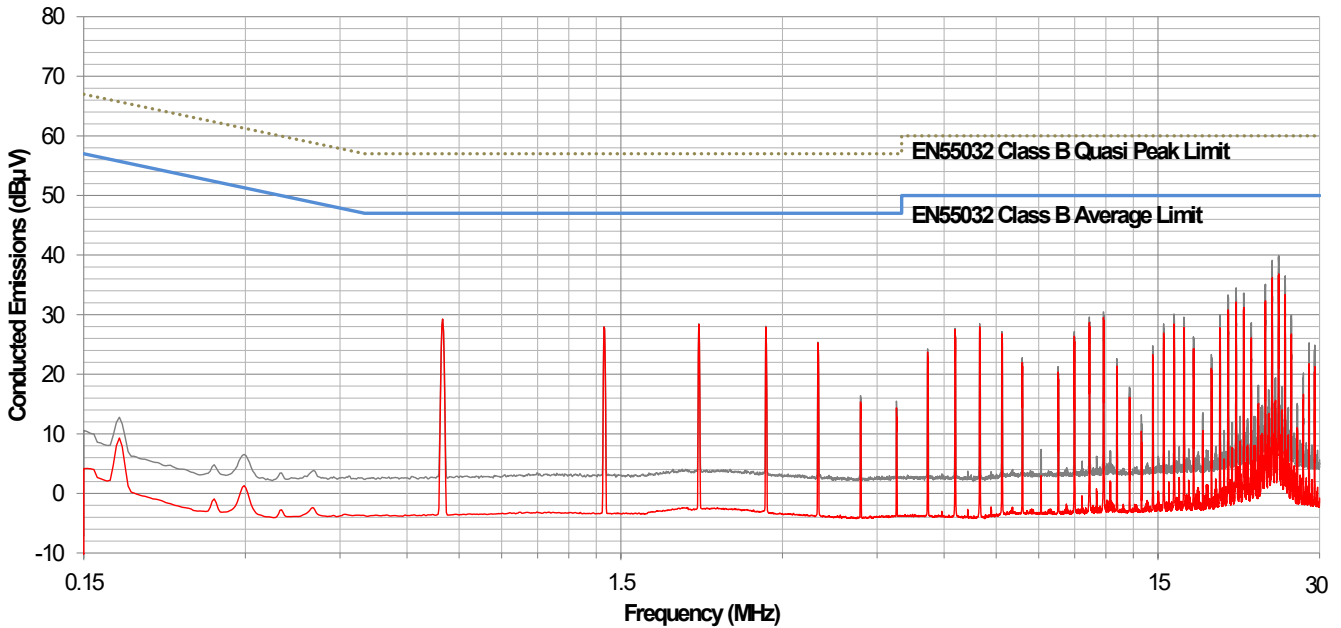

RADIATED AND CONDUCTED EMISSIONS - 173950536

Radiated Emissions 173950536 (3m Antenna Distance)

$V_{IN} = 24V$, $V_{OUT} = 5V$, $I_{LOAD} = 0.5A$ with input filter

C_F and $C_{IN} = 4 \times 4.7\mu F$ (885012209048), $L_F = 1\mu H$ (7447730), $C_{OUT} = 2 \times 10\mu F$ (885012208069)

Horizontal Vertical

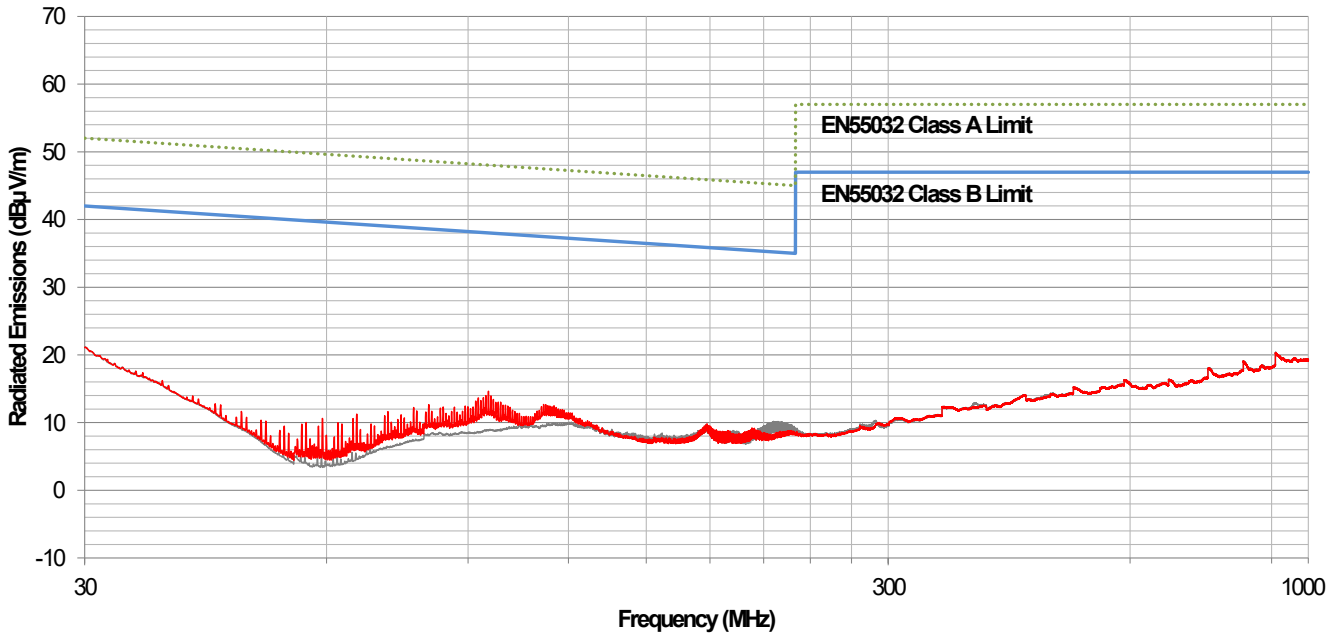

Conducted Emissions 173950536

$V_{IN} = 24V$, $V_{OUT} = 5V$, $I_{LOAD} = 0.5A$ with input filter

C_F and $C_{IN} = 4 \times 4.7\mu F$ (885012209048), $L_F = 1\mu H$ (7447730), $C_{OUT} = 2 \times 10\mu F$ (885012208069)

Average Quasi peak

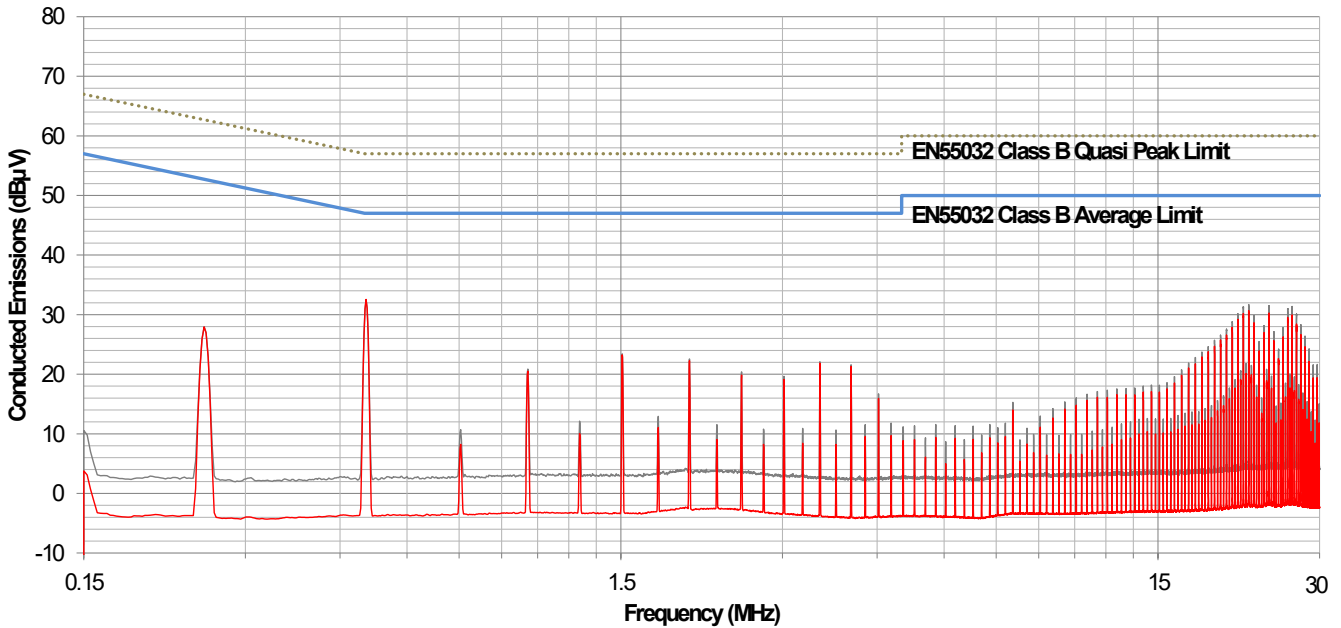

RADIATED AND CONDUCTED EMISSIONS - 173951236

Radiated Emissions 173951236 (3m Antenna Distance)

$V_{IN} = 24V$, $V_{OUT} = 12V$, $I_{LOAD} = 500mA$ with input filter

C_F and $C_{IN} = 4 \times 4.7\mu F$ (885012209048), $L_F = 1\mu H$ (7447730)

Horizontal Vertical

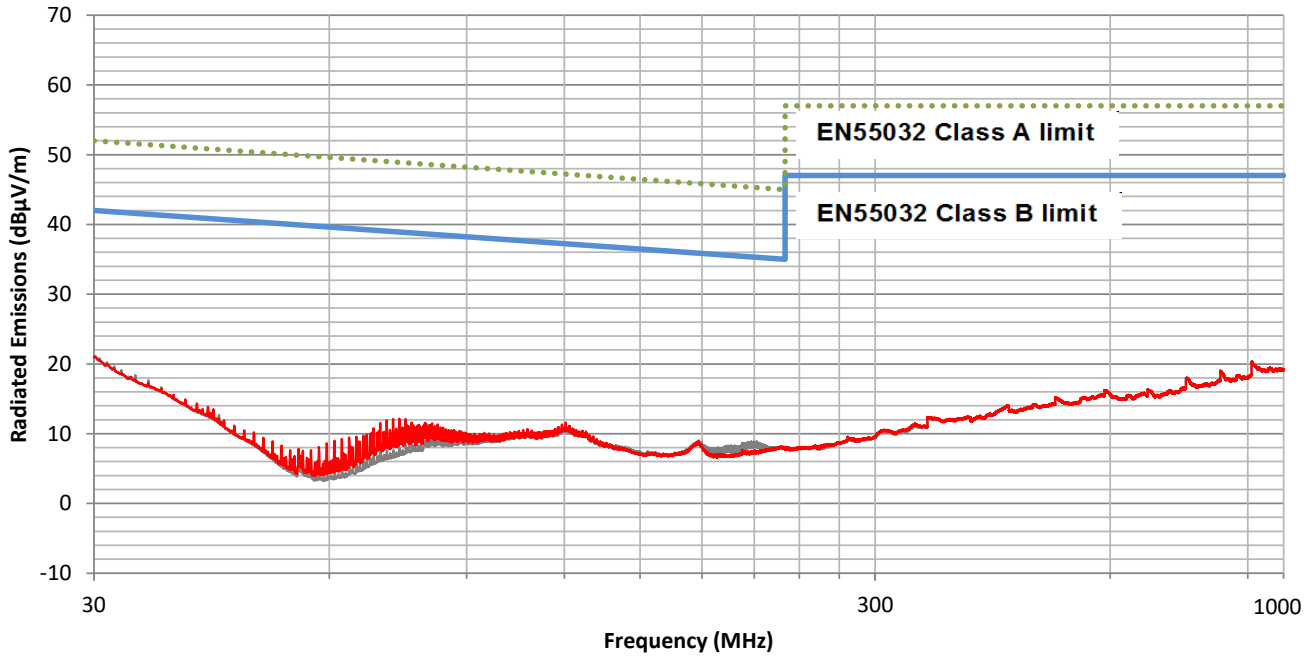

Conducted Emissions 173951236

$V_{IN} = 24V$, $V_{OUT} = 12V$, $I_{LOAD} = 500mA$ with input filter

C_F and $C_{IN} = 4 \times 4.7\mu F$ (885012209048), $L_F = 1\mu H$ (7447730)

Average Quasi peak

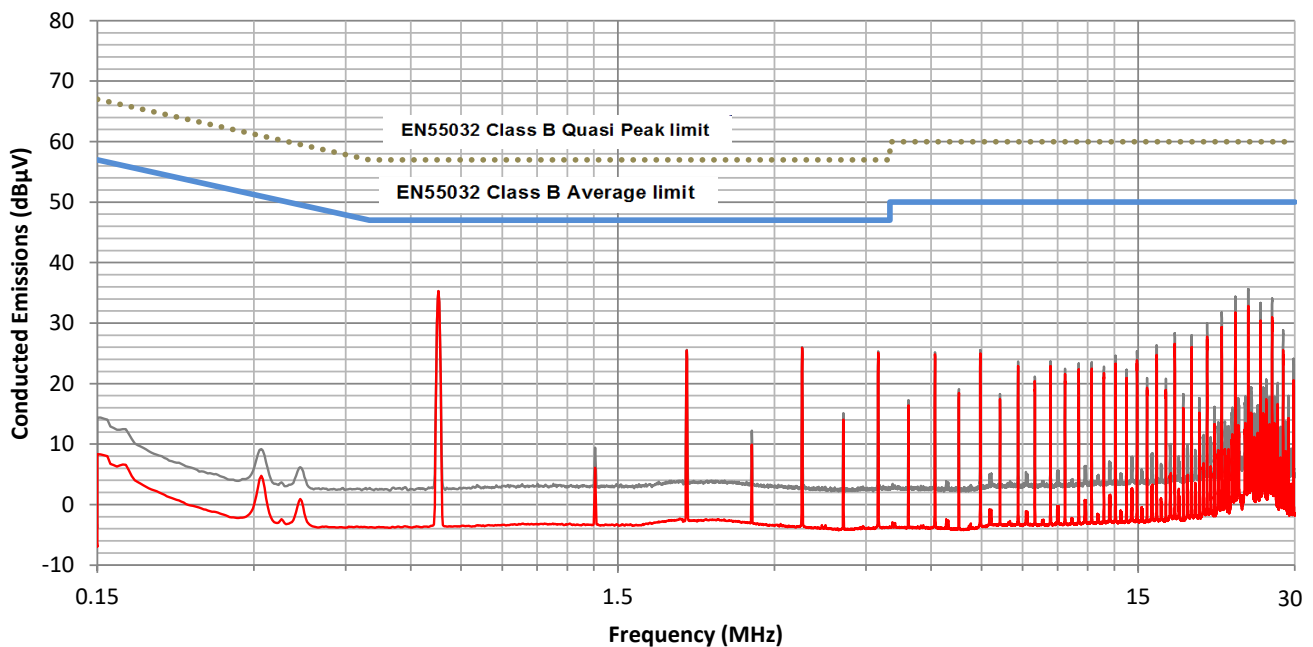

RADIATED AND CONDUCTED EMISSIONS - 173951536

Radiated Emissions 173951536 (3m Antenna Distance)
 $V_{IN} = 24V, V_{OUT} = 15V, I_{LOAD} = 500mA$ with input filter
 C_F and $C_{IN} = 4 \times 4.7\mu F$ (885012209048), $L_F = 1\mu H$ (7447730)
 Horizontal Vertical

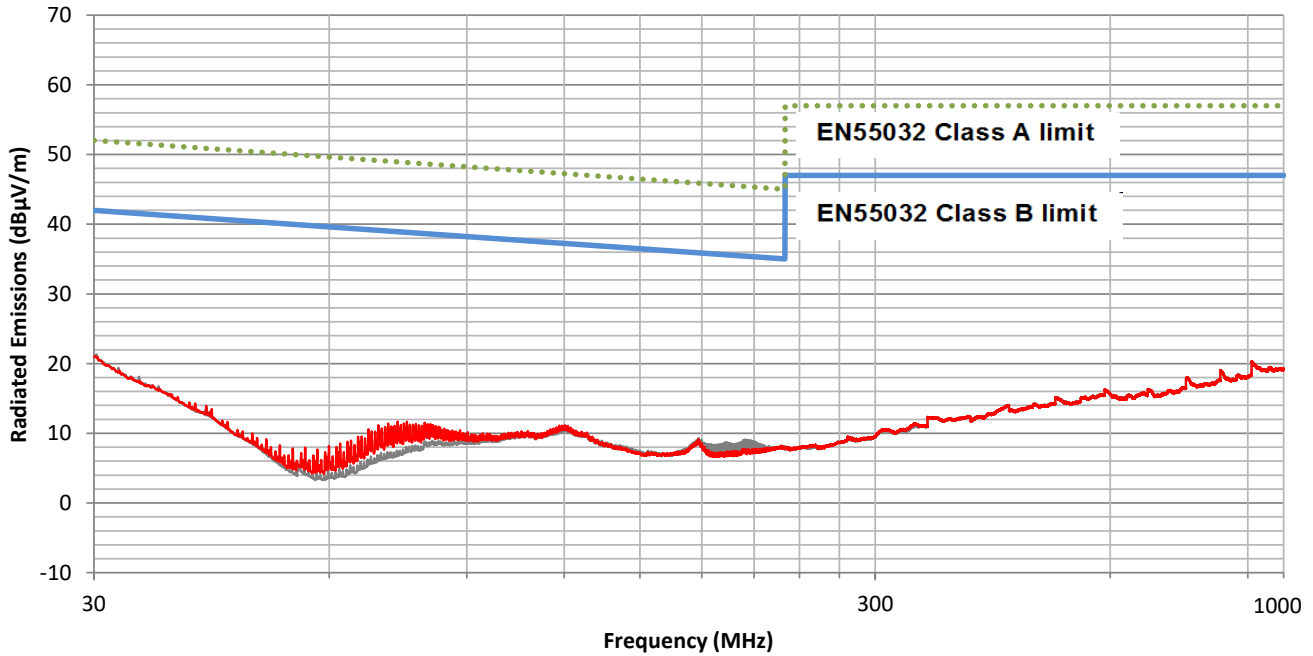

Conducted Emissions 173951536
 $V_{IN} = 24V, V_{OUT} = 15V, I_{LOAD} = 500mA$ with input filter
 C_F and $C_{IN} = 4 \times 4.7\mu F$ (885012209048), $L_F = 1\mu H$ (7447730)
 Average Quasi peak

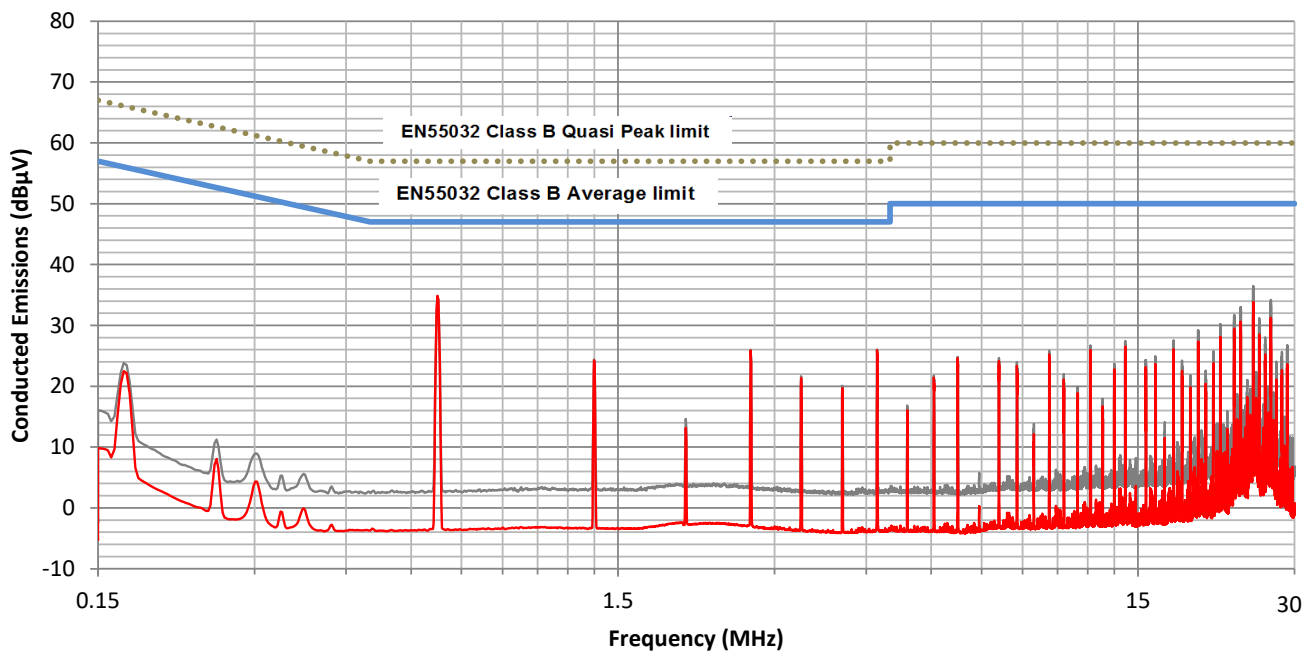

EFFICIENCY - 173950336

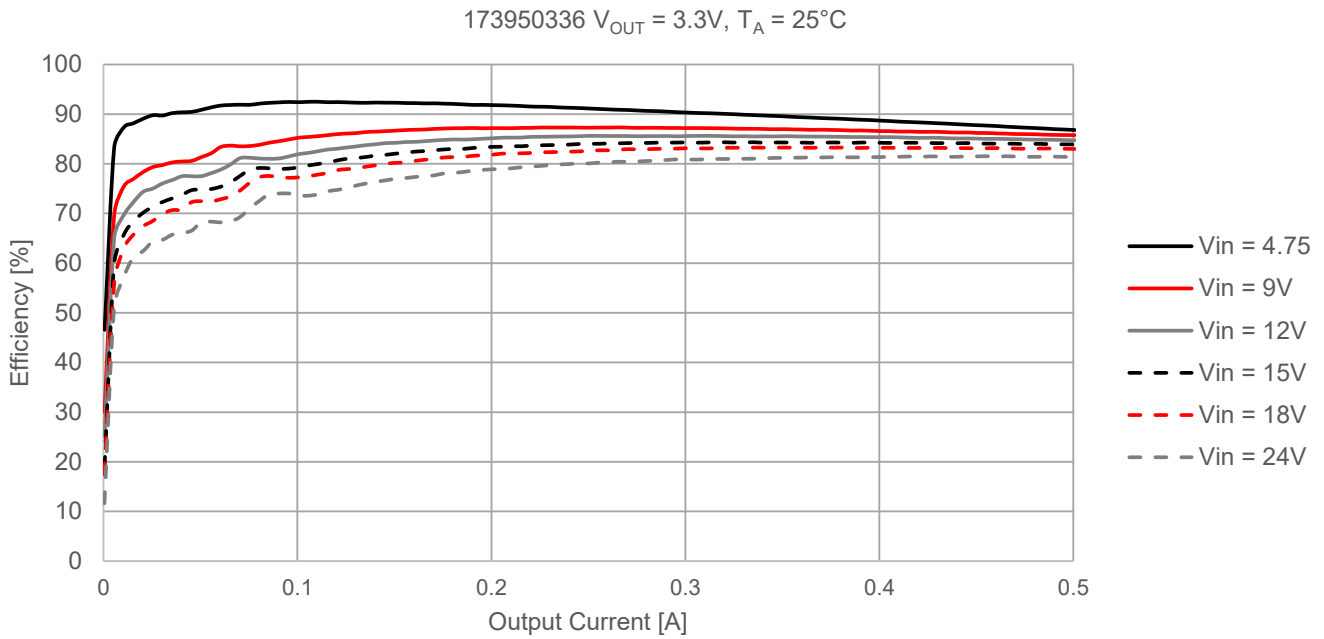

EFFICIENCY - 173950536

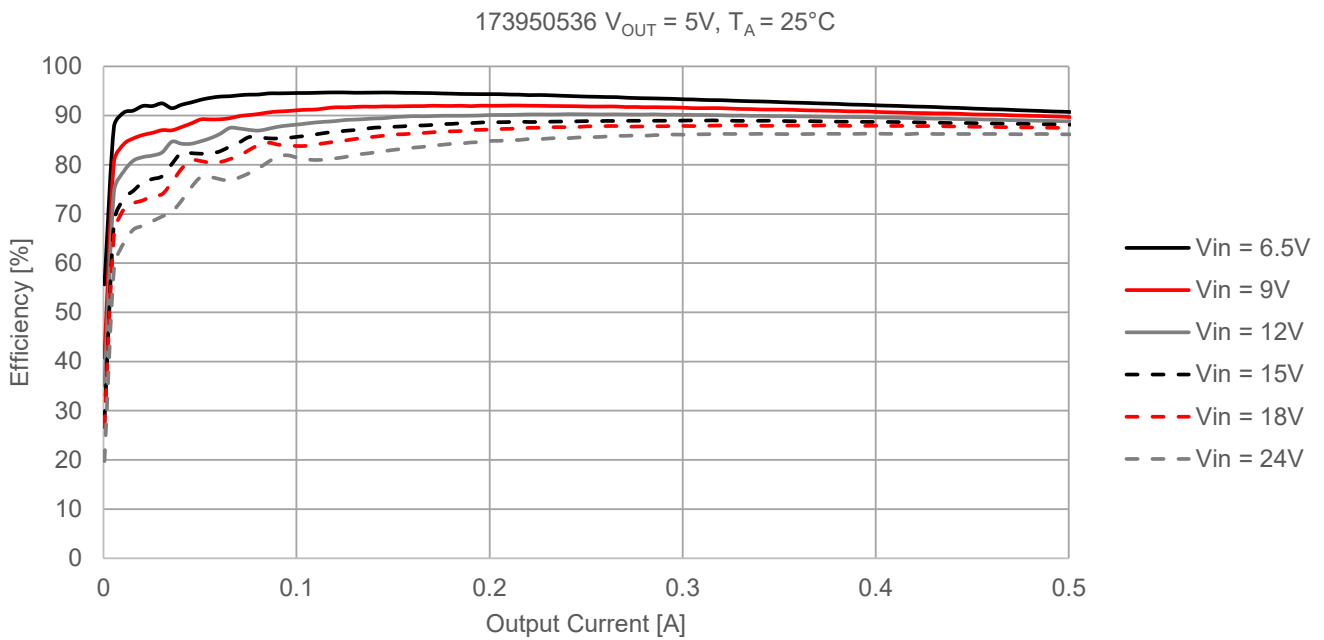

EFFICIENCY - 173951236

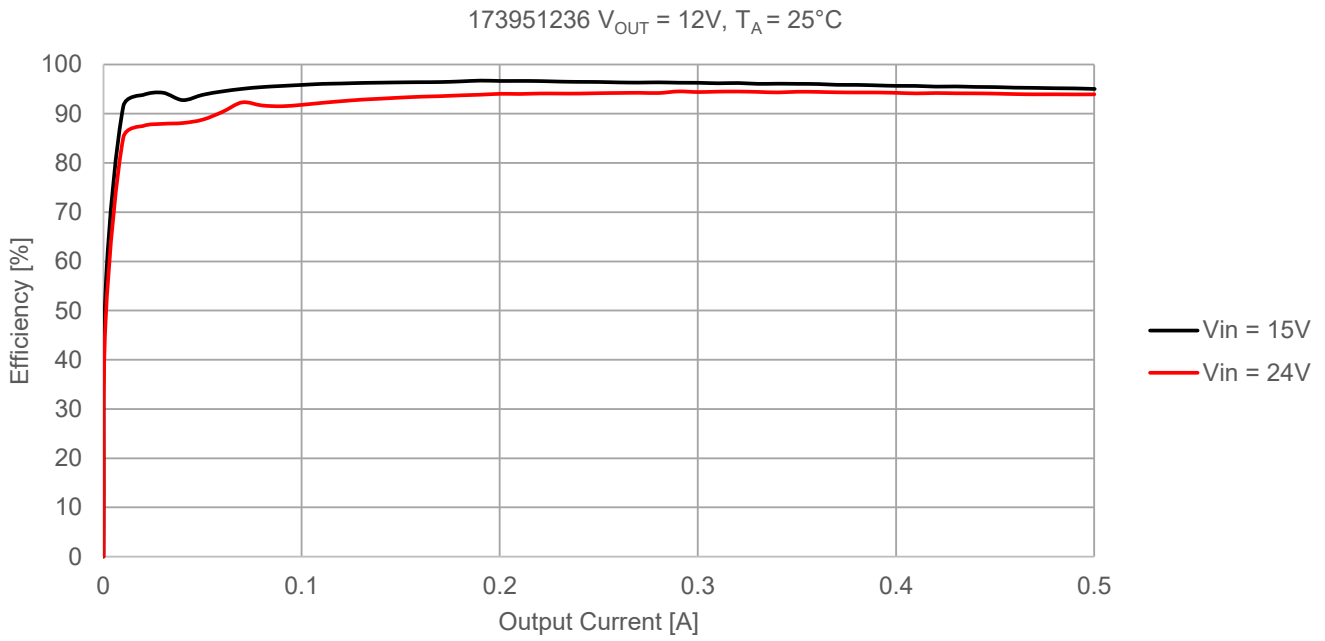

EFFICIENCY - 173951536

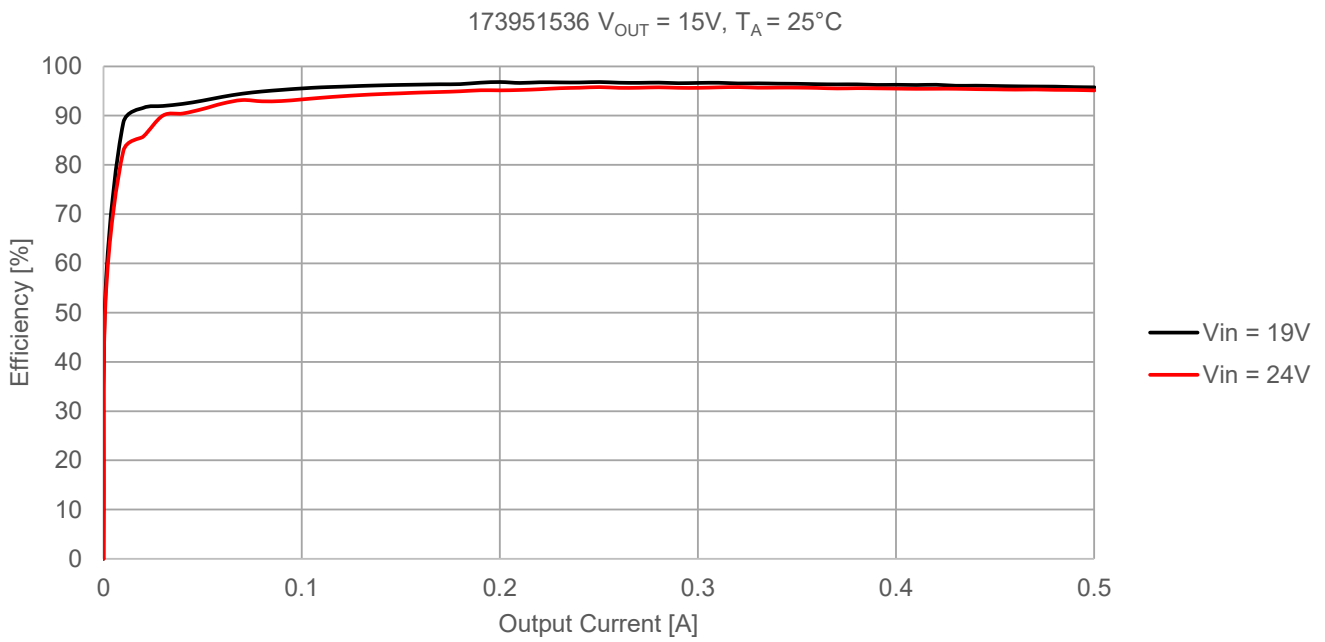

POWER DISSIPATION - 173950336

173950336 $V_{OUT} = 3.3V$, $T_A = 25^\circ C$

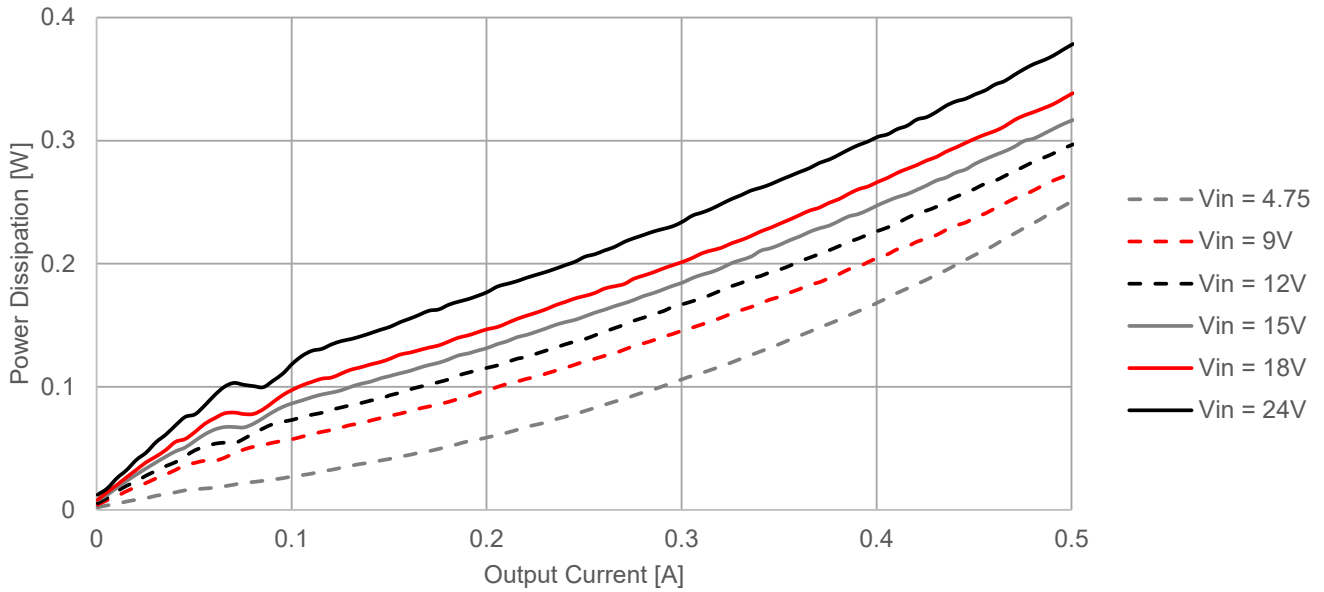

POWER DISSIPATION - 173950536

173950536 $V_{OUT} = 5V$, $T_A = 25^\circ C$

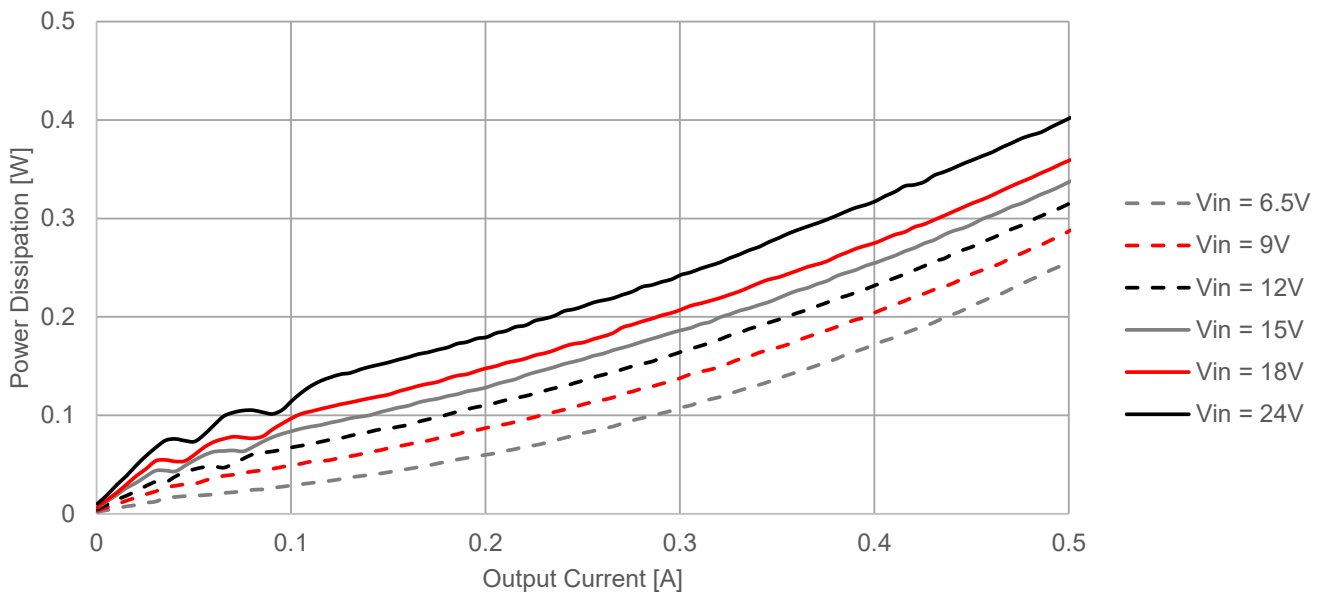

POWER DISSIPATION - 173951236

173951236 $V_{OUT} = 12V$, $T_A = 25^\circ C$

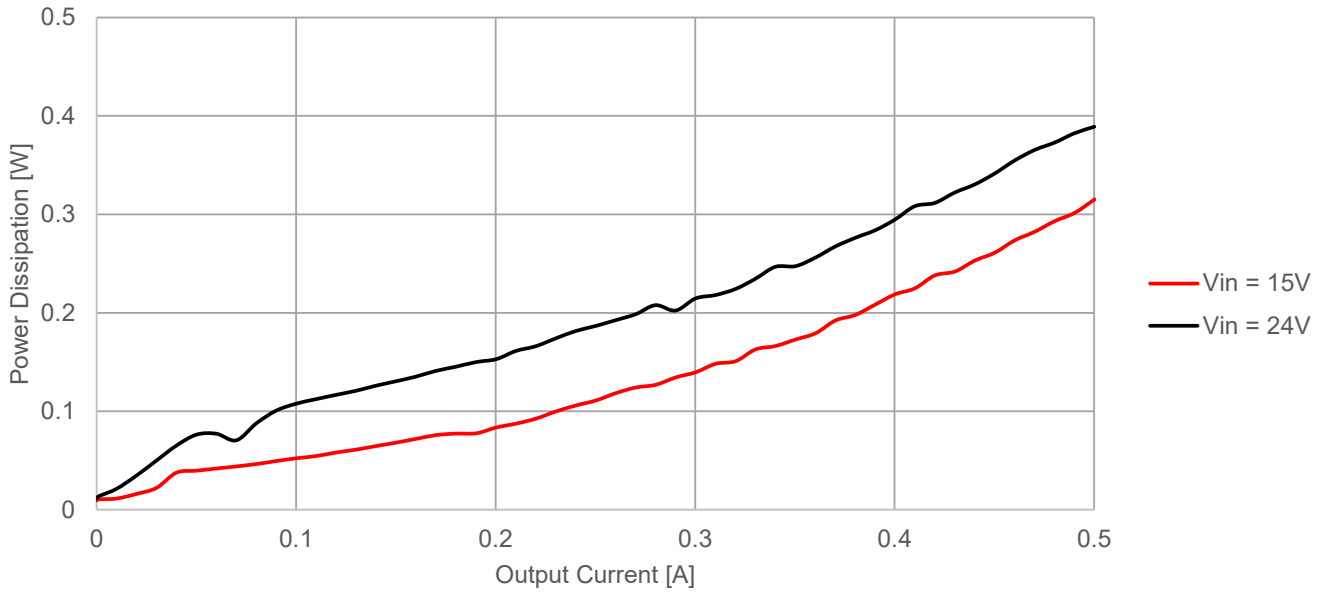

POWER DISSIPATION - 173951536

173951536 $V_{OUT} = 15V$, $T_A = 25^\circ C$

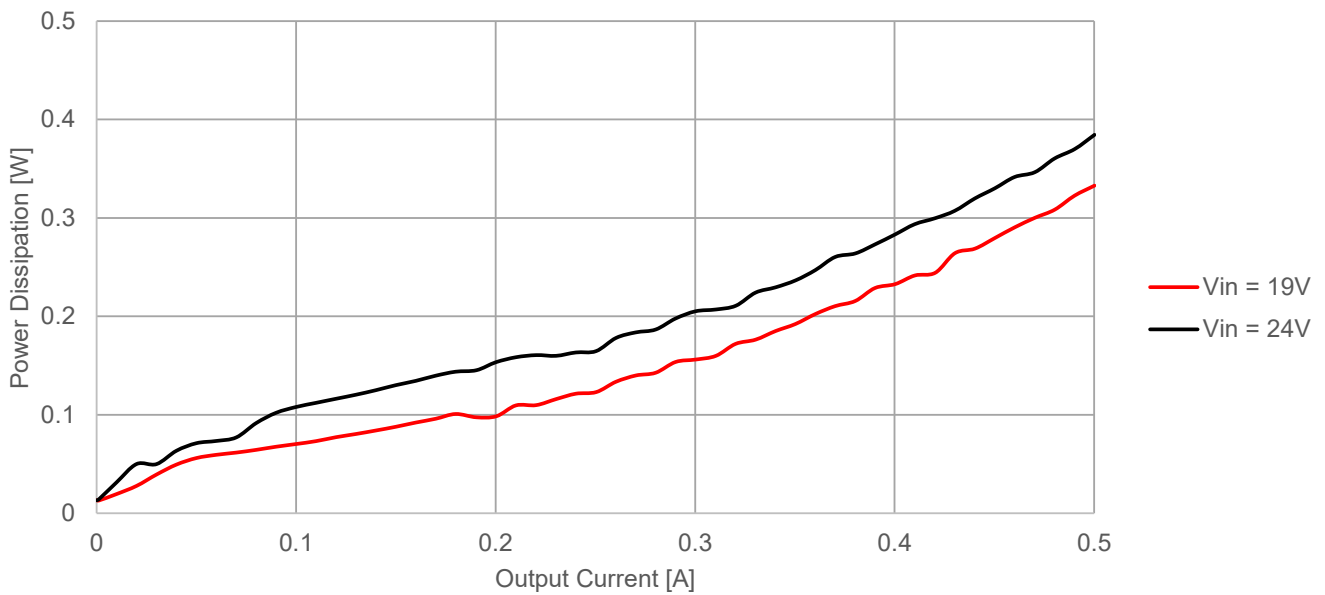

THERMAL DERATING

17395xx36 Output Power Thermal Derating
 $V_{IN} = 24V$, $I_{OUT} = 500mA$

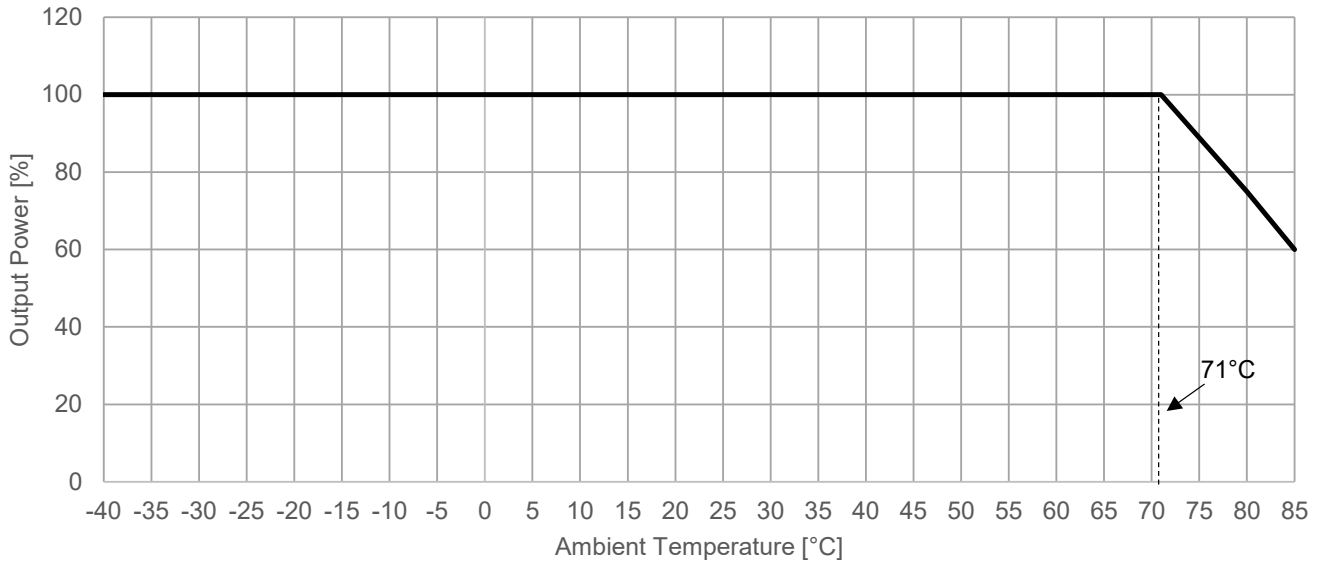

LOAD REGULATION - 173950336

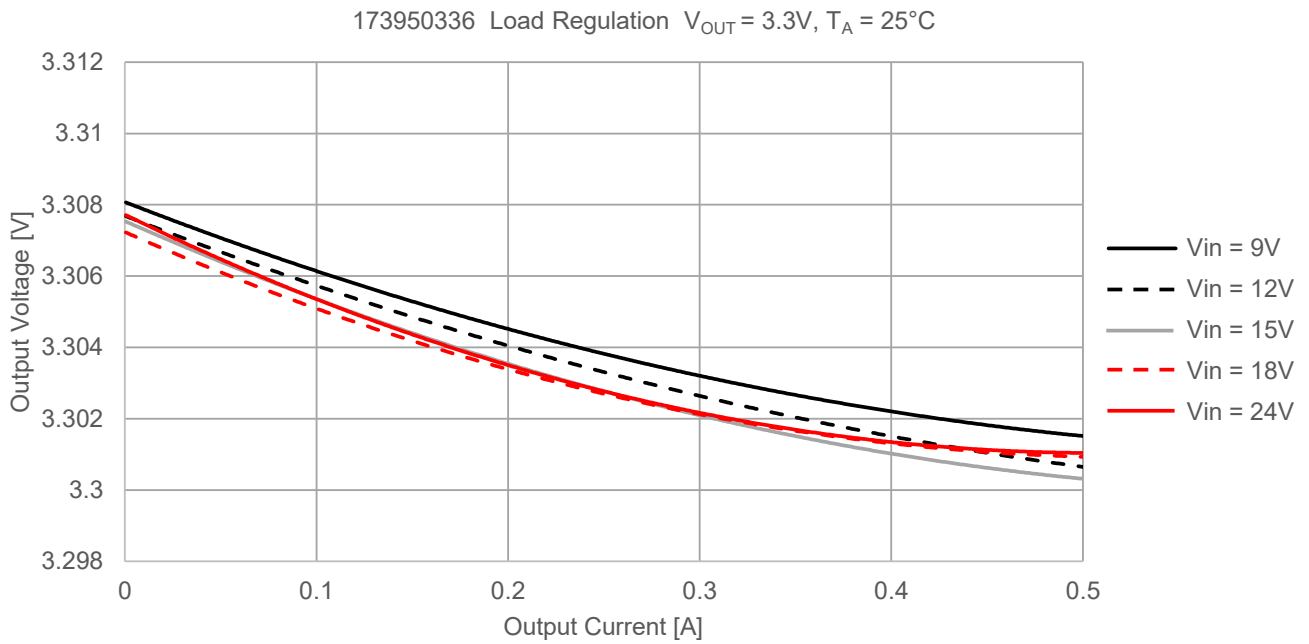

LOAD REGULATION - 173950536

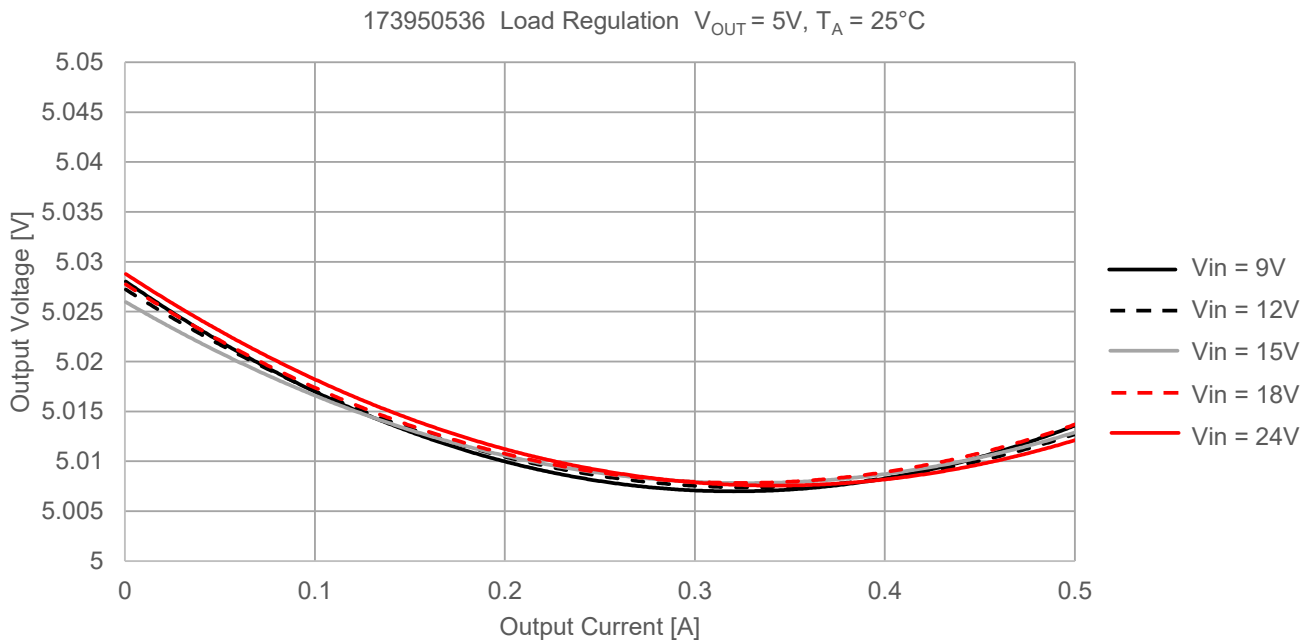

LOAD REGULATION - 173951236

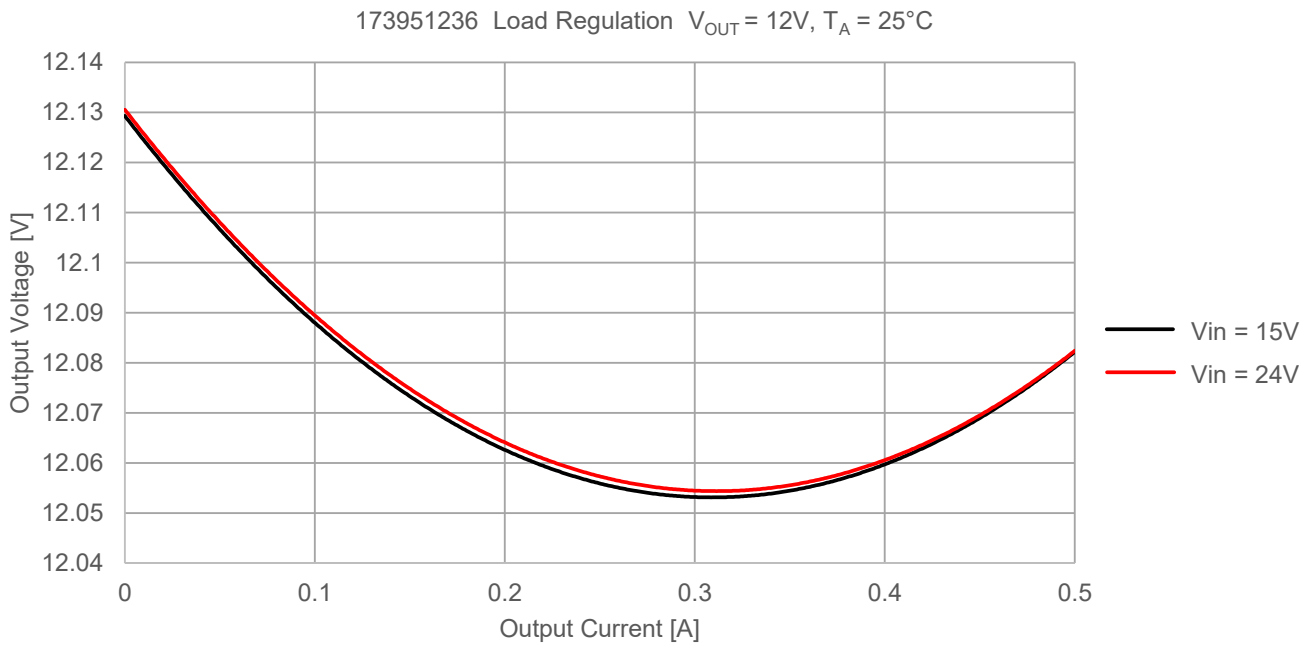

LOAD REGULATION - 173951536

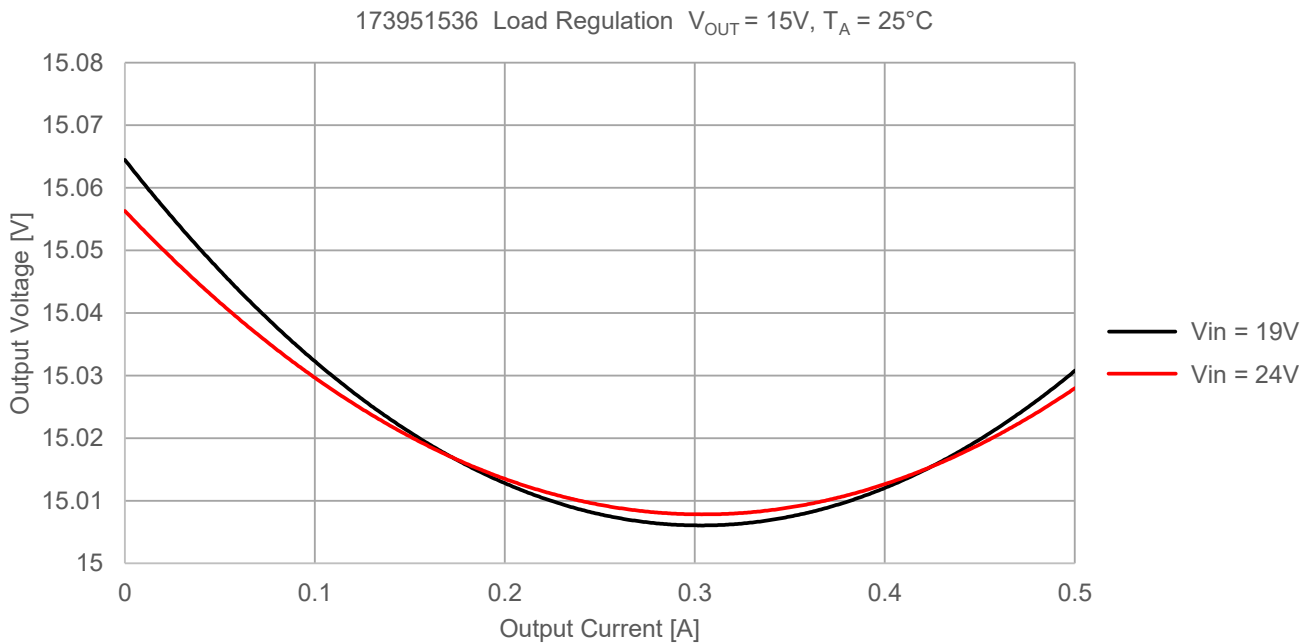

LINE REGULATION - 173950336

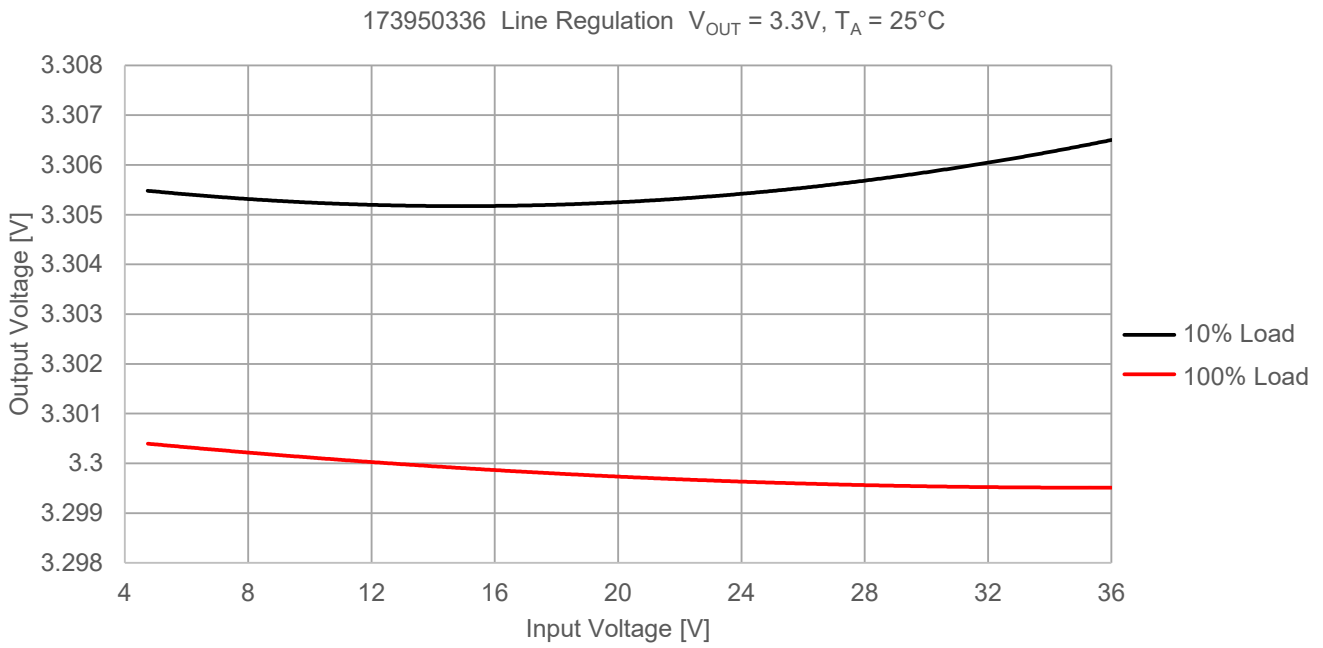

LINE REGULATION - 173950536

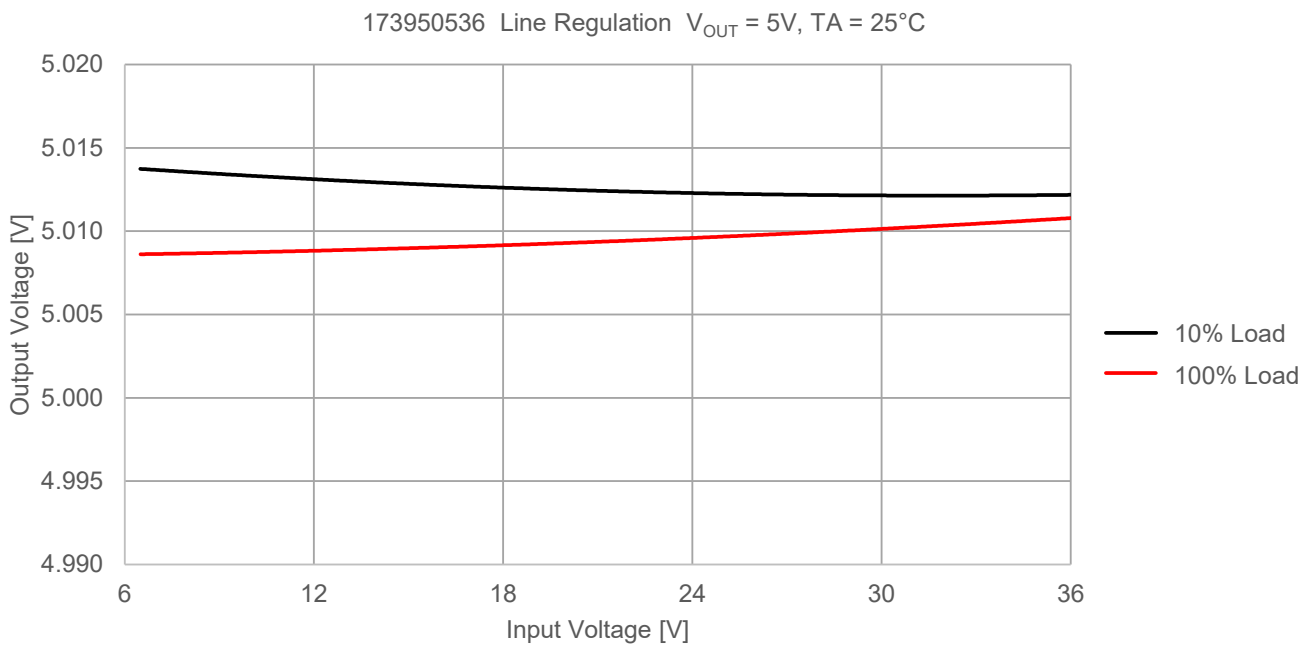

LINE REGULATION - 173951236

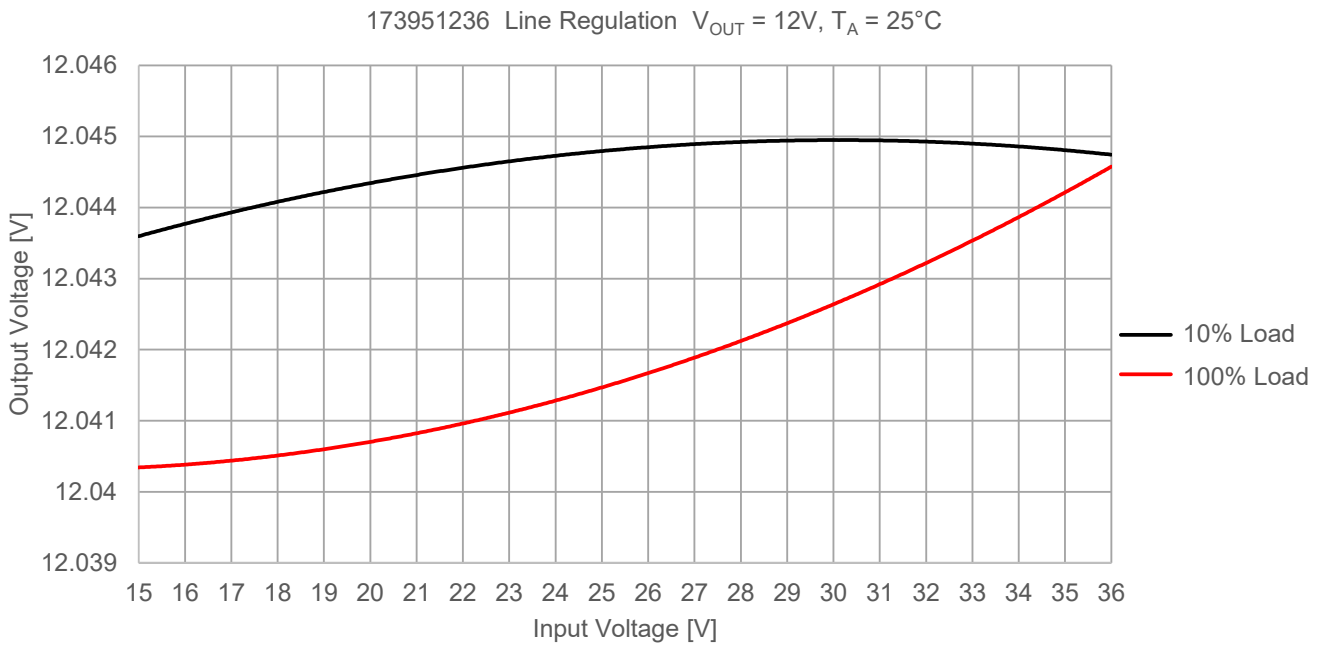

LINE REGULATION - 173951536

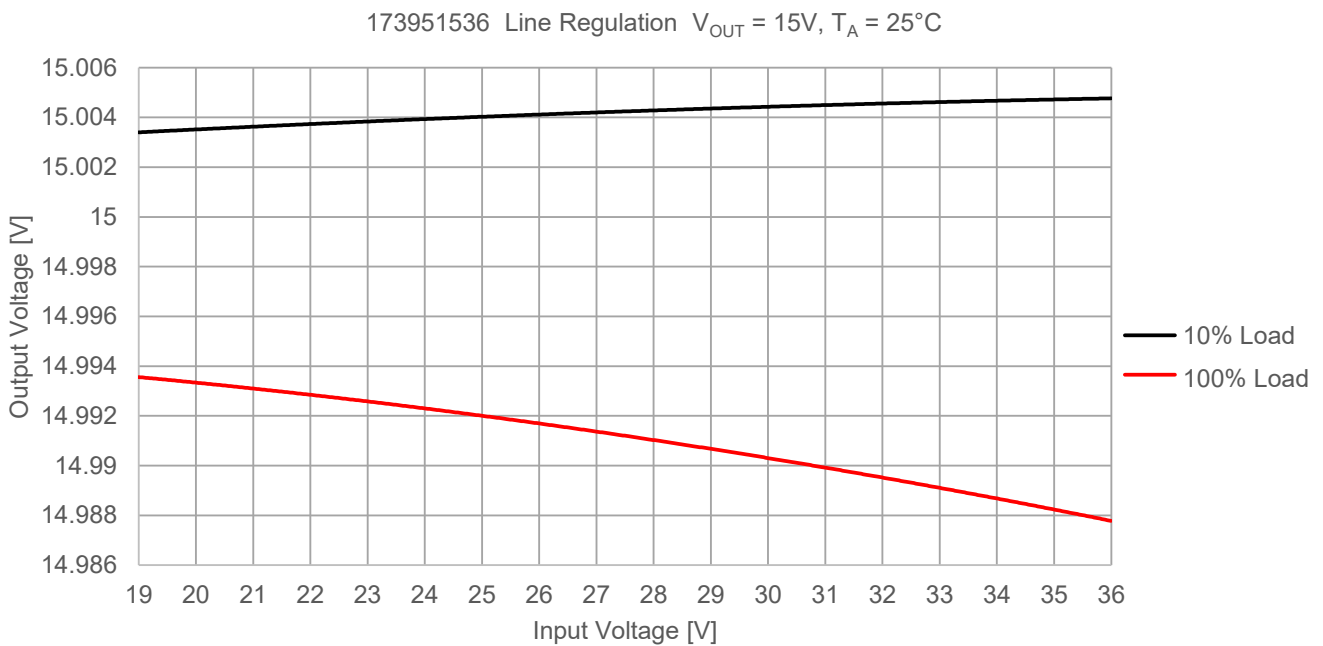

BLOCK DIAGRAM

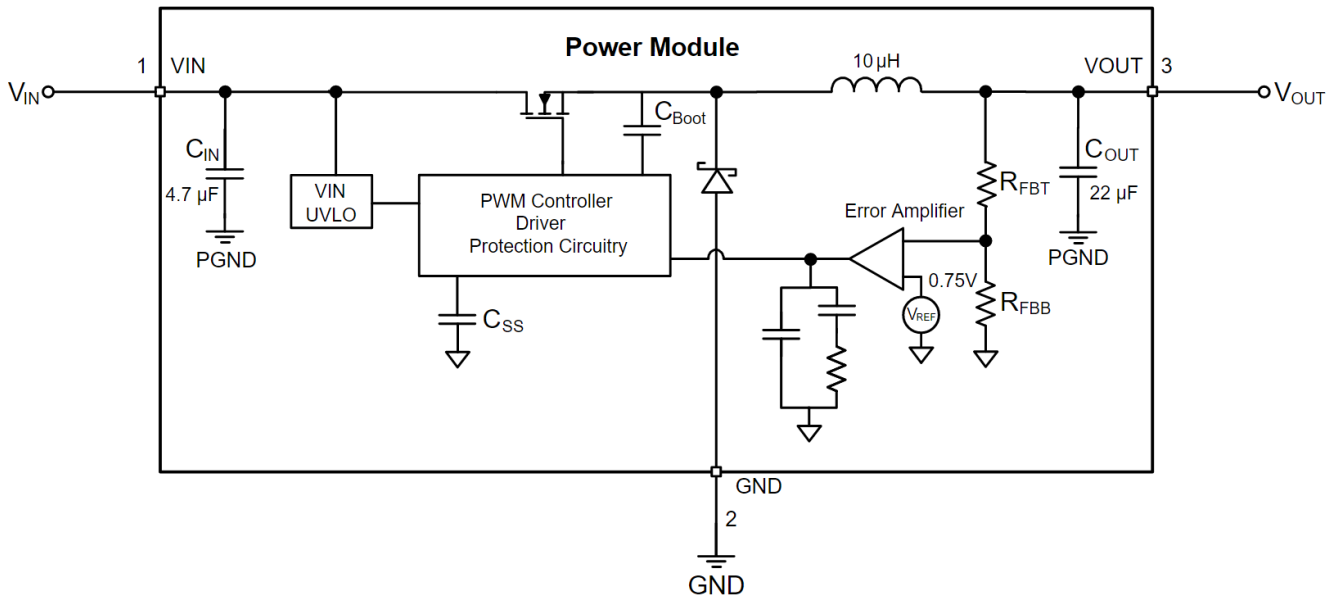

CIRCUIT DESCRIPTION

The MagI³C power modules 173950336, 173950536, 173951236 and 173951536 are all based on a non-synchronous step-down regulator with integrated MOSFET, free-wheeling diode, power inductor, input and output capacitors. The control scheme is based on a current mode (CM) regulation loop.

The V_{OUT} of the regulator is divided with the internal feedback resistor network and fed into the error amplifier, which compares this signal with the internal 0.75V reference. The error amplifier controls the on-time of a fixed frequency pulse width generator, which drives the MOSFET.

The current mode architecture features a constant frequency during load steps. Only the on-time is modulated. It is internally compensated and stable with low ESR output capacitors. No external compensation network is required. This architecture supports fast transient response and very small output voltage ripple values ($<50\text{mV}_{pp}$) are achieved.

LIGHT LOAD OPERATION

Under light load operation, the device switches from PWM mode to PFM mode. The load current where the transition between modes takes place can be estimated using the following formula:

$$I_{OUT(DCM)} = \frac{V_{OUT} \cdot \left(1 - \frac{V_{OUT}}{V_{IN}}\right)}{2 \cdot f_{SW} \cdot L} \quad (1)$$

The following figures show the device working in PWM mode with continuous conduction operation (CCM).

17395xx36 Inductor Ripple Current $V_{IN} = 24V$, $I_{OUT} = 500mA$
 CCM Operation

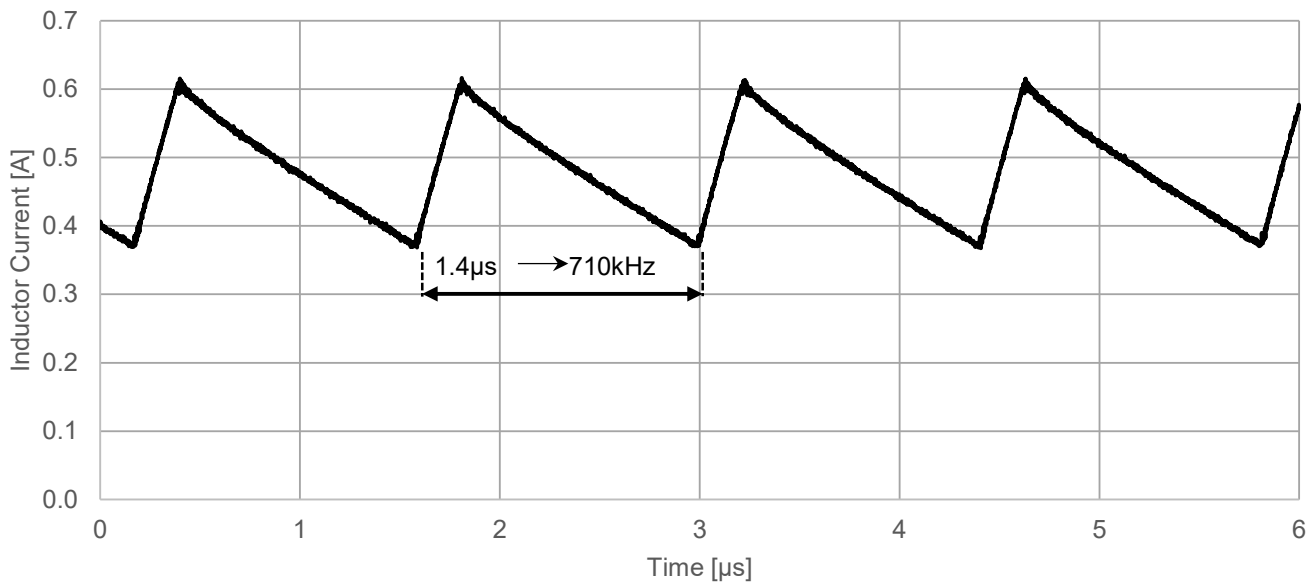

17395xx36 Inductor Ripple Current $V_{IN} = 24V$, $I_{OUT} = 200mA$
 CCM Operation

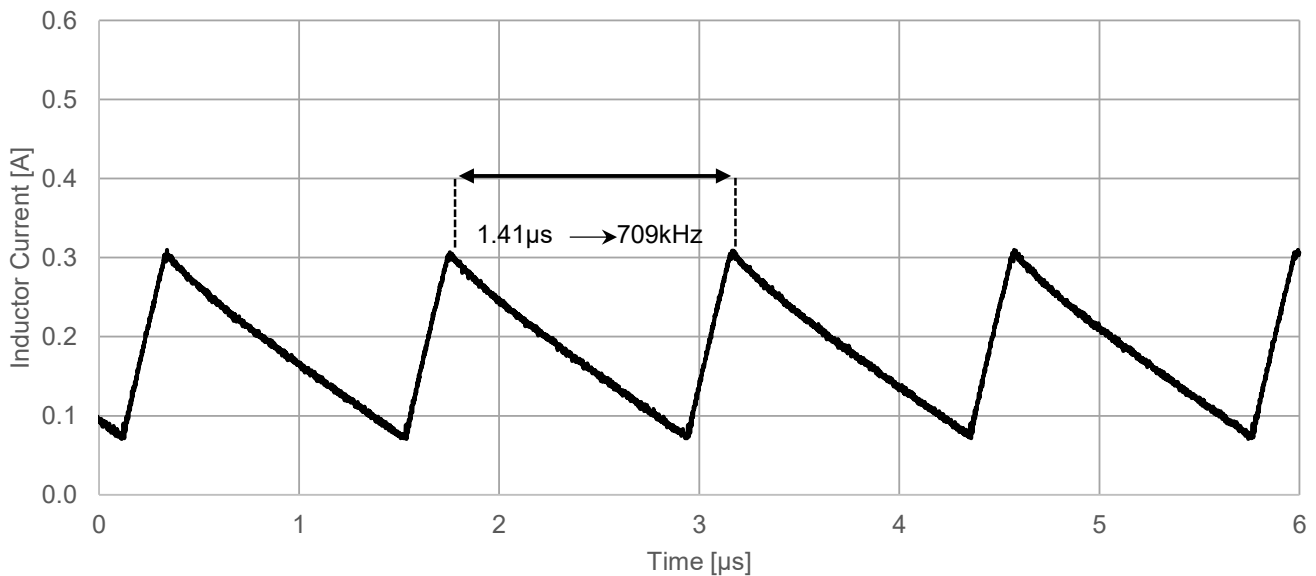

If the load current is further reduced, the device decreases the switching frequency in order to limit the energy transferred to the output (to both the output capacitor and load) maintaining regulation of the output voltage. The frequency reduction is shown in the figure below during PFM mode, with discontinuous operation (DCM).

17395xx36 Inductor Ripple Current $V_{IN} = 24V$, $I_{OUT} = 50mA$
DCM Operation

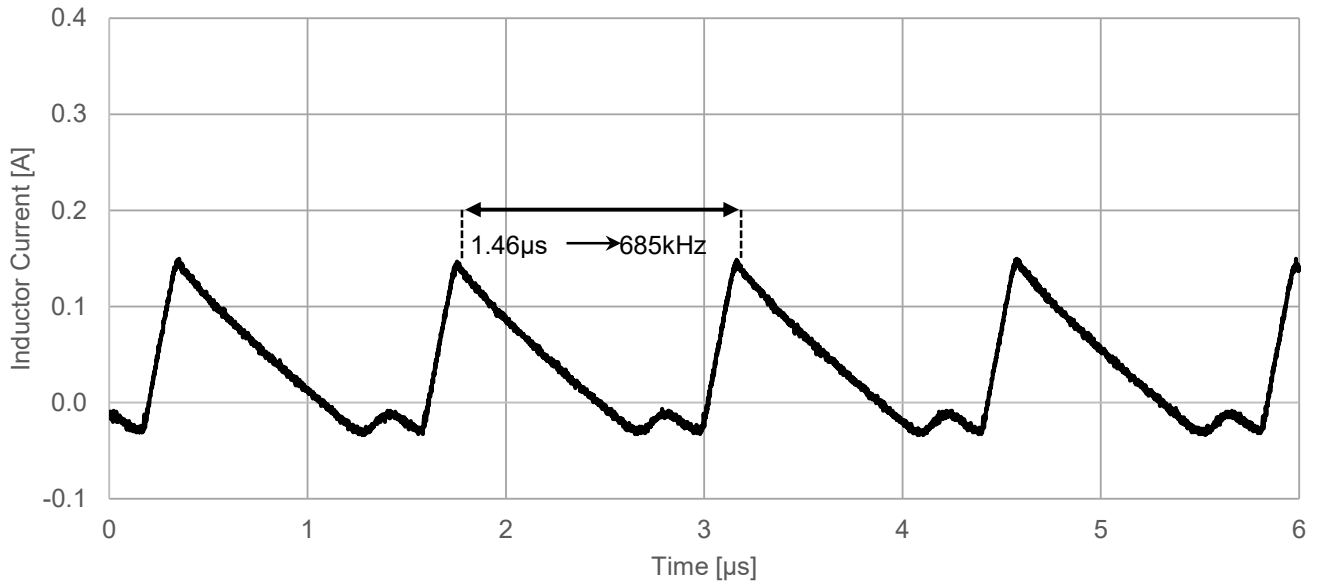

17395xx36 Inductor Ripple Current $V_{IN} = 24V$, $I_{OUT} = 10mA$
DCM Operation

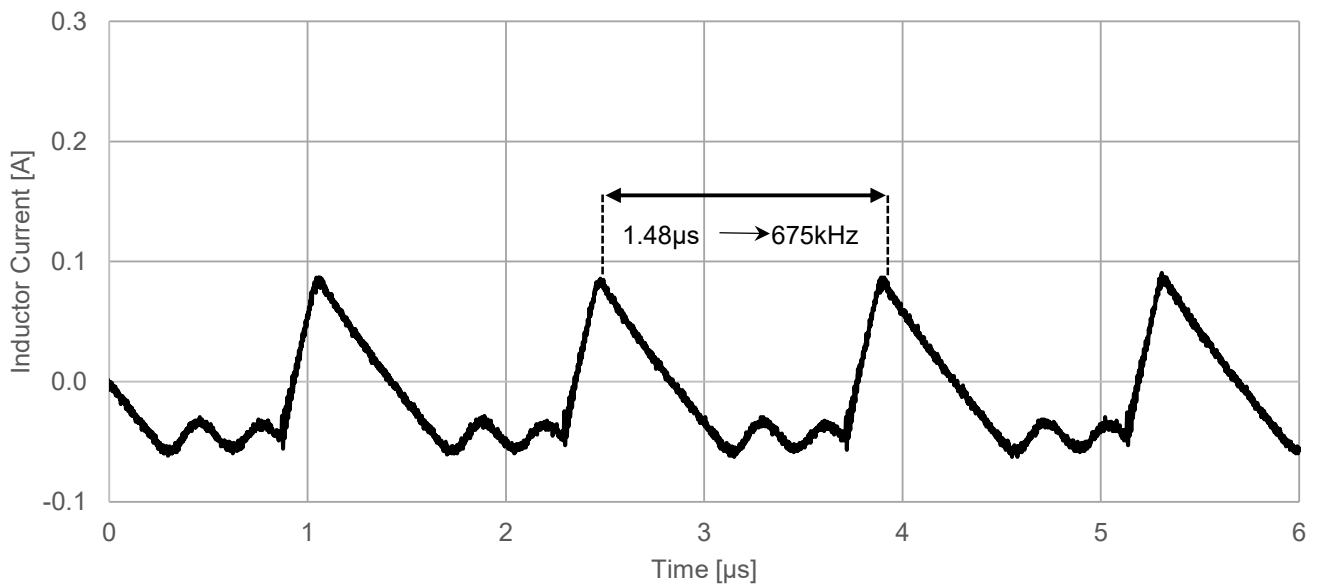

OUTPUT VOLTAGE RIPPLE

The output voltage ripple depends on several parameters. The figure below shows the V_{OUT} ripple at full load using a 22 μ F MLCC output capacitor. An output voltage ripple of less than 50mV_{pp} is measured under the conditions indicated.

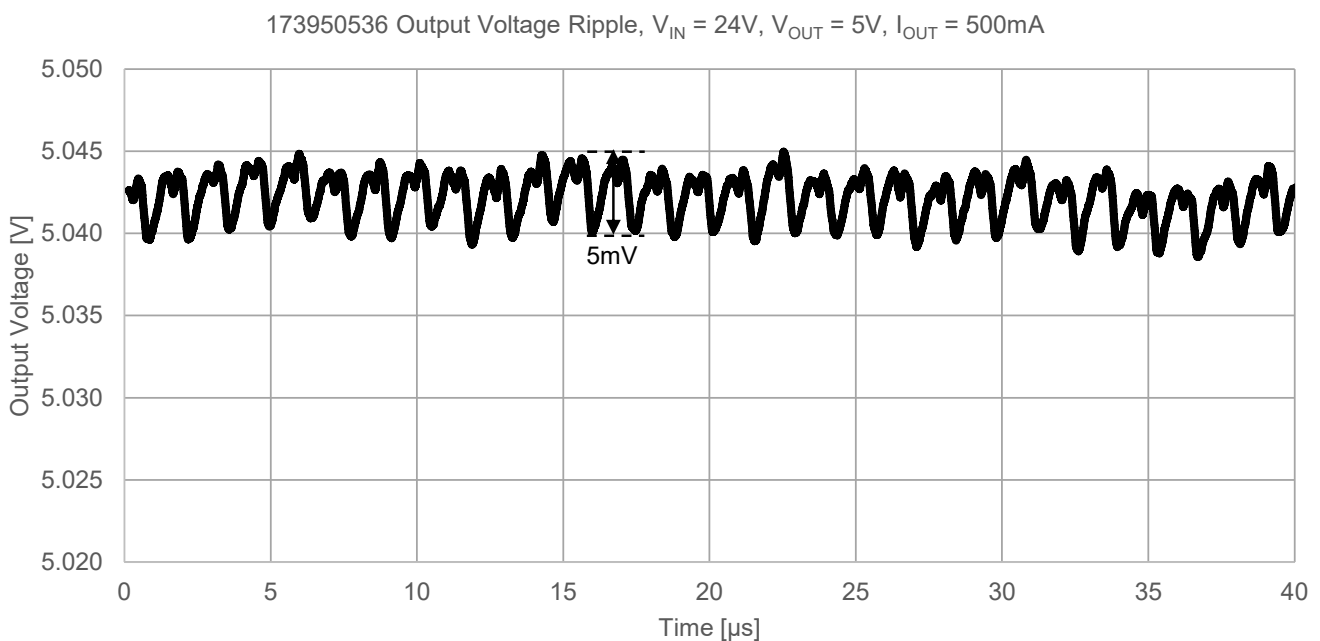
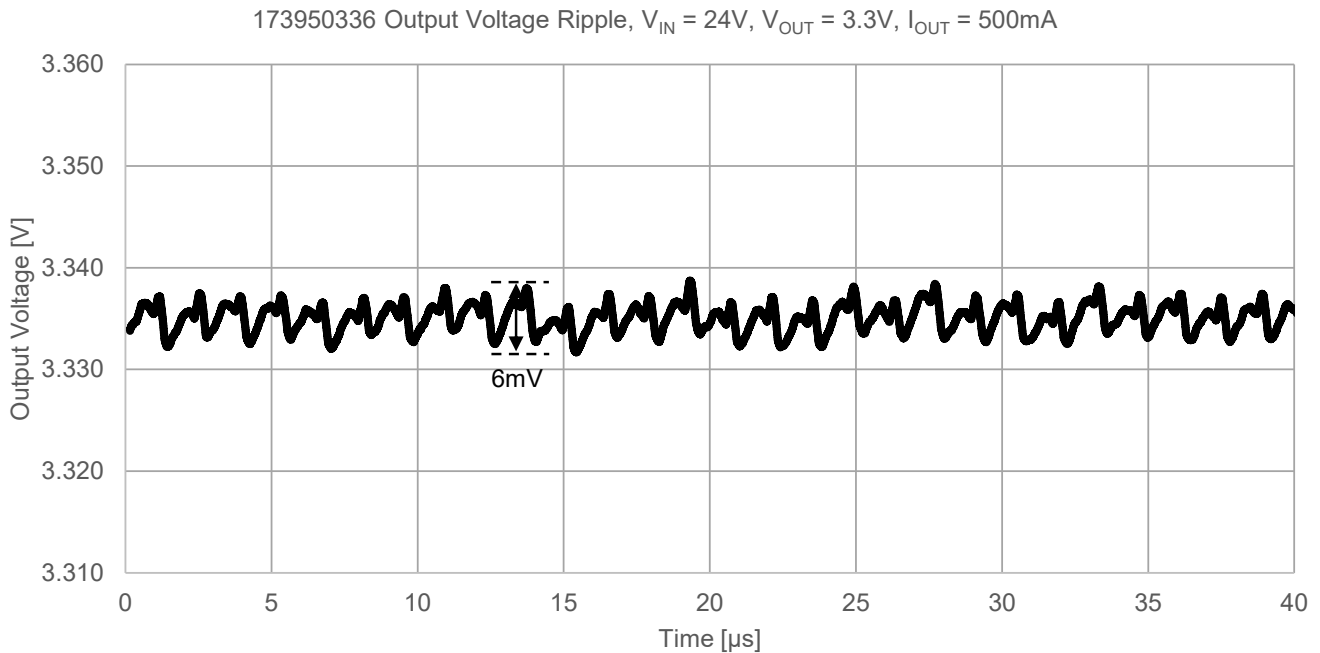

173951236 Output Voltage Ripple, $V_{IN} = 24V$, $V_{OUT} = 12V$, $I_{OUT} = 500mA$

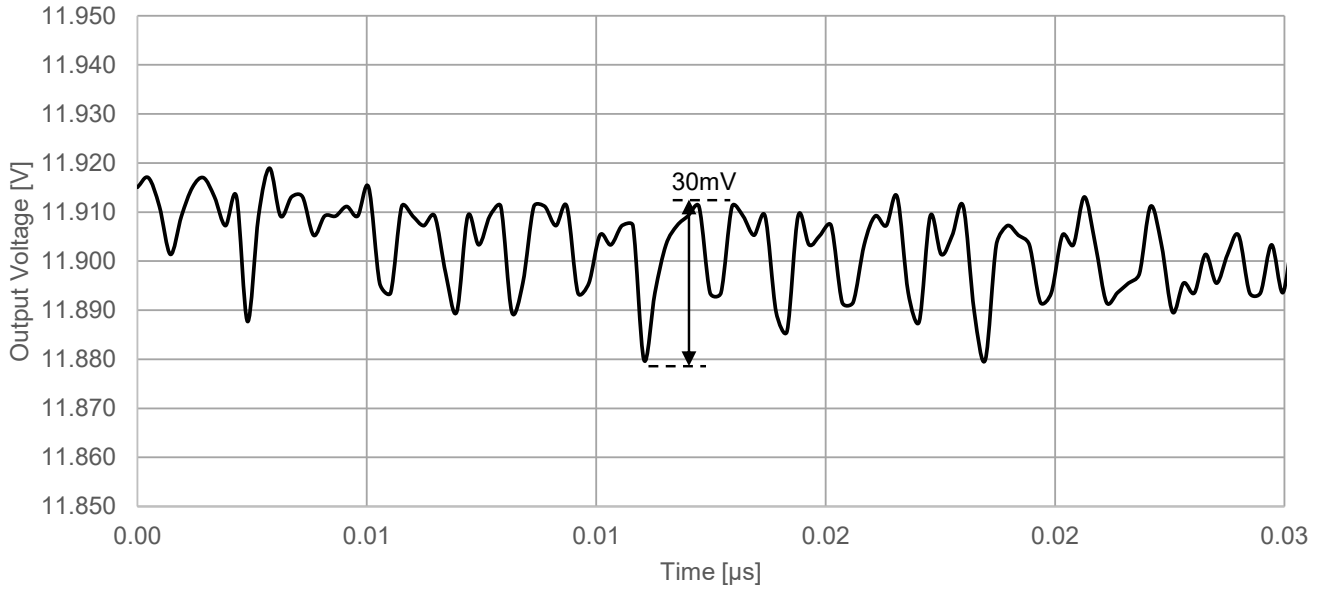

173951536 Output Voltage Ripple, $V_{IN} = 24V$, $V_{OUT} = 15V$, $I_{OUT} = 500mA$

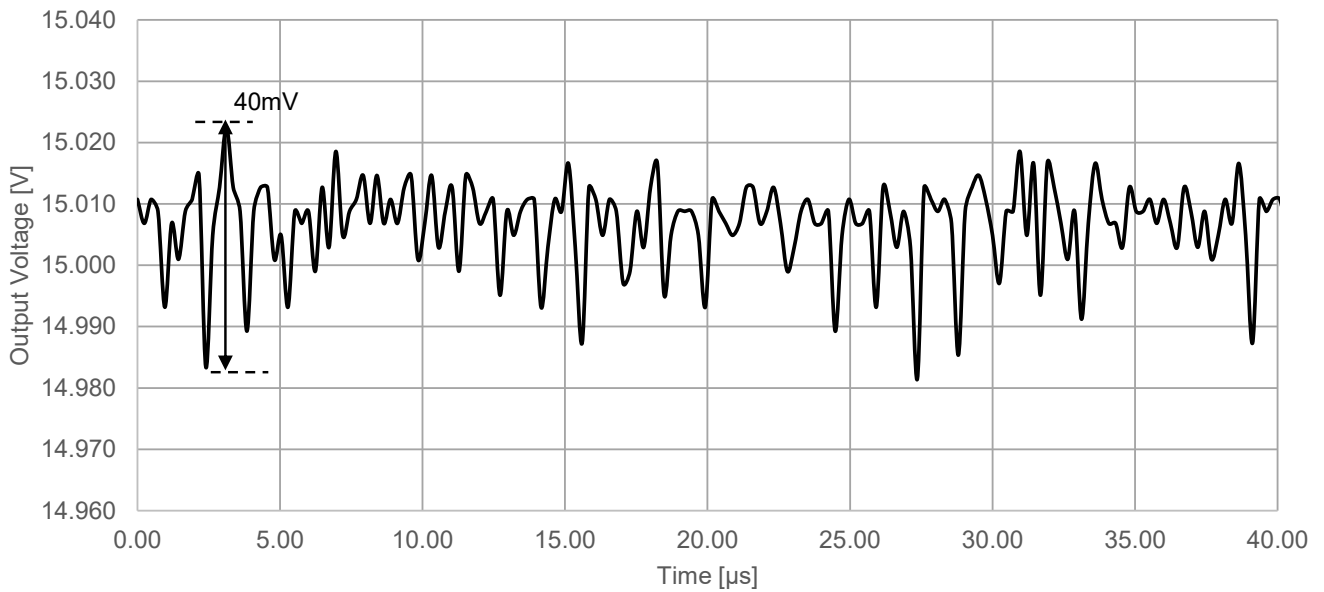

PROTECTION FEATURES

Soft-Start

In order to prevent the output voltage from overshooting during start-up, a soft-start is internally set. The figures below show the start-up behavior of the power module with the 3.3V, 5V, 12V and 15V output voltage, respectively.

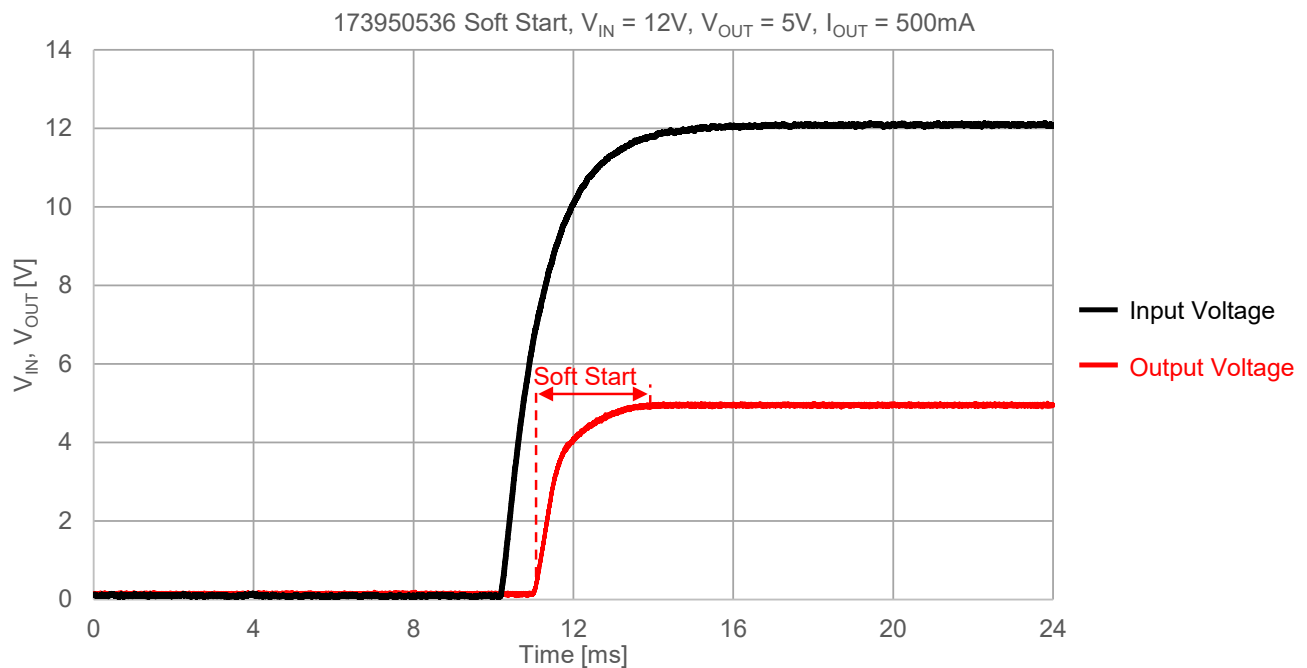
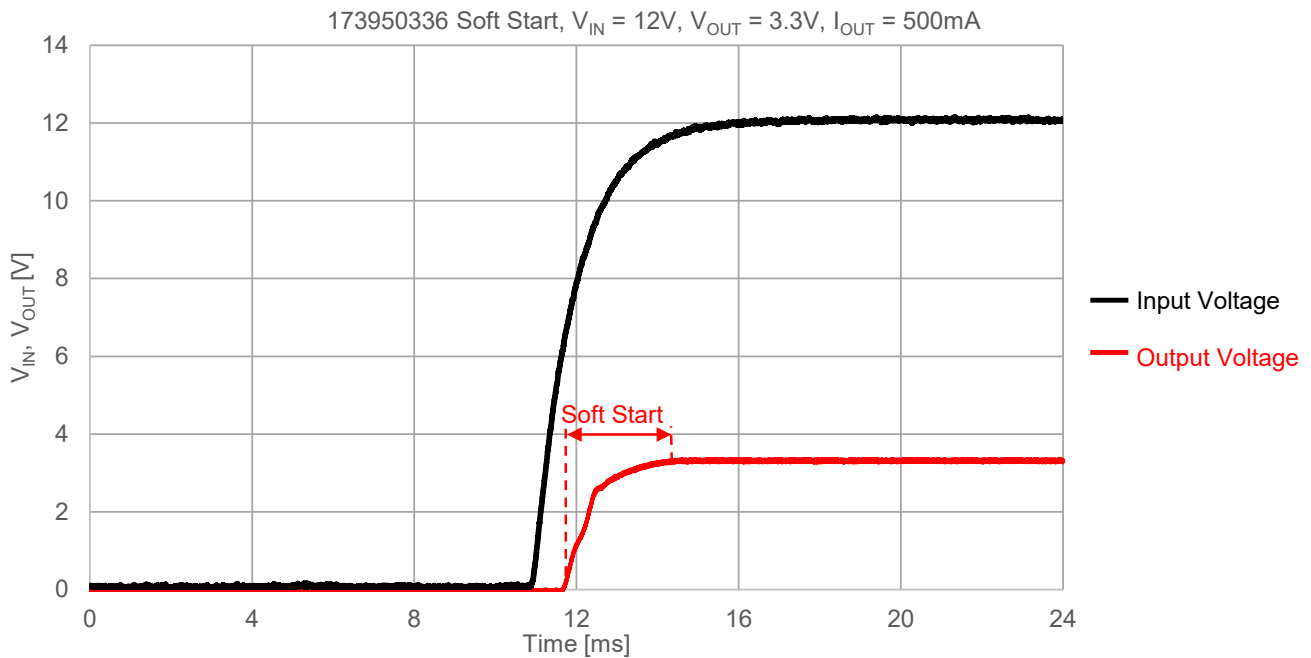

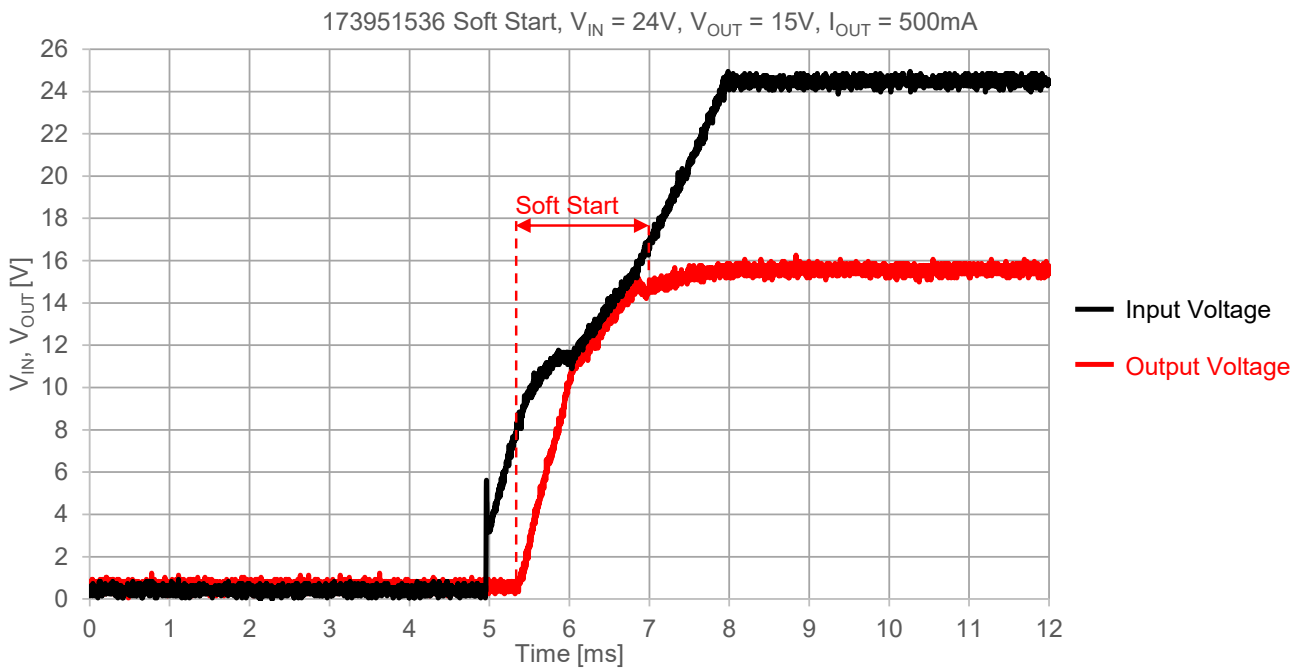
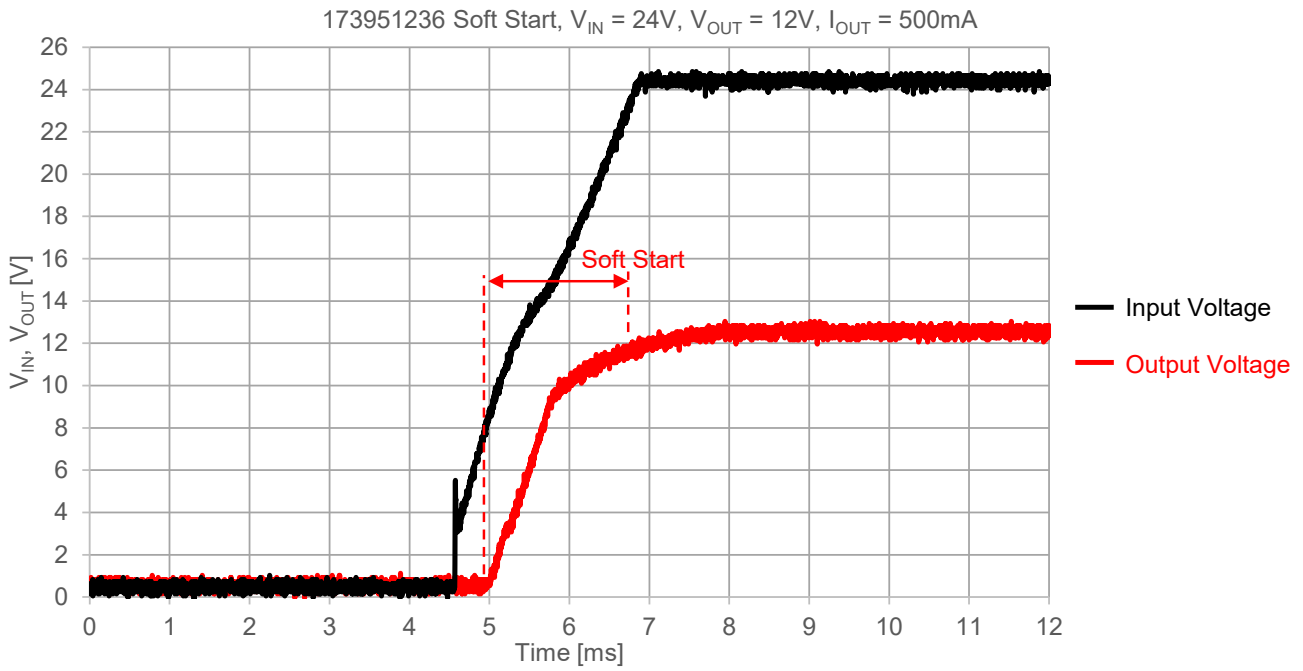

Over Temperature Protection (OTP)

Thermal protection helps to prevent catastrophic failures due to accidental device overheating. The junction temperature of the MagI³C power module should not be allowed to exceed its maximum ratings. Thermal protection is implemented by an internal thermal shutdown circuit which activates at 170 °C (typ.), causing the device to enter a low power standby state. In this state, the MOSFET remains off, causing V_{OUT} to fall. When the junction temperature falls back below 158 °C (typ.) (hysteresis is implemented) V_{OUT} rises smoothly and normal operation resumes. The 173951236 and 173951536 power modules do not have thermal shutdown.

Short Circuit Protection (SCP)

The short circuit protection is realized via cycle by cycle current monitoring and a frequency foldback scheme where the off time of the high side switch increases relative to a decrease of the feedback voltage. For example, the power module switching frequency is divided by 2, 4 and 8 as the feedback voltage decreases to 75%, 50% and 25%, respectively. Recovery from short circuit protection mode occurs during the switching cycle following the removal of the short circuit condition. When the power module recovers from a short circuit condition, the soft-start will not activate. Therefore, an overshoot at the output voltage can be observed (see figure below). Under short circuit conditions, the input current is limited.

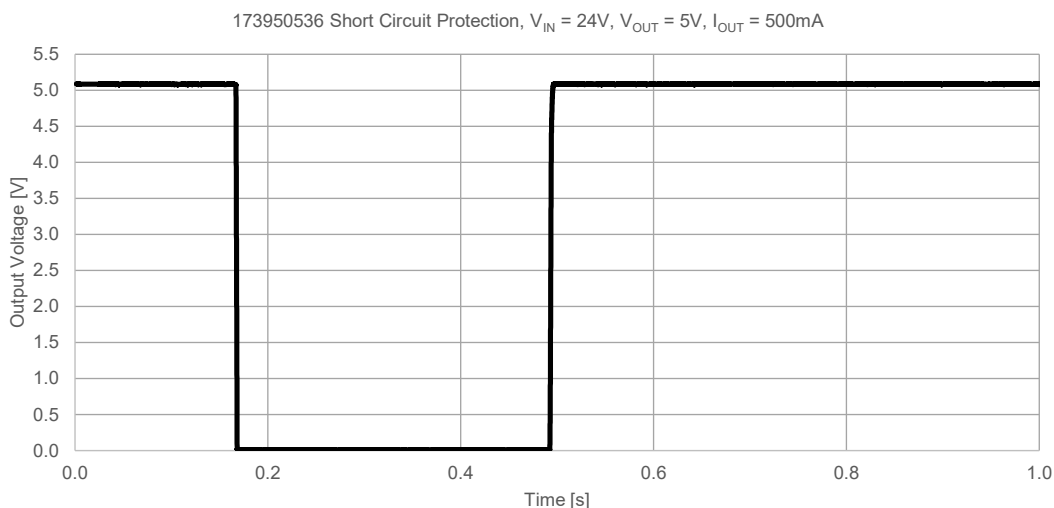
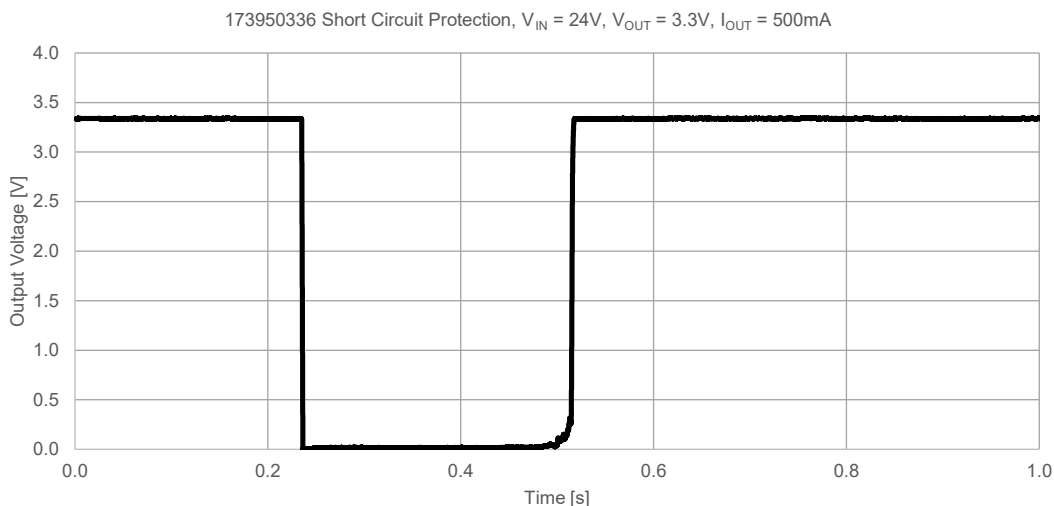

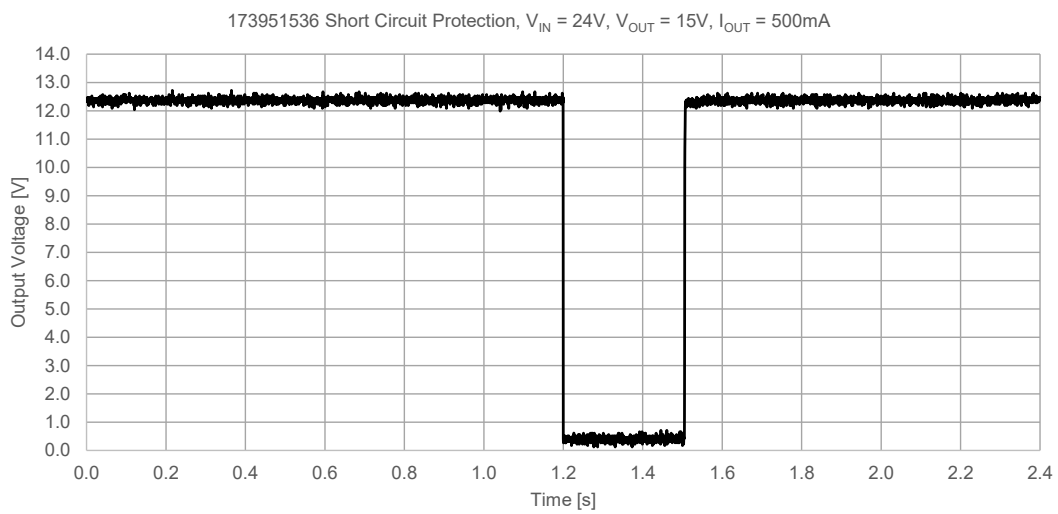
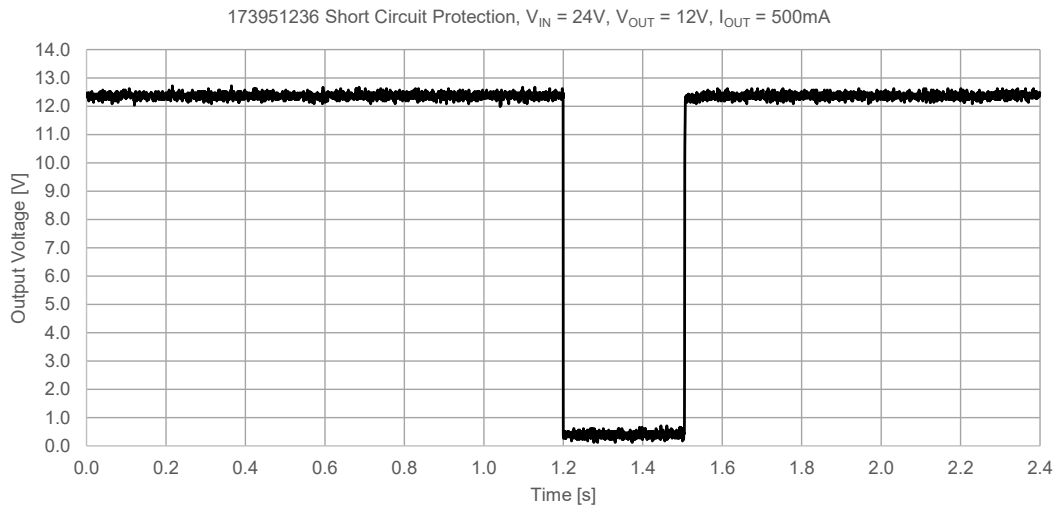

Over Current Protection (OCP)

For protection against load faults, the power module incorporates cycle by cycle current monitoring. During an overcurrent condition the output current is limited and the output voltage drops. When the overcurrent condition is removed, the output voltage returns to the nominal voltage.

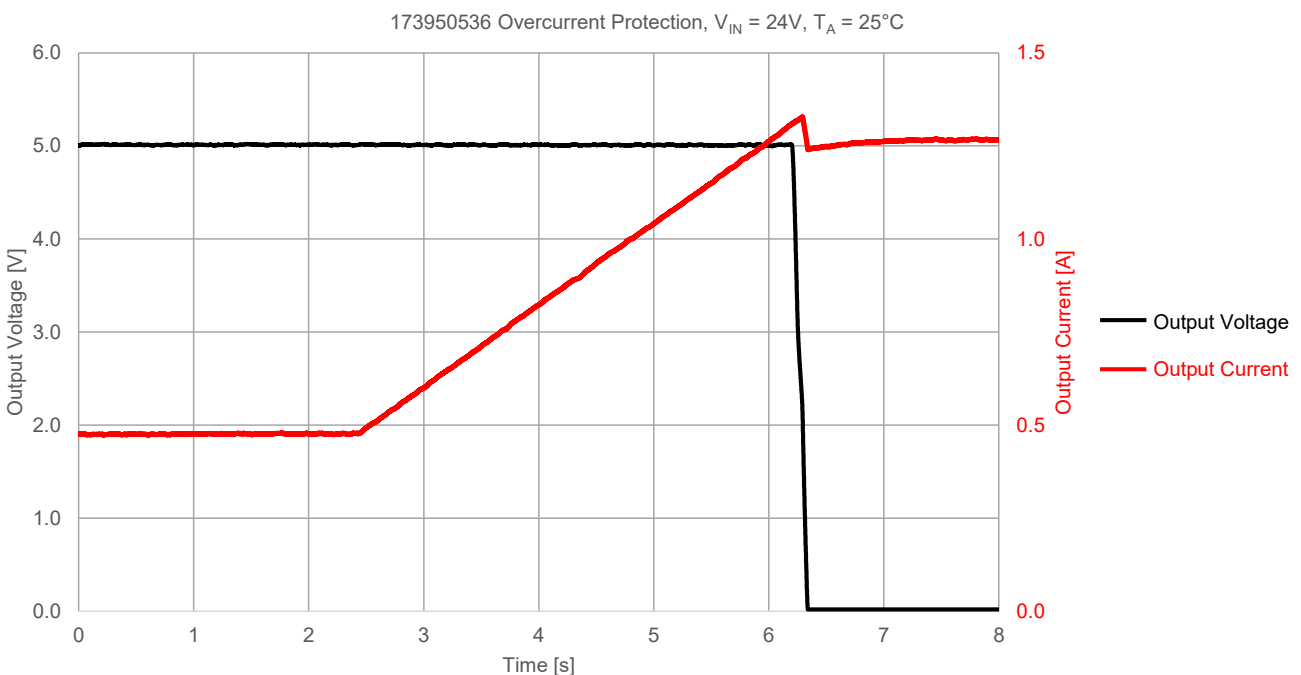
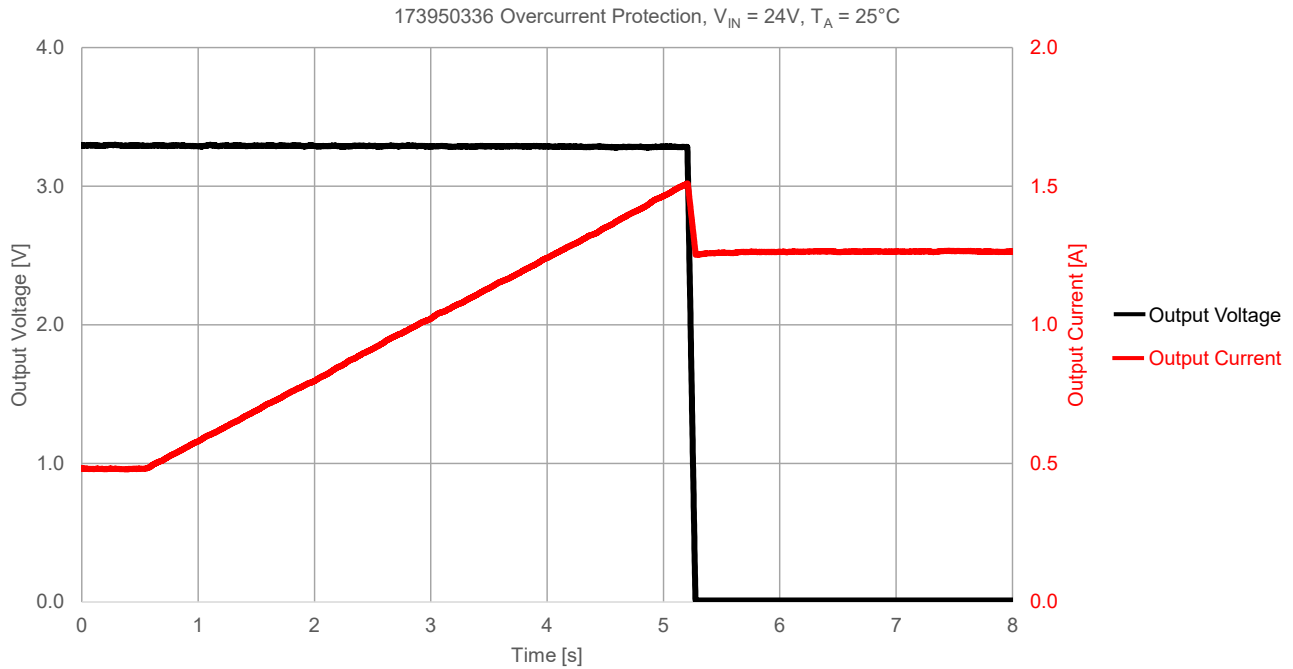

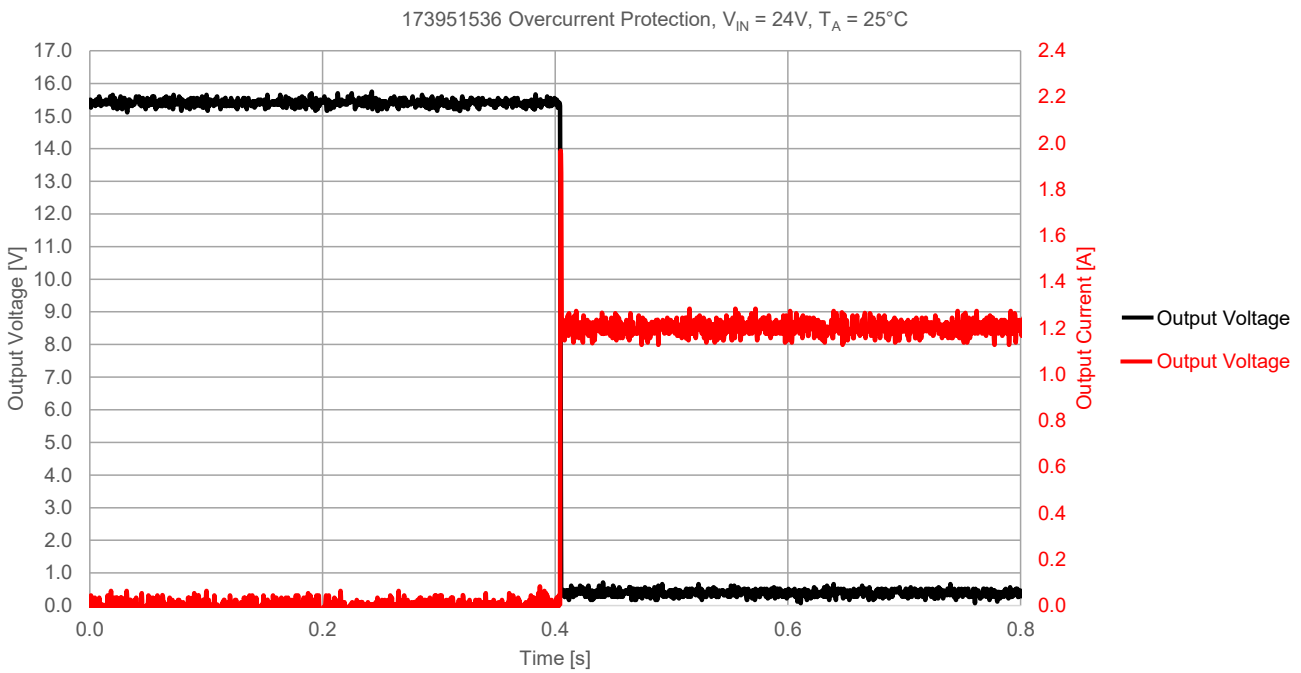
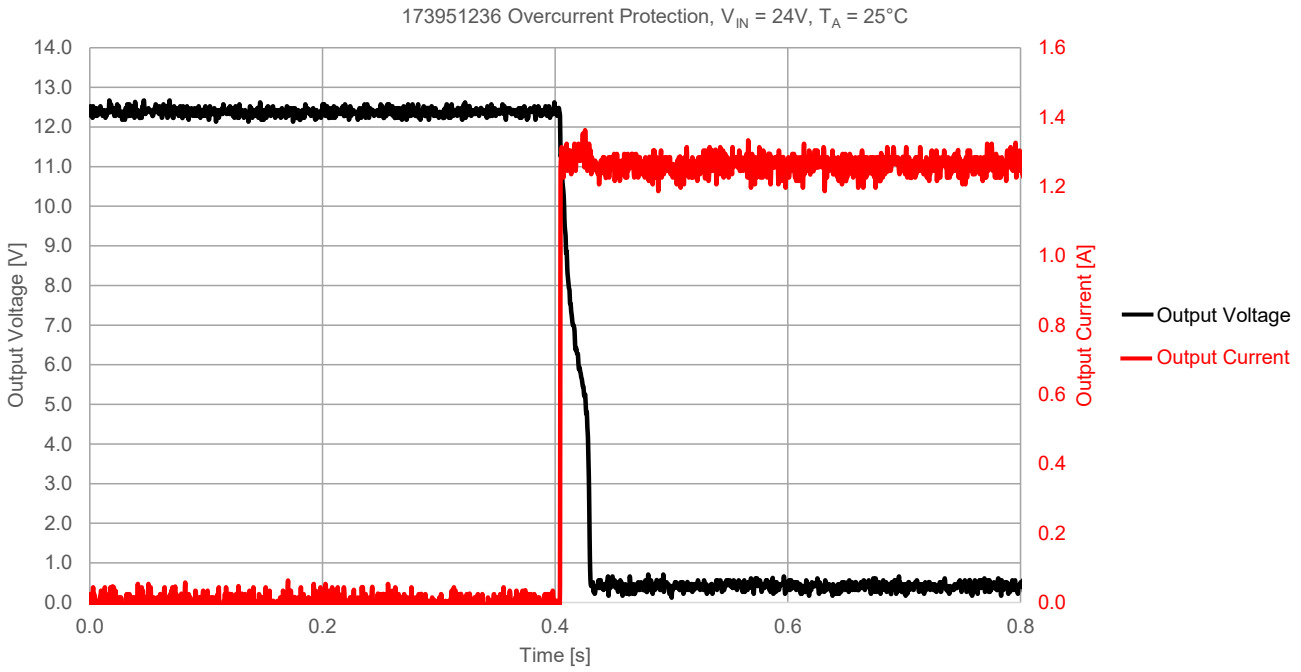

LAYOUT RECOMMENDATION

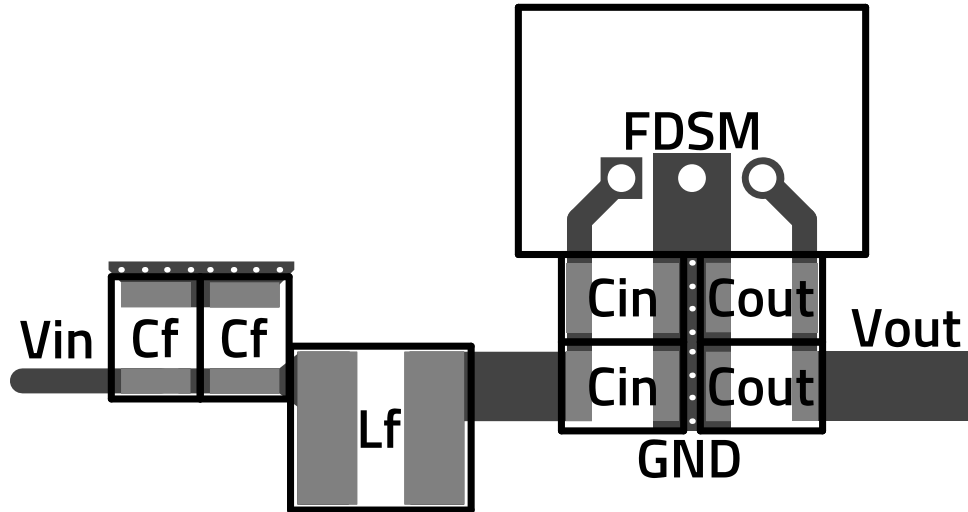

The layout above has been evaluated to provide the optimal performance in terms of transient response, efficiency, ripple and EMI. The design footprint can be reduced at the expense of performance in these parameters. The following recommendation should be followed when designing the layout:

1. The input and output capacitors should be placed as close as possible to the module pins.
2. The input filter should be placed close to the input capacitors of the module.

Recommended External Circuit for Best Performance

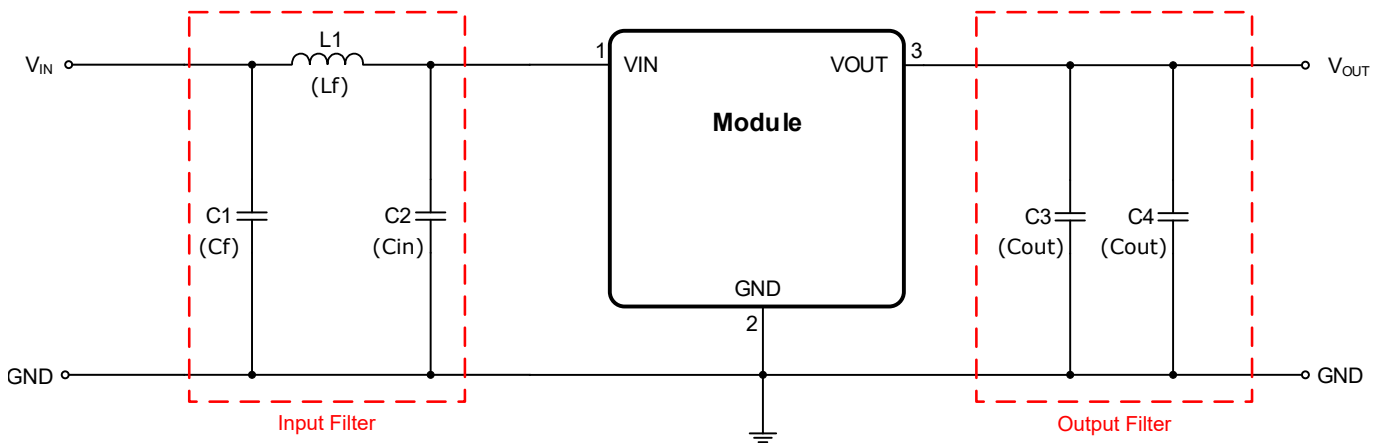

The 17395xx36 family integrates both the input and output capacitors. It is also recommended to use two 10 μ F input capacitors for 173950336 and 173950536 or four 4.7 μ F input capacitors for 173951236 and 173951536, C1 and C2, for high impedance input wires or traces and two 10 μ F output capacitor, C3 and C4, for applications where a low output voltage ripple is required.

Bill of Materials (173950336, 173950536)

Symbol	Description	Filter	Quantity	Order Code	Manufacturer
U1	Magl ³ C Power Module (not mounted)		1	17395xx36	Würth Elektronik
L ₁	Filter inductor, 1 μ H, PD2 family, I _{SAT} =5.72A, I _R =4A	Input	1	7447730	Würth Elektronik
C ₁ , C ₂	Aluminum capacitor 10 μ F/63V	Input	2	875115852001	Würth Elektronik
C ₃ , C ₄	Ceramic chip capacitor 22 μ F/25V X5R, 1210	Output	2	885012109014	Würth Elektronik

Bill of Materials (173951236, 173951536)

Symbol	Description	Filter	Quantity	Order Code	Manufacturer
U1	Magl ³ C Power Module (not mounted)		1	17395xx36	Würth Elektronik
L ₁	Filter inductor, 1 μ H, PD2 family, I _{SAT} =5.72A, I _R =4A	Input	1	7447730	Würth Elektronik
C ₁	Ceramic chip capacitor 4.7 μ F/50V	Input	2	885012209048	Würth Elektronik
C ₂	Ceramic chip capacitor 4.7 μ F/50V		2	885012209048	Würth Elektronik
C ₃ , C ₄	Ceramic chip capacitor 22 μ F/25V X5R, 1210	Output	2	885012109014	Würth Elektronik

Generating Negative Output Voltage

Many industrial applications require negative voltages. The 17395xx36 family can easily provide a negative voltage using the circuit shown below. The module VOUT pin is attached to the application ground and the module GND pin is used to provide the output voltage. For low output voltage ripple, it is recommended to use an additional 22µF external capacitor at the output of the module.

The 173950336 power module is not designed to be operated with a negative output voltage.

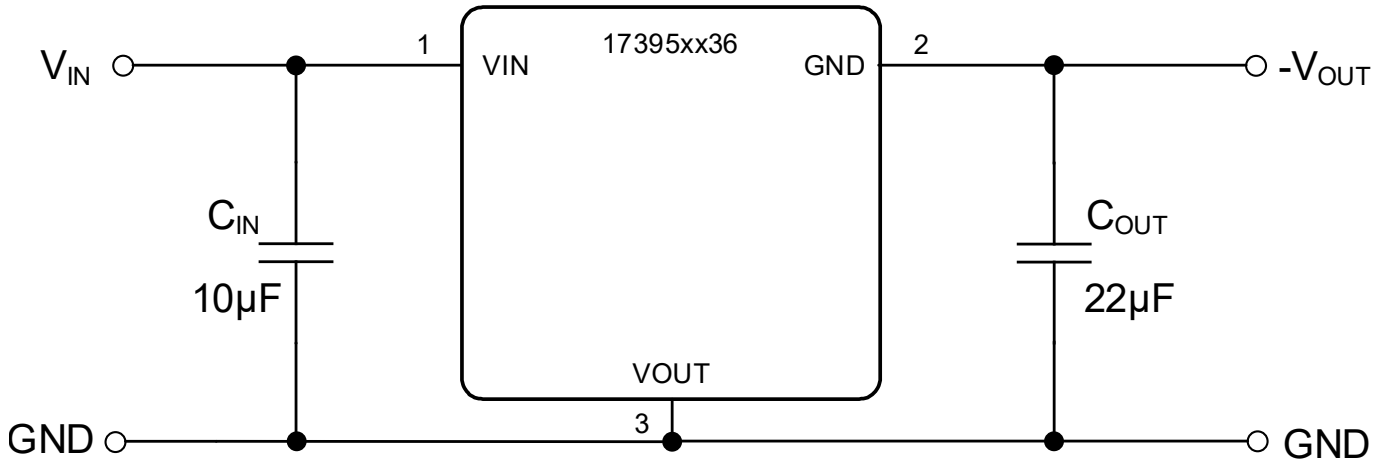

For additional information, please refer to the Application Note [ANS007b](#).

Operating Conditions for Generating Negative Output Voltage:

Part Number	Minimum Vin (V)	Maximum Vin (V)	Maximum Iout (-mA)	Maximum Cout (µF)
173950536	7	31	300	330
173951236	8	24	150	
173951536	8	21	150	

Generating Complementary Output Voltage

Another common requirement in industrial applications is to provide a complementary voltage (e.g. $\pm 5V$). The circuit below shows how this target can be achieved simply combining one of the 17395xx36 family used in a standard configuration (delivering a positive output voltage) with the above mentioned solution for negative voltages. For low output voltage ripple, it is recommended to use an additional $22\mu F$ external capacitor at the output of the module. The 173950336 power module is not designed to be operated with a negative output voltage.

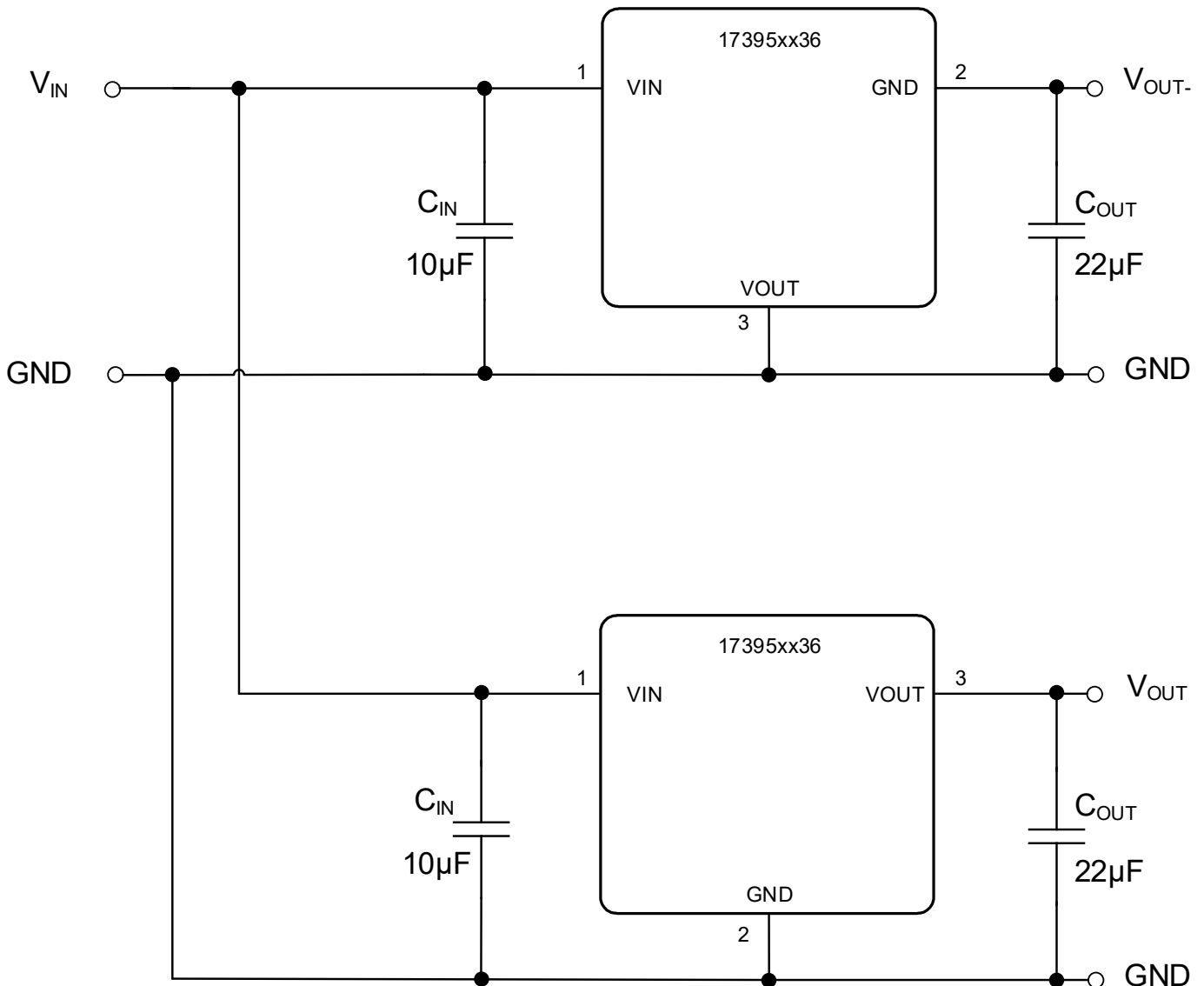

Complementary Output Voltage

WAVE SOLDER PROFILE

Profile Feature	Old standard (Pb)	New (Pb-free)
Time within peak temperature t_p	10s	10s
Average ramp-up rate	200 °C/s	200 °C/s
Final preheat temperature T_s	130 °C/s	130 °C/s
Peak temperature T_p	+235 °C/s	+260 °C/s
Ramp-down rate	-5 °C/s	-5 °C/s
Heating rate during preheat	4 °C/s	4 °C/s

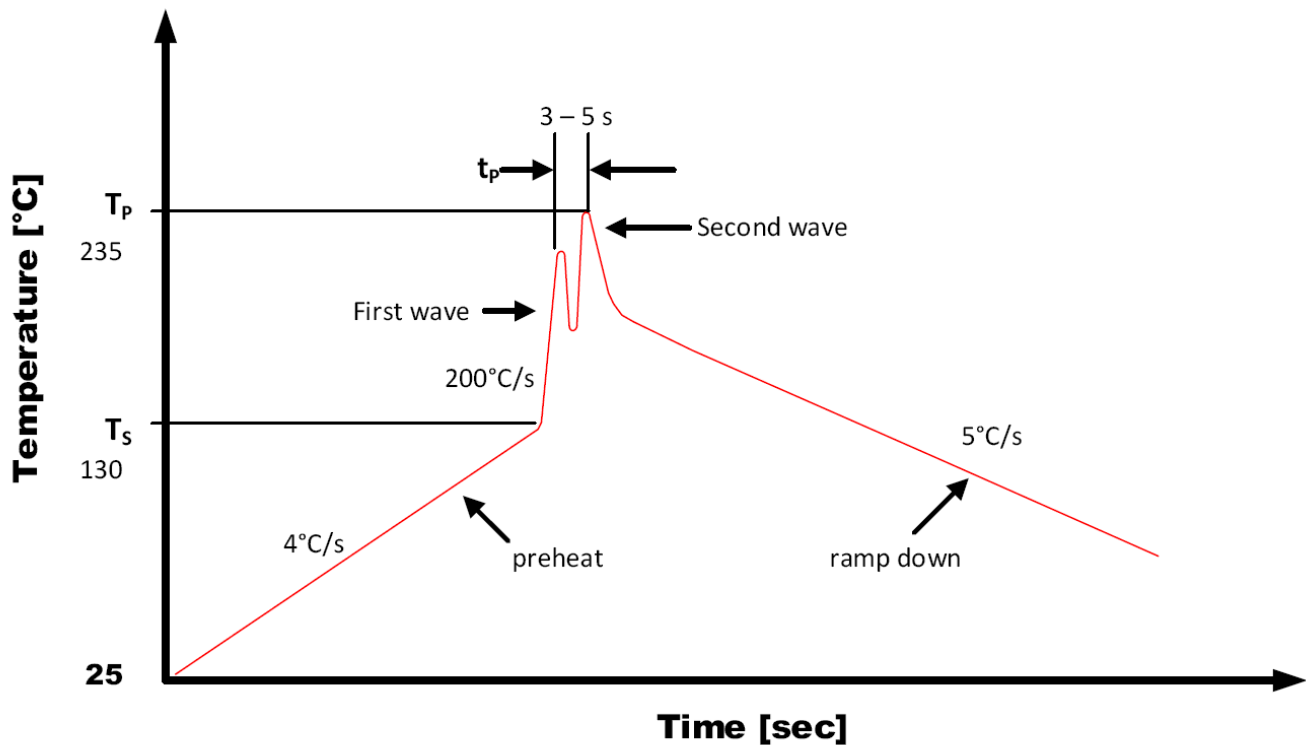
Wave Solder Diagram:

PHYSICAL DIMENSIONS

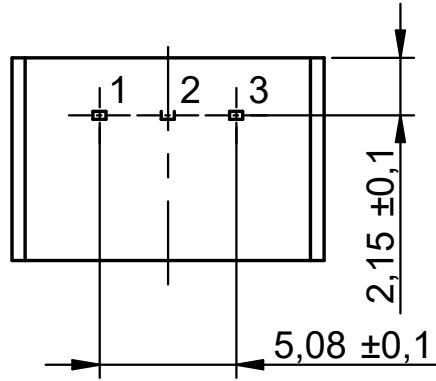

Bottom view

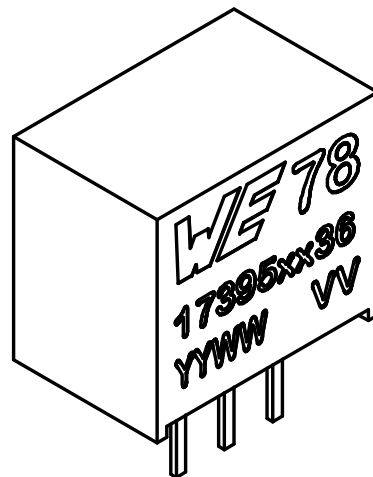
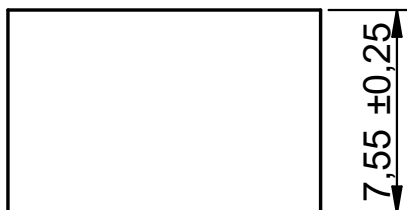
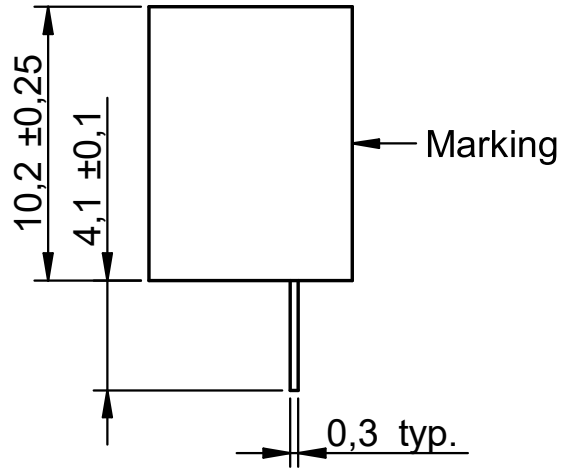
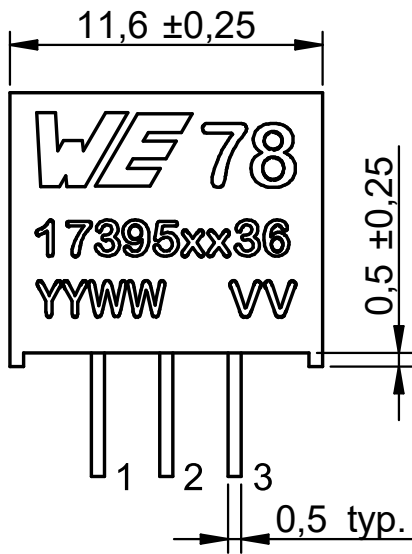

All dimensions in mm
Tolerances $\pm 0,1$ mm unless otherwise specified

RECOMMENDED DRILL HOLES

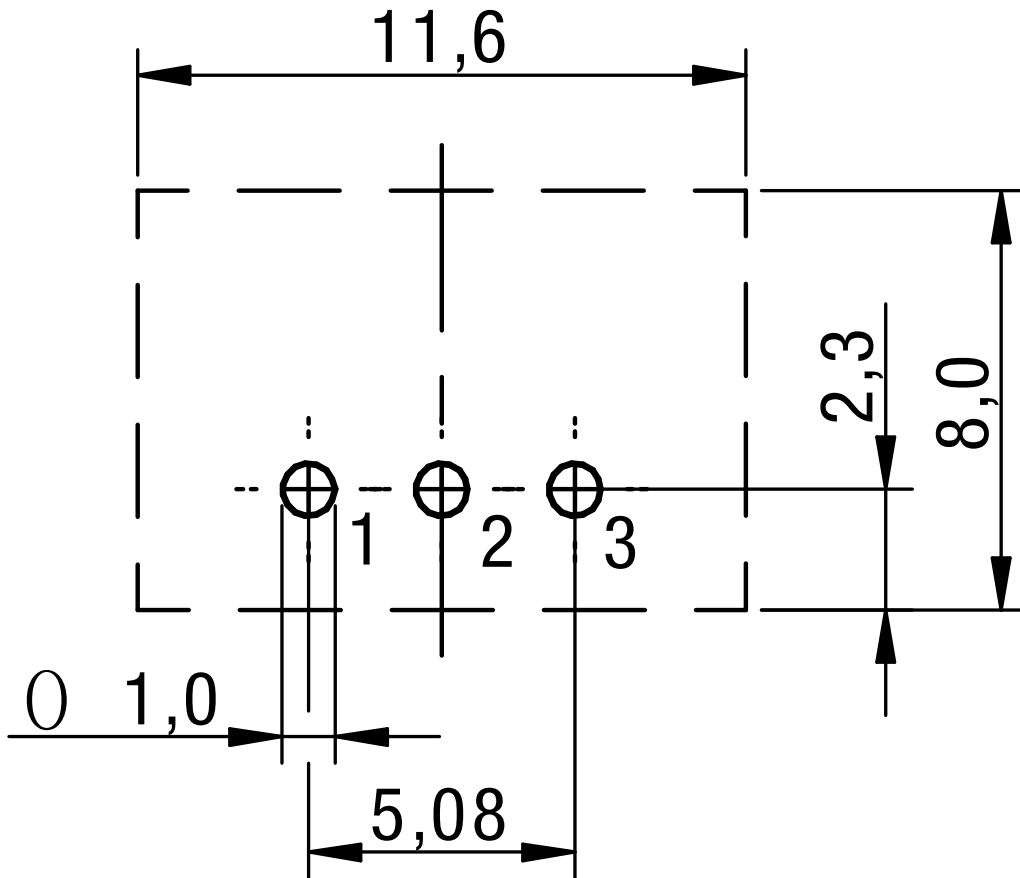

All dimension in mm

17395xx36

MagI³C Power Module

WPME-FDSM - Fixed Step Down Regulator Module



**WÜRTH
ELEKTRONIK**
MORE THAN
YOU EXPECT

DOCUMENT HISTORY

Revision	Date	Description	Comment
1.0	May 2019	Initial data sheet release	
2.0	September 2021	Added 173951236 and 173951536 family members	

CAUTIONS AND WARNINGS

The following conditions apply to all goods within the product series of MagI³C of Würth Elektronik eiSos GmbH & Co. KG:

General:

- All recommendations according to the general technical specifications of the data-sheet have to be complied with.
- The usage and operation of the product within ambient conditions which probably alloy or harm the component surface has to be avoided.
- Electronic components that will be used in safety-critical or high-reliability applications, should be pre-evaluated by the customer.
- The component is designed and manufactured to be used within the datasheet specified values. If the usage and operation conditions specified in the datasheet are not met, the component may be damaged or dissolved.
- Do not drop or impact the components as material of the body, pins or termination may flake apart.
- Würth Elektronik eiSos products are qualified according to international standards, which are listed in each product reliability report. Würth Elektronik eiSos does not warrant any customer qualified product characteristics beyond Würth Elektronik eiSos's specifications, for its validity and sustainability over time.
- The responsibility for the applicability of the customer specific products and use in a particular customer design is always within the authority of the customer. All technical specifications for standard products also apply to customer specific products.
- Customer acknowledges and agrees that it is solely responsible for compliance with all legal, regulatory and safety-related requirements concerning its products, and any use of Würth Elektronik eiSos GmbH & Co. KG components in its applications, notwithstanding any applications-related information or support that may be provided by Würth Elektronik eiSos GmbH & Co. KG. Customer represents and agrees that it has all the necessary expertise to create and implement safeguards which anticipate dangerous consequences of failures, monitor failures and their consequences lessen the likelihood of failures that might cause harm and take appropriate remedial actions. Customer will fully indemnify Würth Elektronik eiSos and its representatives against any damages arising out of the use of any Würth Elektronik eiSos GmbH & Co. KG components in safety-critical applications.

Product specific:

It has to be clearly pointed out that the possibility of a malfunction of electronic components or failure before the end of the usual lifetime cannot be completely eliminated in the current state of the art, even if the products are operated within the range of the specifications. The same statement is valid for all software sourcecode and firmware parts contained in or used with or for products in the wireless connectivity and sensor product range of Würth Elektronik eiSos GmbH & Co. KG. In certain customer applications requiring a high level of safety and especially in customer applications in which the malfunction or failure of an electronic component could endanger human life or health, it must be ensured by most advanced technological aid of suitable design of the customer application that no injury or damage is caused to third parties in the event of malfunction or failure of an electronic component.

DISCLAIMER

This electronic component has been designed and developed for usage in general electronic equipment only. This product is not authorized for use in equipment where a higher safety standard and reliability standard is especially required or where a failure of the product is reasonably expected to cause severe personal injury or death, unless the parties have executed an agreement specifically governing such use. Moreover Würth Elektronik eiSos GmbH & Co. KG products are neither designed nor intended for use in areas such as military, aerospace, aviation, nuclear control, submarine, transportation (automotive control, train control, ship control), transportation signal, disaster prevention, medical, public information network etc. Würth Elektronik eiSos GmbH & Co. KG must be informed about the intent of such usage before the design-in stage. In addition, sufficient reliability evaluation checks for safety must be performed on every electronic component which is used in electrical circuits that require high safety and reliability functions or performance.

These cautions and warnings comply with the state of the scientific and technical knowledge and are believed to be accurate and reliable. However, no responsibility is assumed for inaccuracies or incompleteness.

B IMPORTANT NOTES

The following conditions apply to all goods within the product range of Würth Elektronik eiSos GmbH & Co. KG:

1. General Customer Responsibility

Some goods within the product range of Würth Elektronik eiSos GmbH & Co. KG contain statements regarding general suitability for certain application areas. These statements about suitability are based on our knowledge and experience of typical requirements concerning the areas, serve as general guidance and cannot be estimated as binding statements about the suitability for a customer application. The responsibility for the applicability and use in a particular customer design is always solely within the authority of the customer. Due to this fact it is up to the customer to evaluate, where appropriate to investigate and decide whether the device with the specific product characteristics described in the product specification is valid and suitable for the respective customer application or not. Accordingly, the customer is cautioned to verify that the datasheet is current before placing orders.

2. Customer Responsibility Related to Specific, in Particular Safety-Relevant, Applications

It has to be clearly pointed out that the possibility of a malfunction of electronic components or failure before the end of the usual lifetime cannot be completely eliminated in the current state of the art, even if the products are operated within the range of the specifications. In certain customer applications requiring a very high level of safety and especially in customer applications in which the malfunction or failure of an electronic component could endanger human life or health it must be ensured by most advanced technological aid of suitable design of the customer application that no injury or damage is caused to third parties in the event of malfunction or failure of an electronic component.

3. Best Care and Attention

Any product-specific notes, warnings and cautions must be strictly observed. Any disregard will result in the loss of warranty.

4. Customer Support for Product Specifications

Some products within the product range may contain substances which are subject to restrictions in certain jurisdictions in order to serve specific technical requirements. Necessary information is available on request. In this case the field sales engineer or the internal sales person in charge should be contacted who will be happy to support in this matter.

5. Product R&D

Due to constant product improvement product specifications may change from time to time. As a standard reporting procedure of the Product Change Notification (PCN) according to the JEDEC-Standard we inform about minor and major changes. In case of further queries regarding the PCN, the field sales engineer or the internal sales person in charge should be contacted. The basic responsibility of the customer as per Section 1 and 2 remains unaffected.

6. Product Life Cycle

Due to technical progress and economical evaluation we also reserve the right to discontinue production and delivery of products. As a standard reporting procedure of the Product Termination Notification (PTN) according to the JEDEC-Standard we will inform at an early stage about inevitable product discontinuance. According to this we cannot guarantee that all products within our product range will always be available. Therefore it needs to be verified with the field sales engineer or the internal sales person in charge about the current product availability expectancy before or when the product for application design-in disposal is considered. The approach named above does not apply in the case of individual agreements deviating from the foregoing for customer-specific products.

7. Property Rights

All the rights for contractual products produced by Würth Elektronik eiSos GmbH & Co. KG on the basis of ideas, development contracts as well as models or templates that are subject to copyright, patent or commercial protection supplied to the customer will remain with Würth Elektronik eiSos GmbH & Co. KG. Würth Elektronik eiSos GmbH & Co. KG does not warrant or represent that any license, either expressed or implied, is granted under any patent right, copyright, mask work right, or other intellectual property right relating to any combination, application, or process in which Würth Elektronik eiSos GmbH & Co. KG components or services are used.

8. General Terms and Conditions

Unless otherwise agreed in individual contracts, all orders are subject to the current version of the "General Terms and Conditions of Würth Elektronik eiSos Group", last version available at www.we-online.com.

X-ON Electronics

Largest Supplier of Electrical and Electronic Components

Click to view similar products for [Non-Isolated DC/DC Converters](#) category:

Click to view products by [Würth](#) manufacturer:

Other Similar products are found below :

[PSR152.5-7IR](#) [APTH003A0X-SRZ](#) [SPM1004-3V3C](#) [R-785.0-05](#) [10E24-P15-10PPM](#) [1E24-P4-25PPM-SHV-5KV](#) [PROPOWER-3.3V](#)
[MYGTM01210BZN](#) [40C24-N250-I5-H](#) [40A24-P30-E](#) [3V12-P0.8](#) [10C24-N250-I10-AQ-DA](#) [4AA24-P20-M-H](#) [3V12-N0.8](#) [3V24-P1](#) [3V24-](#)
[N1](#) [BMR4672010/001](#) [BMR4652010/001](#) [6AA24-P30-I5-M](#) [6AA24-N30-I5-M](#) [BM2P101X-Z](#) [35A24-P30](#) [2.5M24-P1](#) [PTV03010WAD](#)
[PTV05020WAH](#) [PTV12010LAH](#) [PTV12020WAD](#) [R-7212D](#) [R-7212P](#) [R-78AA15-0.5SMD](#) [R-78AA5.0-1.0SMD](#) [30A24-N15-E](#) [10A12-P4-](#)
[M](#) [10C24-N250-I5](#) [10C24-P125](#) [10C24-P250-I5](#) [6A24-P20-I10-F-M-25PPM](#) [1A24-P30-F-M-C](#) [TSR 1-24150SM](#) [1/2AA24-N30-I10](#) [1C24-](#)
[N125](#) [12C24-N250](#) [V7806-1500](#) [PTV12020LAH](#) [PTV05010WAH](#) [PTN04050CAZT](#) [PTH12020WAD](#) [PTH12020LAS](#) [PTH05050YAH](#)
[PTH05T210WAH](#)