

**Dimensions: [mm]**

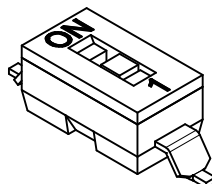

Scale - 3,5:1

**Recommended Land Pattern: [mm]**

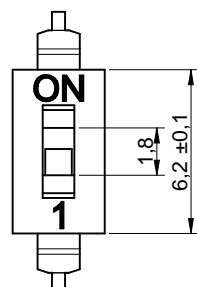
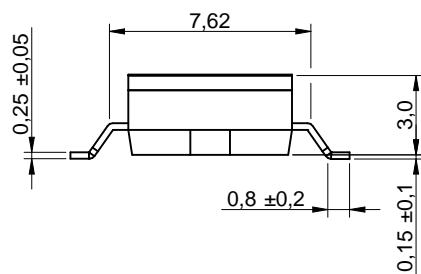
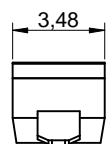
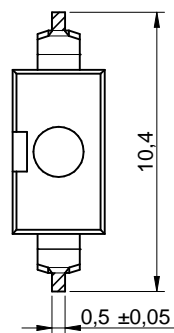
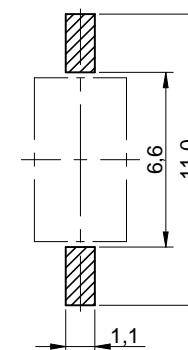

Scale - 3,5:1

**Schematic:**



**Dimensions:**

Properties		Value	Unit
Poles		1	
Length	L	3.48	mm

	CHECKED	REVISION	DATE (YYYY-MM-DD)	GENERAL TOLERANCE	PROJECTION METHOD
	ICb	001.001	2019-04-10	DIN ISO 2768-1m	
	DESCRIPTION <b>WS-DISV Small Compact SMT Dip Switch</b>				ORDER CODE
					<b>418121160801</b>
SIZE/TYPE			BUSINESS UNIT	STATUS	PAGE
Flat Actuator with top tape, 2.54 mm			eiCan	Valid	1/7
Würth Elektronik eiSos GmbH & Co. KG EMC & Inductive Solutions Max-Eyth-Str. 1 74638 Waldenburg Germany Tel. +49 (0) 79 42 945 - 0 www.we-online.com eiSos@we-online.com					

This electronic component has been designed and developed for usage in general electronic equipment only. This product is not authorized for use in equipment where a higher safety standard and reliability standard is especially required or where a failure of the product is reasonably expected to cause severe personal injury or death, unless the parties have executed an agreement specifically governing such use. Moreover Würth Elektronik eiSos GmbH & Co KG products are neither designed nor intended for use in areas such as military, aerospace, aviation, nuclear control, submarine, transportation (automotive control, train control, ship control), transportation signal, disaster prevention, medical, public information network etc.. Würth Elektronik eiSos GmbH & Co KG must be informed about the intent of such usage before the design-in stage. In addition, sufficient reliability evaluation checks for safety must be performed on every electronic component which is used in electrical circuits that require high safety and reliability functions or performance.

## Material Properties:

Cover Material	PA9T
Cover Flammability Rating	UL94 V-0
Cover Color	Black
Base Material	PA9T
Base Flammability Rating	UL94 V-0
Base Color	Black
Actuator Material	PA46
Actuator Flammability Rating	UL94 V-0
Actuator Color	White
Contact Material	Copper Alloy
Contact Plating	Gold
Terminal Material	Copper Alloy
Terminal Plating	Gold
Tape Type	Polyimide

## Electrical Properties:

Properties	Test conditions	Value	Unit	Tol.
Rated Current Switching	$I_R$	25	mA	
Rated Voltage Switching	$V_R$	24	V (DC)	
Rated Current Non-Switching	$I_R$	100	mA	
Rated Voltage Non-Switching	$V_R$	50	V (DC)	
Contact Resistance Initial	R	50	m $\Omega$	max.
Contact Resistance After Life Test	R	100	m $\Omega$	max.
Insulation Resistance	$R_{ISO}$ 500 V (DC)	100	M $\Omega$	min.
Withstanding Voltage	1 min	500	V (AC)	

## Mechanical Properties:

Properties	Test conditions	Value	Unit	Tol.
Operation Force		600	g	max.
Electrical Life <sup>1)</sup>	25 mA / 24 V (DC)	2000	Times	
Mechanical Life <sup>2)</sup>		2000	Times	min.
Actuator Type	Flat Type			
Switch Position	Off			

<sup>1)</sup> Times: switching method from OFF-ON-OFF counted as 1 time

<sup>2)</sup> Times: switching method from OFF-ON-OFF counted as 1 time

## General Information:



Operating Temperature	-40 up to +85 °C
Storage Conditions (in original packaging)	< 40 °C ; < 75 % RH
Moisture Sensitivity Level (MSL)	1
Washable	Yes

## Packaging Properties:

Packaging	Tape and Reel
-----------	---------------

## Certification:

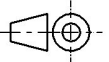
RoHS Approval	Compliant [ 2011/65/EU&2015/863 ]
REACH Approval	Conform or declared [ (EC)1907/2006 ]
Halogen Free	Conform [ JEDEC JS709B ]

	CHECKED	REVISION	DATE (YYYY-MM-DD)	GENERAL TOLERANCE	PROJECTION METHOD
	ICb	001.001	2019-04-10	DIN ISO 2768-1m	
	DESCRIPTION				ORDER CODE
	<b>WS-DISV Small Compact SMT Dip Switch</b>				<b>418121160801</b>
	SIZE/TYPE	BUSINESS UNIT	STATUS	PAGE	
	Flat Actuator with top tape, 2.54 mm	eiCan	Valid	2/7	

This electronic component has been designed and developed for usage in general electronic equipment only. This product is not authorized for use in equipment where a higher safety standard and reliability standard is especially required or where a failure of the product is reasonably expected to cause severe personal injury or death, unless the parties have executed an agreement specifically governing such use. Moreover Würth Elektronik eiSos GmbH & Co KG products are neither designed nor intended for use in areas such as military, aerospace, aviation, nuclear control, submarine, transportation (automotive control, train control, ship control), transportation signal, disaster prevention, medical, public information network etc.. Würth Elektronik eiSos GmbH & Co KG must be informed about the intent of such usage before the design-in stage. In addition, sufficient reliability evaluation checks for safety must be performed on every electronic component which is used in electrical circuits that require high safety and reliability functions or performance.

# Packaging Specification - Tape and Reel: [mm]

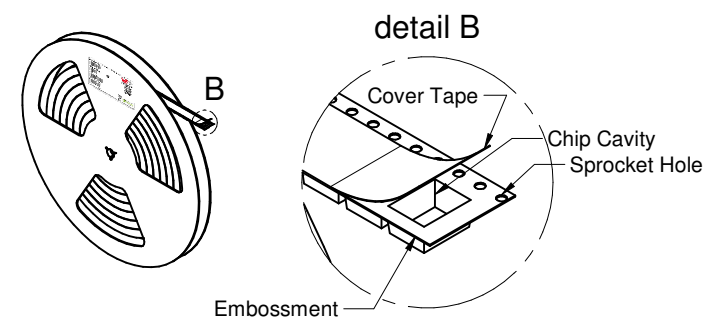
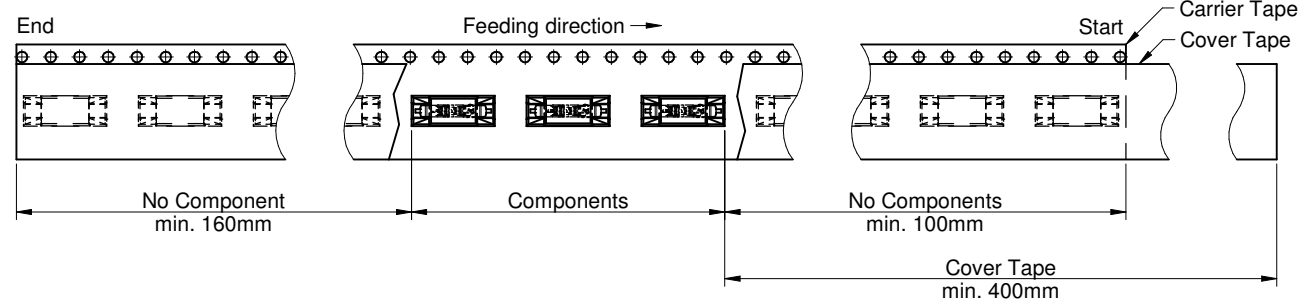
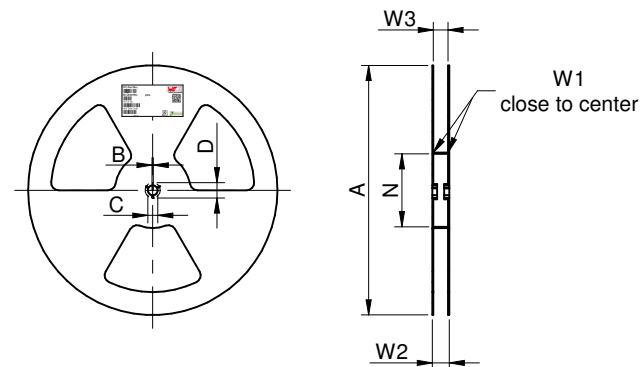
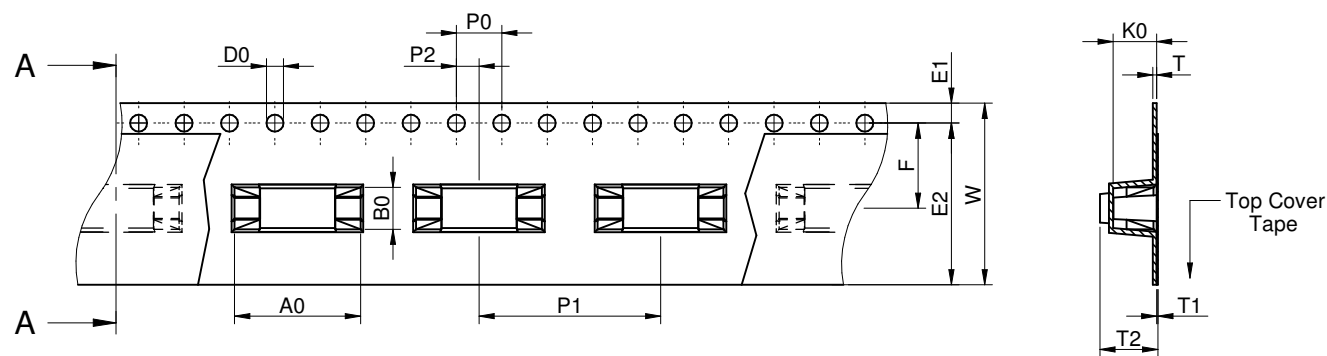

Tape Type	A0 (mm)	B0 (mm)	W (mm)	T (mm)	T1 (mm)	T2 (mm)	K0 (mm)	P0 (mm)	P1 (mm)	P2 (mm)	D0 (mm)	E1 (mm)	E2 (mm)	F (mm)	Material	Qty. (pcs.)
2a	typ.	typ.	±0.3	ref.	ref.	typ.	typ.	±0.1	±0.1	±0.1	+0.1/-0.0	±0.1	min.	±0.1	Polystyrene	800
	10.90	3.50	16.00	0.35	0.10	4.85	4.65	4.00	16.00	2.00	1.50	1.75	14.25	7.50		

A (mm)	B (mm)	C (mm)	D (mm)	N (mm)	W1 (mm)	W2 (mm)	W3 (mm)	W3 (mm)	Material
± 2.0	min.	min.	min.	min.	+ 2.0	max.	min.	max.	Polystyrene/ Polyurethane
330,00	1,50	12,80	20,20	60,00	16,40	22,40	15,90	19,40	

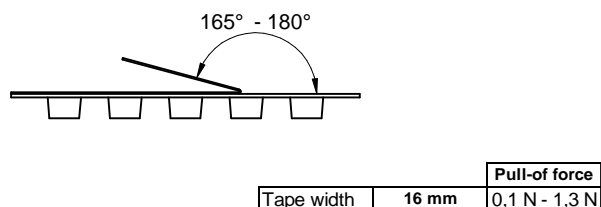

	CHECKED	REVISION	DATE (YYYY-MM-DD)	GENERAL TOLERANCE	PROJECTION METHOD
	ICb	001.001	2019-04-10	DIN ISO 2768-1m	
	DESCRIPTION				ORDER CODE
	<b>WS-DISV Small Compact SMT Dip Switch</b>				<b>418121160801</b>
SIZE/TYPE			BUSINESS UNIT	STATUS	PAGE
Flat Actuator with top tape, 2.54 mm			eiCan	Valid	3/7
Würth Elektronik eiSos GmbH & Co. KG EMC & Inductive Solutions Max-Eyth-Str. 1 74638 Waldenburg Germany Tel. +49 (0) 79 42 945 - 0 www.we-online.com eiSos@we-online.com					

This electronic component has been designed and developed for usage in general electronic equipment only. This product is not authorized for use in equipment where a higher safety standard and reliability standard is especially required or where a failure of the product is reasonably expected to cause severe personal injury or death, unless the parties have executed an agreement specifically governing such use. Moreover Würth Elektronik eiSos GmbH & Co KG products are neither designed nor intended for use in areas such as military, aerospace, aviation, nuclear control, submarine, transportation (automotive control, train control, ship control), transportation signal, disaster prevention, medical, public information network etc.. Würth Elektronik eiSos GmbH & Co KG must be informed about the intent of such usage before the design-in stage. In addition, sufficient reliability evaluation checks for safety must be performed on every electronic component which is used in electrical circuits that require high safety and reliability functions or performance.

### Classification Reflow Profile for SMT components:



### Classification Reflow Soldering Profile:

Profile Feature		Value
Preheat Temperature Min <sup>1)</sup>	T <sub>s min</sub>	150 °C
Preheat Temperature Max	T <sub>s max</sub>	200 °C
Preheat Time t <sub>s</sub> from T <sub>s min</sub> to T <sub>s max</sub>	t <sub>s</sub>	60 - 120 seconds
Ramp-up Rate (T <sub>L</sub> to T <sub>p</sub> )		3 °C/ second max.
Liquidous Temperature	T <sub>L</sub>	217 °C
Time t <sub>L</sub> maintained above T <sub>L</sub>	t <sub>L</sub>	60 - 150 seconds
Peak package body temperature	T <sub>p</sub>	see table
Time within 5°C of actual peak temperature	t <sub>p</sub>	20 - 30 seconds
Ramp-down Rate (T <sub>L</sub> to T <sub>p</sub> )		6 °C/ second max.
Time 25°C to peak temperature		8 minutes max.

<sup>1)</sup> refer to IPC/JEDEC J-STD-020D  
refer to IPC/ JEDEC J-STD-020E

### Package Classification Reflow Temperature:

Properties	Volume mm <sup>3</sup> <350	Volume mm <sup>3</sup> 350-2000	Volume mm <sup>3</sup> >2000
PB-Free Assembly   Package Thickness < 1.6 mm <sup>1)</sup>	260 °C	260 °C	260 °C
PB-Free Assembly   Package Thickness 1.6 mm - 2.5 mm	260 °C	250 °C	245 °C
PB-Free Assembly   Package Thickness ≥ 2.5 mm	250 °C	245 °C	245 °C

<sup>1)</sup> refer to IPC/JEDEC J-STD-020D  
refer to IPC/ JEDEC J-STD-020E

	CHECKED	REVISION	DATE (YYYY-MM-DD)	GENERAL TOLERANCE	PROJECTION METHOD
	ICh	001.001	2019-04-10	DIN ISO 2768-1m	
	DESCRIPTION				ORDER CODE
	<b>WS-DISV Small Compact SMT Dip Switch</b>				<b>418121160801</b>
	SIZE/TYPE	BUSINESS UNIT	STATUS	PAGE	
	Flat Actuator with top tape, 2.54 mm	eiCan	Valid	4/7	

This electronic component has been designed and developed for usage in general electronic equipment only. This product is not authorized for use in equipment where a higher safety standard and reliability standard is especially required or where a failure of the product is reasonably expected to cause severe personal injury or death, unless the parties have executed an agreement specifically governing such use. Moreover Würth Elektronik eiSos GmbH & Co KG products are neither designed nor intended for use in areas such as military, aerospace, aviation, nuclear control, submarine, transportation (automotive control, train control, ship control), transportation signal, disaster prevention, medical, public information network etc.. Würth Elektronik eiSos GmbH & Co KG must be informed about the intent of such usage before the design-in stage. In addition, sufficient reliability evaluation checks for safety must be performed on every electronic component which is used in electrical circuits that require high safety and reliability functions or performance.

## Cautions and Warnings:

### The following conditions apply to all goods within the product series of Dip switch of Würth Elektronik eiSos GmbH & Co. KG:

#### General:

- This mechanical component is designed and manufactured for use in general electronic equipment.
- Würth Elektronik must be asked for written approval (following the PPAP procedure) before incorporating the components into any equipment in fields such as military, aerospace, aviation, nuclear control, submarine, transportation (automotive control, train control, ship control), transportation signal, disaster prevention, medical, public information network, etc. where higher safety and reliability are especially required and/or if there is the possibility of direct damage or human injury.
- Mechanical components that will be used in safety-critical or high-reliability applications, should be pre-evaluated by the customer.
- The component is designed and manufactured to be used within the datasheet specified values. If the usage and operation conditions specified in the datasheet are not met, the component may be damaged or dissolved.
- Do not drop or impact the components, as the switch, pins or termination may flake apart.
- Prevent any damage or scratches on the switch, especially on the actuator.
- Würth Elektronik products are qualified according to international standards, which are listed in each product reliability report. Würth Elektronik does not warrant any customer qualified product characteristics beyond Würth Elektronik's specifications, for its validity and sustainability over time.
- The responsibility for the applicability of the customer specific products and use in a particular customer design is always within the authority of the customer. All technical specifications for standard products also apply to customer specific products.

#### Product specific:

##### Soldering:

- The solder profile must comply with the Würth Elektronik technical soldering specification. All other profiles will void the warranty.
- A maximum of two reflow cycles are recommended.
- All other soldering methods are at the customers' own risk.

##### Cleaning and Washing:

- If a series is washable, the general information section in the datasheet will contain the washability guidelines. Should there be no information regarding washability, the product has not been constructed to withstand a washing process. Washing agents used during the production to clean the customer application might damage or change the characteristics of the component, body, pins and/or termination. Washing agents may have a negative effect on the long-term functionality of the product.

If the parts are washable, hermetic:

- Cleaning agents that are used to clean the customer applications may damage or change the characteristics of the component, body, pins and termination.
- Please do not immerse any washable products into water or cleaning agents or put them in locations exposed to water completely.
- Do not clean washable series immediately after soldering. The cleaning agent may be absorbed into the switch through respiration while the switch cools.
- Please do not press actuator or change status /position during the cleaning and washing process.
- Using a brush during the cleaning process may deform function relevant areas. Therefore, we do not recommend using a brush during the PCB cleaning process.

##### Potting and Coating:

- If the product is potted in the customer application, the potting material may shrink or expand during and after hardening. Shrinking could lead to an incomplete seal, allowing contaminants into the body, pins or termination. Expansion could damage body, pins or termination. We recommend a manual inspection after potting or coating to avoid these effects.



#### Storage Conditions:

- A storage of Würth Elektronik products for longer than 12 months is not recommended. Within other effects, the terminals may suffer degradation, resulting in bad solderability. Therefore, all products shall be used within the period of 12 months based on the day of shipment.
- Do not expose the components to direct sunlight.
- The storage conditions in the original packaging are defined according to DIN EN 61760-2.
- For a moisture sensitive component, the storage condition in the original packaging is defined according to IPC/JEDEC-J-STD-033. It is also recommended to return the component to the original moisture proof bag and reseal the moisture proof bag again.

#### Handling:

- Do not repeatedly operate the switch with excessive force. It may damage or deform the switch resulting in malfunction.
- Design the right angle part with consideration of the wave soldering process so that the parts will not touch the soldering wave during the soldering process or protect the switch part with cover fixture. Melting of the switch may cause malfunction.
- In the case a product requires particular handling precautions in addition to those mentioned in this text, these will appear on the product datasheet.
- For series with top tape, the tape is to be removed after the manufacturing process is completed at customer side.
- A ball pen or plastic tweezers with flat and smooth surface (the latter is recommended to be used to switch the actuator position). Please do not apply excessive force as it could damage or deform the contacts inside the switch and this may lead to malfunction of the switch.
- Do not use sharp headed tools to operate the switch. Sharp headed tools may damage the switch surface and may result in malfunction of the switch.

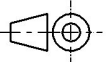
Correct setting steps:



	CHECKED ICh	REVISION 001.001	DATE (YYYY-MM-DD) 2019-04-10	GENERAL TOLERANCE DIN ISO 2768-1m	PROJECTION METHOD 		
	DESCRIPTION <b>WS-DISV Small Compact SMT Dip Switch</b>				ORDER CODE <b>418121160801</b>		
	Würth Elektronik eiSos GmbH & Co. KG EMC & Inductive Solutions Max-Eyth-Str. 1 74638 Waldenburg Germany Tel. +49 (0) 79 42 945 - 0 www.we-online.com eiSos@we-online.com			SIZE/TYPE Flat Actuator with top tape, 2.54 mm	BUSINESS UNIT eiCan	STATUS Valid	PAGE 5/7
	This electronic component has been designed and developed for usage in general electronic equipment only. This product is not authorized for use in equipment where a higher safety standard and reliability standard is especially required or where a failure of the product is reasonably expected to cause severe personal injury or death, unless the parties have executed an agreement specifically governing such use. Moreover Würth Elektronik eiSos GmbH & Co KG products are neither designed nor intended for use in areas such as military, aerospace, aviation, nuclear control, submarine, transportation (automotive control, train control, ship control), transportation signal, disaster prevention, medical, public information network etc.. Würth Elektronik eiSos GmbH & Co KG must be informed about the intent of such usage before the design-in stage. In addition, sufficient reliability evaluation checks for safety must be performed on every electronic component which is used in electrical circuits that require high safety and reliability functions or performance.						

1. For the top-tapped DIP switches, do not remove the tape until the soldering process is completed.
2. Fix one side of the tweezers to hold the one side of switch cover and the other side of tweezers to hold the moveable actuator in vertical direction.
3. Using slide force to change the setting from ON to OFF or OFF to ON.

Please follow the aforementioned 'Correct setting steps' and do not use the closed-lever tweezers to push or poke the actuator. Extensive and unbalanced force may damage or deform the contacts and/or the slide window, thus undesirable failures may occur.

Please do not switch the setting to 'On' or 'Off' until the PCB is fully cooled down.

These cautions and warnings comply with the state of the scientific and technical knowledge and are believed to be accurate and reliable. However, no responsibility is assumed for inaccuracies or incompleteness.

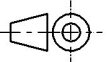
 	CHECKED ICh	REVISION 001.001	DATE (YYYY-MM-DD) 2019-04-10	GENERAL TOLERANCE DIN ISO 2768-1m	PROJECTION METHOD 
	DESCRIPTION <b>WS-DISV Small Compact SMT Dip Switch</b>				ORDER CODE <b>418121160801</b>
	SIZE/TYPE Flat Actuator with top tape, 2.54 mm	BUSINESS UNIT eiCan	STATUS Valid	PAGE 6/7	

This electronic component has been designed and developed for usage in general electronic equipment only. This product is not authorized for use in equipment where a higher safety standard and reliability standard is especially required or where a failure of the product is reasonably expected to cause severe personal injury or death, unless the parties have executed an agreement specifically governing such use. Moreover Würth Elektronik eiSos GmbH & Co KG products are neither designed nor intended for use in areas such as military, aerospace, aviation, nuclear control, submarine, transportation (automotive control, train control, ship control), transportation signal, disaster prevention, medical, public information network etc.. Würth Elektronik eiSos GmbH & Co KG must be informed about the intent of such usage before the design-in stage. In addition, sufficient reliability evaluation checks for safety must be performed on every electronic component which is used in electrical circuits that require high safety and reliability functions or performance.

## Important Notes

The following conditions apply to all goods within the product range of Würth Elektronik eiSos GmbH & Co. KG:

### 1. General Customer Responsibility

Some goods within the product range of Würth Elektronik eiSos GmbH & Co. KG contain statements regarding general suitability for certain application areas. These statements about suitability are based on our knowledge and experience of typical requirements concerning the areas, serve as general guidance and cannot be estimated as binding statements about the suitability for a customer application. The responsibility for the applicability and use in a particular customer design is always solely within the authority of the customer. Due to this fact it is up to the customer to evaluate, where appropriate to investigate and decide whether the device with the specific product characteristics described in the product specification is valid and suitable for the respective customer application or not.

### 2. Customer Responsibility related to Specific, in particular Safety-Relevant Applications

It has to be clearly pointed out that the possibility of a malfunction of electronic components or failure before the end of the usual lifetime cannot be completely eliminated in the current state of the art, even if the products are operated within the range of the specifications. In certain customer applications requiring a very high level of safety and especially in customer applications in which the malfunction or failure of an electronic component could endanger human life or health it must be ensured by most advanced technological aid of suitable design of the customer application that no injury or damage is caused to third parties in the event of malfunction or failure of an electronic component. Therefore, customer is cautioned to verify that data sheets are current before placing orders. The current data sheets can be downloaded at [www.we-online.com](http://www.we-online.com).

### 3. Best Care and Attention

Any product-specific notes, cautions and warnings must be strictly observed. Any disregard will result in the loss of warranty.

### 4. Customer Support for Product Specifications

Some products within the product range may contain substances which are subject to restrictions in certain jurisdictions in order to serve specific technical requirements. Necessary information is available on request. In this case the field sales engineer or the internal sales person in charge should be contacted who will be happy to support in this matter.

### 5. Product R&D

Due to constant product improvement product specifications may change from time to time. As a standard reporting procedure of the Product Change Notification (PCN) according to the JEDEC-Standard inform about minor and major changes. In case of further queries regarding the PCN, the field sales engineer or the internal sales person in charge should be contacted. The basic responsibility of the customer as per Section 1 and 2 remains unaffected.

### 6. Product Life Cycle

Due to technical progress and economical evaluation we also reserve the right to discontinue production and delivery of products. As a standard reporting procedure of the Product Termination Notification (PTN) according to the JEDEC-Standard we will inform at an early stage about inevitable product discontinuance. According to this we cannot guarantee that all products within our product range will always be available. Therefore it needs to be verified with the field sales engineer or the internal sales person in charge about the current product availability expectancy before or when the product for application design-in disposal is considered. The approach named above does not apply in the case of individual agreements deviating from the foregoing for customer-specific products.

### 7. Property Rights

All the rights for contractual products produced by Würth Elektronik eiSos GmbH & Co. KG on the basis of ideas, development contracts as well as models or templates that are subject to copyright, patent or commercial protection supplied to the customer will remain with Würth Elektronik eiSos GmbH & Co. KG. Würth Elektronik eiSos GmbH & Co. KG does not warrant or represent that any license, either expressed or implied, is granted under any patent right, copyright, mask work right, or other intellectual property right relating to any combination, application, or process in which Würth Elektronik eiSos GmbH & Co. KG components or services are used.

### 8. General Terms and Conditions

Unless otherwise agreed in individual contracts, all orders are subject to the current version of the "General Terms and Conditions of Würth Elektronik eiSos Group", last version available at [www.we-online.com](http://www.we-online.com).

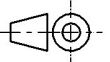
 <b>WE</b> <b>WÜRTH ELEKTRONIK</b>	CHECKED ICh	REVISION 001.001	DATE (YYYY-MM-DD) 2019-04-10	GENERAL TOLERANCE DIN ISO 2768-1m	PROJECTION METHOD 
	DESCRIPTION <b>WS-DISV Small Compact SMT Dip Switch</b>				ORDER CODE <b>418121160801</b>
WÜRTH ELEKTRONIK eiSos GmbH & Co. KG EMC & Inductive Solutions Max-Eyth-Str. 1 74638 Waldenburg Germany Tel. +49 (0) 79 42 945 - 0 www.we-online.com eiSos@we-online.com	SIZE/TYPE Flat Actuator with top tape, 2.54 mm	BUSINESS UNIT eiCan	STATUS Valid	PAGE 7/7	

This electronic component has been designed and developed for usage in general electronic equipment only. This product is not authorized for use in equipment where a higher safety standard and reliability standard is especially required or where a failure of the product is reasonably expected to cause severe personal injury or death, unless the parties have executed an agreement specifically governing such use. Moreover Würth Elektronik eiSos GmbH & Co KG products are neither designed nor intended for use in areas such as military, aerospace, aviation, nuclear control, submarine, transportation (automotive control, train control, ship control), transportation signal, disaster prevention, medical, public information network etc.. Würth Elektronik eiSos GmbH & Co KG must be informed about the intent of such usage before the design-in stage. In addition, sufficient reliability evaluation checks for safety must be performed on every electronic component which is used in electrical circuits that require high safety and reliability functions or performance.

## X-ON Electronics

Largest Supplier of Electrical and Electronic Components

*Click to view similar products for [DIP Switches/SIP Switches](#) category:*

*Click to view products by [Wurth](#) manufacturer:*

Other Similar products are found below :

[78M03S](#) [79B10T](#) [8136-475G4T](#) [G7G-1A2-CB-DC12](#) [H7CZL8AC100240](#) [A7SS-M](#) [A8CA-201](#) [DRR60016](#) [DRS4016](#) [1825008-1](#) [1825444-1](#) [25.350.0653.0](#) [SDA10H1BDA](#) [97R06ST](#) [A2C-2A5](#) [1825444-7](#) [ADE08SA04](#) [ADE12S04](#) [192960010](#) [2-1825058-8](#) [25.330.0653.1](#) [25.352.0353.0](#) [CXDRIVEV2X](#) [IKN0600000](#) [IKN0800000](#) [LA2-002-DC24](#) [DBS1003](#) [438872000](#) [DRD10CRAE04](#) [DSR02T](#) [DSS 208 N](#) [E2FMX2D1M1TGJ03M](#) [NDI10H](#) [219-9MSTP](#) [204-6ES](#) [EPM02FV](#) [701521596](#) [NDS08V](#) [76SB05](#) [79A10](#) [TD06H0SK1](#) [Z7.255.9027.0](#) [1-1825058-3](#) [1825428-4](#) [219-10LPSTF](#) [E3ZG6111D03M](#) [G4D212PUSTV2DC5](#) [195-7MSTN](#) [NDI05H](#) [EPG301BT06](#)