

1

2

3

4

5

## TECHNICAL CHARACTERISTICS

MATERIAL  
 INSULATOR: NYLON 66  
 FLAMABILITY RATING: UL94-V0  
 COLOR: BEIGE  
 PITCH: 2.54 MM

ENVIRONMENTAL  
 OPERATING TEMPERATURE: -40 UP TO 105°C  
 COMPLIANCE: LEAD FREE AND ROHS

ELECTRICAL  
 INSULATOR RESISTANCE: >1000 MOHM  
 DIELECTRIC WITHSTANDING VOLTAGE: 1000 VAC/MN

STANDARD  
 CERTIFIED: E323964

PACKAGING  
 BAG

## DIMENSION

PINS	A
2	5.60
3	8.10
4	10.70
5	13.20
6	15.80
8	20.90
10	25.90
12	31.00
14	36.10

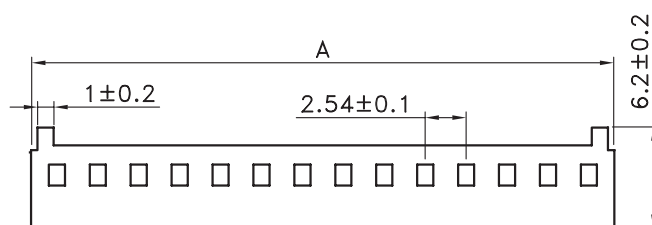
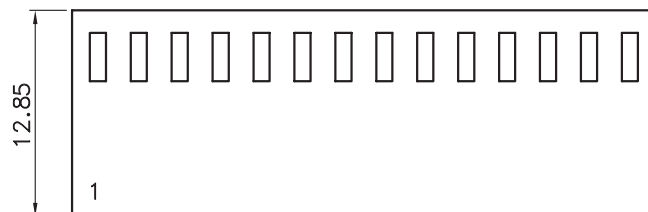
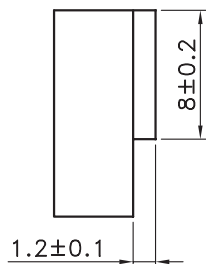
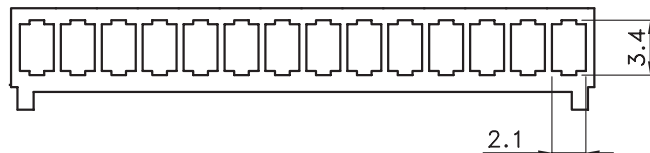

RoHS Compliant

PROJECTION:



GENERAL TOLERANCE

.X =  $\pm 0.2$ .XX =  $\pm 0.15$ 

WÜRTH ELEKTRONIK

APPROVAL: BBu

UNIT: MM

SCALE:

SHEET: 1/3

DRAW: PEARL

DESCRIPTION: 2.54 MM FEMALE TERMINAL HOUSING

WERI PART NO: 619 0xx 116 21

SIZE

A4

REV	DATE	FILE	BY	APPROVAL: BBu	UNIT: MM	DESCRIPTION: 2.54 MM FEMALE TERMINAL HOUSING	SIZE
J	29-SEP-17	TPK	AK				
I	12-SEP-16	DRAWING	AK				
H	19-JAN-16	TPK	AK				
REV	DATE	FILE	BY				

1

2

3

4

5



PE BAG

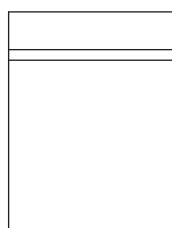

Note:

1.Dimension:

Carton Size:40\*28\*28(cm)

Pin.	Pcs/Bag	Pcs/Carton	Pin.	Pcs/Bag	Pcs/Carton
2	1000	38000	7	1000	12000
3	1000	24000	8	1000	10000
4	1000	20000	9	1000	10000
5	1000	16000	10	1000	7000
6	1000	12000	12	1000	5000

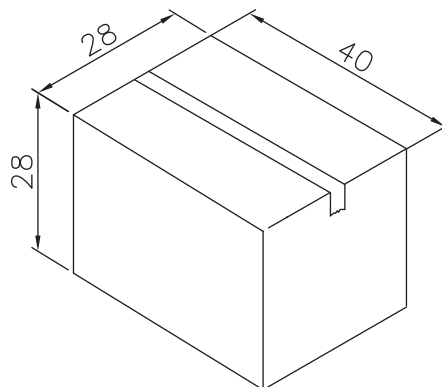
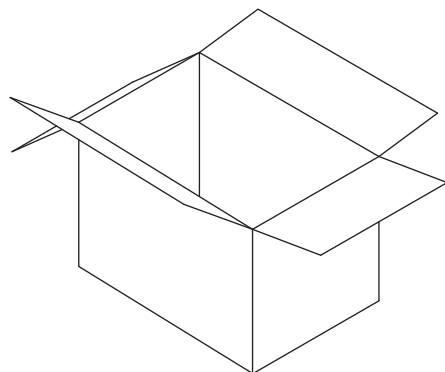

Carton

RoHS Compliant

G			
F			
E			
D			
C			
B			
A			
REV	DATE	FILE	BY

PROJECTION:



GENERAL TOLERANCE

.X = +/- 0.2

.XX = +/- 0.15



WÜRTH ELEKTRONIK

APPROVAL: BBu

UNIT: MM

SCALE:

SHEET: 2/3

DRAW: PEARL

DESCRIPTION: 2.54 MM FEMALE TERMINAL HOUSING

WERI PART NO: 619 0xx 116 21

SIZE

A4

1

2

3

4

5

## Cautions and Warnings:

This electronic component is designed and developed with the intention for use in general electronics equipments.

Before incorporating the components into any equipments in the field such as aerospace, aviation, nuclear control, submarine, transportation, (automotive control, train control, ship control), transportation signal, disaster prevention, medical, public information network etc. where higher safety and reliability are especially required or if there is possibility of direct damage or injury to human body, Würth Elektronik must be asked for a written approval.

In addition, even electronic component in general electronic equipments, when used in electrical circuits that require high safety, reliability functions or performance, the sufficient reliability evaluation-check for the safety must be performed before by the user before usage.

A

B

C

RoHS Compliant

G				PROJECTION: 	GENERAL TOLERANCE .X = +/- 0.2 .XX = +/- 0.15		
F							
E							
D							
C				APPROVAL: JC	UNIT: MM	DESCRIPTION: DISCLAIMER	SIZE <b>A4</b>
B					SCALE:		
A	10-SEP-14	PDF	QL		SHEET: 3/3	WERI PART NO: DISCLAIMER	
REV	DATE	FILE	BY		DRAW: QL		

D

## X-ON Electronics

Largest Supplier of Electrical and Electronic Components

*Click to view similar products for [Headers & Wire Housings](#) category:*

*Click to view products by [Würth](#) manufacturer:*

Other Similar products are found below :

[892-18-020-10-001101](#) [58102-G61-06LF](#) [582553-1](#) [0009485154](#) [009176003701906](#) [0050291907](#) [LY20-4P-DT1-P1E-BR](#) [02.125.8002.8](#)  
[609-3404](#) [61062-3](#) [61082-181009](#) [622-3653LF](#) [63453-116](#) [636-1030](#) [636-1427](#) [636-3427](#) [636-4007](#) [641938-9](#) [641991-4](#) [644827-2](#) [65817-010LF](#) [65817-015LF](#) [65863-015LF](#) [66207-023LF](#) [67095-007LF](#) [67601157](#) [68645-018](#) [68648-049](#) [70.362.1628.0](#) [70-4210](#) [70-4226B](#) [70-4853B](#) [707-5020](#) [707-5028](#) [71.350.2428.0](#) [71918-208LF](#) [71961-016LF](#) [733-134](#) [733-162](#) [754199-000](#) [760-3052](#) [787-8014-00](#) [79531-3000](#)  
[FCN-360C032-B](#) [FCN-367T-T012/H](#) [FCN-723D010/2](#) [80.063.4001.1](#) [800-90-001-10-001000](#) [800-90-010-10-002000](#) [801-43-002-10-013000](#)