

1

2

3

4

5

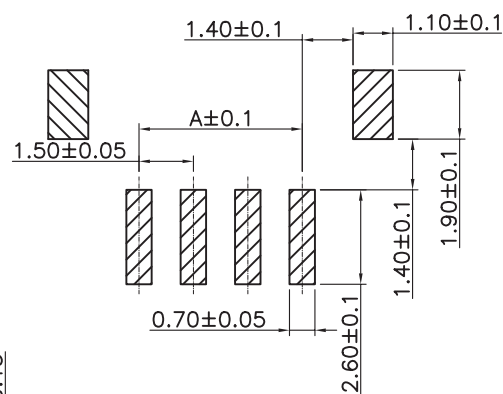
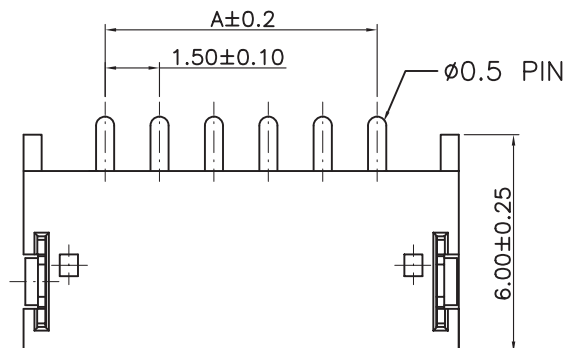
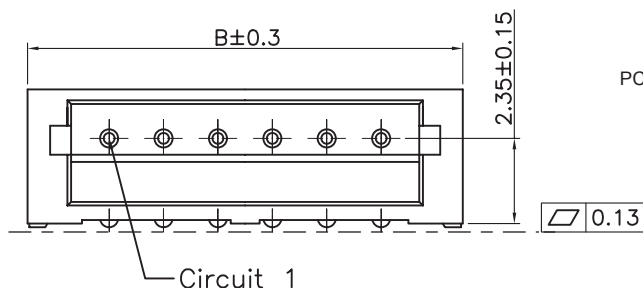
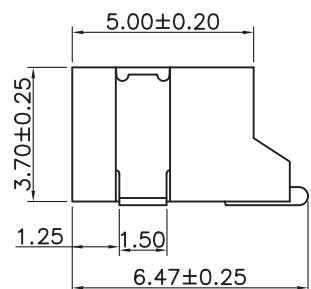

PCB LAYOUT - COMPONENT VIEW

TECHNICAL CHARACTERISTICS

MATERIAL
 INSULATOR: NYLON 6T
 FLAMMABILITY RATING: UL94-V0
 COLOR: IVORY
 CONTACT MATERIAL: COPPER ALLOYS
 CONTACT TYPE: STAMPED
 CONTACT PLATING: TIN
 QUALITY CLASS: 25 MATING CYCLES
 PITCH: 1.50 MM

ENVIRONMENTAL
 OPERATING TEMPERATURE: -25 UP TO 85°C
 COMPLIANCE: LEAD FREE AND ROHS

ELECTRICAL
 CURRENT RATING: 1 A MAX
 WORKING VOLTAGE: 50 VAC
 INSULATOR RESISTANCE: > 500 MOHM
 DIELECTRIC WITHSTANDING VOLTAGE: 500 VAC/MN
 CONTACT RESISTANCE: 20 mOHM MAX

STANDARD
 CERTIFIED: E323964

SOLDERING
 JEDEC LEAD FREE REFLOW SOLDERING PROCESS

PACKAGING
 TAPE & REEL

DIMENSION

NB PIN	A	B	NB PIN	A	B
2	1.50	6.00	8	10.50	15.00
3	3.00	7.50	9	12.00	16.50
4	4.50	9.00	10	13.50	18.00
5	6.00	10.50	11	15.00	19.50
6	7.50	12.00	12	16.50	21.00
7	9.00	13.50	13	18.00	22.50

RoHS Compliant

PROJECTION:

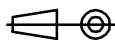

GENERAL TOLERANCE

.X = +/- 0.2

.XX = +/- 0.15



APPROVAL: BBu

UNIT: MM

DESCRIPTION: 1.50 MM SMT MALE HORIZONTAL SHROUDED HEADER

SIZE

28-FEB-17

TPK

AK

SCALE:

WERI PART NO: 648 1xx 131 822

A4

01-SEP-16

CERTIFIED / RESIST

AK

SHEET: 1/3

REV DATE FILE BY

FILE

BY

DRAW: ANDY

1

2

3

4

5

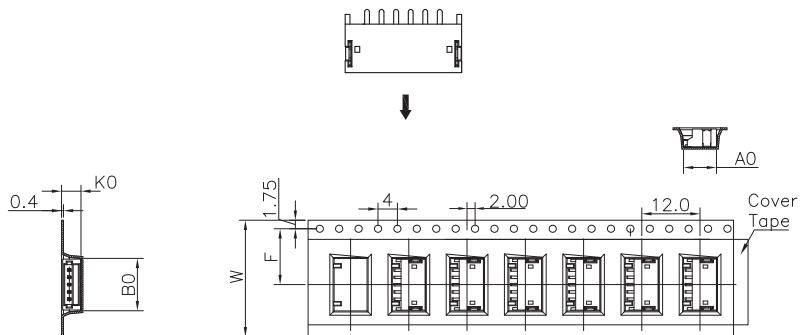

For Reel width (dimension W) 16,24mm
Single row hole

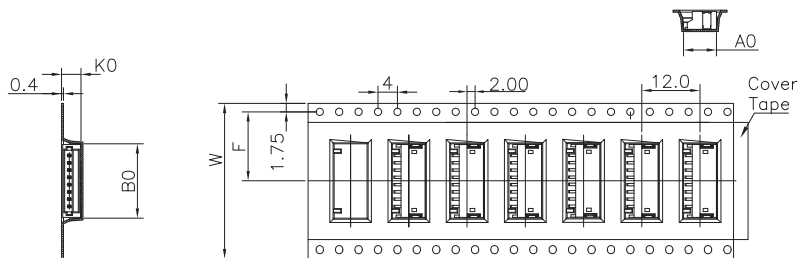

For Reel width (dimension W) 32,44,56,72mm
Double rows hole

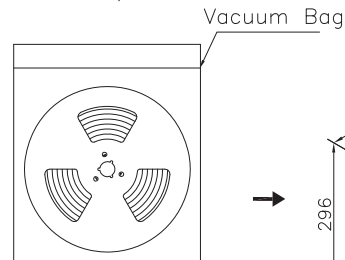
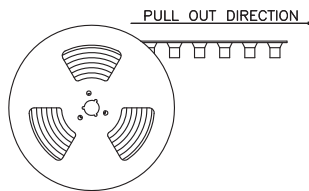
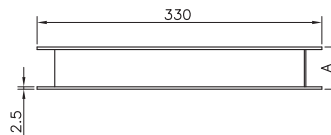

Note:

- 1.All dimensions meet EIA-481-3 requirements.
- 2.Material : White Conductive Polystyrene Alloy
100% recyclable.
- 3.Thickness : 0.4±0.05mm
- 4.Component load per 13" reel :1000 pcs.
- 5.Carton Size:350*350*296(MM)

Pin No	W	F	A0	B0	K0	PCS/R	R/CTN	Q'TY
02	16	7.5	6.8	6.3	4.0	1000	12	12000
03	16	7.5	6.8	7.8	4.0	1000	12	12000
04	24	11.5	6.8	9.3	4.0	1000	9	9000
05	24	11.5	6.8	10.8	4.0	1000	9	9000
06	24	11.5	6.8	12.3	4.0	1000	9	9000
07	24	11.5	6.8	13.8	4.0	1000	9	9000
08	32	14.2	6.8	15.3	4.0	1000	7	7000
09	32	14.2	6.8	16.8	4.0	1000	7	7000
10	32	14.2	6.8	18.3	4.0	1000	7	7000
11	44	20.2	6.8	19.8	4.0	1000	5	5000
12	44	20.2	6.8	21.3	4.0	1000	5	5000
13	44	20.2	6.8	22.8	4.0	1000	5	5000

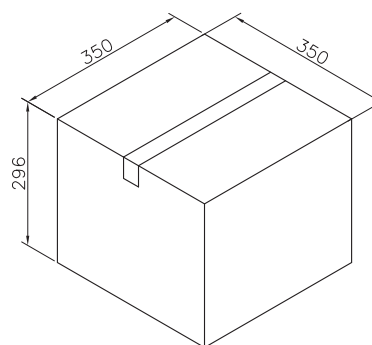

RoHS Compliant

PROJECTION:

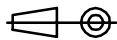

GENERAL TOLERANCE

.X = +/- 0.2
.XX = +/- 0.15



APPROVAL: BBu

UNIT: MM

SCALE:

SHEET: 2/3

DRAW: AK

DESCRIPTION: 1.50 MM SMT MALE HORIZONTAL SHROUDED HEADER

WERI PART NO: 648 1xx 131 822

SIZE

A4

REV	DATE	FILE	BY
-----	------	------	----

1

2

3

4

5

Cautions and Warnings:

This electronic component is designed and developed with the intention for use in general electronics equipments.



Before incorporating the components into any equipments in the field such as aerospace, aviation, nuclear control, submarine, transportation, (automotive control, train control, ship control), transportation signal, disaster prevention, medical, public information network etc. where higher safety and reliability are especially required or if there is possibility of direct damage or injury to human body, Würth Elektronik must be asked for a written approval.

In addition, even electronic component in general electronic equipments, when used in electrical circuits that require high safety, reliability functions or performance, the sufficient reliability evaluation-check for the safety must be performed before by the user before usage.

A

B

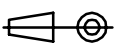
C

RoHS Compliant				PROJECTION: 	GENERAL TOLERANCE .X = +/- 0.2 .XX = +/- 0.15		DESCRIPTION: DISCLAIMER	SIZE A4
G								
F								
E								
D								
C				APPROVAL: JC	UNIT: MM	WERI PART NO: DISCLAIMER	SIZE A4	
B				SCALE:				
A	10-SEP-14	PDF	QL	SHEET: 3/3				
REV	DATE	FILE	BY	DRAW: QL				

D

X-ON Electronics

Largest Supplier of Electrical and Electronic Components

Click to view similar products for [Headers & Wire Housings](#) category:

Click to view products by [Wurth](#) manufacturer:

Other Similar products are found below :

[892-18-020-10-001101](#) [58102-G61-06LF](#) [582553-1](#) [0009485154](#) [009176003701906](#) [0050291907](#) [LY20-4P-DT1-P1E-BR](#) [02.125.8002.8](#)
[609-3404](#) [61062-3](#) [61082-181009](#) [622-3653LF](#) [63453-116](#) [636-1030](#) [636-1427](#) [636-3427](#) [636-4007](#) [641938-9](#) [641991-4](#) [644827-2](#) [65817-](#)
[010LF](#) [65817-015LF](#) [65863-015LF](#) [66207-023LF](#) [67095-007LF](#) [67601157](#) [68645-018](#) [68648-049](#) [70.362.1628.0](#) [70-4210](#) [70-4226B](#) [70-](#)
[4853B](#) [707-5020](#) [707-5028](#) [71.350.2428.0](#) [71918-208LF](#) [71961-016LF](#) [733-134](#) [733-162](#) [754199-000](#) [760-3052](#) [79531-3000](#) [FCN-](#)
[360C032-B](#) [FCN-367T-T012/H](#) [FCN-723D010/2](#) [80.063.4001.1](#) [800-90-010-10-002000](#) [801-43-002-10-013000](#) [801-43-006-10-002000](#)
[801-93-011-10-001000](#)