

PCB LAYOUT - COMPONENT VIEW

TECHNICAL CHARACTERISTICS

MATERIAL
 INSULATOR: LCP
 FLAMABILITY RATING: UL94-V0
 COLOR: BLACK
 CONTACT MATERIAL: COPPER ALLOY
 CONTACT TYPE: STAMPED
 CONTACT PLATING: TIN
 QUALITY CLASS: 25 MATING CYCLES
 PITCH: 3.00MM

ENVIRONMENTAL
 OPERATING TEMPERATURE: -40 UP TO 105°C
 COMPLIANCE: LEAD FREE AND ROHS

ELECTRICAL
 CURRENT RATING: 5A
 WORKING VOLTAGE: 250V AC
 INSULATOR RESISTANCE: >1000 MOHM
 DIELECTRIC WITHSTANDING VOLTAGE: 1500V AC/MN
 CONTACT RESISTANCE: 10 mOHM MAX

STANDARD
 CERTIFIED: E323964

SOLDERING
 JEDEC LEAD FREE REFLOW SOLDERING PROCESS

PACKAGING
 TRAY

DIMENSION
 A = 3.00 x (NB. PIN / 2 - 1)
 B = 3.00 x (NB. PIN / 2 + 1) + 0.70

RoHS Compliant			
N	07-MAR-16	COPLANARITY	AK
M	02-JUL-15	PINNING	AK
L	29-JUL-13	DWG & CARAC	QL
K	21-JAN-13	DIM A & B MOD	QL
J	06-JUL-12	PLASTIC	GG
I	22-FEB-12	DESCRIPTION	GG
H	29-AUG-11	PACKAGING	JP
REV	DATE	FILE	BY

PROJECTION:	
APPROVAL: BBu	

GENERAL TOLERANCE	
.X = +/- 0.2	
.XX = +/- 0.15	
UNIT: MM	
SCALE:	DESCRIPTION: 3.00MM MALE DUAL ROW SMT VERTICAL HEADER WITH SMT SOLDER TAB
SHEET: 1/3	WERI PART NO: 662 0xx 231 822
DRAW: PEARL	

DESCRIPTION: 3.00MM MALE DUAL ROW SMT VERTICAL HEADER WITH SMT SOLDER TAB	SIZE A4
WERI PART NO: 662 0xx 231 822	

A
B
C

D

1

2

3

4

5

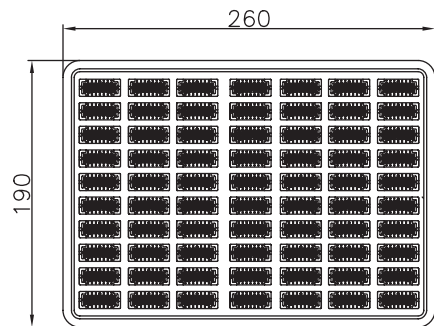
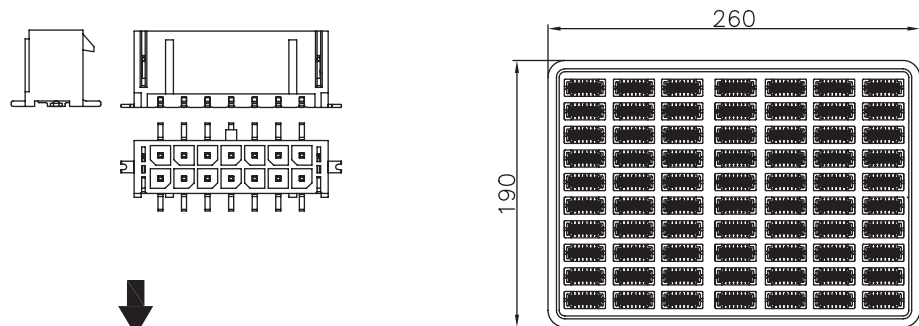

Tray

Note:
 1.Dimension
 Tray Size:260(L)x190(W)x12.0(H) (mm)
 Carton Size:400X280X280(mm)
 2.Quantity:
 XX Pcs/Tray
 48 Trays/Carton

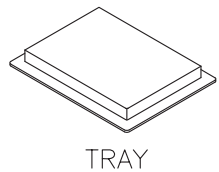

TRAY

Pin.	Pcs/Tray	Tray/Carton	Pcs/Carton
2	140	44	6160
4	120	44	5280
6	100	44	4400
8	90	44	3960
10	80	44	3520
12	70	44	3080
14	70	44	3080
16	60	44	2640
18	60	44	2640
20	50	44	2200
22	50	44	2200
24	40	44	1760

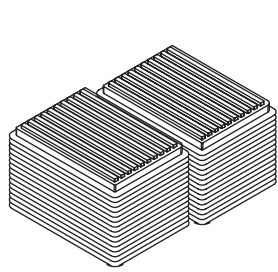

Trays

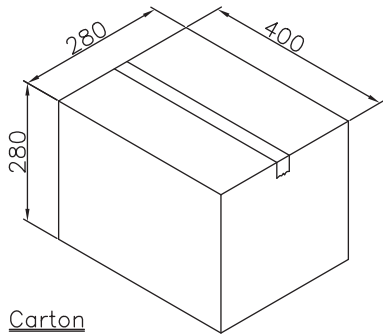

Carton

RoHS Compliant			
G			
F			
E			
D			
C			
B			
A			
REV	DATE	FILE	BY

PROJECTION:
APPROVAL: BBu

GENERAL TOLERANCE
.X = +/- 0.2
.XX = +/- 0.15
UNIT: MM
SCALE:
SHEET: 2/3
DRAW: PEARL



DESCRIPTION: 3.00MM MALE DUAL ROW SMT VERTICAL HEADER WITH SMT SOLDER TAB
WERI PART NO 662 0xx 231 22_TPK

SIZE
A4

A

B

C

D

1

2

3

4

5

Cautions and Warnings:

This electronic component is designed and developed with the intention for use in general electronics equipments.



Before incorporating the components into any equipments in the field such as aerospace, aviation, nuclear control, submarine, transportation, (automotive control, train control, ship control), transportation signal, disaster prevention, medical, public information network etc. where higher safety and reliability are especially required or if there is possibility of direct damage or injury to human body, Würth Elektronik must be asked for a written approval.

In addition, even electronic component in general electronic equipments, when used in electrical circuits that require high safety, reliability functions or performance, the sufficient reliability evaluation-check for the safety must be performed before by the user before usage.

A

B

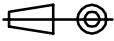
C

RoHS Compliant				PROJECTION: 	GENERAL TOLERANCE .X = +/- 0.2 .XX = +/- 0.15		DESCRIPTION: DISCLAIMER	SIZE A4
G								
F								
E								
D								
C				APPROVAL: JC	UNIT: MM	WERI PART NO: DISCLAIMER	SIZE A4	
B				SCALE:				
A	10-SEP-14	PDF	QL	SHEET: 3/3				
REV	DATE	FILE	BY	DRAW: QL				

D

X-ON Electronics

Largest Supplier of Electrical and Electronic Components

Click to view similar products for [Headers & Wire Housings](#) category:

Click to view products by [Würth](#) manufacturer:

Other Similar products are found below :

[892-18-020-10-001101](#) [58102-G61-06LF](#) [582553-1](#) [0009485154](#) [009176003701906](#) [0050291907](#) [LY20-4P-DT1-P1E-BR](#) [02.125.8002.8](#)
[609-3404](#) [61062-3](#) [61082-181009](#) [622-3653LF](#) [63453-116](#) [636-1030](#) [636-1427](#) [636-3427](#) [636-4007](#) [641938-9](#) [641991-4](#) [644827-2](#) [65817-010LF](#) [65817-015LF](#) [65863-015LF](#) [66207-023LF](#) [67095-007LF](#) [67601157](#) [68645-018](#) [68648-049](#) [70.362.1628.0](#) [70-4210](#) [70-4226B](#) [70-4853B](#) [707-5020](#) [707-5028](#) [71.350.2428.0](#) [71918-208LF](#) [71961-016LF](#) [733-134](#) [733-162](#) [754199-000](#) [760-3052](#) [787-8014-00](#) [79531-3000](#)
[FCN-360C032-B](#) [FCN-367T-T012/H](#) [FCN-723D010/2](#) [80.063.4001.1](#) [800-90-001-10-001000](#) [800-90-010-10-002000](#) [801-43-002-10-013000](#)