

10P~24P: The first 4pin kink and last 4pin Kink

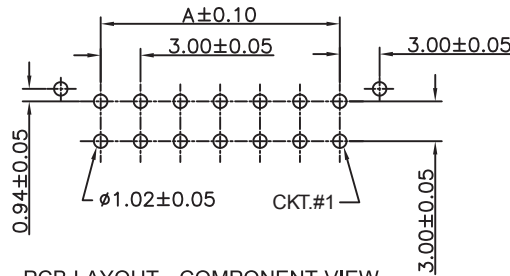

PCB LAYOUT - COMPONENT VIEW

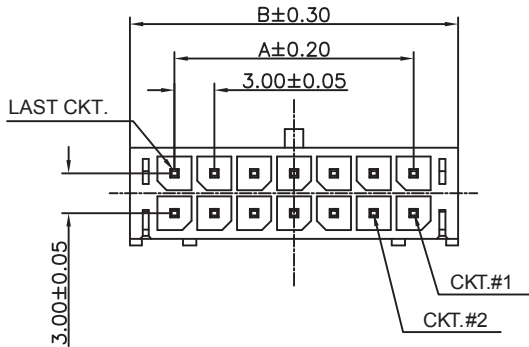
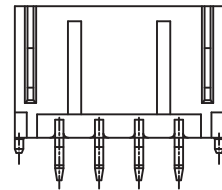

2P~8P: All Kink

TECHNICAL CHARACTERISTICS

MATERIAL  
 INSULATOR: LCP  
 FLAMMABILITY RATING: UL94-V0  
 COLOR: BLACK  
 CONTACT MATERIAL: COPPER ALLOY  
 CONTACT TYPE: STAMPED  
 CONTACT PLATING: TIN  
 QUALITY CLASS: 25 MATING CYCLES  
 PITCH: 3.00MM

ENVIRONMENTAL  
 OPERATING TEMPERATURE: -40 UP TO 105°C  
 COMPLIANCE: LEAD FREE AND ROHS

ELECTRICAL  
 CURRENT RATING: 5 A  
 WORKING VOLTAGE: 250 VAC  
 INSULATOR RESISTANCE: >1000 MΩ  
 DIELECTRIC WITHSTANDING VOLTAGE: 1500 VAC/MIN  
 CONTACT RESISTANCE: 10 mΩ MAX

STANDARD  
 CERTIFIED: E323964

SOLDERING  
 JEDEC LEAD FREE WAVE SOLDERING PROCESS

PACKAGING  
 TUBE

DIMENSION  
 A = 3.00 x (NB. PIN / 2 - 1)  
 B = 3.00 x (NB PIN / 2 + 1) + 0.70

RoHS Compliant			
O	15-MAR-17	KINK	AK
REV	DATE	FILE	BY

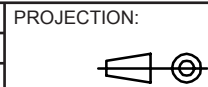

APPROVAL: BBu

GENERAL TOLERANCE

.X = +/- 0.2  
 .XX = +/- 0.15

UNIT: MM

SCALE:

SHEET: 1/3

DRAW: AS



DESCRIPTION: WR-MPC3 - 3.00MM MALE DUAL ROW VERTICAL HEADER

WERI PART NO: 662 0xx 211 22

SIZE

**A4**

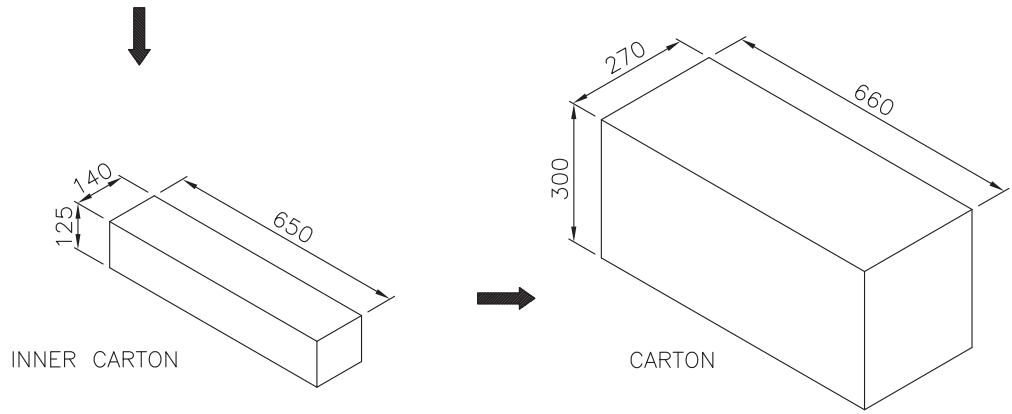
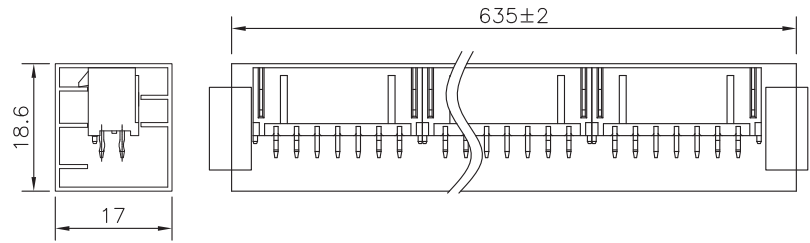

CIRCUITS	PCS/Tube	Tube/Carton	PCS/Carton	PCS/Carton2
02	91	42	3822	15288
04	63	42	2646	10584
06	48	42	2016	8064
08	38	42	1596	6384
10	32	42	1344	5376
12	28	42	1176	4704
14	24	42	1008	4032
16	22	42	924	3696
18	20	42	840	3360
20	18	42	756	3024
22	16	42	672	2688
24	15	42	630	2520

RoHS Compliant			
G			
F			
E			
D			
C			
B			
A			
REV	DATE	FILE	BY

PROJECTION:  
  
 APPROVAL: BBu

GENERAL TOLERANCE  
 .X = +/- 0.2  
 .XX = +/- 0.15  
 UNIT: MM  
 SCALE:  
 SHEET: 2/3  
 DRAW: AK



DESCRIPTION: WR-MPC 3 - 3.00MM MALE DUAL ROW VERTICAL HEADER  
 WERI PART NO: 662 0xx 211 22

SIZE  
**A4**

A  
 B  
 C  
 D

1

2

3

4

5

## Cautions and Warnings:

This electronic component is designed and developed with the intention for use in general electronics equipments.

Before incorporating the components into any equipments in the field such as aerospace, aviation, nuclear control, submarine, transportation, (automotive control, train control, ship control), transportation signal, disaster prevention, medical, public information network etc. where higher safety and reliability are especially required or if there is possibility of direct damage or injury to human body, Würth Elektronik must be asked for a written approval.

In addition, even electronic component in general electronic equipments, when used in electrical circuits that require high safety, reliability functions or performance, the sufficient reliability evaluation-check for the safety must be performed before by the user before usage.

A

B

C

RoHS Compliant				PROJECTION: 	GENERAL TOLERANCE .X = +/- 0.2 .XX = +/- 0.15	 <b>WÜRTH ELEKTRONIK</b>	DESCRIPTION: DISCLAIMER	SIZE <b>A4</b>
G								
F								
E								
D								
C				APPROVAL: JC	UNIT: MM	WERI PART NO: DISCLAIMER	SIZE <b>A4</b>	
B				SCALE:				
A	10-SEP-14	PDF	QL	SHEET: 3/3				
REV	DATE	FILE	BY	DRAW: QL				

D

## X-ON Electronics

Largest Supplier of Electrical and Electronic Components

*Click to view similar products for [Headers & Wire Housings](#) category:*

*Click to view products by [Würth](#) manufacturer:*

Other Similar products are found below :

[892-18-020-10-001101](#) [58102-G61-06LF](#) [582553-1](#) [0009485154](#) [009176003701906](#) [0050291907](#) [LY20-4P-DT1-P1E-BR](#) [02.125.8002.8](#)  
[609-3404](#) [61062-3](#) [61082-181009](#) [622-3653LF](#) [63453-116](#) [636-1030](#) [636-1427](#) [636-3427](#) [636-4007](#) [641938-9](#) [641991-4](#) [644827-2](#) [65817-](#)  
[010LF](#) [65817-015LF](#) [65863-015LF](#) [66207-023LF](#) [67095-007LF](#) [67601157](#) [68645-018](#) [68648-049](#) [70.362.1628.0](#) [70-4210](#) [70-4226B](#) [70-](#)  
[4853B](#) [707-5020](#) [707-5028](#) [71.350.2428.0](#) [71918-208LF](#) [71961-016LF](#) [733-134](#) [733-162](#) [754199-000](#) [760-3052](#) [787-8014-00](#) [79531-3000](#)  
[FCN-360C032-B](#) [FCN-367T-T012/H](#) [FCN-723D010/2](#) [80.063.4001.1](#) [800-90-001-10-001000](#) [800-90-010-10-002000](#) [801-43-002-10-013000](#)