

PCB LAYOUT - COMPONENT VIEW

TECHNICAL CHARACTERISTICS

MATERIAL
 INSULATOR: LCP
 FLAMMABILITY RATING: UL94-V0
 COLOR: BLACK
 CONTACT MATERIAL: COPPER ALLOY
 CONTACT TYPE: STAMPED
 CONTACT PLATING: TIN
 QUALITY CLASS: 25 MATING CYCLES
 PITCH: 3.00MM

ENVIRONMENTAL
 OPERATING TEMPERATURE: -40 UP TO 105°C
 COMPLIANCE: LEAD FREE AND ROHS

ELECTRICAL
 CURRENT RATING: 5A
 WORKING VOLTAGE: 250V AC
 INSULATOR RESISTANCE: >1000 MOHM
 DIELECTRIC WITHSTANDING VOLTAGE: 1500V AC/MN
 CONTACT RESISTANCE: 10 mOHM MAX

STANDARD
 CERTIFIED: E323964

SOLDERING
 JEDEC LEAD FREE REFLOW SOLDERING PROCESS

PACKAGING
 TUBE

DIMENSION
 A = 3.00 x (NB. PIN / 2 - 1)
 B = 3.00 x (NB. PIN / 2 + 1) + 0.70

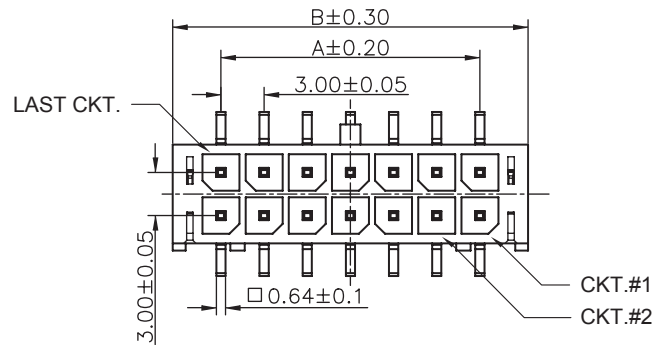
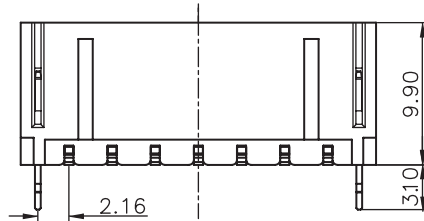
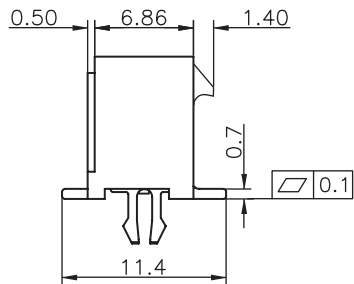

RoHS Compliant

M	05-JUL-17	CORRECTION	AK
L	22-MAR-16	TPK	AK
K	07-MAR-16	COPLANARITY	AK
J	02-JUL-15	PINNING	AK
I	08-AUG-14	DIM.+VIEWS	AS
H	30-JUL-13	PACKAGING	QL
REV	DATE	FILE	BY

PROJECTION:

APPROVAL: BBu

GENERAL TOLERANCE
 .X = +/- 0.2
 .XX = +/- 0.15

UNIT: MM
 SCALE:
 SHEET: 1/3
 DRAW: JACK

DESCRIPTION: 3.00MM MALE DUAL ROW SMT VERTICAL HEADER WITH THT METAL CLIP

WERI PART NO: 662 0xx 235 922

SIZE
A4

A

B

C

D

1

2

3

4

5

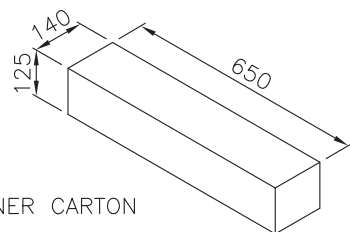
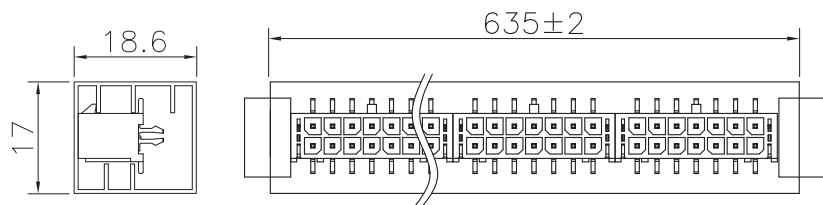

INNER CARTON

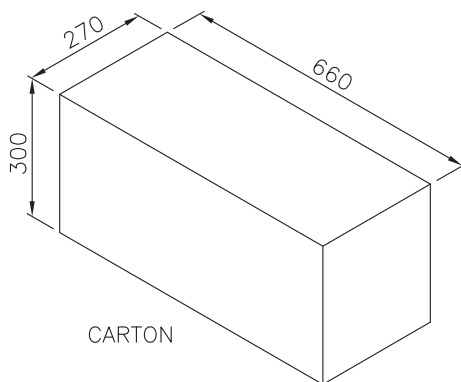

CARTON

CIRCUITS	PCS/Tube	Tube/Carton	PCS/Carton	PCS/Carton2
02	91	42	3822	15288
04	63	42	2646	10584
06	48	42	2016	8064
08	38	42	1596	6384
10	32	42	1344	5376
12	28	42	1176	4704
14	24	42	1008	4032
16	22	42	924	3696
18	20	42	840	3360
20	18	42	756	3024
22	16	42	672	2688
24	15	42	630	2520

RoHS Compliant

PROJECTION:



GENERAL TOLERANCE

.X = ± 0.2 .XX = ± 0.15 

WÜRTH ELEKTRONIK

APPROVAL: BBu

UNIT: MM

SCALE:

SHEET: 2/3

DRAW: QP

DESCRIPTION: 3.00MM MALE DUAL ROW SMT VERTICAL HEADER WITH THT METAL CLIP

WERI PART NO: 662 0xx 235 922

SIZE

A4

G			
F			
E			
D			
C			
B			
A			
REV	DATE	FILE	BY

1

2

3

4

5

Cautions and Warnings:

This electronic component is designed and developed with the intention for use in general electronics equipments.

Before incorporating the components into any equipments in the field such as aerospace, aviation, nuclear control, submarine, transportation, (automotive control, train control, ship control), transportation signal, disaster prevention, medical, public information network etc. where higher safety and reliability are especially required or if there is possibility of direct damage or injury to human body, Würth Elektronik must be asked for a written approval.



In addition, even electronic component in general electronic equipments, when used in electrical circuits that require high safety, reliability functions or performance, the sufficient reliability evaluation-check for the safety must be performed before by the user before usage.

A

B

C

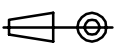
RoHS Compliant

G				PROJECTION: 	GENERAL TOLERANCE .X = +/- 0.2 .XX = +/- 0.15		
F							
E							
D							
C				APPROVAL: JC	UNIT: MM	DESCRIPTION: DISCLAIMER	SIZE A4
B					SCALE:		
A	10-SEP-14	PDF	QL		SHEET: 3/3	WERI PART NO: DISCLAIMER	
REV	DATE	FILE	BY		DRAW: QL		

D

X-ON Electronics

Largest Supplier of Electrical and Electronic Components

Click to view similar products for [Headers & Wire Housings](#) category:

Click to view products by [Würth](#) manufacturer:

Other Similar products are found below :

[892-18-020-10-001101](#) [58102-G61-06LF](#) [582553-1](#) [0009485154](#) [009176003701906](#) [0050291907](#) [LY20-4P-DT1-P1E-BR](#) [02.125.8002.8](#)
[609-3404](#) [61062-3](#) [61082-181009](#) [622-3653LF](#) [63453-116](#) [636-1030](#) [636-1427](#) [636-3427](#) [636-4007](#) [641938-9](#) [641991-4](#) [644827-2](#) [65817-010LF](#) [65817-015LF](#) [65863-015LF](#) [66207-023LF](#) [67095-007LF](#) [67601157](#) [68645-018](#) [68648-049](#) [70.362.1628.0](#) [70-4210](#) [70-4226B](#) [70-4853B](#) [707-5020](#) [707-5028](#) [71.350.2428.0](#) [71918-208LF](#) [71961-016LF](#) [733-134](#) [733-162](#) [754199-000](#) [760-3052](#) [787-8014-00](#) [79531-3000](#)
[FCN-360C032-B](#) [FCN-367T-T012/H](#) [FCN-723D010/2](#) [80.063.4001.1](#) [800-90-001-10-001000](#) [800-90-010-10-002000](#) [801-43-002-10-013000](#)