

PCB LAYOUT - COMPONENT VIEW

TECHNICAL CHARACTERISTICS

MATERIAL
 INSULATOR: LCP
 FLAMABILITY RATING: UL94-V0
 COLOR: BLACK
 CONTACT MATERIAL: COPPER ALLOY
 CONTACT TYPE: STAMPED
 CONTACT PLATING: TIN
 QUALITY CLASS: 25 MATING CYCLES
 PITCH: 3.00MM

ENVIRONMENTAL

OPERATING TEMPERATURE: -40 UP TO 105°C
 COMPLIANCE: LEAD FREE AND ROHS

ELECTRICAL

CURRENT RATING: 5 A
 WORKING VOLTAGE: 250 VAC
 INSULATOR RESISTANCE: >1000 MOHM
 DIELECTRIC WITHSTANDING VOLTAGE: 1500 VAC/MN
 CONTACT RESISTANCE: 10 mOHM MAX

STANDARD

CERTIFIED: E323964

SOLDERING

JEDEC LEAD FREE REFLOW PROCESS

PACKAGING

TAPE & REEL

DIMENSION

A = 3.00 x (NB. PIN - 1)
 B = 3.00 x (NB. PIN) + 3.65
 C = 3.00 x (NB. PIN) + 8.20

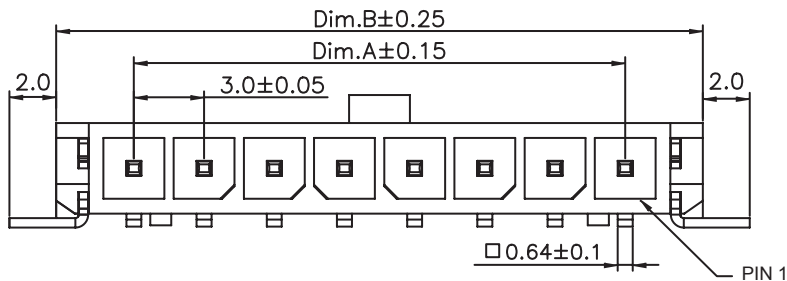
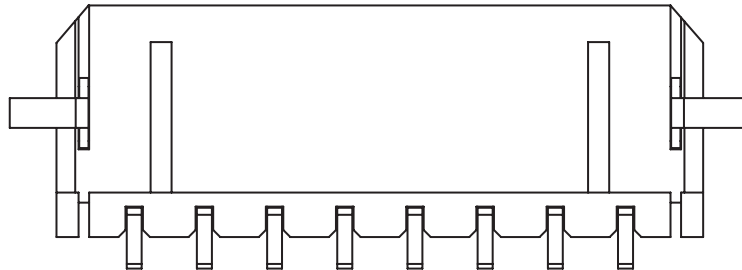
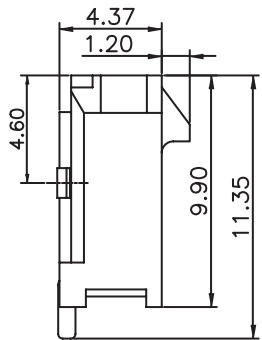

RoHS Compliant			
H	02-JUN-16	TPK	AK
REV	DATE	FILE	BY

PROJECTION:	
APPROVAL: BBu	

GENERAL TOLERANCE
.X = +/- 0.2
.XX = +/- 0.15
UNIT: MM
SCALE:
SHEET: 1/3
DRAW: MIKE



DESCRIPTION: 3.00MM SMT SINGLE ROW MALE RIGHT ANGLED HEADER WITH SMT SOLDER TABS
WERI PART NO: 662 1xx 145 021

SIZE
A4

A
 B
 C

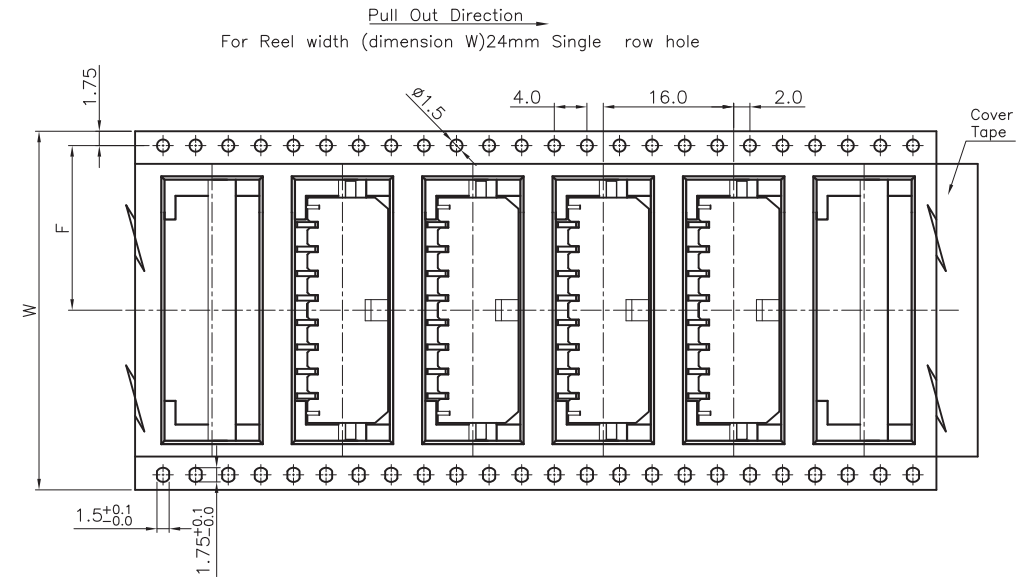
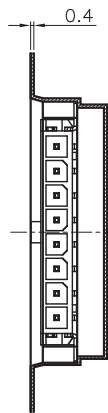
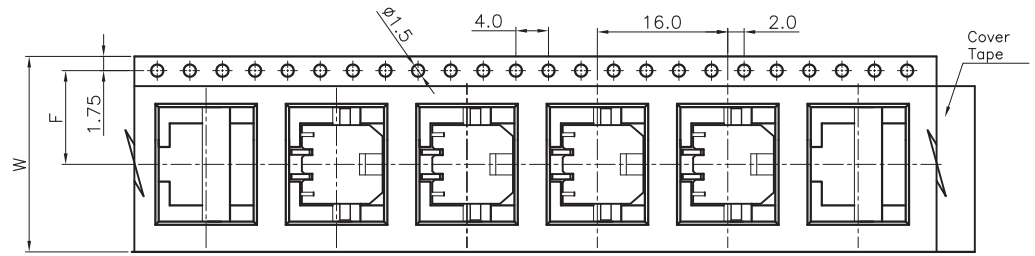
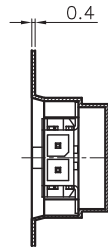
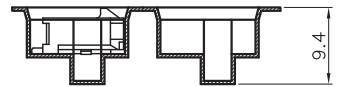
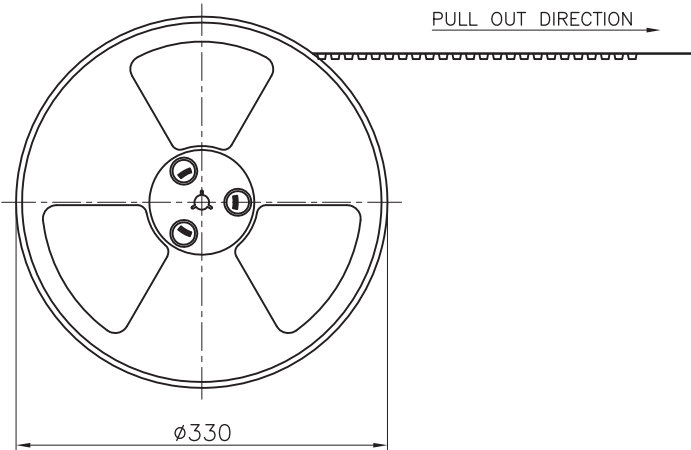

TAPE PACKING

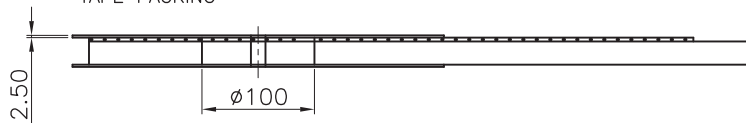

Pin No	W	F	PCS/R	R/CTN	Q'TY
02	24	11.5	400	9	3600
03-04	32	14.2	400	7	2800
05-08	44	20.2	400	5	2000
09-12	56	26.2	400	4	1600

- Note:
- All dimensions meet EIA-481-3 requirements.
 - Material: BK Conductive Polystyrene Alloy
100% recyclable.
 - Thickness : 0.40±0.05mm
 - Carton Size:350*350*296(mm)

RoHS Compliant	
F	
E	
D	
C	
B	
A	
REV	DATE
	FILE
	BY

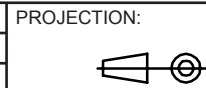

APPROVAL: BBu

GENERAL TOLERANCE
 .X = ± 0.2
 .XX = ± 0.15



DESCRIPTION: 3.00MM SMT SINGLE ROW MALE RIGHT ANGLED HEADER WITH SMT SOLDER TABS

WERI PART NO: 662 1xx 145 021

SIZE
A4

1

2

3

4

5

Cautions and Warnings:

This electronic component is designed and developed with the intention for use in general electronics equipments.

Before incorporating the components into any equipments in the field such as aerospace, aviation, nuclear control, submarine, transportation, (automotive control, train control, ship control), transportation signal, disaster prevention, medical, public information network etc. where higher safety and reliability are especially required or if there is possibility of direct damage or injury to human body, Würth Elektronik must be asked for a written approval.

In addition, even electronic component in general electronic equipments, when used in electrical circuits that require high safety, reliability functions or performance, the sufficient reliability evaluation-check for the safety must be performed before by the user before usage.

A

B

C

RoHS Compliant				PROJECTION: 	GENERAL TOLERANCE .X = +/- 0.2 .XX = +/- 0.15		DESCRIPTION: DISCLAIMER	SIZE A4
G								
F								
E								
D								
C				APPROVAL: JC	UNIT: MM	WERI PART NO: DISCLAIMER	SIZE A4	
B					SCALE:			
A	10-SEP-14	PDF	QL		SHEET: 3/3			
REV	DATE	FILE	BY		DRAW: QL			

D

X-ON Electronics

Largest Supplier of Electrical and Electronic Components

Click to view similar products for [Headers & Wire Housings](#) category:

Click to view products by [Wurth](#) manufacturer:

Other Similar products are found below :

[892-18-020-10-001101](#) [58102-G61-06LF](#) [582553-1](#) [0009485154](#) [009176003701906](#) [0050291907](#) [LY20-4P-DT1-P1E-BR](#) [02.125.8002.8](#)
[609-3404](#) [61062-3](#) [61082-181009](#) [622-3653LF](#) [63453-116](#) [636-1030](#) [636-1427](#) [636-3427](#) [636-4007](#) [641938-9](#) [641991-4](#) [644827-2](#) [65817-](#)
[010LF](#) [65817-015LF](#) [65863-015LF](#) [66207-023LF](#) [67095-007LF](#) [67601157](#) [68645-018](#) [68648-049](#) [70.362.1628.0](#) [70-4210](#) [70-4226B](#) [70-](#)
[4853B](#) [707-5020](#) [707-5028](#) [71.350.2428.0](#) [71918-208LF](#) [71961-016LF](#) [733-134](#) [733-162](#) [754199-000](#) [760-3052](#) [79531-3000](#) [FCN-](#)
[360C032-B](#) [FCN-367T-T012/H](#) [FCN-723D010/2](#) [80.063.4001.1](#) [800-90-010-10-002000](#) [801-43-002-10-013000](#) [801-43-006-10-002000](#)
[801-93-011-10-001000](#)