

PCB LAYOUT - COMPONENT VIEW

TECHNICAL CHARACTERISTICS

MATERIAL  
 INSULATOR: LCP  
 FLAMABILITY RATING: UL94-V0  
 COLOR: BLACK  
 CONTACT MATERIAL: COPPER ALLOY  
 CONTACT TYPE: STAMPED  
 CONTACT PLATING: TIN  
 QUALITY CLASS: 25 MATING CYCLES  
 PITCH: 3.00MM

ENVIRONMENTAL

OPERATING TEMPERATURE: -40 UP TO 105°C  
 COMPLIANCE: LEAD FREE AND ROHS

ELECTRICAL

CURRENT RATING: 5 A  
 WORKING VOLTAGE: 250 VAC  
 INSULATOR RESISTANCE: >1000 MOHM  
 DIELECTRIC WITHSTANDING VOLTAGE: 1500 VAC/MN  
 CONTACT RESISTANCE: 10 mOHM MAX

STANDARD

CERTIFIED: E323964

SOLDERING

JEDEC LEAD FREE REFLOW PROCESS

PACKAGING

TAPE & REEL

DIMENSION

A = 3.00 x (NB. PIN - 1)  
 B = 3.00 x (NB. PIN) + 3.65  
 C = 3.00 x (NB. PIN) + 8.20

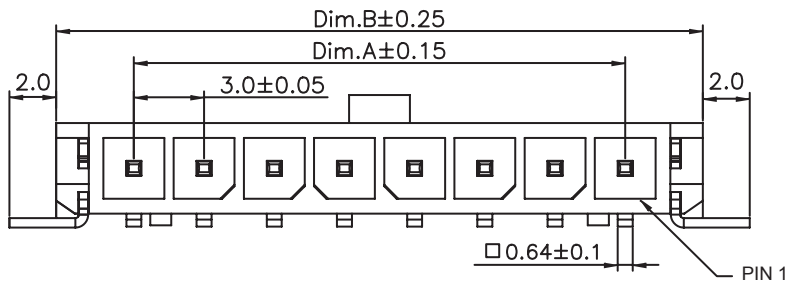
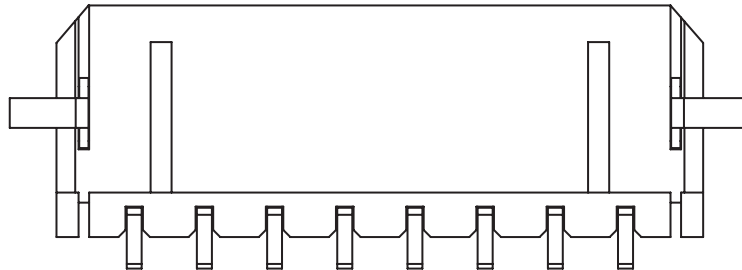
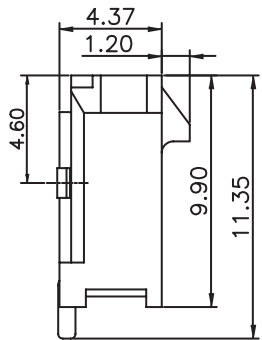

|                |           |      |    |
|----------------|-----------|------|----|
| RoHS Compliant |           |      |    |
|                |           |      |    |
|                |           |      |    |
|                |           |      |    |
|                |           |      |    |
| H              | 02-JUN-16 | TPK  | AK |
| REV            | DATE      | FILE | BY |

|               |  |
|---------------|--|
| PROJECTION:   |  |
| APPROVAL: BBu |  |

|                   |
|-------------------|
| GENERAL TOLERANCE |
| .X = +/- 0.2      |
| .XX = +/- 0.15    |
| UNIT: MM          |
| SCALE:            |
| SHEET: 1/3        |
| DRAW: MIKE        |



|  |
|--|
| DESCRIPTION: 3.00MM SMT SINGLE ROW MALE RIGHT ANGLED HEADER WITH SMT SOLDER TABS |
| WERI PART NO: 662 1xx 145 021  |

SIZE  
**A4**

A  
 B  
 C

D

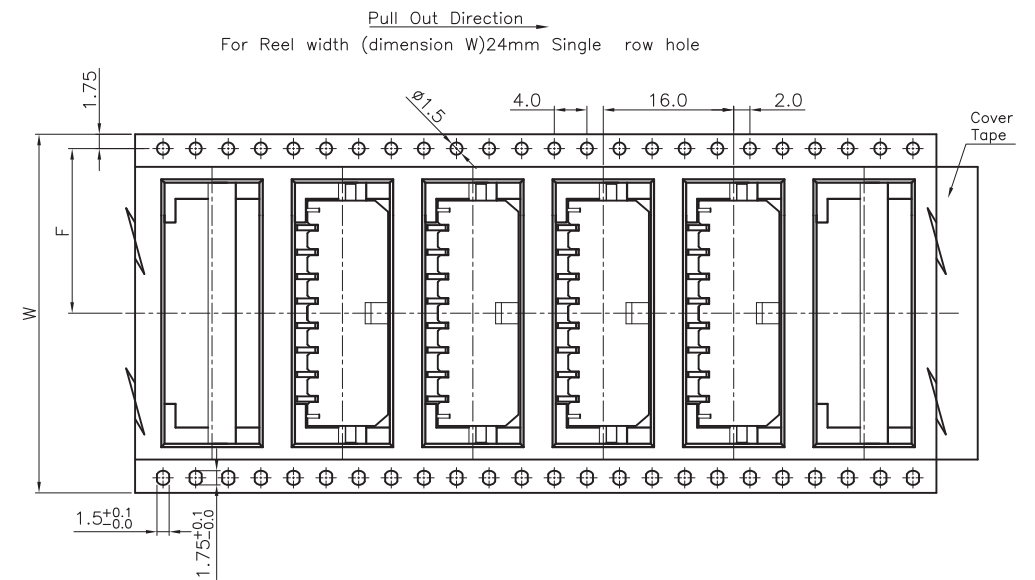
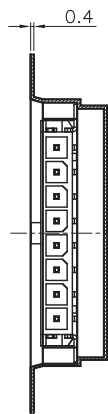
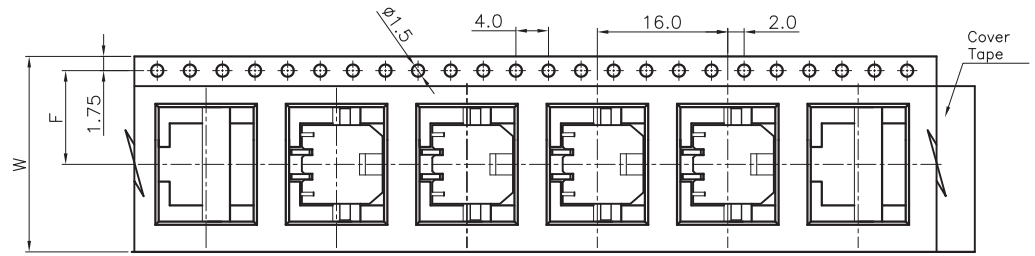
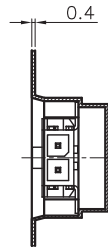
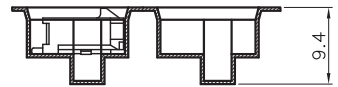
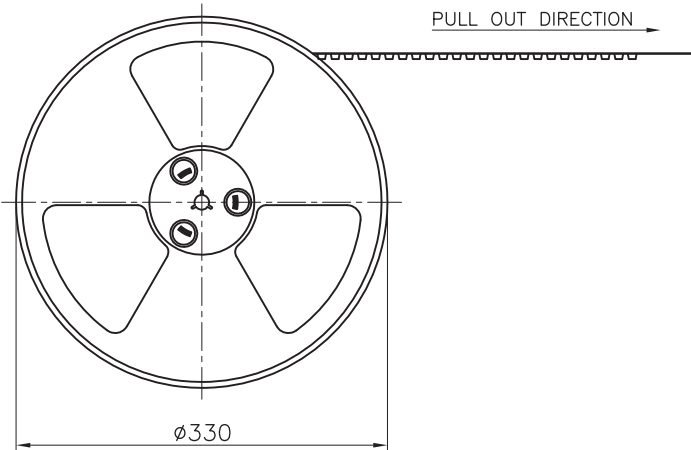

TAPE PACKING

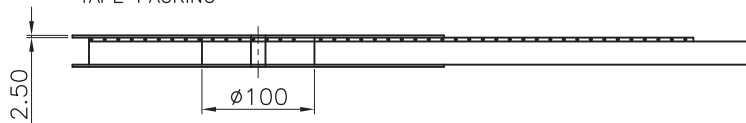

| Pin No | W  | F    | PCS/R | R/CTN | Q'TY |
|--------|----|------|-------|-------|------|
| 02     | 24 | 11.5 | 400   | 9     | 3600 |
| 03-04  | 32 | 14.2 | 400   | 7     | 2800 |
| 05-08  | 44 | 20.2 | 400   | 5     | 2000 |
| 09-12  | 56 | 26.2 | 400   | 4     | 1600 |

Note:

- All dimensions meet EIA-481-3 requirements.
- Material: BK Conductive Polystyrene Alloy  
100% recyclable.
- Thickness : 0.40±0.05mm
- Carton Size:350\*350\*296(mm)

| RoHS Compliant |      |
|----------------|------|
| F              |      |
| E              |      |
| D              |      |
| C              |      |
| B              |      |
| A              |      |
| REV            | DATE |

| FILE | BY |
|------|----|
|      |    |

|               |  |
|---------------|--|
| PROJECTION:   |  |
| APPROVAL: BBu |  |

|                   |
|-------------------|
| GENERAL TOLERANCE |
| .X = +/- 0.2      |
| .XX = +/- 0.15    |
| UNIT: MM          |
| SCALE:            |
| SHEET: 2/3        |
| DRAW: AK          |

|  |  |
|--|--|
|  | DESCRIPTION: 3.00MM SMT SINGLE ROW MALE RIGHT ANGLED HEADER WITH SMT SOLDER TABS |
|  | WERI PART NO: 662 1xx 145 021  |

|           |
|-----------|
| SIZE      |
| <b>A4</b> |

1

2

3

4

5

## Cautions and Warnings:

This electronic component is designed and developed with the intention for use in general electronics equipments.



Before incorporating the components into any equipments in the field such as aerospace, aviation, nuclear control, submarine, transportation, (automotive control, train control, ship control), transportation signal, disaster prevention, medical, public information network etc. where higher safety and reliability are especially required or if there is possibility of direct damage or injury to human body, Würth Elektronik must be asked for a written approval.

In addition, even electronic component in general electronic equipments, when used in electrical circuits that require high safety, reliability functions or performance, the sufficient reliability evaluation-check for the safety must be performed before by the user before usage.

A

B

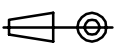
C

|                |           |      |    |  |   |   |                         |                   |
|----------------|-----------|------|----|--|---|---|-------------------------|-------------------|
| RoHS Compliant |           |      |    | PROJECTION:<br> | GENERAL TOLERANCE<br>.X = +/- 0.2<br>.XX = +/- 0.15 |  | DESCRIPTION: DISCLAIMER | SIZE<br><b>A4</b> |
| G              |           |      |    |  |   |   |                         |                   |
| F              |           |      |    |  |   |   |                         |                   |
| E              |           |      |    |  |   |   |                         |                   |
| D              |           |      |    |  |   |   |                         |                   |
| C              |           |      |    | APPROVAL: JC   | UNIT: MM  | WERI PART NO: DISCLAIMER  | SIZE<br><b>A4</b>       |                   |
| B              |           |      |    |  | SCALE:  |   |                         |                   |
| A              | 10-SEP-14 | PDF  | QL |  | SHEET: 3/3  |   |                         |                   |
| REV            | DATE      | FILE | BY |  | DRAW: QL  |   |                         |                   |

D

## X-ON Electronics

Largest Supplier of Electrical and Electronic Components

*Click to view similar products for [Headers & Wire Housings](#) category:*

*Click to view products by [Würth](#) manufacturer:*

Other Similar products are found below :

[892-18-020-10-001101](#) [58102-G61-06LF](#) [582553-1](#) [0009485154](#) [009176003701906](#) [0050291907](#) [LY20-4P-DT1-P1E-BR](#) [02.125.8002.8](#)  
[609-3404](#) [61062-3](#) [61082-181009](#) [622-3653LF](#) [63453-116](#) [636-1030](#) [636-1427](#) [636-3427](#) [636-4007](#) [641938-9](#) [641991-4](#) [644827-2](#) [65817-010LF](#) [65817-015LF](#) [65863-015LF](#) [66207-023LF](#) [67095-007LF](#) [67601157](#) [68645-018](#) [68648-049](#) [70.362.1628.0](#) [70-4210](#) [70-4226B](#) [70-4853B](#) [707-5020](#) [707-5028](#) [71.350.2428.0](#) [71918-208LF](#) [71961-016LF](#) [733-134](#) [733-162](#) [754199-000](#) [760-3052](#) [787-8014-00](#) [79531-3000](#)  
[FCN-360C032-B](#) [FCN-367T-T012/H](#) [FCN-723D010/2](#) [80.063.4001.1](#) [800-90-001-10-001000](#) [800-90-010-10-002000](#) [801-43-002-10-013000](#)