

1

2

3

4

5

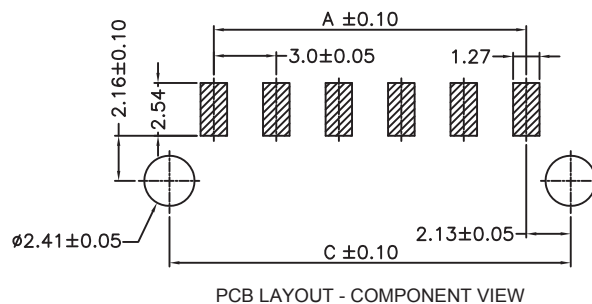

TECHNICAL CHARACTERISTICS

MATERIAL
 INSULATOR: LCP
 FLAMABILITY RATING: UL94-V0
 COLOR: BLACK
 CONTACT MATERIAL: COPPER ALLOY
 CONTACT TYPE: STAMPED
 CONTACT PLATING: TIN
 QUALITY CLASS: 25 MATING CYCLES
 PITCH: 3.00MM

ENVIRONMENTAL
 OPERATING TEMPERATURE: -40 UP TO 105 °C
 COMPLIANCE: LEAD FREE AND ROHS

ELECTRICAL
 CURRENT RATING: 5A
 WORKING VOLTAGE: 250 VAC
 INSULATOR RESISTANCE: >1000 MOHM
 DIELECTRIC WITHSTANDING VOLTAGE: 1500 VAC/MN
 CONTACT RESISTANCE: 10 mOHM MAX

STANDARD
 CERTIFIED: E323964

SOLDERING
 JEDEC LEAD FREE REFLOW SOLDERING PROCESS

PACKAGING
 TAPE AND REEL WITH CAP

DIMENSION
 A = 3.00 x (NB. PIN -1)
 B = 3.00 x (NB. PIN +1) +0.65
 C = (3.00 x NB. PIN) +1.3

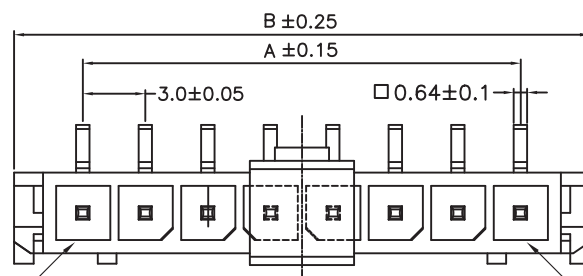
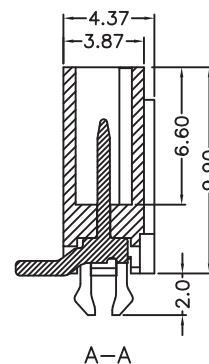
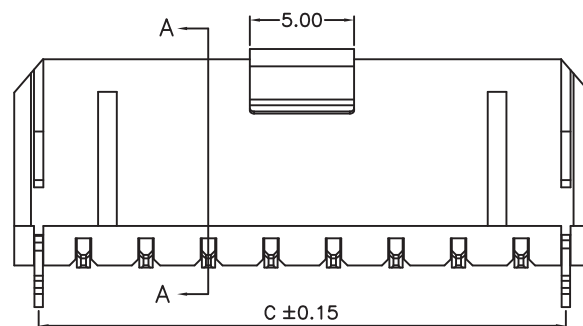
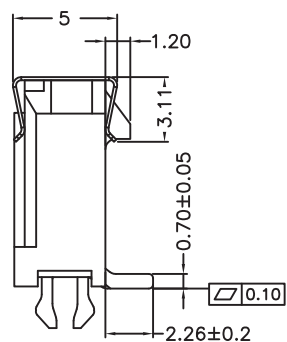

LAST CKT.

CKT.#1

RoHS Compliant

PROJECTION:



GENERAL TOLERANCE

.X = +/- 0.2

.XX = +/- 0.15



APPROVAL: BBu

UNIT: MM

SCALE:

SHEET: 1/3

DRAW: AK

DESCRIPTION: 3.00 MM SMT SINGLE ROW MALE VERTICAL HEADER WITH THROUGH HOLE RETENTION CLIPS

WERI PART NO: 662 3xx 135 922

SIZE

A4

F			
E			
D			
C			
B			
A	16-JUL-15	PDF	AK
REV	DATE	FILE	BY

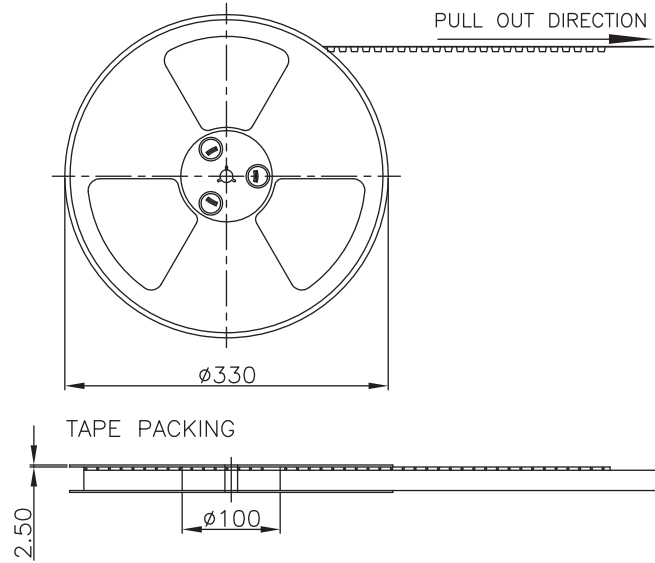

Pin No	W	F	PCS/R	R/CTN	Q'TY
02-03	24	11.5	250	9	2250
04	32	14.2	250	7	1750
05-08	44	20.2	250	5	1250
09-12	56	26.2	250	4	1000

Note:

- All dimensions meet EIA-481-3 requirements.
- Material: White Conductive Polystyrene Alloy
100% recyclable.
- Thickness: 0.50 ± 0.05 mm
- Carton Size: 350*350*296(mm)

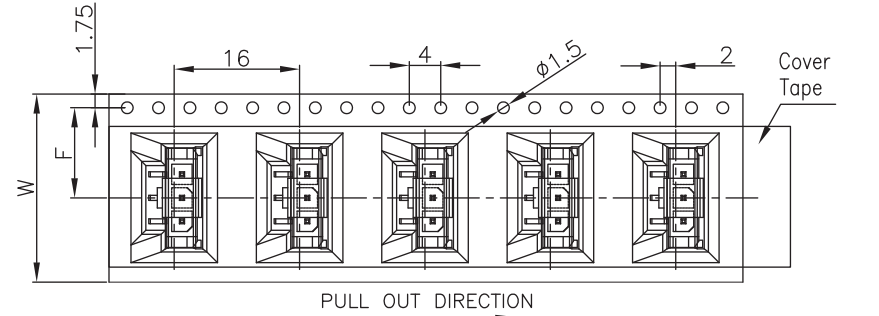
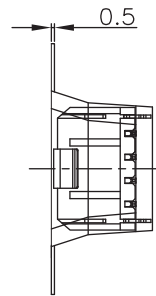
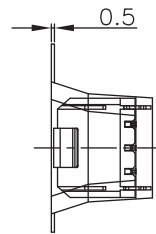

For Reel width (dimension W) 16,24mm Single row hole

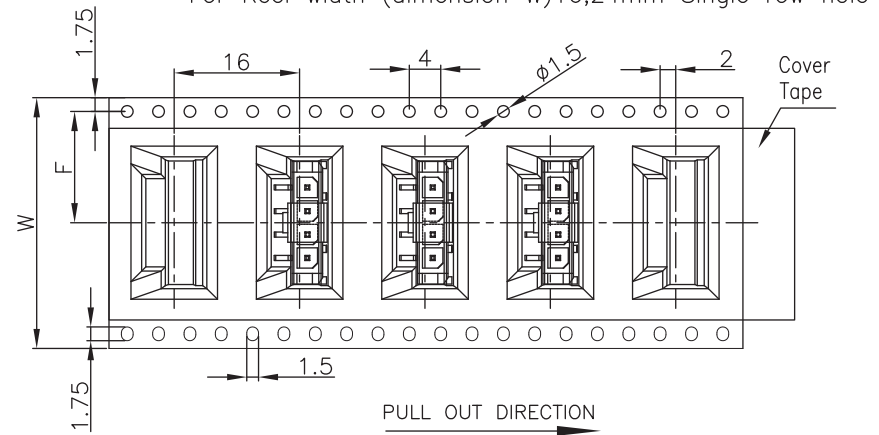

For Reel width (dimension W) 32,44,56,72mm Double rows hole

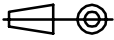
RoHS Compliant				PROJECTION:	GENERAL TOLERANCE		DESCRIPTION: 3.00 MM SMT SINGLE ROW MALE VERTICAL HEADER WITH THROUGH HOLE RETENTION CLIPS WERI PART NO: 662 3xx 135 922	SIZE A4
F					.X = ± 0.2			
E					.XX = ± 0.15			
D				APPROVAL: BBu	UNIT: MM			
C					SCALE:			
B					SHEET: 2/3			
A					DRAW: AK			
REV	DATE	FILE	BY					

1

2

3

4

5

Cautions and Warnings:

This electronic component is designed and developed with the intention for use in general electronics equipments.

Before incorporating the components into any equipments in the field such as aerospace, aviation, nuclear control, submarine, transportation, (automotive control, train control, ship control), transportation signal, disaster prevention, medical, public information network etc. where higher safety and reliability are especially required or if there is possibility of direct damage or injury to human body, Würth Elektronik must be asked for a written approval.



In addition, even electronic component in general electronic equipments, when used in electrical circuits that require high safety, reliability functions or performance, the sufficient reliability evaluation-check for the safety must be performed before by the user before usage.

A

B

C

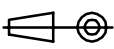
RoHS Compliant

G				PROJECTION: 	GENERAL TOLERANCE .X = +/- 0.2 .XX = +/- 0.15		
F							
E							
D							
C				APPROVAL: JC	UNIT: MM	DESCRIPTION: DISCLAIMER	SIZE A4
B					SCALE:		
A	10-SEP-14	PDF	QL		SHEET: 3/3	WERI PART NO: DISCLAIMER	
REV	DATE	FILE	BY		DRAW: QL		

D

X-ON Electronics

Largest Supplier of Electrical and Electronic Components

Click to view similar products for [Headers & Wire Housings](#) category:

Click to view products by [Wurth](#) manufacturer:

Other Similar products are found below :

[892-18-020-10-001101](#) [58102-G61-06LF](#) [582553-1](#) [0009485154](#) [009176003701906](#) [0050291907](#) [LY20-4P-DT1-P1E-BR](#) [02.125.8002.8](#)
[609-3404](#) [61062-3](#) [61082-181009](#) [622-3653LF](#) [63453-116](#) [636-1030](#) [636-1427](#) [636-3427](#) [636-4007](#) [641938-9](#) [641991-4](#) [644827-2](#) [65817-](#)
[010LF](#) [65817-015LF](#) [65863-015LF](#) [66207-023LF](#) [67095-007LF](#) [67601157](#) [68645-018](#) [68648-049](#) [70.362.1628.0](#) [70-4210](#) [70-4226B](#) [70-](#)
[4853B](#) [707-5020](#) [707-5028](#) [71.350.2428.0](#) [71918-208LF](#) [71961-016LF](#) [733-134](#) [733-162](#) [754199-000](#) [760-3052](#) [79531-3000](#) [FCN-](#)
[360C032-B](#) [FCN-367T-T012/H](#) [FCN-723D010/2](#) [80.063.4001.1](#) [800-90-010-10-002000](#) [801-43-002-10-013000](#) [801-43-006-10-002000](#)
[801-93-011-10-001000](#)