

1

2

3

4

5

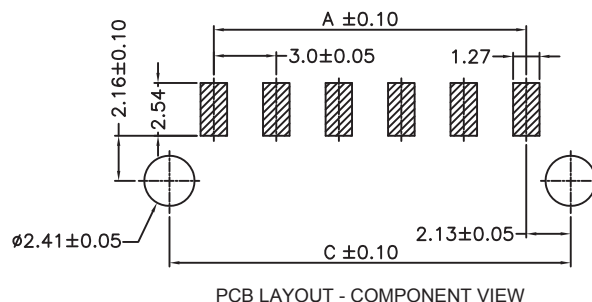

TECHNICAL CHARACTERISTICS

MATERIAL  
 INSULATOR: LCP  
 FLAMABILITY RATING: UL94-V0  
 COLOR: BLACK  
 CONTACT MATERIAL: COPPER ALLOY  
 CONTACT TYPE: STAMPED  
 CONTACT PLATING: TIN  
 QUALITY CLASS: 25 MATING CYCLES  
 PITCH: 3.00MM

ENVIRONMENTAL  
 OPERATING TEMPERATURE: -40 UP TO 105 °C  
 COMPLIANCE: LEAD FREE AND ROHS

ELECTRICAL  
 CURRENT RATING: 5A  
 WORKING VOLTAGE: 250 VAC  
 INSULATOR RESISTANCE: >1000 MOHM  
 DIELECTRIC WITHSTANDING VOLTAGE: 1500 VAC/MN  
 CONTACT RESISTANCE: 10 mOHM MAX

STANDARD  
 CERTIFIED: E323964

SOLDERING  
 JEDEC LEAD FREE REFLOW SOLDERING PROCESS

PACKAGING  
 TAPE AND REEL WITH CAP

DIMENSION  
 A = 3.00 x (NB. PIN -1)  
 B = 3.00 x (NB. PIN +1) +0.65  
 C = (3.00 x NB. PIN) +1.3

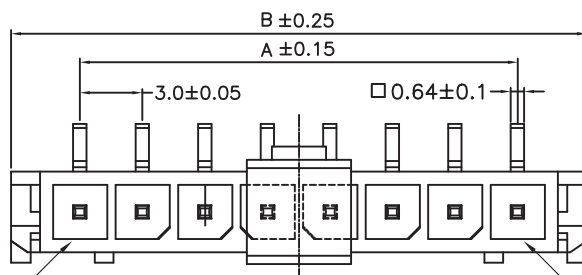
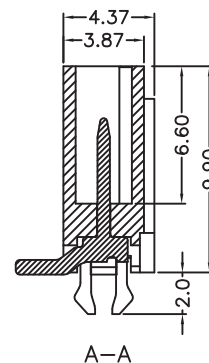
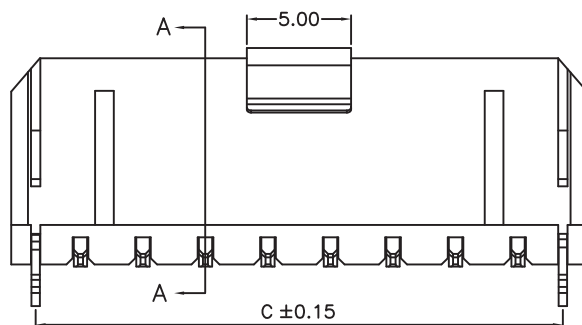
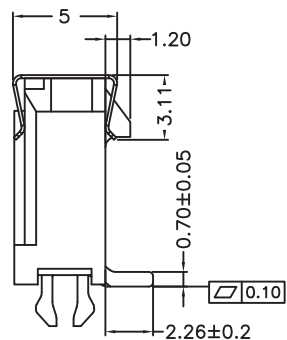

LAST CKT.

CKT.#1

RoHS Compliant			
F			
E			
D			
C			
B			
A	16-JUL-15	PDF	AK
REV	DATE	FILE	BY

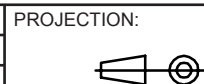

APPROVAL: BBu

GENERAL TOLERANCE

.X = +/- 0.2  
 .XX = +/- 0.15

UNIT: MM

SCALE:

SHEET: 1/3

DRAW: AK



DESCRIPTION: 3.00 MM SMT SINGLE ROW MALE VERTICAL HEADER WITH THROUGH HOLE RETENTION CLIPS

WERI PART NO: 662 3xx 135 922

SIZE

A4

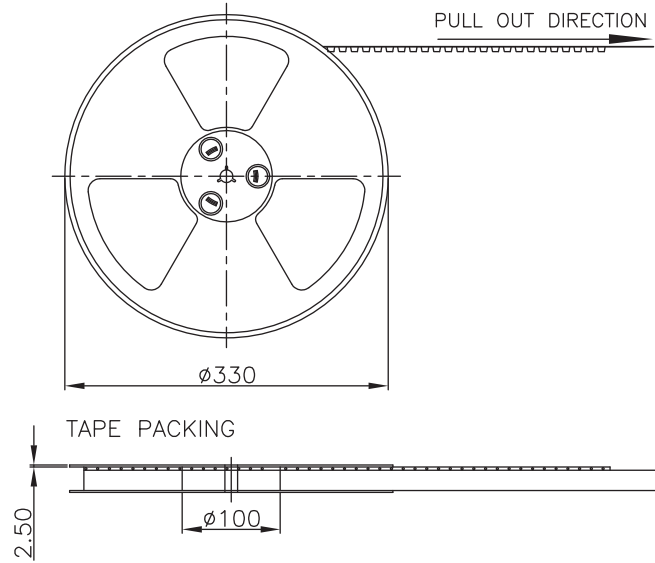

Pin No	W	F	PCS/R	R/CTN	Q'TY
02-03	24	11.5	250	9	2250
04	32	14.2	250	7	1750
05-08	44	20.2	250	5	1250
09-12	56	26.2	250	4	1000

Note:

- All dimensions meet EIA-481-3 requirements.
- Material: White Conductive Polystyrene Alloy  
100% recyclable.
- Thickness:  $0.50 \pm 0.05$ mm
- Carton Size: 350\*350\*296(mm)

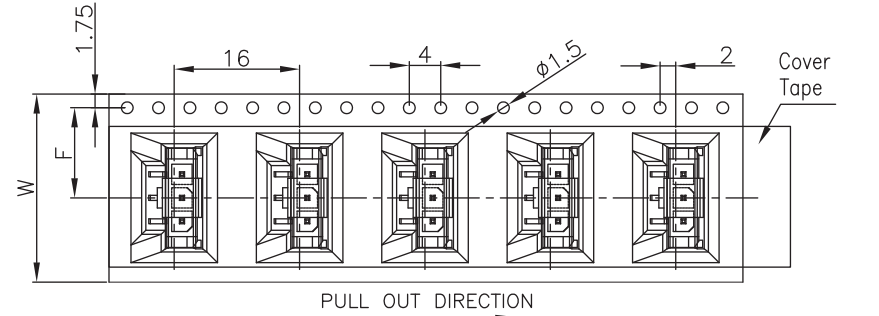
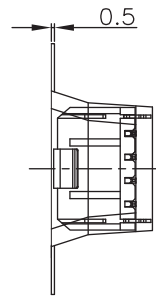
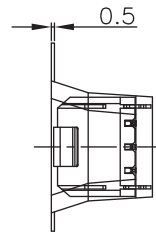

For Reel width (dimension W) 16,24mm Single row hole

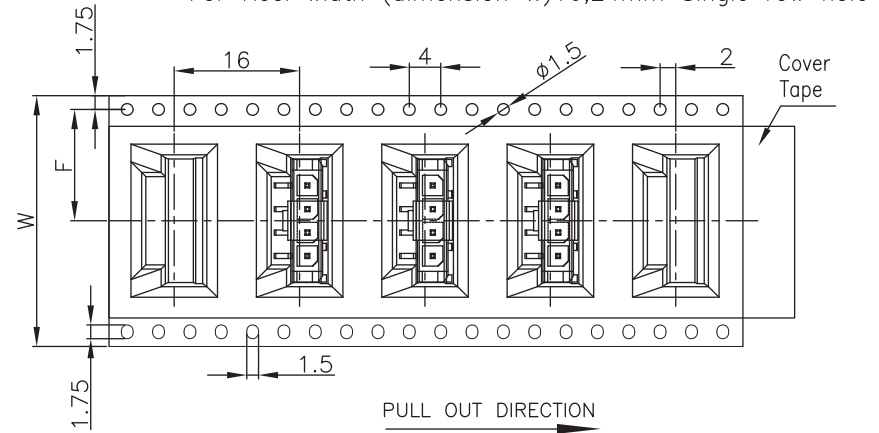

For Reel width (dimension W) 32,44,56,72mm Double rows hole

RoHS Compliant

F				
E				
D				
C				
B				
A				
REV	DATE	FILE	BY	

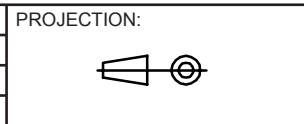

APPROVAL: BBu

GENERAL TOLERANCE  
.X =  $\pm 0.2$   
.XX =  $\pm 0.15$

UNIT: MM  
SCALE:  
SHEET: 2/3  
DRAW: AK



DESCRIPTION: 3.00 MM SMT SINGLE ROW MALE VERTICAL HEADER WITH THROUGH HOLE RETENTION CLIPS  
WERI PART NO: 662 3xx 135 922

SIZE  
**A4**

1

2

3

4

5

## Cautions and Warnings:

This electronic component is designed and developed with the intention for use in general electronics equipments.

Before incorporating the components into any equipments in the field such as aerospace, aviation, nuclear control, submarine, transportation, (automotive control, train control, ship control), transportation signal, disaster prevention, medical, public information network etc. where higher safety and reliability are especially required or if there is possibility of direct damage or injury to human body, Würth Elektronik must be asked for a written approval.

In addition, even electronic component in general electronic equipments, when used in electrical circuits that require high safety, reliability functions or performance, the sufficient reliability evaluation-check for the safety must be performed before by the user before usage.

A

B

C

RoHS Compliant

G				PROJECTION: 	GENERAL TOLERANCE .X = +/- 0.2 .XX = +/- 0.15		
F							
E							
D							
C				APPROVAL: JC	UNIT: MM	DESCRIPTION: DISCLAIMER	SIZE <b>A4</b>
B					SCALE:		
A	10-SEP-14	PDF	QL		SHEET: 3/3	WERI PART NO: DISCLAIMER	
REV	DATE	FILE	BY		DRAW: QL		

D

## X-ON Electronics

Largest Supplier of Electrical and Electronic Components

*Click to view similar products for [Headers & Wire Housings](#) category:*

*Click to view products by [Würth](#) manufacturer:*

Other Similar products are found below :

[892-18-020-10-001101](#) [58102-G61-06LF](#) [582553-1](#) [0009485154](#) [009176003701906](#) [0050291907](#) [LY20-4P-DT1-P1E-BR](#) [02.125.8002.8](#)  
[609-3404](#) [61062-3](#) [61082-181009](#) [622-3653LF](#) [63453-116](#) [636-1030](#) [636-1427](#) [636-3427](#) [636-4007](#) [641938-9](#) [641991-4](#) [644827-2](#) [65817-010LF](#) [65817-015LF](#) [65863-015LF](#) [66207-023LF](#) [67095-007LF](#) [67601157](#) [68645-018](#) [68648-049](#) [70.362.1628.0](#) [70-4210](#) [70-4226B](#) [70-4853B](#) [707-5020](#) [707-5028](#) [71.350.2428.0](#) [71918-208LF](#) [71961-016LF](#) [733-134](#) [733-162](#) [754199-000](#) [760-3052](#) [787-8014-00](#) [79531-3000](#)  
[FCN-360C032-B](#) [FCN-367T-T012/H](#) [FCN-723D010/2](#) [80.063.4001.1](#) [800-90-001-10-001000](#) [800-90-010-10-002000](#) [801-43-002-10-013000](#)