

# Product/Process Change Notice (PCN)



- Major change  
 Minor change

PCN #: ConFPC\_140401

Product Affected: 6861xx14422, 6861xx14122,  
6863xx124422, 6871xx14522,  
6871xx14022, 6873xx124422

- Product Mark  
 Date Code  
 Packaging  
 Others

Effective Date: 2014-04-01

Contact: Product Management

Tel: +49 7942 945-5001

Fax: +49 7942 945-5179

E-mail: [PCN.eican@we-online.de](mailto:PCN.eican@we-online.de)

Attachment:  Yes  No

Samples: No

## DESCRIPTION AND PURPOSE OF CHANGE:

We changed the width of the reel on FPC connector for some polarities. It is because of the presence of cap on the FPC connectors. So we had to adapt the place for the pieces in the reel. At the beginning there was no cap on the connectors, so now the width for some polarities was changed.

68610414422	68610414122	686304124422	68710414522	68710414022	687304124422
68610514422	68610614122	686305124422	68710514522	68710614022	687306124422
68610614422	68610814122	686306124422	68710614522	68710814022	687308124422
68610814422	68611014122	686307124422	68710814522	68711014022	687309124422
68610914422	68611114122	686308124422	68711014522	68711214022	687310124422
68611014422	68611214122	686309124422	68711214522	68711414022	687312124422
68611114422	68611414122	686310124422	68711414522	68711614022	687314124422
68611214422	68611514122	686311124422	68711614522	68711714022	687316124422
68611414422	68611614122	686312124422	68711714522	68711814022	687318124422
68611514422	68611814122	686313124422	68711814522	68712014022	687320124422
68611614422	68612014122	686314124422	68712014522	68712214022	687322124422
68611814422	68612214122	686315124422	68712214522	68712414022	687324124422
68612014422	68612414122	686316124422	68712414522	68712514022	687326124422
68612214422	68612614122	686317124422	68712614522	68712614022	687328124422
68612414422	68612814122	686318124422	68712814522	68712814022	687330124422
68612614422	68613014122	686319124422	68713014522	68713014022	687333124422
68612814422		686320124422	68713214522	68713214022	687334124422
68613014422		686321124422	68713314522	68713314022	687340124422
		686322124422	68713414522	68713414022	687350124422
		686323124422	68713514522	68713514022	
		686324124422	68713614522	68713614022	
		686325124422	68714014522	68714014022	
		686326124422	68714414522	68714414022	
		686327124422	68714514522	68714514022	
		686328124422	68715014522	68715014022	

## RELIABILITY / QUALIFICATION SUMMARY:

N / A

DATA SHEET CHANGE:

Yes

No

**Würth Elektronik**

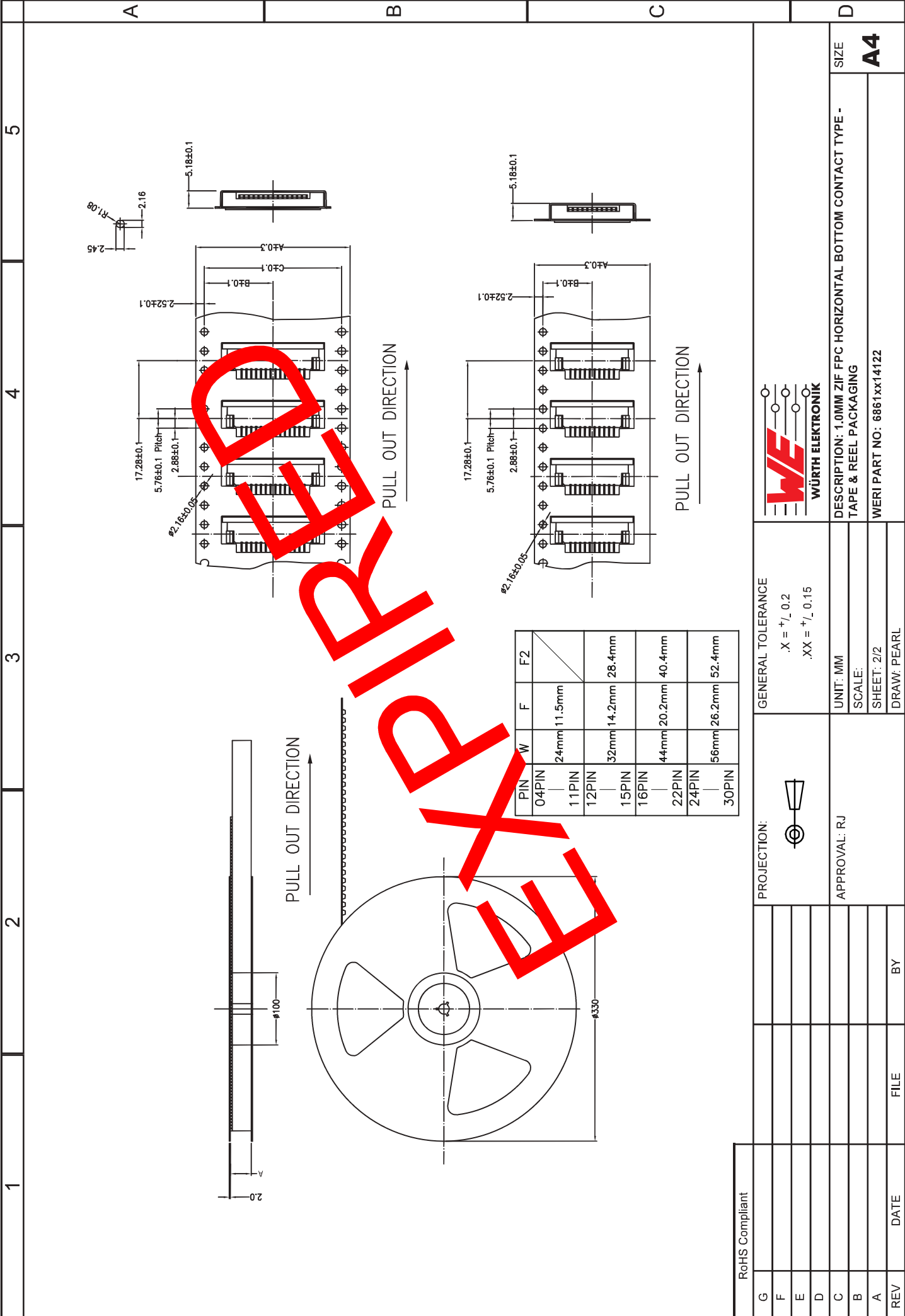

DRAFT



DESCRIPTION: 1.0MM ZIF FPC HORIZONTAL BOTTOM CONTACT TYPE - TAPE & REEL PACKAGING  
 WERI PART NO: 6861xx14122

GENERAL TOLERANCE  
 .X = +<sub>-</sub> 0.2  
 .XX = +<sub>-</sub> 0.15

UNIT: MM  
 SCALE:  
 SHEET: 2/2  
 DRAW: PEARL

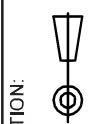



APPROVAL: RJ

RoHS Compliant					
G					
F					
E					
D					
C					
B					
A					
REV	DATE	FILE	BY		

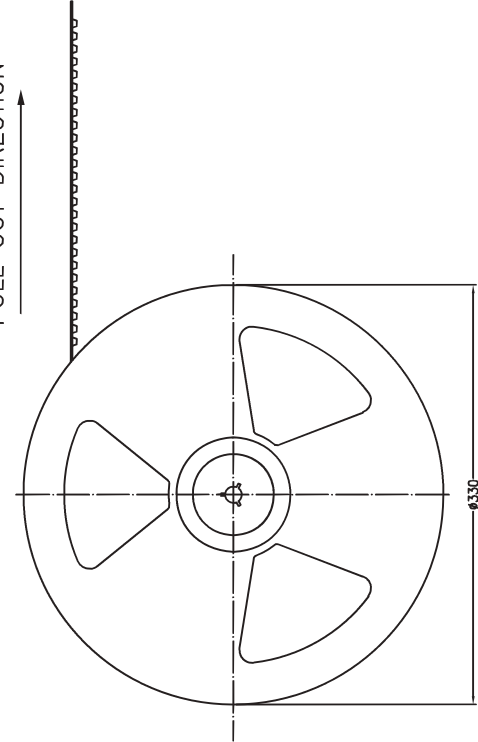
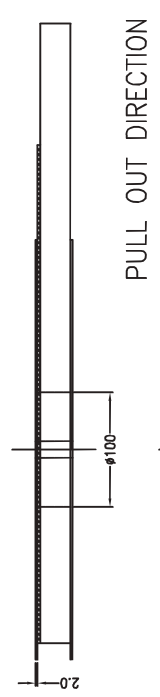
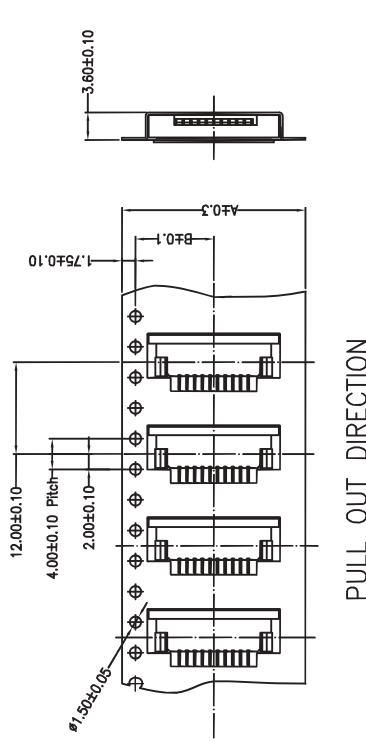
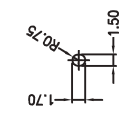
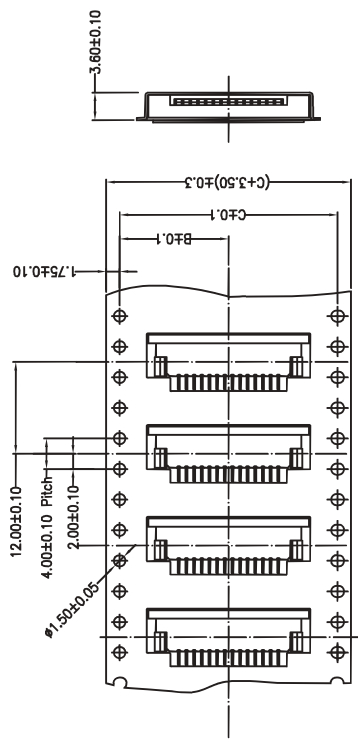
SIZE  
**A4**



	4-9 PIN	10-14 PIN	15-26 PIN	27-30 PIN
DIM.B	11.50	14.20	20.20	26.20
DIM.C	---	28.40	40.40	52.40
TAPE/CARTON	8PCS	6PCS	5PCS	4PCS

RoHS Compliant		GENERAL TOLERANCE .X = +/_ 0.2 .XX = +/_ 0.15		 <b>WÜRTH ELEKTRONIK</b>	
G		PROJECTION:			
F		APPROVAL: RJ		DESCRIPTION: 1.0MM ZIF FPC HORIZONTAL BOTTOM CONTACT TYPE - TAPE & REEL PACKAGING	
E		DATE		UNIT: MM SCALE:	
D		FILE		SHEET: 2/2	
C		BY		DRAW: PEARL	
B				WERI PART NO: 6861xx14122	
A				SIZE	
REV				<b>A4</b>	

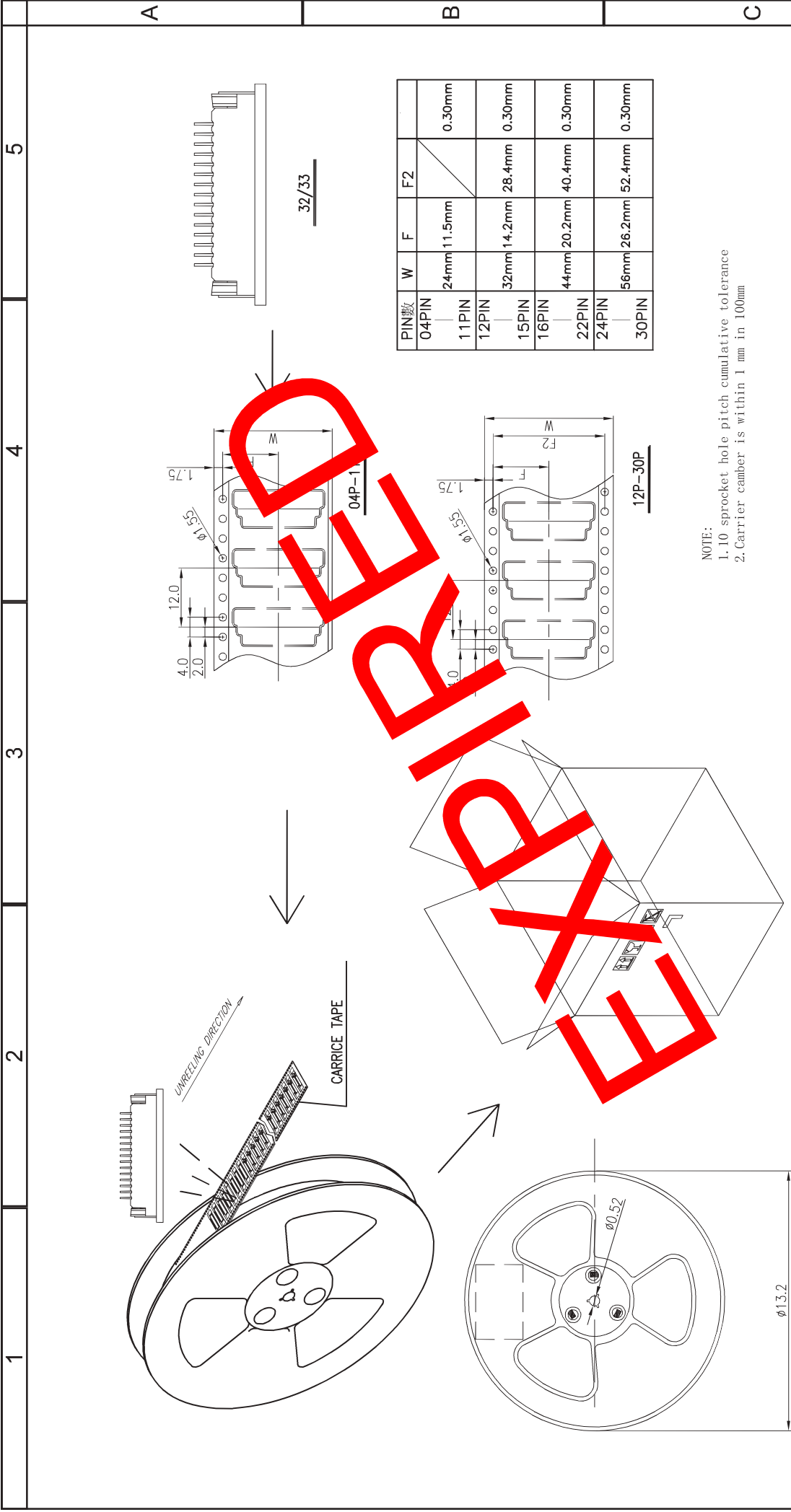

RoHS Compliant		GENERAL TOLERANCE		 <b>WÜRTH ELEKTRONIK</b>		<b>DESCRIPTION: 1.0MM ZIF FPC HORIZONTAL BOTTOM CONTACT TYPE - TAPE &amp; REEL PACKAGING</b>		<b>SIZE</b> <b>A4</b>	
G		.X = + $\sqrt{}$ , 0.2 .XX = + $\sqrt{}$ , 0.15				UNIT: MM SCALE:		WERI PART NO: 6861 xx 14422	
F		APPROVAL: RJ				SHEET: 2/2		DRAW: PEARL	
E		CH							
D	29-JUL-08	MODIFICATIONS		EC					
C	26-NOV-07	CHARACTERISTIC		EC					
B	14-MAR-07	PDF		JP					
A	02-OCT-06	FILE		BY					
REV	DATE								

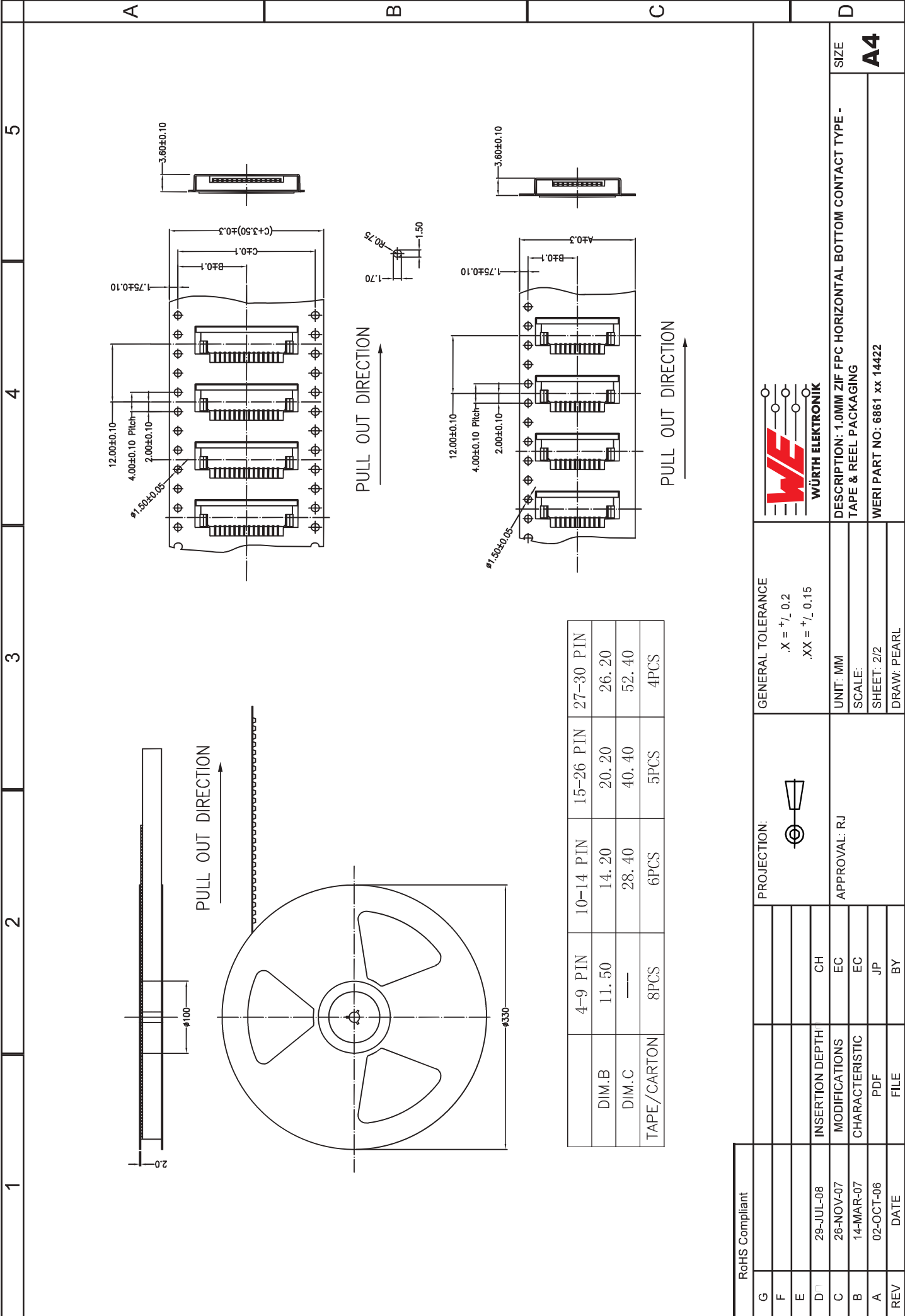

1

2

3

4

5

RoHS Compliant

G	
F	
E	
D	29-JUL-08
C	26-NOV-07
B	14-MAR-07
A	02-OCT-06
REV	DATE

INSERTION DEPTH	CH
MODIFICATIONS	EC
CHARACTERISTIC	EC
PDF	JP
FILE	BY

PROJECTION:	
APPROVAL:	RJ

GENERAL TOLERANCE	.X = + <sub>-</sub> 0.2 .XX = + <sub>-</sub> 0.15
UNIT:	MM
SCALE:	
SHEET:	2/2
DRAW:	PEARL



DESCRIPTION: 1.0MM ZIF FPC HORIZONTAL BOTTOM CONTACT TYPE - TAPE & REEL PACKAGING  
WERI PART NO: 6861 xx 14422

SIZE  
**A4**

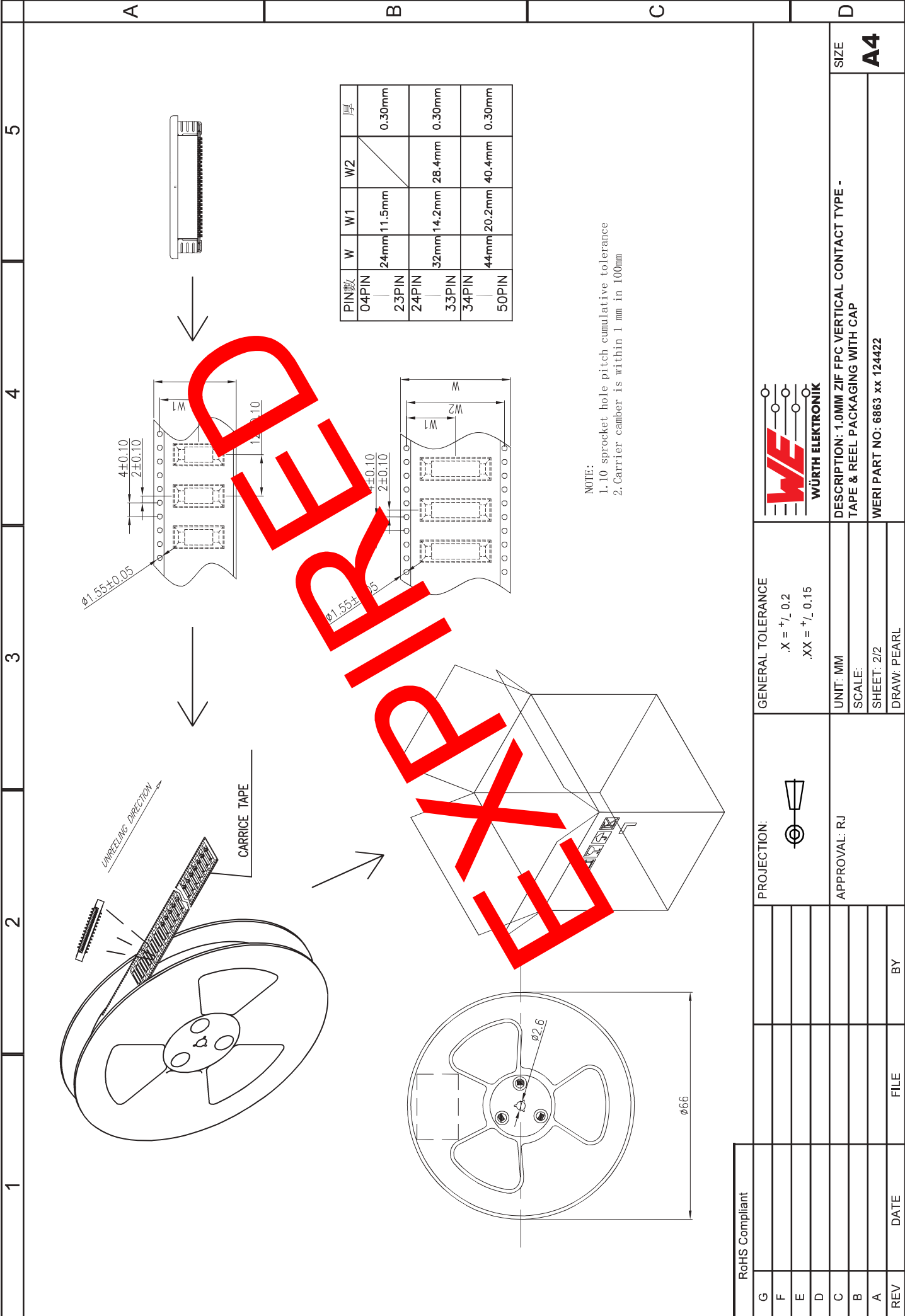

PIN数	W	W1	W2	厚
04PIN	24mm	11.5mm		0.30mm
23PIN				
24PIN	32mm	14.2mm	28.4mm	0.30mm
33PIN				
34PIN	44mm	20.2mm	40.4mm	0.30mm
50PIN				

NOTE:  
 1. 1.0 sprocket hole pitch cumulative tolerance  
 2. Carrier camber is within 1 mm in 100mm

RoHS Compliant	
G	
F	
E	
D	
C	
B	
A	
REV	DATE FILE BY

GENERAL TOLERANCE	.X = +0.2 .XX = +0.15
PROJECTION:	
UNIT: MM	
SCALE:	
SHEET: 2/2	
DRAW: PEARL	
APPROVAL: RJ	

		DESCRIPTION: 1.0MM ZIF FPC VERTICAL CONTACT TYPE - TAPE & REEL PACKAGING WITH CAP	SIZE
		WERI PART NO: 6863 xx 124422	<b>A4</b>

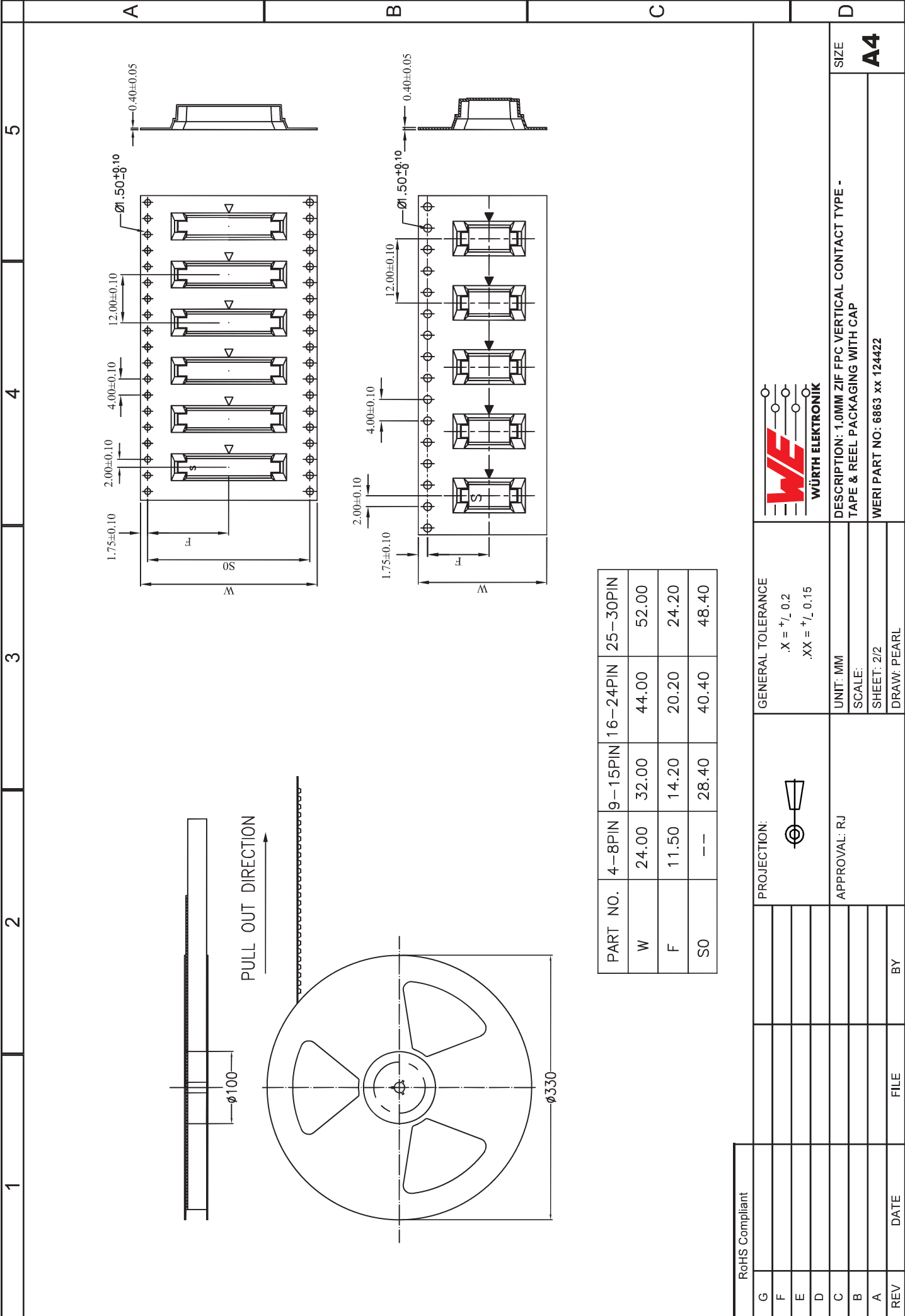

PART NO.	4-8PIN	9-15PIN	16-24PIN	25-30PIN
W	24.00	32.00	44.00	52.00
F	11.50	14.20	20.20	24.20
SO	--	28.40	40.40	48.40

RoHS Compliant		
G		
F		
E		
D		
C		
B		
A		
REV	DATE	BY

GENERAL TOLERANCE	$.X = \begin{matrix} + \\ - \end{matrix} 0.2$ $.XX = \begin{matrix} + \\ - \end{matrix} 0.15$	
UNIT: MM		
SCALE:		
SHEET: 2/2		
DRAW: PEARL		

**WE**  
**WÜRTH ELEKTRONIK**

DESCRIPTION: 1.0MM ZIF FPC VERTICAL CONTACT TYPE - TAPE & REEL PACKAGING WITH CAP  
 WERI PART NO: 6863 xx 124422

UNIT: MM  
 SCALE:  
 SHEET: 2/2  
 DRAW: PEARL

SIZE  
**A4**

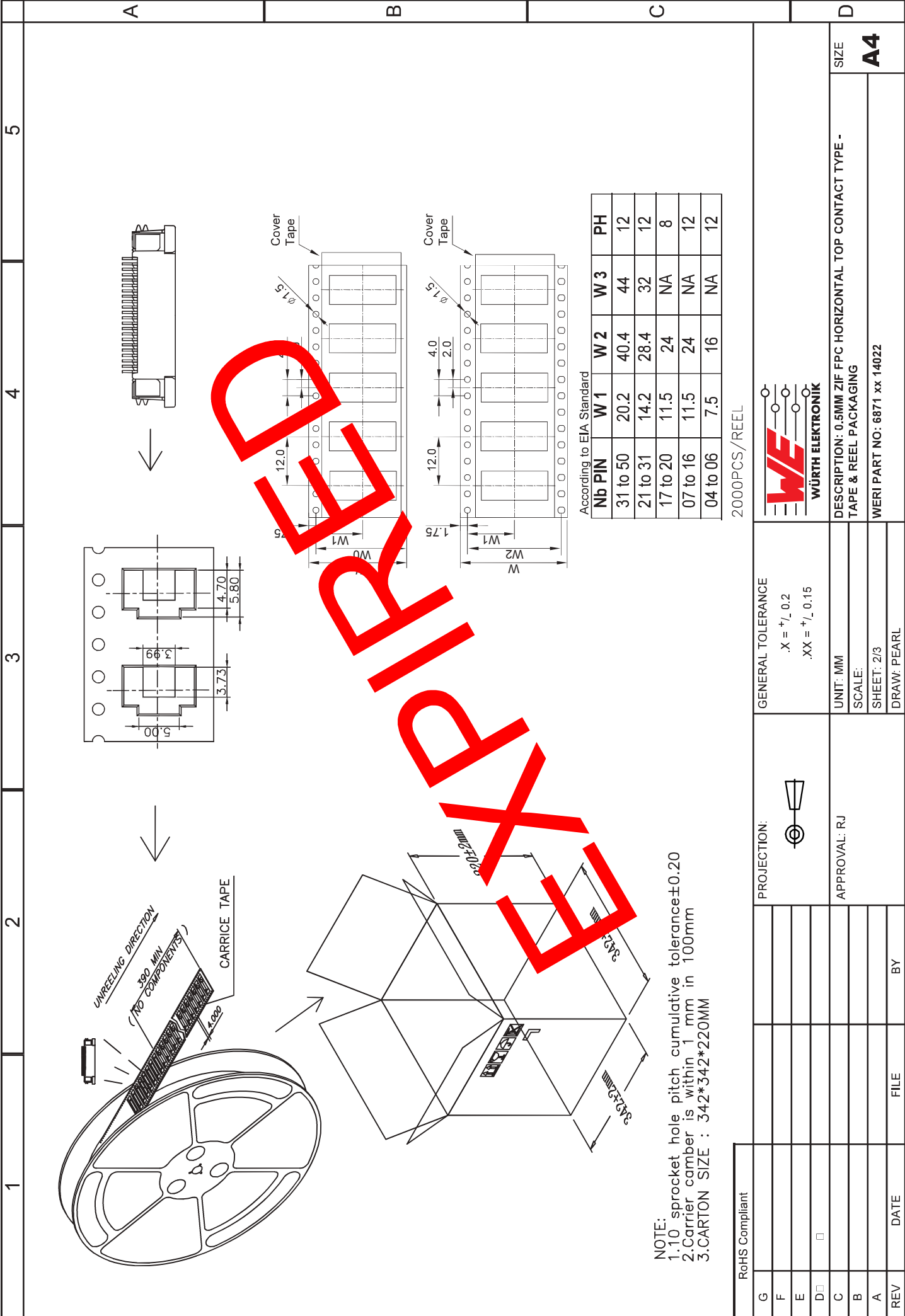

NOTE:  
 1. 1.10 sprocket hole pitch cumulative tolerance  $\pm 0.20$   
 2. Carrier camber is within 1 mm in 100mm  
 3. CARTON SIZE : 342\*342\*220MM

According to EIA Standard

Nb PIN	W 1	W 2	W 3	PH
31 to 50	20.2	40.4	44	12
21 to 31	14.2	28.4	32	12
17 to 20	11.5	24	NA	8
07 to 16	11.5	24	NA	12
04 to 06	7.5	16	NA	12

2000PCS/REEL



**WÜRTH ELEKTRONIK**  
 DESCRIPTION: 0.5MM ZIF FPC HORIZONTAL TOP CONTACT TYPE - TAPE & REEL PACKAGING  
 WERI PART NO: 6871 xx 14022

GENERAL TOLERANCE  
 .X =  $\pm$ , 0.2  
 .XX =  $\pm$ , 0.15

UNIT: MM  
 SCALE:  
 SHEET: 2/3  
 DRAW: PEARL



APPROVAL: RJ

RoHS Compliant

REV	DATE	FILE	BY
G			
F			
E			
D			
C			
B			
A			

SIZE  
**A4**



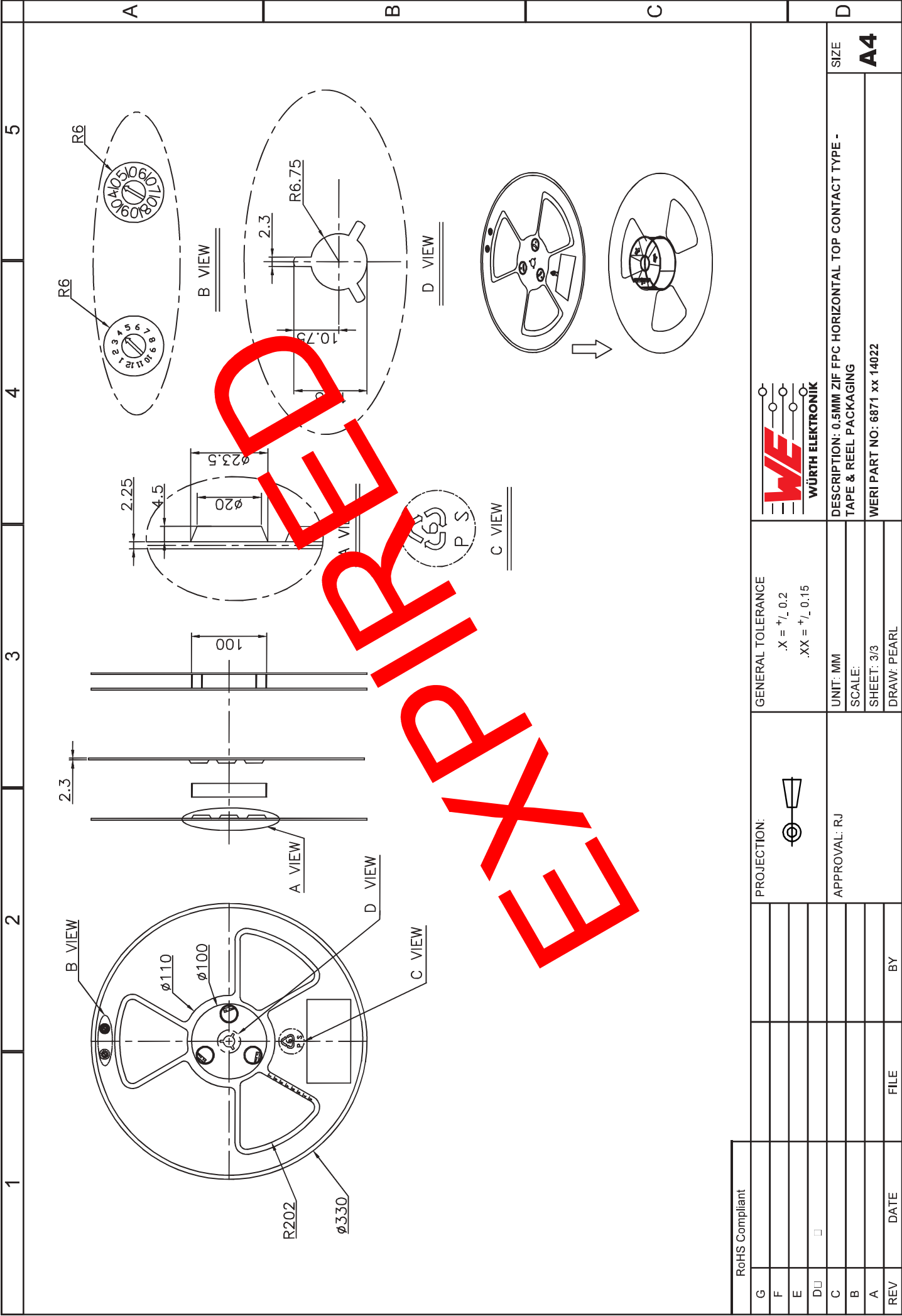

RoHS Compliant					
G					
F					
E					
DU	<input type="checkbox"/>				
C					
B					
A					
REV	DATE	FILE	BY		

GENERAL TOLERANCE  
.X = +<sub>-</sub> 0,2  
.XX = +<sub>-</sub> 0,15



DESCRIPTION: 0.5MM ZIF FPC HORIZONTAL TOP CONTACT TYPE -  
TAPE & REEL PACKAGING  
WERI PART NO: 6871 xx 14022

UNIT: MM  
SCALE:  
SHEET: 3/3  
DRAW: PEARL



PROJECTION:  

APPROVAL: RJ

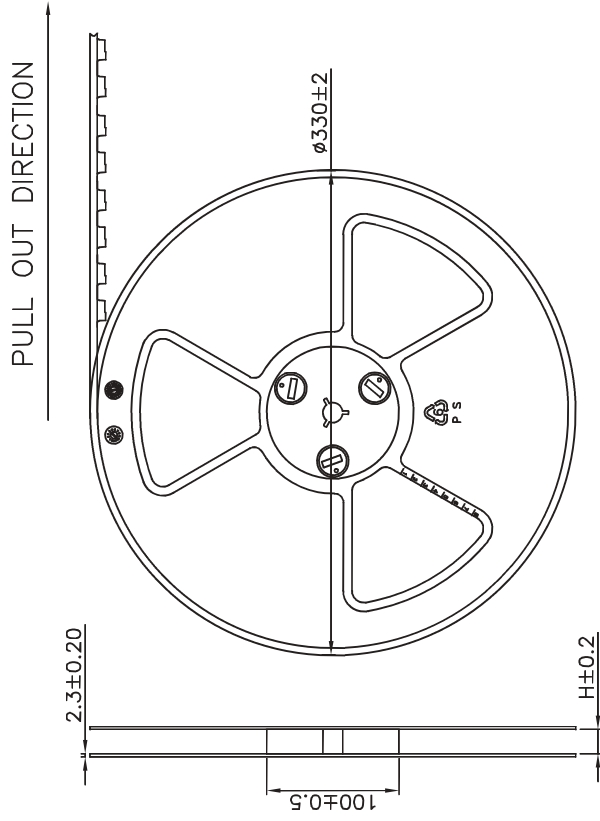
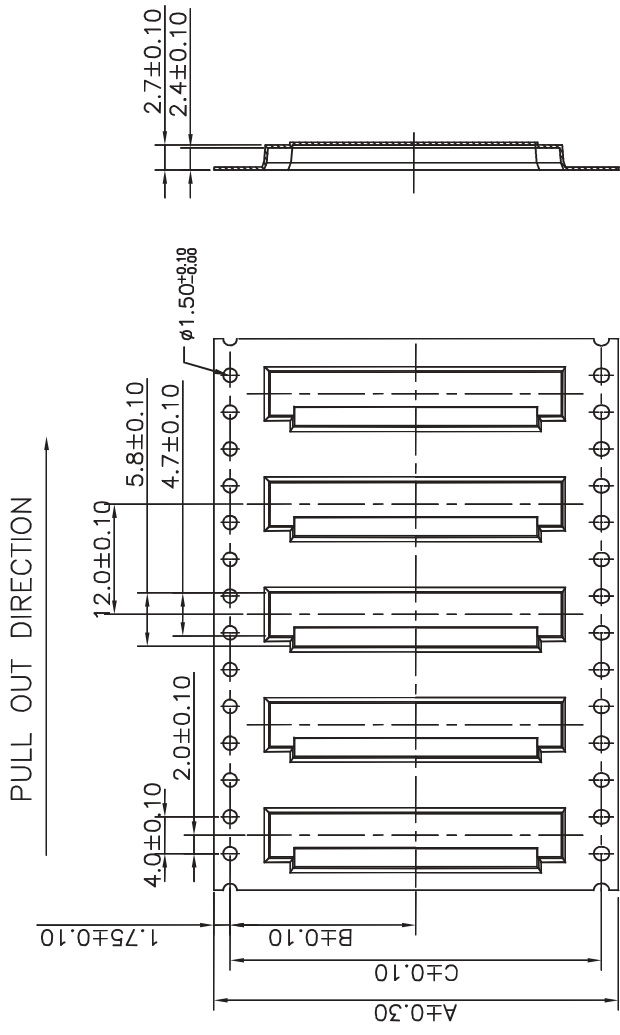
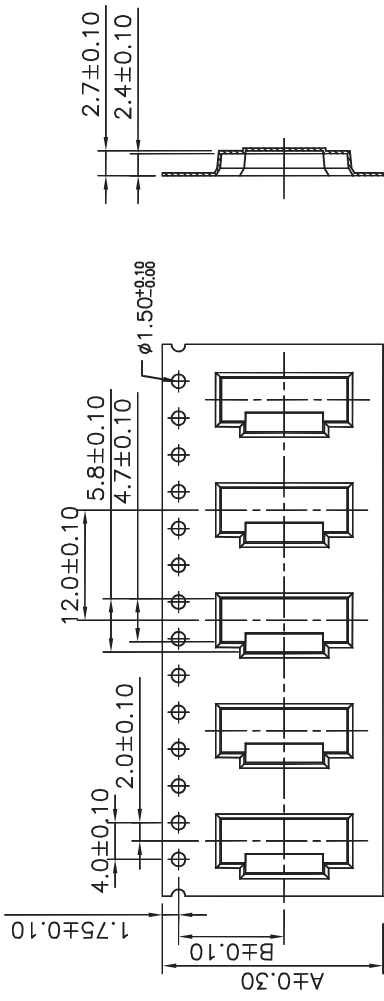

SIZE  
**A4**



Dimension	4-6 PIN	8-20 PIN	22-30 PIN	32-50 PIN	32-50 PIN
A	16	24	32	44	44
B	7.5	11.5	14.2	20.2	20.2
C	/	/	28.4	40.4	40.4
H	16.5	24.5	32.5	44.5	44.5
RFFL/CTN	9	7	5	4	4



RoHS Compliant		GENERAL TOLERANCE .X = +, 0.2 .XX = +, 0.15		 <b>WÜRTH ELEKTRONIK</b>		DESCRIPTION: 0.5MM ZIF FPC HORIZONTAL TOP CONTACT TYPE - TAPE & REEL PACKAGING WERI PART NO: 6871 xx 14022		SIZE <b>A4</b>	
G		PROJECTION:				UNIT: MM		DRAW: PEARL	
F		APPROVAL: RJ				SCALE:			
E						SHEET: 2/3			
D	□					FILE		BY	
C						DATE			
B									
A									

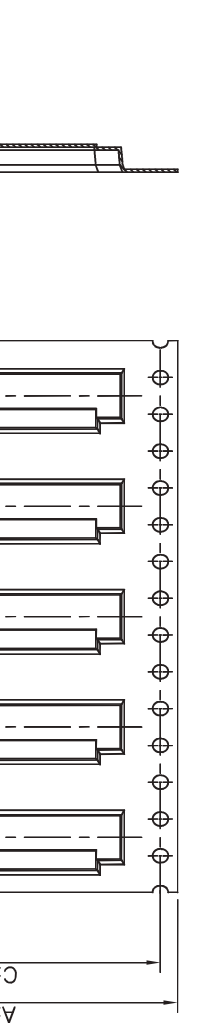
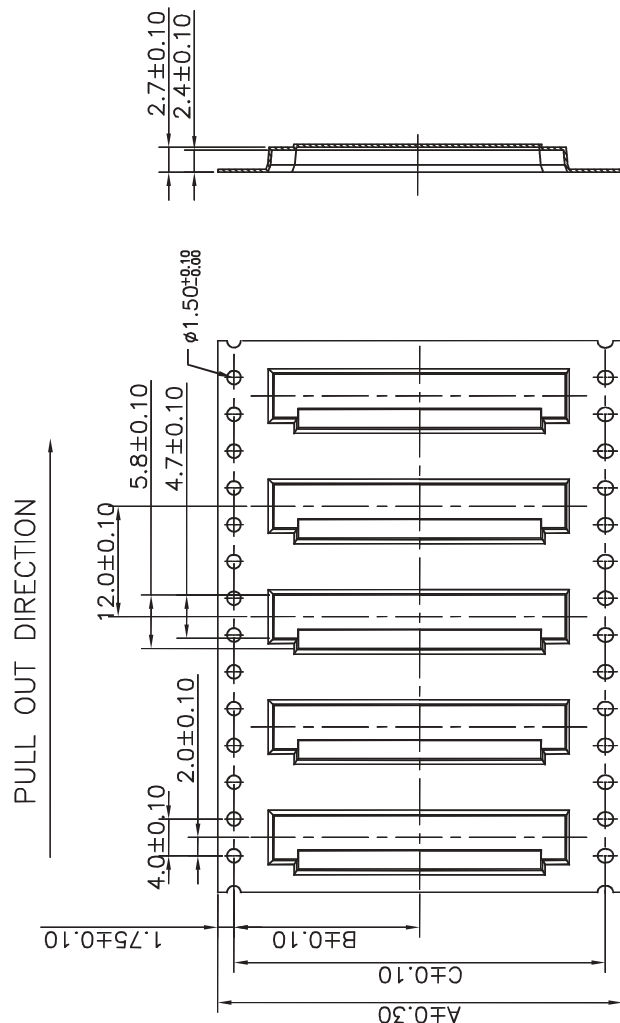
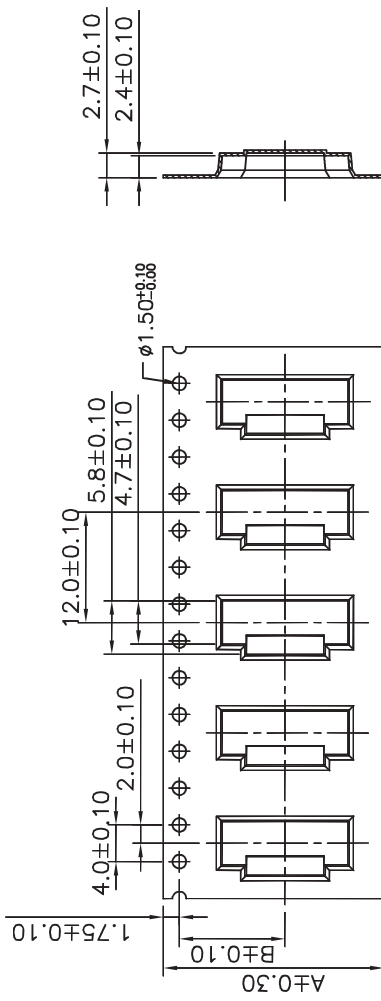
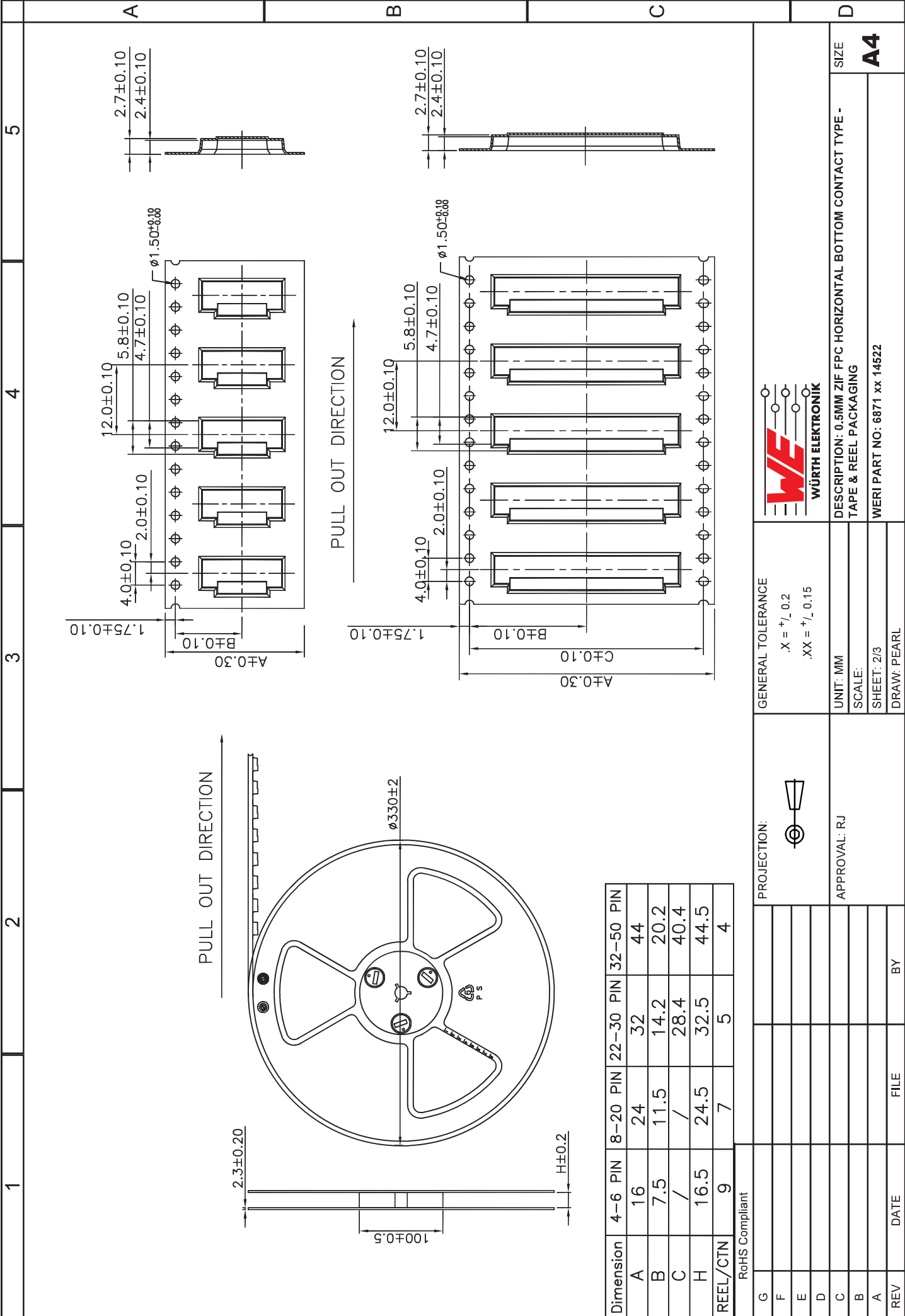

1	2	3	4	5
RoHS Compliant G F E D C B A REV	GENERAL TOLERANCE .X = $\pm 0.2$ .XX = $\pm 0.15$ UNIT: MM SCALE: SHEET: 3/3 DRAW: PEARL	PROJECTION:  APPROVAL: RJ	 <b>WÜRTH ELEKTRONIK</b> DESCRIPTION: 0.5MM ZIF FPC HORIZONTAL BOTTOM CONTACT TYPE - TAPE & REEL PACKAGING WERI PART NO: 6871 xx 14522	SIZE <b>A4</b>



Dimension	4-6 PIN	8-20 PIN	22-30 PIN	32-50 PIN	44
A	16	24	32	44	44
B	7.5	11.5	14.2	20.2	20.2
C	/	/	28.4	40.4	40.4
H	16.5	24.5	32.5	44.5	44.5
REEL/CTN	9	7	5	4	4

RoHS Compliant		GENERAL TOLERANCE .X = +, 0.2 .XX = +, 0.15		 <b>WÜRTH ELEKTRONIK</b>		DESCRIPTION: 0.5MM ZIF FPC HORIZONTAL BOTTOM CONTACT TYPE - TAPE & REEL PACKAGING WERI PART NO: 6871 xx 14522		SIZE <b>A4</b>	
G		PROJECTION:				UNIT: MM		DRAW: PEARL	
F		APPROVAL: RJ				SCALE:			
E						SHEET: 2/3			
D									
C									
B									
A									
REV	DATE	FILE	BY						

1	2	3	4	5																																													
<p>NOTE:</p> <ol style="list-style-type: none"> <li>1.10 sprocket hole pitch cumulative tolerance±0.2</li> <li>2.Carrier camber is within 1 mm in 100mm</li> <li>3.CARTON SIZE : 342*342*220MM</li> </ol>																																																	
<h1 style="color: red; opacity: 0.5;">REFUSED</h1>																																																	
<p>WÜRTH ELEKTRONIK</p> <p>DESCRIPTION: 0.5MM ZIF FPC VERTICAL CONTACT A TYPE - TAPE &amp; REEL PACKAGING WITH CAP</p> <p>WERI PART NO: 6873 xx 124422</p>																																																	
<p>GENERAL TOLERANCE</p> <p>.X = +<sub>L</sub> 0.2</p> <p>.XX = +<sub>L</sub> 0.15</p>																																																	
<p>UNIT: MM</p> <p>SCALE:</p> <p>SHEET: 2/3</p> <p>DRAW: PEARL</p>																																																	
<p>PROJECTION:</p> <p>APPROVAL: RJ</p>																																																	
<table border="1"> <tr> <td>RoHS Compliant</td> <td></td> <td></td> <td></td> <td></td> </tr> <tr> <td>G</td> <td></td> <td></td> <td></td> <td></td> </tr> <tr> <td>F</td> <td></td> <td></td> <td></td> <td></td> </tr> <tr> <td>E</td> <td></td> <td></td> <td></td> <td></td> </tr> <tr> <td>D</td> <td></td> <td></td> <td></td> <td></td> </tr> <tr> <td>C</td> <td></td> <td></td> <td></td> <td></td> </tr> <tr> <td>B</td> <td></td> <td></td> <td></td> <td></td> </tr> <tr> <td>A</td> <td></td> <td></td> <td></td> <td></td> </tr> <tr> <td>REV</td> <td>DATE</td> <td>FILE</td> <td>BY</td> <td></td> </tr> </table>					RoHS Compliant					G					F					E					D					C					B					A					REV	DATE	FILE	BY	
RoHS Compliant																																																	
G																																																	
F																																																	
E																																																	
D																																																	
C																																																	
B																																																	
A																																																	
REV	DATE	FILE	BY																																														

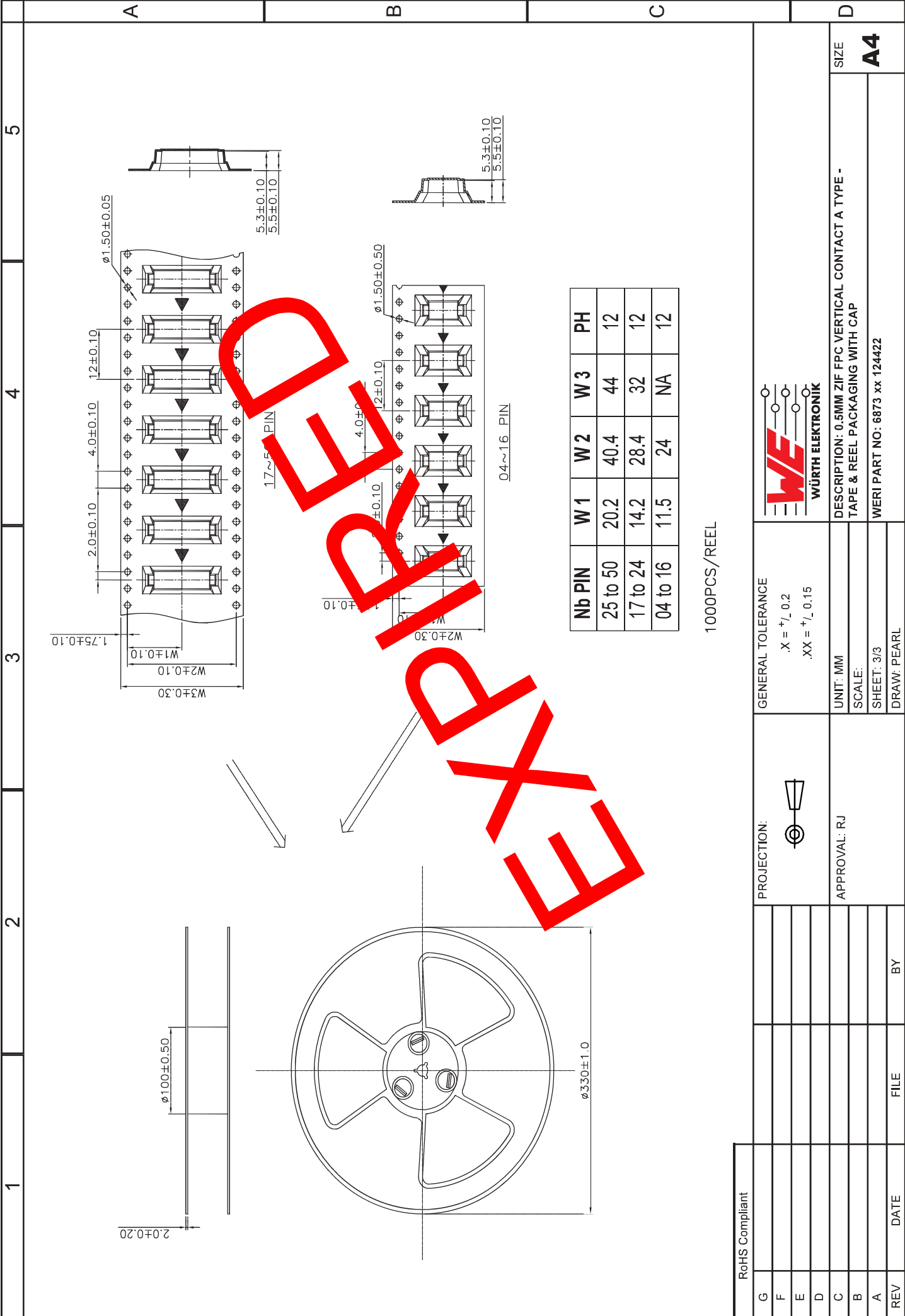

1000PCS/REEL

RoHS Compliant					
G					
F					
E					
D					
C					
B					
A					
REV	DATE	FILE	BY		

GENERAL TOLERANCE .X = + <sub>L</sub> 0.2 .XX = + <sub>L</sub> 0.15	PROJECTION: 	APPROVAL: RJ
UNIT: MM		
SCALE:		
SHEET: 3/3		
DRAW: PEARL		



DESCRIPTION: 0.5MM ZIF FPC VERTICAL CONTACT A TYPE - TAPE & REEL PACKAGING WITH CAP  
WERI PART NO: 6873 xx 124422

SIZE  
**A4**

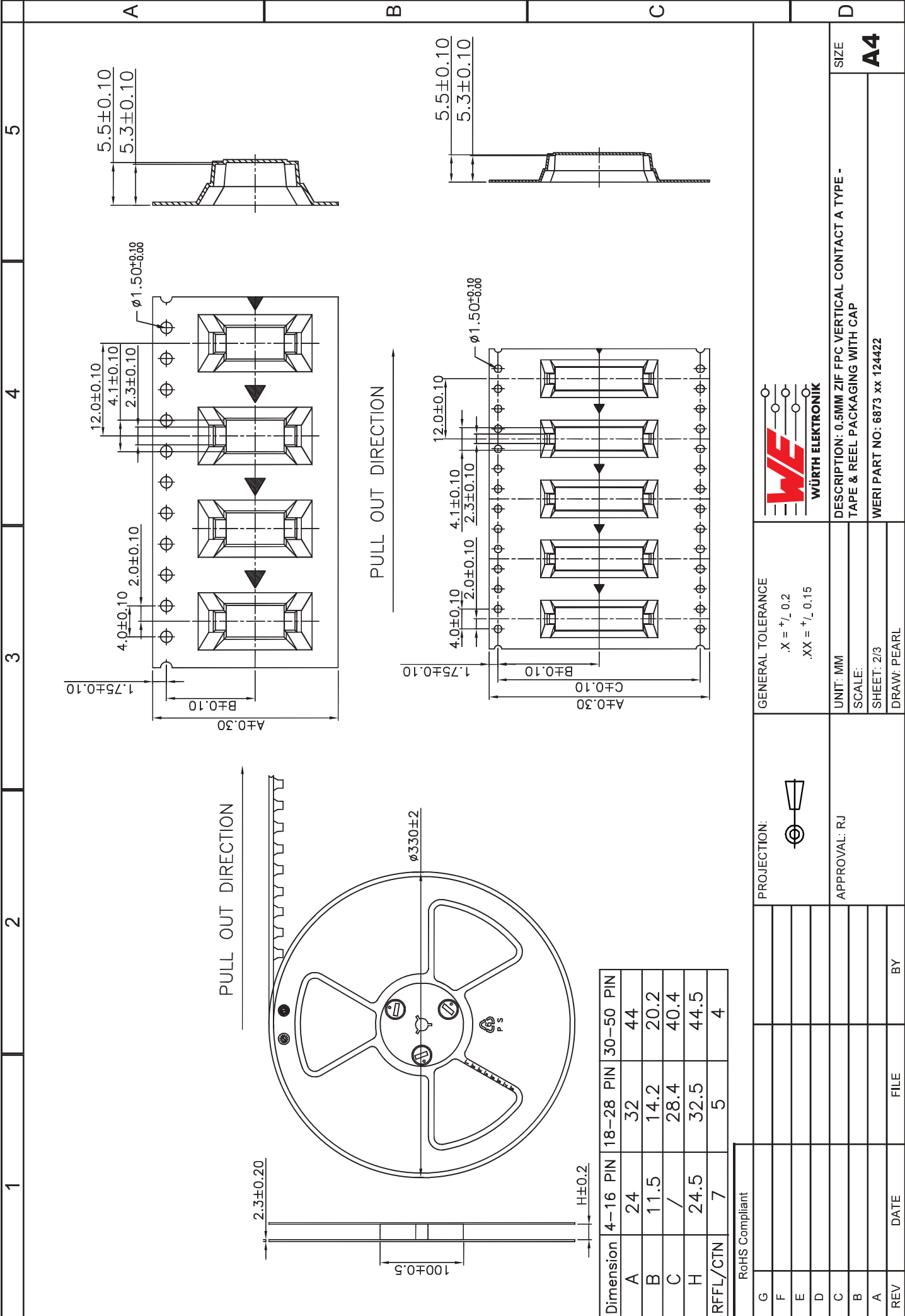

Dimension	4-16 PIN	18-28 PIN	30-50 PIN
A	24	32	44
B	11.5	14.2	20.2
C	/	28.4	40.4
H	24.5	32.5	44.5
RFFL/CTN	7	5	4

RoHS Compliant

G				
F				
E				
D				
C				
B				
A				
REV	DATE	FILE	BY	

GENERAL TOLERANCE

.X = +, 0.2  
.XX = +, 0.15



DESCRIPTION: 0.5MM ZIF FPC VERTICAL CONTACT A TYPE - TAPE & REEL PACKAGING WITH CAP  
WERI PART NO: 6873 xx 124422

SIZE  
**A4**

UNIT: MM  
SCALE:  
SHEET: 2/3  
DRAW: PEARL



## X-ON Electronics

Largest Supplier of Electrical and Electronic Components

*Click to view similar products for [FFC & FPC Connectors](#) category:*

*Click to view products by [Würth](#) manufacturer:*

Other Similar products are found below :

[HFW11R-1STE1H1LF](#) [FH29B-100S-0.2SHW\(99\)](#) [FA5S008HP1](#) [FH29B-120S-0.2SHW\(99\)](#) [FH29B-80S-0.2SHW\(99\)](#) [FHS-16](#) [FPH-2022G](#)  
[52610-1075](#) [52610-1275](#) [52610-1934](#) [XF3M\(1\)-1415-1B-R100](#) [501864-3091-TR225](#) [0525594033](#) [086210010340800](#) [086222026001800](#)  
[52271-2869-CUT-TAPE](#) [62674-201121DLF](#) [62684-36210E9ALF](#) [52610-1675](#) [52746-1671-TR250](#) [10051922-2810EHLF](#) [6-520415-9](#)  
[BD021-09A-A1-0350-0200-0550-LD](#) [SFV6R-1STE9HLF](#) [XF3M-2915-1B-R100](#) [1658549-1](#) [62674-221121ALF](#) [46214008010800](#)  
[046298003000883](#) [151660622](#) [842-816-2630-035](#) [AYF530665TA](#) [AYF351525](#) [046296011930846+](#) [AYF352325A](#) [046254020000800+](#)  
[FH19C-13S-0.5SH\(99\)](#) [FH39J-51S-0.3SHW\(99\)](#) [AYF355125A](#) [AYF530365TA](#) [FH29B-44S-0.2SHW\(99\)](#) [SFW5R-2STAE9LF](#) [AYF351125A](#)  
[AYF350725A](#) [62684-502100AHLF](#) [FH39-61S-0.3SHW\(99\)](#) [AYF414035A](#) [10064555-172520HLF](#) [AYF212335A](#) [504754-2500](#)