

1

2

3

4

5

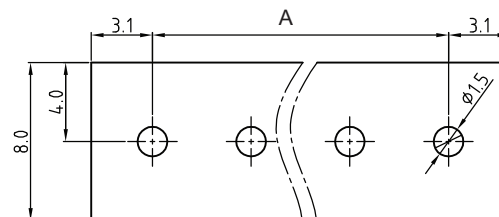

PCB LAYOUT - COMPONENT VIEW

## TECHNICAL CHARACTERISTICS

MATERIAL  
 INSULATOR: PA 66  
 FLAMMABILITY RATING: UL94-V0  
 COLOR: GREEN  
 METAL HOUSING: BRASS (CuZn)  
 TERMINAL SCREW: STEEL ZINC PLATING "+/-" SLOT TYPE  
 WIRE GUARD: STAINLESS STEEL  
 SURFACE OF SOLDER TAIL PLATING: TIN

ENVIRONMENTAL  
 OPERATING TEMPERATURE: -40 UP TO 105°C  
 COMPLIANCE: LEAD FREE AND ROHS

ELECTRICAL  
 CURRENT RATING: 15 A  
 WORKING VOLTAGE: 250 VAC  
 WITHSTANDING VOLTAGE: 2.5 KV  
 CONTACT RESISTANCE: 20 mOhm MAX

STANDARD  
 CERTIFIED E315414

MECHANICAL  
 SOLID WIRE: 24-14 AWG / 0.205-2.08 MM<sup>2</sup>  
 STRANDED WIRE: 24-14 AWG / 0.205-2.08 MM<sup>2</sup>  
 TORQUE: 2.6 Lb.In / 0.3 Nm

WIRE RANGE: WIRE STRIPE LENGTH: 5-6 MM  
 SCREW: M2.5  
 PITCH: 5.0 MM

SOLDERING  
 JEDEC LEAD FREE WAVE SOLDERING

PACKAGING  
 BOX

DIMENSION  
 A = (NB. PINS - 1) x PITCH  
 B = NB. PINS x PITCH

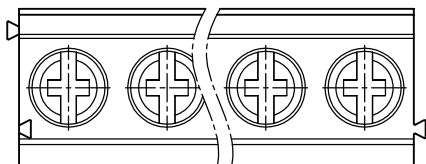
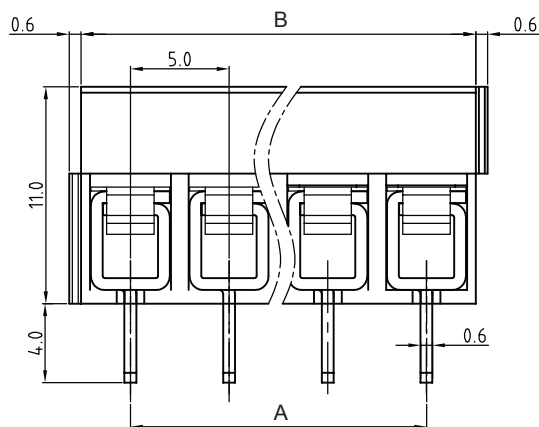
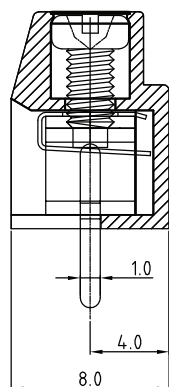

RoHS Compliant

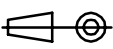
G				PROJECTION: 
F	07-MAY-17	DRAWING	AK	
E	25-FEB-16	UPDATE	AK	
D	06-SEP-09	PACKAGING	JC	
C	12-OCT-09	STANDARD	JP	
B	30-OCT-08	CHARACTERISTICS	JP	APPROVAL: FBr
A	30-OCT-07	PDF	EC	
REV	DATE	FILE	BY	

GENERAL TOLERANCE .X = $\pm 0.30$ .XX = $\pm 0.20$
UNIT: MM
SCALE:
SHEET: 1/3
DRAW: MARVIN



DESCRIPTION: SERIE 111 - 5.0MM HORIZONTAL ENTRY MODULAR  
 WITH PRESSURE CLAMP - WR-TBL

WERI PART NO: 691 111 710 0xx

SIZE

**A4**

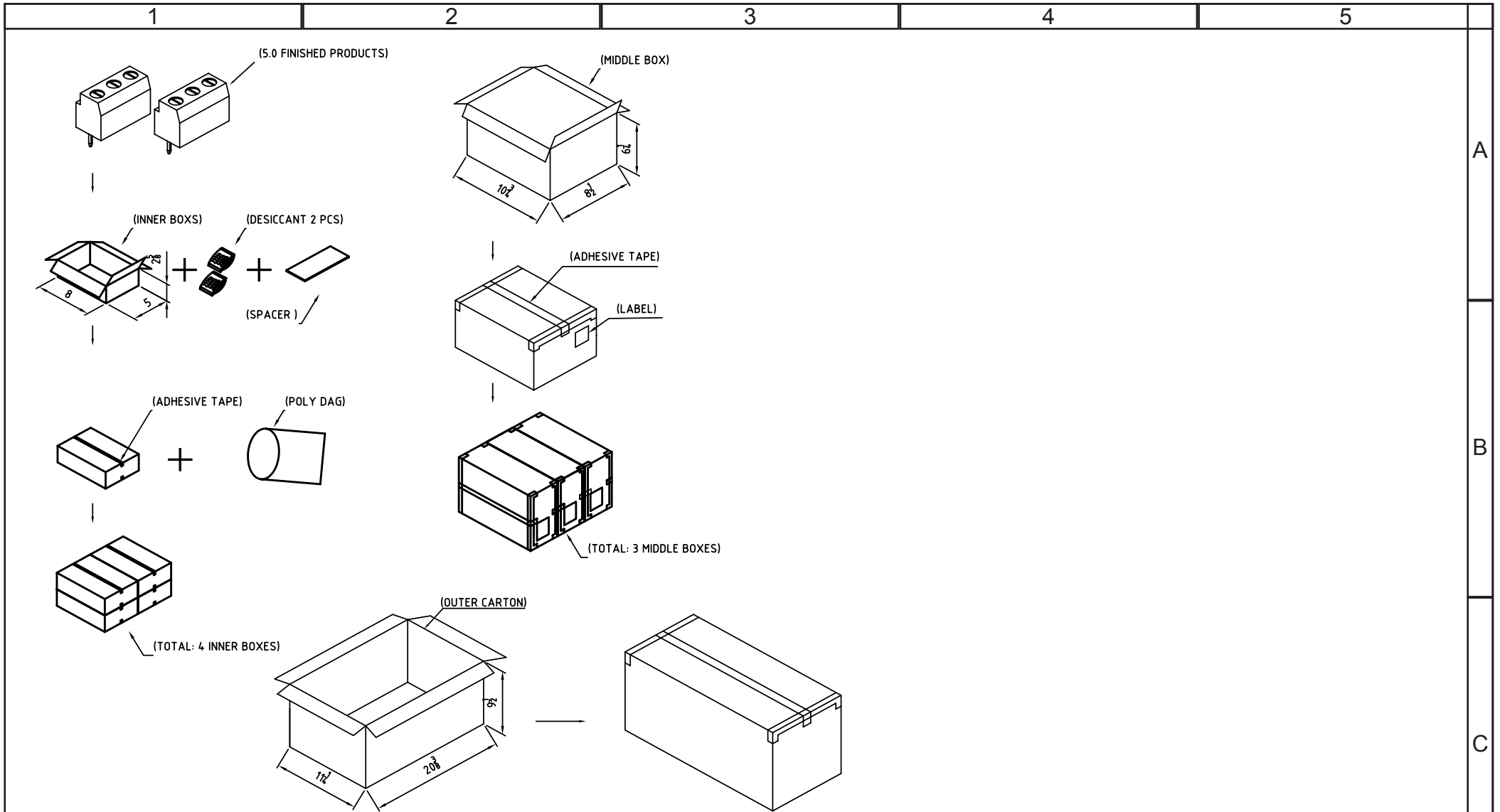

RoHS Compliant			
G			
F			
E			
D			
C			
B			
A			
REV	DATE	FILE	BY

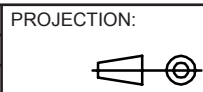

GENERAL TOLERANCE

.X = +/- 0.2

.XX = +/- 0.15

APPROVAL: FBr

UNIT: MM

SCALE:

SHEET: 2/3

DRAW: PEARL



DESCRIPTION: SERIE 111 - 5.0MM HORIZONTAL ENTRY MODULAR WITH PRESSURE CLAMP - WR-TBL

WERI PART NO: 691 111 710 0xx

SIZE

**A4**

1

2

3

4

5

## Cautions and Warnings:

This electronic component is designed and developed with the intention for use in general electronics equipments.

Before incorporating the components into any equipments in the field such as aerospace, aviation, nuclear control, submarine, transportation, (automotive control, train control, ship control), transportation signal, disaster prevention, medical, public information network etc. where higher safety and reliability are especially required or if there is possibility of direct damage or injury to human body, Würth Elektronik must be asked for a written approval.

In addition, even electronic component in general electronic equipments, when used in electrical circuits that require high safety, reliability functions or performance, the sufficient reliability evaluation-check for the safety must be performed before by the user before usage.

A

B

C

RoHS Compliant

G				PROJECTION: 	GENERAL TOLERANCE .X = +/- 0.2 .XX = +/- 0.15		
F							
E							
D							
C				APPROVAL: JC	UNIT: MM	DESCRIPTION: DISCLAIMER	SIZE <b>A4</b>
B					SCALE:		
A	10-SEP-14	PDF	QL		SHEET: 3/3	WERI PART NO: DISCLAIMER	
REV	DATE	FILE	BY		DRAW: QL		

D

## X-ON Electronics

Largest Supplier of Electrical and Electronic Components

*Click to view similar products for [Pluggable Terminal Blocks](#) category:*

*Click to view products by [Wurth](#) manufacturer:*

Other Similar products are found below :

[57.510.0053](#) [MC 1.5/ 6-ST-3.5 GY AU](#) [ET02015000J0G](#) [734-104](#) [734-302](#) [8-141-P](#) [8426620000](#) [860505](#) [860516](#) [860810](#) [GBPACX-12](#)  
[93.731.4953.0](#) [PV05-5,08-K](#) [PVP02-5,00](#) [PVP03-3,50](#) [PVP04-3,50](#) [PVS02-5,00](#) [1-1986160-3](#) [1377680000](#) [1531000000](#) [1546228-5](#)  
[ELFH16150](#) [ELFP03110](#) [ELFP10210](#) [ELFT06250](#) [ELVP03100](#) [1700101](#) [1700410](#) [1700425](#) [1702246](#) [1705229](#) [1710175](#) [1714537](#) [1717806](#)  
[1719600](#) [1728941](#) [1734692](#) [1734795](#) [1736036](#) [1740194](#) [1740291](#) [1740628](#) [1740990](#) [1746952](#) [1750207](#) [1752441](#) [1752865](#) [1754115](#)  
[1754144](#) [1756913](#)