

1

2

3

4

5

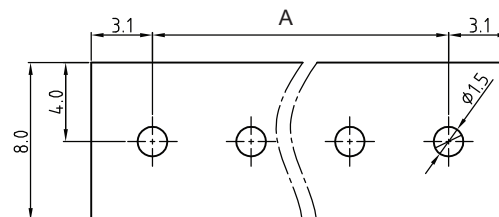

PCB LAYOUT - COMPONENT VIEW

TECHNICAL CHARACTERISTICS

MATERIAL
 INSULATOR: PA 66
 FLAMMABILITY RATING: UL94-V0
 COLOR: GREEN
 METAL HOUSING: BRASS (CuZn)
 TERMINAL SCREW: STEEL ZINC PLATING "+/-" SLOT TYPE
 WIRE GUARD: STAINLESS STEEL
 SURFACE OF SOLDER TAIL PLATING: TIN

ENVIRONMENTAL
 OPERATING TEMPERATURE: -40 UP TO 105°C
 COMPLIANCE: LEAD FREE AND ROHS

ELECTRICAL
 CURRENT RATING: 15 A
 WORKING VOLTAGE: 250 VAC
 WITHSTANDING VOLTAGE: 2.5 KV
 CONTACT RESISTANCE: 20 mOhm MAX

STANDARD
 CERTIFIED E315414

MECHANICAL
 SOLID WIRE: 24-14 AWG / 0.205-2.08 MM²
 STRANDED WIRE: 24-14 AWG / 0.205-2.08 MM²
 TORQUE: 2.6 Lb.In / 0.3 Nm

WIRE RANGE: WIRE STRIPE LENGTH: 5-6 MM
 SCREW: M2.5
 PITCH: 5.0 MM



SOLDERING
 JEDEC LEAD FREE WAVE SOLDERING

PACKAGING
 BOX

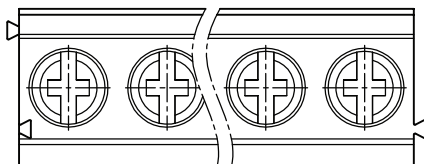
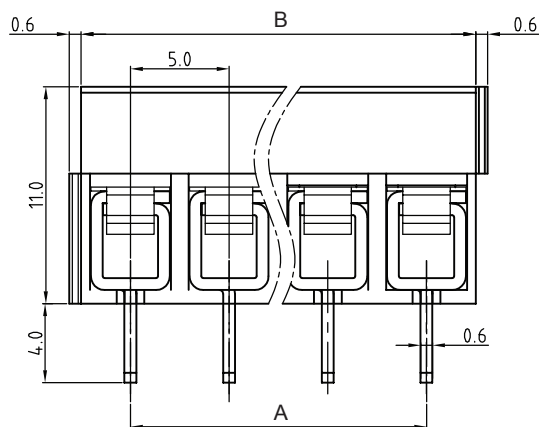
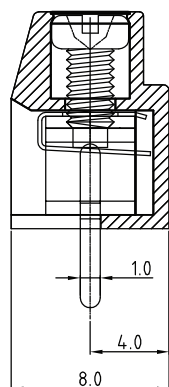
DIMENSION
 A = (NB. PINS - 1) x PITCH
 B = NB. PINS x PITCH

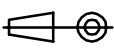

RoHS Compliant

G				PROJECTION: 	GENERAL TOLERANCE .X = +/- 0.30 .XX = +/- 0.20	 WÜRTH ELEKTRONIK	
F	07-MAY-17	DRAWING	AK				
E	25-FEB-16	UPDATE	AK				
D	06-SEP-09	PACKAGING	JC				
C	12-OCT-09	STANDARD	JP				
B	30-OCT-08	CHARACTERISTICS	JP	APPROVAL: FBr	UNIT: MM	DESCRIPTION: SERIE 111 - 5.0MM HORIZONTAL ENTRY MODULAR WITH PRESSURE CLAMP - WR-TBL	
A	30-OCT-07	PDF	EC		SCALE:		
REV	DATE	FILE	BY		SHEET: 1/3		WERI PART NO: 691 111 710 0xx
					DRAW: MARVIN		SIZE A4

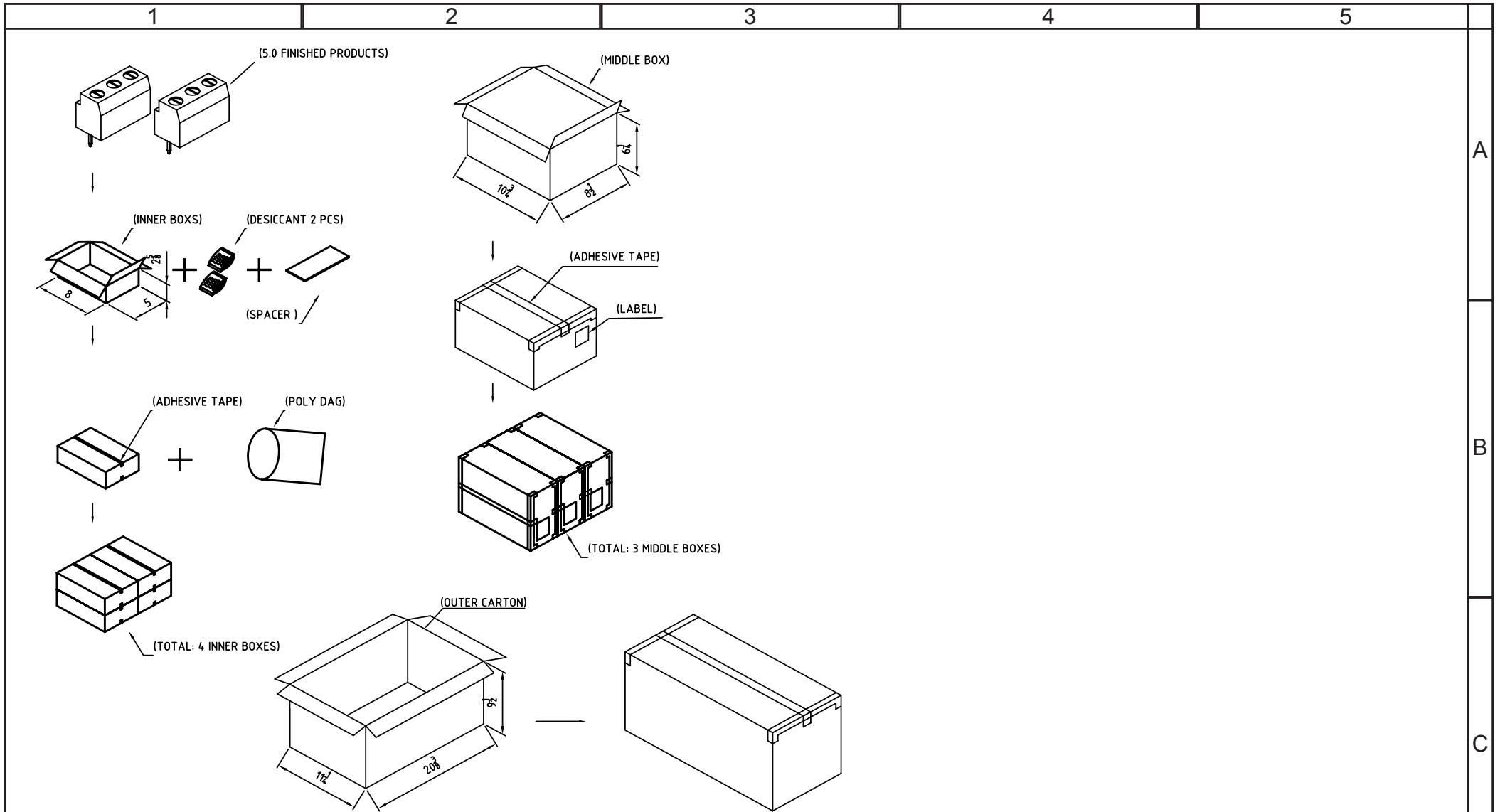

RoHS Compliant			
G			
F			
E			
D			
C			
B			
A			
REV	DATE	FILE	BY

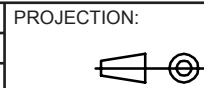

GENERAL TOLERANCE
 .X = ± 0.2
 .XX = ± 0.15



APPROVAL: FBr

UNIT: MM
 SCALE:
 SHEET: 2/3
 DRAW: PEARL

DESCRIPTION: SERIE 111 - 5.0MM HORIZONTAL ENTRY MODULAR WITH PRESSURE CLAMP - WR-TBL

WERI PART NO: 691 111 710 0xx

SIZE
A4

1

2

3

4

5

Cautions and Warnings:

This electronic component is designed and developed with the intention for use in general electronics equipments.

Before incorporating the components into any equipments in the field such as aerospace, aviation, nuclear control, submarine, transportation, (automotive control, train control, ship control), transportation signal, disaster prevention, medical, public information network etc. where higher safety and reliability are especially required or if there is possibility of direct damage or injury to human body, Würth Elektronik must be asked for a written approval.

In addition, even electronic component in general electronic equipments, when used in electrical circuits that require high safety, reliability functions or performance, the sufficient reliability evaluation-check for the safety must be performed before by the user before usage.

A

B

C

RoHS Compliant

G				PROJECTION: 	GENERAL TOLERANCE .X = +/- 0.2 .XX = +/- 0.15		
F							
E							
D							
C				APPROVAL: JC	UNIT: MM	DESCRIPTION: DISCLAIMER	SIZE A4
B					SCALE:		
A	10-SEP-14	PDF	QL		SHEET: 3/3	WERI PART NO: DISCLAIMER	
REV	DATE	FILE	BY		DRAW: QL		

D

X-ON Electronics

Largest Supplier of Electrical and Electronic Components

Click to view similar products for [Pluggable Terminal Blocks](#) category:

Click to view products by [Wurth](#) manufacturer:

Other Similar products are found below :

[57.510.0053](#) [MC 1.5/ 6-ST-3.5 GY AU](#) [ET02015000J0G](#) [734-104](#) [734-302](#) [8-141-P](#) [8426620000](#) [860505](#) [860516](#) [860810](#) [GBPACX-12](#)
[93.731.4953.0](#) [PV05-5,08-K](#) [PVP03-3,50](#) [PVP04-3,50](#) [PVS02-5,00](#) [1-1986160-3](#) [1377680000](#) [1531000000](#) [1546228-5](#) [ELFH16150](#)
[ELFP03110](#) [ELFP10210](#) [ELFT06250](#) [ELVP03100](#) [1700101](#) [1700410](#) [1700425](#) [1702246](#) [1705229](#) [1710175](#) [1714537](#) [1717806](#) [1719600](#)
[1728941](#) [1734692](#) [1734795](#) [1736036](#) [1740194](#) [1740628](#) [1740990](#) [1746952](#) [1750207](#) [1752441](#) [1752865](#) [1754115](#) [1754144](#) [1756913](#)
[1760051](#) [1760336](#)