

PCB LAYOUT - COMPONENT VIEW

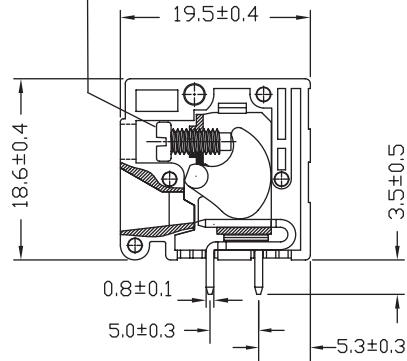
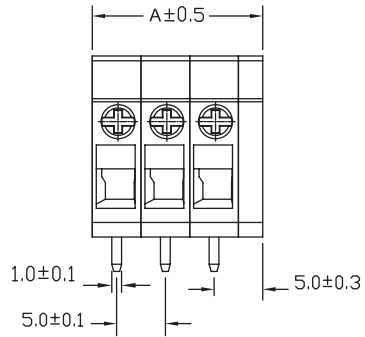

TECHNICAL CHARACTERISTICS

MATERIAL  
 INSULATOR: PA 66  
 FLAMABILITY RATING: UL94-V0  
 COLOR: GREEN  
 METAL HOUSING: STEEL ZINC PLATING  
 CONTACT PIN: BRASS (CuZn)  
 SURFACE OF SOLDER TAIL PLATING: TIN  
 TERMINAL SCREW: STEEL ZINC PLATING  
 TERMINAL SCREW SLOT TYPE: "+"  
 WIRE GUARD: STEEL

ENVIRONMENTAL  
 OPERATING TEMPERATURE: -40 UP TO 105°C  
 COMPLIANCE: LEAD FREE AND ROHS

ELECTRICAL  
 CURRENT RATING: 20A  
 WORKING VOLTAGE: 300VAC  
 WITHSTANDING VOLTAGE: 2.0KV  
 CONTACT RESISTANCE: 20 mOhm max

STANDARD  
 RoHS CERTIFIED E315414 / Model number 69112671

MECHANICAL  
 SOLID WIRE: 30-12 AWG / 0.05-3.3MM<sup>2</sup>  
 STRANDED WIRE: 30-12 AWG / 0.05-3.3MM<sup>2</sup>  
 TORQUE: 4.0Lb-In / 0.45Nm

WIRE STRIPE LENGTH: 9MM  
 PITCH: 5.00MM

PACKAGING: BOX

SERIE 126B

Pitch : 5.00mm (0.197inch)					
Poles	A(mm)	A(inch)	Poles	A(mm)	A(inch)
2	12.50	0.492	15	77.50	3.051
3	17.50	0.689	16	82.50	3.248
4	22.50	0.886	17	87.50	3.445
5	27.50	1.083	18	92.50	3.642
6	32.50	1.280	19	97.50	3.839
7	37.50	1.476	20	102.50	4.035
8	42.50	1.673	21	107.50	4.232
9	47.50	1.870	22	112.50	4.429
10	52.50	2.067	23	117.50	4.626
11	57.50	2.264	24	122.50	4.823
12	62.50	2.461			
13	67.50	2.657			
14	72.50	2.854			

RoHS Compliant

G			
F			
E			
D			
C			
B	17-JUL-14	DRAWING	AS
A	20-JUN-12	PDF	GG
REV	DATE	FILE	BY

PROJECTION:

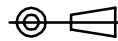

APPROVAL: RJ

GENERAL TOLERANCE

.X = +/- 0.2  
 .XX = +/- 0.15



UNIT: MM

SCALE:

SHEET: 1/1

DRAW: MARVIN

DESCRIPTION: SERIE 126B - 5,0mm Horizontal Entry with Stamping Clamp

WERI PART NO: 691 126 710 0xx B

SIZE

**A4**

## X-ON Electronics

Largest Supplier of Electrical and Electronic Components

*Click to view similar products for [Pluggable Terminal Blocks](#) category:*

*Click to view products by [Wurth](#) manufacturer:*

Other Similar products are found below :

[57.510.0053](#) [MC 1.5/ 6-ST-3.5 GY AU](#) [ET02015000J0G](#) [734-104](#) [734-302](#) [8-141-P](#) [8426620000](#) [860505](#) [860516](#) [860810](#) [GBPACX-12](#)  
[93.731.4953.0](#) [PV05-5,08-K](#) [PVP03-3,50](#) [PVP04-3,50](#) [PVS02-5,00](#) [1-1986160-3](#) [1377680000](#) [1531000000](#) [1546228-5](#) [ELFH16150](#)  
[ELFP03110](#) [ELFP10210](#) [ELFT06250](#) [ELVP03100](#) [1700101](#) [1700410](#) [1700425](#) [1702246](#) [1705229](#) [1710175](#) [1714537](#) [1717806](#) [1719600](#)  
[1728941](#) [1734692](#) [1734795](#) [1736036](#) [1740194](#) [1740628](#) [1740990](#) [1746952](#) [1750207](#) [1752441](#) [1752865](#) [1754115](#) [1754144](#) [1756913](#)  
[1760051](#) [1760336](#)