

1

2

3

4

5

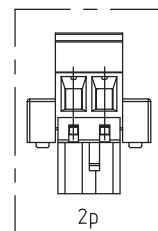
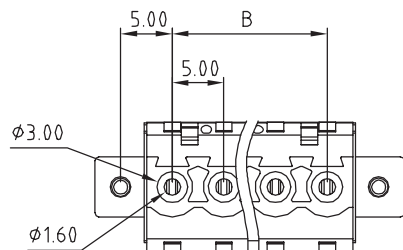

#### TECHNICAL CHARACTERISTICS

MATERIAL  
 INSULATOR: PA 66  
 FLAMMABILITY RATING: UL94-V0  
 COLOR: GREEN  
 METAL HOUSING: BRASS (CuZn)  
 TERMINAL SCREW: STEEL ZINC PLATING  
 TERMINAL SCREW SLOT TYPE: "I"  
 CONTACT: BRASS  
 WIRE GUARD: PhBz TIN PLATED  
 FLANGES SCREW: STEEL M2.5

ENVIRONMENTAL  
 OPERATING TEMPERATURE: -40 UP TO 105°C  
 COMPLIANCE: LEAD FREE AND ROHS

ELECTRICAL	cULus	VDE
CURRENT RATING:	15 A	17 A
WORKING VOLTAGE:	300 VAC	300 VAC
WITHSTANDING VOLTAGE:	1.6 KV	2.5 KV
CONTACT RESISTANCE:	20 mOhm max	

STANDARD  
 CERTIFIED E315414  
 CERTIFIED 40023402

MECHANICAL	
SOLID WIRE:	24-12 AWG / 0.2-3.0 MM <sup>2</sup>
STRANDED WIRE:	24-12 AWG / 0.2-3.0 MM <sup>2</sup>
TORQUE:	3.5 Lb-In / 0.4 Nm



WIRE STRIPE LENGTH: 6-7 MM  
 SCREW: M3.0  
 PITCH: 5.00 MM

PACKAGING  
 BOX

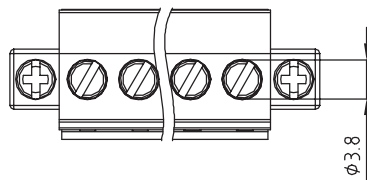
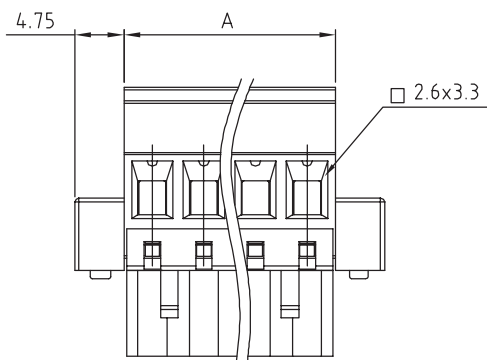
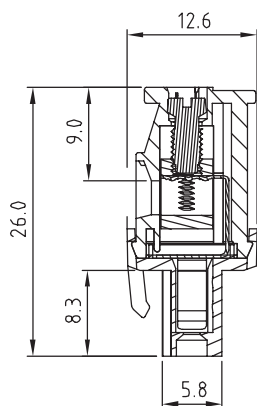
DIMENSION  
 A = (NB. PINS - 1) x PITCH  
 B = NB. PINS x PITCH

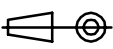

RoHS Compliant

G	F	E	D	C	B	A	REV	DATE	FILE	BY	PROJECTION:	GENERAL TOLERANCE	UNIT: MM	SCALE:	SHEET: 1/2	DRAW: MARVIN	DESCRIPTION: SERIE 3407 - 5.00MM HORIZONTAL CABLE ENTRY PLUG WITH FLANGES & HOOK ON WIRE SIDE - WR-TBL	WERI PART NO: 691 340 700 0xx	SIZE
			20-APR-16	21-OCT-09	13-OCT-09	04-NOV-08						.X = +/- 0.2 .XX = +/- 0.15							A4
			DRAWING	SCREW	STANDARD	PDF				APPROVAL: FBr									

1

2

3

4

5

## Cautions and Warnings:

This electronic component is designed and developed with the intention for use in general electronics equipments.

Before incorporating the components into any equipments in the field such as aerospace, aviation, nuclear control, submarine, transportation, (automotive control, train control, ship control), transportation signal, disaster prevention, medical, public information network etc. where higher safety and reliability are especially required or if there is possibility of direct damage or injury to human body, Würth Elektronik must be asked for a written approval.

In addition, even electronic component in general electronic equipments, when used in electrical circuits that require high safety, reliability functions or performance, the sufficient reliability evaluation-check for the safety must be performed before by the user before usage.

A

B

C

RoHS Compliant

G				PROJECTION: 	GENERAL TOLERANCE .X = +/- 0.2 .XX = +/- 0.15		
F							
E							
D							
C				APPROVAL: JC	UNIT: MM	DESCRIPTION: DISCLAIMER	SIZE <b>A4</b>
B					SCALE:		
A	10-SEP-14	PDF	QL		SHEET: 2/2	WERI PART NO: DISCLAIMER	
REV	DATE	FILE	BY		DRAW: QL		

D

## X-ON Electronics

Largest Supplier of Electrical and Electronic Components

*Click to view similar products for [Pluggable Terminal Blocks](#) category:*

*Click to view products by [Wurth](#) manufacturer:*

Other Similar products are found below :

[57.510.0053](#) [MC 1.5/ 6-ST-3.5 GY AU](#) [734-104](#) [734-302](#) [8-141-P](#) [8426620000](#) [860505](#) [860516](#) [860810](#) [GBPACX-12](#) [93.731.4953.0](#) [PV05-5,08-K](#) [PVP02-5,00](#) [PVP03-3,50](#) [PVP04-3,50](#) [PVS02-5,00](#) [1-1986160-3](#) [1377680000](#) [1531000000](#) [1546228-5](#) [ELFH16150](#) [ELFP03110](#) [ELFP10210](#) [ELFT06250](#) [ELVP03100](#) [1700101](#) [1700410](#) [1700425](#) [1702246](#) [1705229](#) [1710175](#) [1714537](#) [1717806](#) [1719600](#) [1728941](#) [1734692](#) [1734795](#) [1736036](#) [1740194](#) [1740291](#) [1740628](#) [1740990](#) [1746952](#) [1750207](#) [1752441](#) [1752865](#) [1754115](#) [1754144](#) [1756913](#) [1760051](#)