

1

2

3

4

5

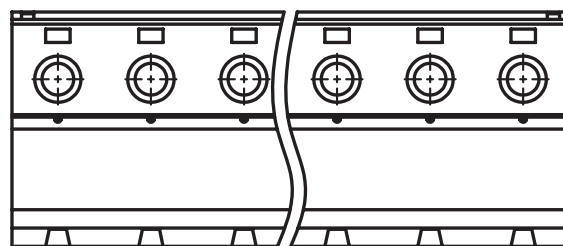
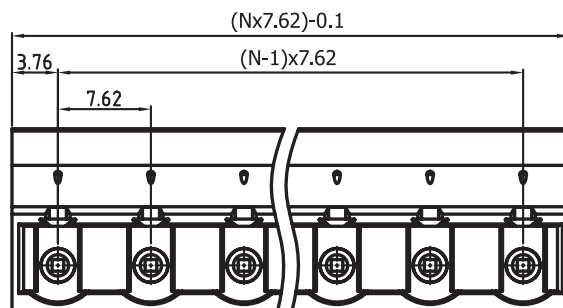
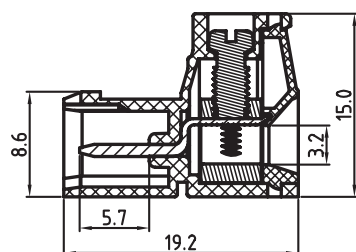

#### TECHNICAL CHARACTERISTICS

MATERIAL  
 INSULATOR: PA 66  
 FLAMABILITY RATING: UL94-V0  
 COLOR: GREEN  
 METAL HOUSING: BRASS (CuZn)  
 TERMINAL SCREW: STEEL ZINC PLATING  
 TERMINAL SCREW SLOT TYPE: "-"  
 CONTACT: BRASS  
 WIRE GUARD: PhBz TIN PLATED

ENVIRONMENTAL  
 OPERATING TEMPERATURE: -40 UP TO 105°C  
 COMPLIANCE: LEAD FREE AND ROHS

ELECTRICAL  
 CURRENT RATING: 20A  
 WORKING VOLTAGE: 300VAC  
 WITHSTANDING VOLTAGE: 1.6KV  
 CONTACT RESISTANCE: 20 mOhm max



STANDARD  
 CERTIFIED E315414

MECHANICAL  
 SOLID WIRE: 24-12 AWG / 0.205-3.31 MM<sup>2</sup>  
 STRANDED WIRE: 24-12 AWG / 0.205-3.31 MM<sup>2</sup>  
 TORQUE: 5.0 Lb-In / 0.56 Nm

WIRE STRIPE LENGTH: 7-8 MM  
 SCREW: M3.0  
 PITCH: 7.62 MM

PACKAGING  
 BOX

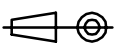
RoHS Compliant

G				PROJECTION: 	GENERAL TOLERANCE .X = +/- 0.2 .XX = +/- 0.15	 <b>WÜRTH ELEKTRONIK</b>	DESCRIPTION: SERIE 3484 - 7.62MM REVERSED GENDER VERTCAL CABLE ENTRY PLUG - WR-TBL	SIZE <b>A4</b>
F								
E								
D								
C	05-OCT-10	CURRENT RATING	JC	APPROVAL: RJ	UNIT: MM	WERI PART NO: 691 348 400 0xx		
B	16-OCT-09	STANDARD	JP		SCALE:			
A	05-NOV-08	PDF	JP		SHEET: 1/2			
REV	DATE	FILE	BY		DRAW: MARVIN			

1

2

3

4

5

## Cautions and Warnings:

This electronic component is designed and developed with the intention for use in general electronics equipments.

Before incorporating the components into any equipments in the field such as aerospace, aviation, nuclear control, submarine, transportation, (automotive control, train control, ship control), transportation signal, disaster prevention, medical, public information network etc. where higher safety and reliability are especially required or if there is possibility of direct damage or injury to human body, Würth Elektronik must be asked for a written approval.



In addition, even electronic component in general electronic equipments, when used in electrical circuits that require high safety, reliability functions or performance, the sufficient reliability evaluation-check for the safety must be performed before by the user before usage.

A

B

C

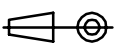
RoHS Compliant

G				PROJECTION: 	GENERAL TOLERANCE .X = +/- 0.2 .XX = +/- 0.15	 <b>WÜRTH ELEKTRONIK</b>	
F							
E							
D							
C				APPROVAL: JC	UNIT: MM	DESCRIPTION: DISCLAIMER	SIZE <b>A4</b>
B					SCALE:		
A	10-SEP-14	PDF	QL		SHEET: 2/2	WERI PART NO: DISCLAIMER	
REV	DATE	FILE	BY		DRAW: QL		

D

## X-ON Electronics

Largest Supplier of Electrical and Electronic Components

*Click to view similar products for [Pluggable Terminal Blocks](#) category:*

*Click to view products by [Wurth](#) manufacturer:*

Other Similar products are found below :

[57.510.0053](#) [MC 1.5/ 6-ST-3.5 GY AU](#) [734-104](#) [734-302](#) [8-141-P](#) [8426620000](#) [860505](#) [860516](#) [860810](#) [GBPACX-12](#) [93.731.4953.0](#) [PV05-5,08-K](#) [PVP02-5,00](#) [PVP03-3,50](#) [PVP04-3,50](#) [PVS02-5,00](#) [1-1986160-3](#) [1377680000](#) [1531000000](#) [1546228-5](#) [ELFH16150](#) [ELFP03110](#) [ELFP10210](#) [ELFT06250](#) [ELVP03100](#) [1700101](#) [1700410](#) [1700425](#) [1702246](#) [1705229](#) [1710175](#) [1714537](#) [1717806](#) [1719600](#) [1728941](#) [1734692](#) [1734795](#) [1736036](#) [1740194](#) [1740291](#) [1740628](#) [1740990](#) [1746952](#) [1750207](#) [1752441](#) [1752865](#) [1754115](#) [1754144](#) [1756913](#) [1760051](#)