

1

2

3

4

5

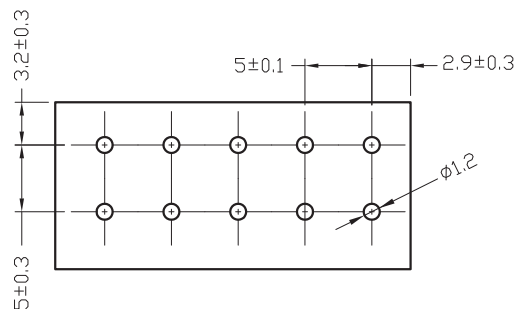

RECOMMENDED PCB LAYOUT - COMPONENT VIEW

TECHNICAL CHARACTERISTICS

MATERIAL
 INSULATOR: PA 66
 FLAMABILITY RATING: UL94-V0
 COLOR: GRAY/WHITE
 METAL HOUSING: BRASS (CuZn)
 WIRE GUARD: STAINLESS STEEL
 SOLDER TAIL PLATING: TIN

ENVIRONMENTAL
 OPERATING TEMPERATURE: -40 UP TO 115°C
 COMPLIANCE: LEAD FREE AND ROHS

ELECTRICAL
 CURRENT RATING: 10 A
 WORKING VOLTAGE: 300 VAC
 WITHSTANDING VOLTAGE: 2.0 KV
 CONTACT RESISTANCE: 20 mOhm MAX

STANDARD
 cULus CERTIFIED E315414

MECHANICAL
 SOLID WIRE: 14-20 AWG / 0.5-2.1 MM²
 STRANDED WIRE: 14-20 AWG / 0.5-2.1 MM²

WIRE STRIPE LENGTH: 9-10 MM
 PITCH: 5.0 MM



SOLDERING
 JEDEC LEAD FREE WAVE SOLDERING PROCESS

PACKAGING
 BOX

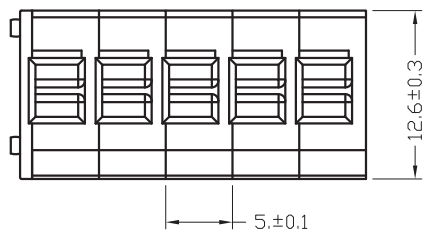
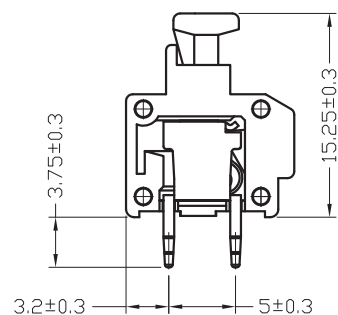
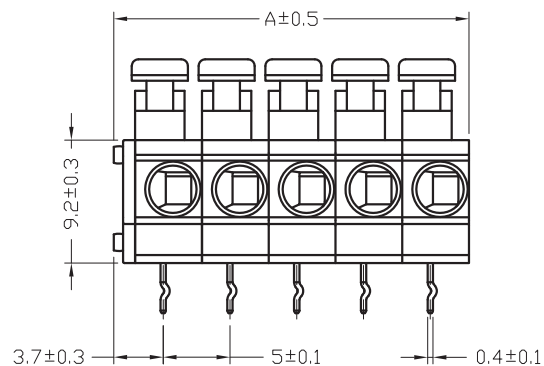
DIMENSION
 A = (NB. PIN x5) +1,6

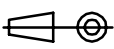

RoHS Compliant

G				PROJECTION: 	GENERAL TOLERANCE .X = +/- 0.2 .XX = +/- 0.15		
F							
E							
D							
C	11-SEP-17	REMOVE TABLE	AK	APPROVAL: FBr	UNIT: MM	DESCRIPTION: SERIE 411 B - 5.00MM SCREWLESS HORIZONTAL ENTRY 2.0MM ² WIRES WR-TBL	
B	29-JUL-13	DWG REVIEW	QL		SCALE:		
A	02-JUL-12	PDF	GG		SHEET: 1/2	WERI PART NO: 691 411 710 0xx B	SIZE A4
REV	DATE	FILE	BY		DRAW: MARVIN		

1

2

3

4

5

Cautions and Warnings:

This electronic component is designed and developed with the intention for use in general electronics equipments.

Before incorporating the components into any equipments in the field such as aerospace, aviation, nuclear control, submarine, transportation, (automotive control, train control, ship control), transportation signal, disaster prevention, medical, public information network etc. where higher safety and reliability are especially required or if there is possibility of direct damage or injury to human body, Würth Elektronik must be asked for a written approval.



In addition, even electronic component in general electronic equipments, when used in electrical circuits that require high safety, reliability functions or performance, the sufficient reliability evaluation-check for the safety must be performed before by the user before usage.

A

B

C

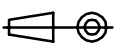
RoHS Compliant

G				PROJECTION: 	GENERAL TOLERANCE .X = \pm 0.2 .XX = \pm 0.15		
F							
E							
D							
C				APPROVAL: JC	UNIT: MM	DESCRIPTION: DISCLAIMER	SIZE A4
B					SCALE:		
A	10-SEP-14	PDF	QL		SHEET: 2/2	WERI PART NO: DISCLAIMER	
REV	DATE	FILE	BY		DRAW: QL		

D

X-ON Electronics

Largest Supplier of Electrical and Electronic Components

Click to view similar products for [Fixed Terminal Blocks](#) category:

Click to view products by [Wurth](#) manufacturer:

Other Similar products are found below :

[MBE-1512](#) [MBE-1520](#) [MBE-154](#) [MBE-156](#) [MBES-156](#) [MH-2512](#) [MHE-132](#) [MHE-163](#) [MI-254 \(35\)](#) [MI-272](#) [MPT-275](#) [ELM10110G](#)
[BA311TU](#) [BA411SU](#) [MV-253/NCNOC](#) [MV-254-D](#) [MV-255](#) [MV-493](#) [MVE-252](#) [MVE-253](#) [MVE-273](#) [MVEB-153](#) [1700096](#) [1705142](#)
[1712417](#) [1713088](#) [1745195](#) [1760594](#) [1-796689-8](#) [1-796692-6](#) [1800114](#) [20020314-C121B01LF](#) [20020316-G041B01LF](#) [KP03215000J0G](#)
[KP04215000J0G](#) [S451](#) [29.007](#) [29.116](#) [30.103](#) [30.106](#) [30.503](#) [30.608](#) [30.755](#) [30.853](#) [9872-0-00-15-00-00-33-0](#) [996750](#) [1706303](#) [1710052](#)
[1712418](#) [1733868](#)