

1

2

3

4

5

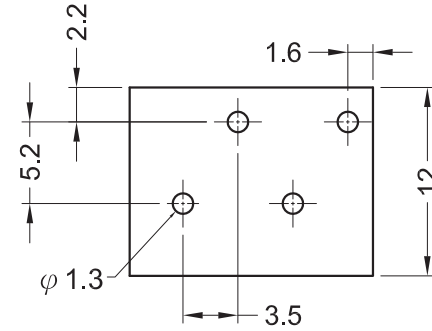

TECHNICAL CHARACTERISTICS

MATERIAL
 INSULATOR: PA 66
 FLAMMABILITY RATING: UL94-V0
 COLOR: GRAY
 METAL HOUSING: PhBz
 SOLDER TAIL PLATING: TIN

ENVIRONMENTAL
 OPERATING TEMPERATURE: -40°C UP TO 105°C
 COMPLIANCE: LEAD FREE AND ROHS

ELECTRICAL

CURRENT RATING:	cULus	VDE
WORKING VOLTAGE:	6 A	2 A
WITHSTANDING VOLTAGE:	300 VAC	250 VAC
CONTACT RESISTANCE:	1.6 KV	2.5 KV
	20 mΩ MAX	

STANDARD
 CERTIFIED E315414
 CERTIFIED 40036145

MECHANICAL
 SOLID WIRE: 20-14 AWG / 0.518-2.08 MM²
 STRANDED WIRE : 20-14 AWG / 0.518-2.08MM²

WIRE STRIPE LENGTH: 7.5-8.5 MM
 PITCH: 3.5 MM

SOLDERING
 JEDEC LEAD FREE WAVE SOLDERING PROCESS

PACKAGING
 BOX

DIMENSION
 A = (3.5 x NB PINS) + 1.5

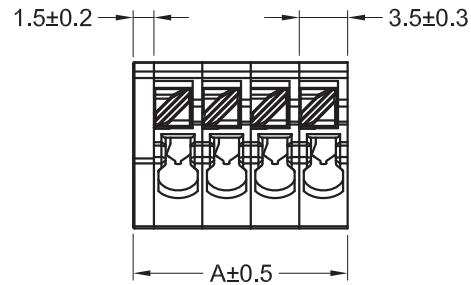
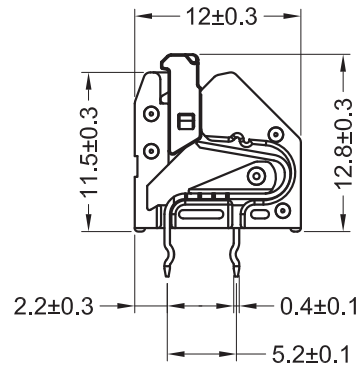
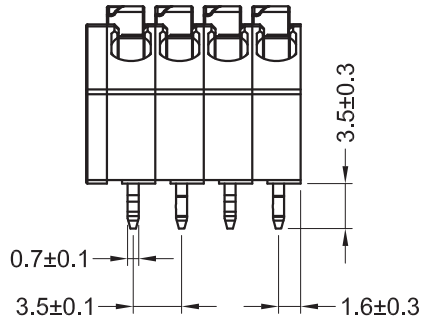

A

B

C

RoHS Compliant			
I	01-DEC-15	VDE CERTIFIED	AK
H	10-AUG-15	STRANDED WIRE	AK
REV	DATE	FILE	BY

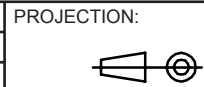

GENERAL TOLERANCE
 .X = +/- 0.2
 .XX = +/- 0.15



APPROVAL: FBr

UNIT: MM
 SCALE:
 SHEET: 1/2
 DRAW: AS

DESCRIPTION: SERIE 412 B - 3.5MM SCREWLESS 45° ENTRY GREY
 - WR-TBL
 WERI PART NO: 691 412 120 0xx B

SIZE
A4

D

1

2

3

4

5

Cautions and Warnings:

This electronic component is designed and developed with the intention for use in general electronics equipments.

Before incorporating the components into any equipments in the field such as aerospace, aviation, nuclear control, submarine, transportation, (automotive control, train control, ship control), transportation signal, disaster prevention, medical, public information network etc. where higher safety and reliability are especially required or if there is possibility of direct damage or injury to human body, Würth Elektronik must be asked for a written approval.



In addition, even electronic component in general electronic equipments, when used in electrical circuits that require high safety, reliability functions or performance, the sufficient reliability evaluation-check for the safety must be performed before by the user before usage.

A

B

C

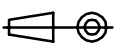
RoHS Compliant

G				PROJECTION: 	GENERAL TOLERANCE .X = +/- 0.2 .XX = +/- 0.15		
F							
E							
D							
C				APPROVAL: JC	UNIT: MM	DESCRIPTION: DISCLAIMER	SIZE A4
B					SCALE:		
A	10-SEP-14	PDF	QL		SHEET: 2/2	WERI PART NO: DISCLAIMER	
REV	DATE	FILE	BY		DRAW: QL		

D

X-ON Electronics

Largest Supplier of Electrical and Electronic Components

Click to view similar products for [Fixed Terminal Blocks](#) category:

Click to view products by [Wurth](#) manufacturer:

Other Similar products are found below :

[MBE-1512](#) [MBE-1520](#) [MBE-154](#) [MBE-156](#) [MBES-156](#) [MH-2512](#) [MHE-132](#) [MHE-163](#) [MI-254 \(35\)](#) [MI-272](#) [MPT-275](#) [ELM10110G](#)
[BA311TU](#) [BA411SU](#) [MV-253/NCNOC](#) [MV-254-D](#) [MV-255](#) [MV-493](#) [MVE-252](#) [MVE-253](#) [MVE-273](#) [MVEB-153](#) [1700096](#) [1705142](#)
[1712417](#) [1713088](#) [1745195](#) [1760594](#) [1-796689-8](#) [1-796692-6](#) [1800114](#) [20020314-C121B01LF](#) [20020316-G041B01LF](#) [KP03215000J0G](#)
[KP04215000J0G](#) [S451](#) [29.007](#) [29.116](#) [30.103](#) [30.106](#) [30.503](#) [30.608](#) [30.755](#) [30.853](#) [9872-0-00-15-00-00-33-0](#) [996750](#) [1706303](#) [1710052](#)
[1712418](#) [1733868](#)