

1

2

3

4

5

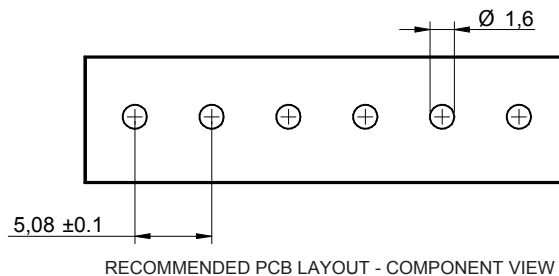

### CHARACTERISTICS

#### MATERIAL

Insulator material : LCP  
 Flammability rating : UL94-V0  
 Colour : Black  
 Contact pin : Brass (CuZn)  
 Surface of solder tail plating : Tin Plated

#### ENVIRONMENTAL

Operating temperature : -40°C up to 105°C  
 Compliance : Lead free and RoHS

#### SOLDERING

Solder temperature : Reflow process as per JEDEC J-020D-STD

#### ELECTRICAL

Current rating : 10A  
 Working voltage : 300 Vac  
 Dielectric withstanding voltage : 4 kVac/min  
 Contact resistance : 20 mΩ max

#### STANDARD

 Certified : E315414 / Model number 7015

#### MECHANICAL

Pitch : 5.08mm

#### PACKAGING

Tape & Reel with cap

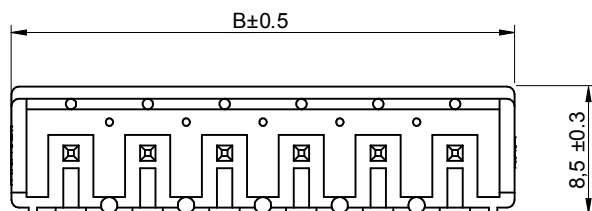

Poles	A	B
2	5.08	12.96
3	10.16	18.04
4	15.24	23.12
5	20.32	28.2
6	25.4	33.28
7	30.48	38.36
8	35.56	43.44
9	40.64	48.52
10	45.72	53.6
11	50.8	58.68
12	55.88	63.76

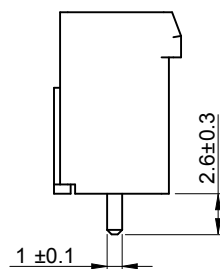
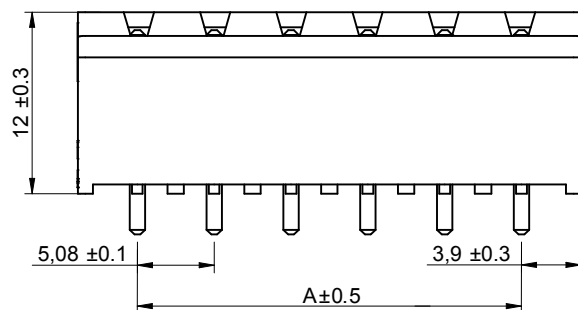

RoHS Compliant

G			
F			
E			
D			
C	29-JUL-13	DWG REVIEW	QL
B	19-DEC-11	6917015100xx	QL
A	15-SEP-11	PDF	QL
REV	DATE	FILE	BY

PROJECTION:

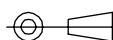

GENERAL TOLERANCE

.X =  $\pm 0.2$

.XX =  $\pm 0.15$



APPROVAL: RJ

UNIT: MM

SCALE: 2/1

SHEET: 1/2

DRAW: QUENTIN

DESCRIPTION: SERIE 7015B - 5.08MM CLOSED VERTICAL PCB HEADER - THR TYPE

WERI PART NO: 691 701 510 0xx B

SIZE

**A4**

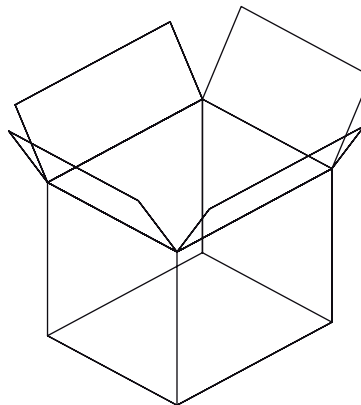
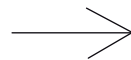
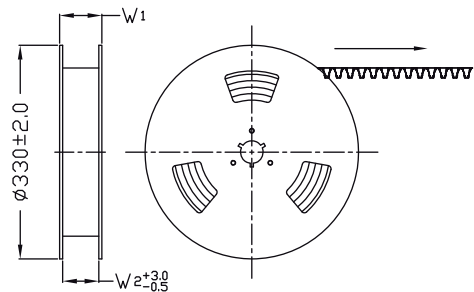

1. 10 sprocket hole pitch cumulative tolerance  $\pm 0.20$
2. Carrier camber is within 1 mm in 250 mm.
3. Material : Black Conductive Polystyrene Alloy.  
Transparent anti-static PET
4. All dimensions meet EIA-481-C requirements.
5. Thickness :  $0.50 \pm 0.05$  mm.
6. Component load per 13" reel : 150 pcs.

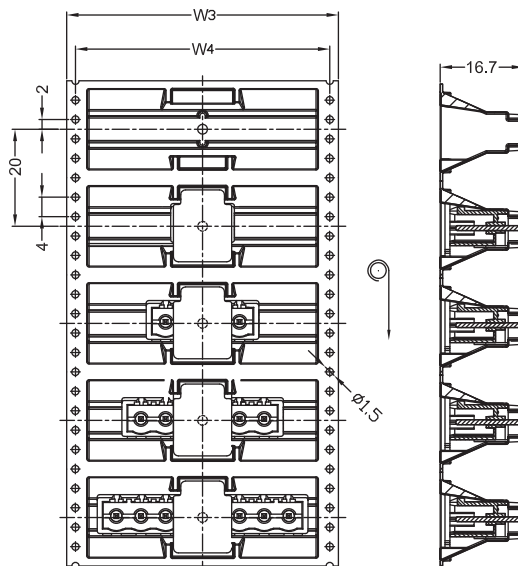
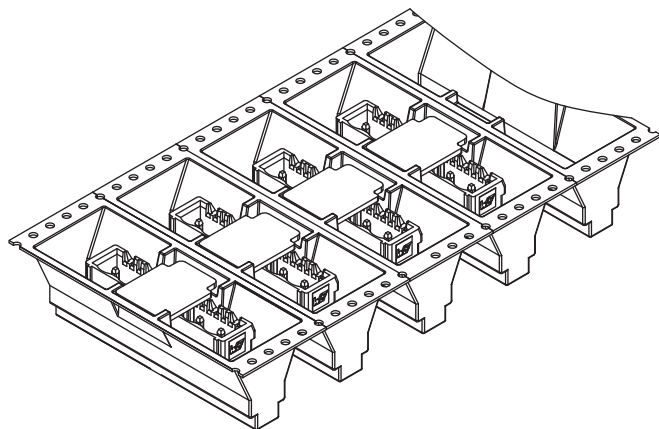
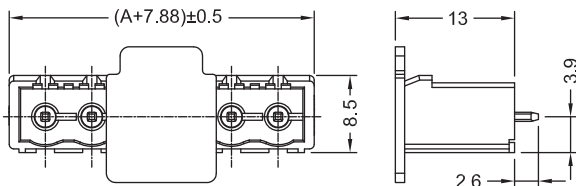

Poles	A	Dimension				Packing (Reel/cotton)	Carton dimensions (cm)	Quantity / Carton
		W1(mm)	W2(mm)	W3(mm)	W4(mm)			
2	5.08	36.4	32	32	28.4	10	33.5 x 33.5 x 40	1500
3	10.16	36.4	32	32	28.4	10	33.5 x 33.5 x 40	1500
4	15.24	60.4	56	56	52.5	6	33.5 x 33.5 x 40	900
5	20.32	60.4	56	56	52.5	6	33.5 x 33.5 x 40	900
6	25.40	60.4	56	56	52.5	6	33.5 x 33.5 x 40	900
7	30.48	60.4	56	56	52.5	6	33.5 x 33.5 x 40	900
8	35.56	60.4	56	56	52.5	6	33.5 x 33.5 x 40	900
9	40.64	92.4	88	88	84.4	4	33.5 x 33.5 x 40	600
10	45.72	92.4	88	88	84.4	4	33.5 x 33.5 x 40	600
11	50.80	92.4	88	88	84.4	4	33.5 x 33.5 x 40	600
12	55.88	92.4	88	88	84.4	4	33.5 x 33.5 x 40	600

RoHS Compliant

G			
F			
E			
D			
C			
B			
A			
REV	DATE	FILE	BY

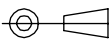
PROJECTION:  
  
 APPROVAL: RJ

GENERAL TOLERANCE  
 .X =  $\pm 0.2$   
 .XX =  $\pm 0.15$   
 UNIT: MM  
 SCALE:  
 SHEET: 2/2  
 DRAW: QUENTIN



DESCRIPTION: SERIE 7015B - 5.08MM CLOSED VERTICAL PCB HEADER - THR TYPE  
 WERI PART NO: 691 701 510 0xx B

SIZE  
**A4**

## X-ON Electronics

Largest Supplier of Electrical and Electronic Components

*Click to view similar products for [Pluggable Terminal Blocks](#) category:*

*Click to view products by [Wurth](#) manufacturer:*

Other Similar products are found below :

[57.510.0053](#) [MC 1.5/ 6-ST-3.5 GY AU](#) [ET02015000J0G](#) [734-104](#) [734-302](#) [8-141-P](#) [8426620000](#) [860505](#) [860516](#) [860810](#) [GBPACX-12](#)  
[PV05-5,08-K](#) [PVP02-5,00](#) [PVP03-3,50](#) [PVP04-3,50](#) [PVS02-5,00](#) [1-1986160-3](#) [1377680000](#) [1531000000](#) [1546228-5](#) [ELFH16150](#)  
[ELFP03110](#) [ELFP10210](#) [ELFT06250](#) [ELVP03100](#) [1700101](#) [1700410](#) [1700425](#) [1702246](#) [1705229](#) [1710175](#) [1714537](#) [1717806](#) [1719600](#)  
[1728941](#) [1734692](#) [1734795](#) [1736036](#) [1740194](#) [1740628](#) [1740990](#) [1746952](#) [1750207](#) [1752441](#) [1752865](#) [1754115](#) [1754144](#) [1756913](#)  
[1760051](#) [1760336](#)