

Spezifikation für Freigabe / specification for release

Kunde / customer :
 Artikelnummer / part number : **749013011**
 Bezeichnung : LAN-Übertrager WE-LAN 10/100 BaseT PoE
 description : LAN-Transformer WE-LAN 10/100 BaseT PoE



DATUM / DATE : 2012-09-18

A Mechanische Abmessungen / dimensions :

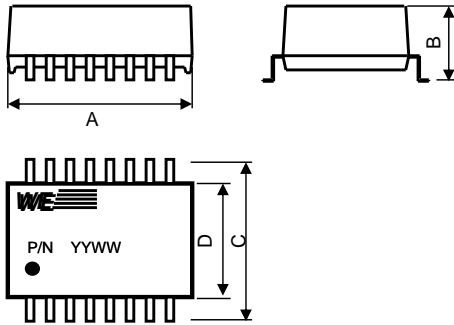

	100 BaseT	
A	12,95 ± 0,25	mm
B	5,33 max.	mm
C	9,65 max.	mm
D	7,11 ± 0,25	mm

● = Pin 1

B Elektrische Eigenschaften / electrical properties :

Eigenschaften / properties	Testbedingungen / test conditions		Wert / value	Einheit / unit	tol.
Induktivität / Inductance	100kHz / 100mV @ 8mA DC-Bias	OCL	350	µH	min.
Übersetzungsverhältnis / Turns ratio	100kHz / 100mV	TR	1 : 1	Tx	2%
			1 : 1	Rx	
Insertion Loss	1-100MHz	IL	-1,1	dB	max.
Return Loss	1-30MHz @ 100Ω	RL	-16	dB	min.
	40MHz @ 100Ω		-14		
	50MHz @ 100Ω		-13		
	60-80MHz @ 100Ω		-12		
Differential to Common Mode Rejection	1MHz	DCMR	-35	dB	min.
	60MHz		-35		
	100MHz		-35		
Crosstalk	1MHz	CT	-35	dB	min.
	100MHz		-35		

C Lötpad / soldering spec. :

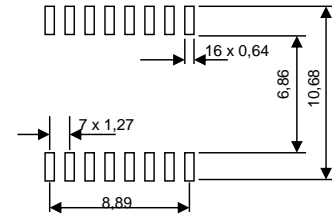

D Prüfgeräte / test equipment :

HP4395A

E Testbedingungen / test conditions :

Luftfeuchtigkeit / humidity: 33%
 Umgebungstemperatur / temperature: +25°C

F Werkstoffe & Zulassungen / material & approvals :

Basismaterial / base material: Ferrit/ ferrite
 Draht / wire: 4UEW 155°C
 Kontaktmaterial/ contact plating: Cu-Ni-Sn
 Verguss / potting: UL94-V0

G Eigenschaften / general specifications :

Betriebstemp. / operating temperature: -40°C - + 85°C
 Hochspannungsprüfung / Hipot test: 1500Vrms 1min.
 Geeignet für PoE-Anwendungen gemäß IEEE 802.3af /
 Compliant with IEEE 802.3af for PoE-Applications
 Coplanarität / Coplanarity: < 0,1 mm
 Auto MDIX fähig / Auto MDIX capable

Freigabe erteilt / general release:	Kunde / customer		
.....			
Datum / date	Unterschrift / signature		
	Würth Elektronik		
.....			
Geprüft / checked	Kontrolliert / approved	Mle	Version 2
		Mle	Version 1
		Name	Änderung / modification
			Datum / date

Würth Elektronik eiSos GmbH & Co.KG

D-74638 Waldenburg · Max-Eyth-Straße 1 - 3 · Germany · Telefon (+49) (0) 7942 - 945 - 0 · Telefax (+49) (0) 7942 - 945 - 400
<http://www.we-online.com>

Spezifikation für Freigabe / specification for release

Kunde / customer :
 Artikelnummer / part number : **749013011**
 Bezeichnung : **LAN-Übertrager WE-LAN 10/100 BaseT PoE**
 description : **LAN-Transformer WE-LAN 10/100 BaseT PoE**



DATUM / DATE : 2012-09-18

H Schaltbild / Schematics :

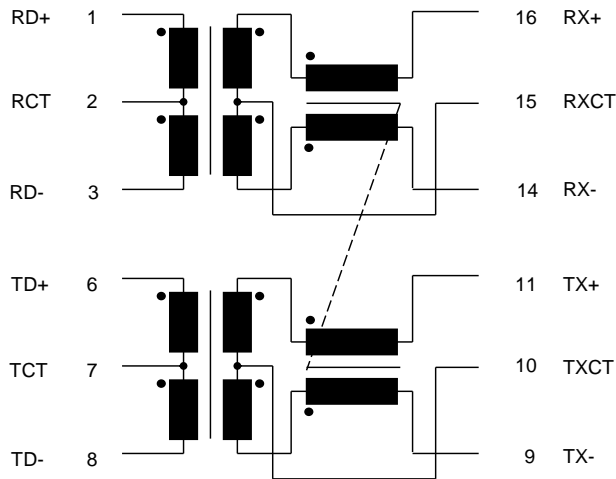

Freigabe erteilt / general release:	Kunde / customer			
.....			
Datum / date	Unterschrift / signature			
	Würth Elektronik			
.....			
Geprüft / checked	Kontrolliert / approved	Mle	Version 2	2012-09-18
		Mle	Version 1	2012-09-03
		Name	Änderung / modification	Datum / date

Würth Elektronik eiSos GmbH & Co.KG

D-74638 Waldenburg · Max-Eyth-Straße 1 · 3 · Germany · Telefon (+49) (0) 7942 - 945 - 0 · Telefax (+49) (0) 7942 - 945 - 400
<http://www.we-online.com>

Spezifikation für Freigabe / specification for release

Kunde / customer :
 Artikelnummer / part number : **749013011**
 Bezeichnung : **LAN-Übertrager WE-LAN 10/100 BaseT PoE**
 description : **LAN-Transformer WE-LAN 10/100 BaseT PoE**



DATUM / DATE : 2012-09-18

I Rollenspezifikation / tape and reel specification :

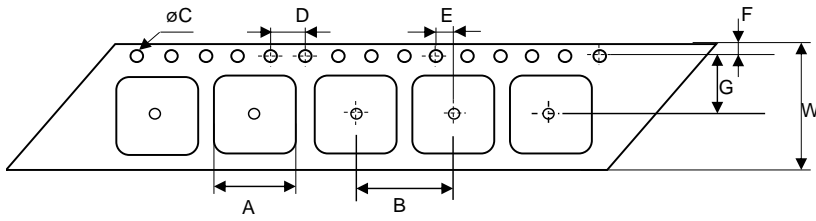

Gurtspezifikation / Tape specification:		
A	9,8 ± 0,1	mm
B	12,0 ± 0,1	mm
C	1,50 +0,1 - 0,0	mm
D	4,00 ± 0,1	mm
E	2,00 ± 0,1	mm
F	1,75 ± 0,1	mm
G	11,5 ± 0,1	mm
H	13 ± 0,1	mm
I	6,8 ± 0,1	mm
W	24,0 ± 0,2	mm

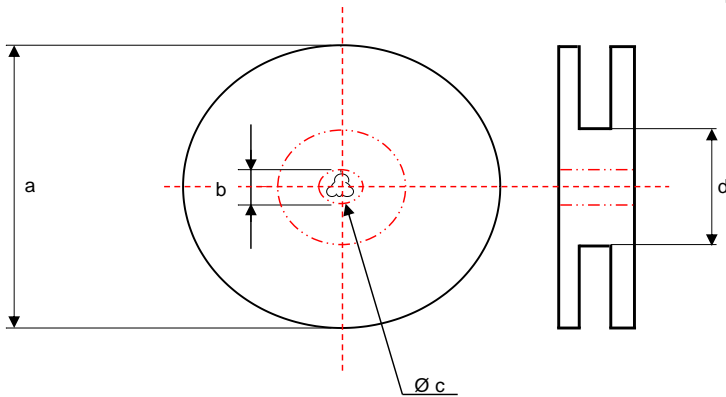
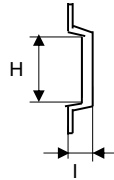

Rollenspezifikation / Reel specification:		
a	330,0 ± 2,0	mm
b	21,00 ± 0,8	mm
c	13,50 ± 0,5	mm
d	100,0 ± 1,0	mm

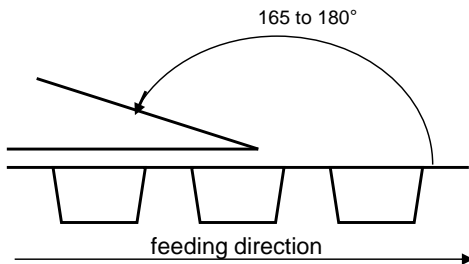

The force for tearing off cover tape is 10 to 130 grams in arrow direction

Freigabe erteilt / general release:	Kunde / customer		
	Datum / date	Unterschrift / signature	
	Würth Elektronik		
Geprüft / checked	Kontrolliert / approved	Mle	Version 2 2012-09-18
		Mle	Version 1 2012-09-03
		Name	Änderung / modification Datum / date

This electronic component has been designed and developed for usage in general electronic equipment. Before incorporating this component into any equipment where higher safety and reliability is especially required or if there is the possibility of direct damage or injury to human body, for example in the range of aerospace, aviation, nuclear control, submarine, transportation, (automotive control, train control, ship control), transportation signal, disaster prevention, medical, public information network etc, Würth Elektronik eiSos GmbH must be informed before the design-in stage. In addition, sufficient reliability evaluation checks for safety must be performed on every electronic component which is used in electrical circuits that require high safety and reliability functions or performance.

Würth Elektronik eiSos GmbH & Co.KG

D-74638 Waldenburg · Max-Eyth-Straße 1 · 3 · Germany · Telefon (+49) (0) 7942 - 945 - 0 · Telefax (+49) (0) 7942 - 945 - 400
<http://www.we-online.com>

X-ON Electronics

Largest Supplier of Electrical and Electronic Components

Click to view similar products for [Audio Transformers](#) / [Signal Transformers](#) category:

Click to view products by [Wurth](#) manufacturer:

Other Similar products are found below :

[CX2041NLT](#) [MGPWT-00449-P](#) [PE-64961](#) [H1302FNLT](#) [H5008FNL](#) [H5012FNL](#) [H5020FNLT](#) [H5077NLT](#) [H5079NLT](#) [H5084FNLT](#)
[B78476A9558A003](#) [1812WBT2-4](#) [1879479-1](#) [HX2260FNL](#) [HX5014FNL](#) [EX2024FNL](#) [FL1066](#) [T1137NLT](#) [T3012NL](#) [PE-65812FNL](#) [PE-65848FNLT](#) [H1174FNL](#) [H1302FNL](#) [H5015FNL](#) [H5019EFNL](#) [H5062FNLT](#) [CX2047LNL](#) [MGPWT-00059-P](#) [MGPWT-00266-P](#) [MGPWT-00278-P](#) [MGPWT-00431-P](#) [TTC-100](#) [TTC-143-H](#) [TTC-5032-1](#) [BX1194WNLT](#) [HX1234NLT](#) [HX5008FNLT](#) [HX5019FNL](#) [HX5084NL](#) [3-1879385-5](#) [TX1263NLT](#) [4-1879391-0](#) [T1142NL](#) [HX6101FNL](#) [HX5084FNL](#) [HX1148NL](#) [HX5020FNLT](#) [HX5014FNLT](#) [T1124NL](#)
[1879732-1](#)