



## Quartz Crystal Specification

IQD Part No. + Packaging: LFX TAL012313Reel

Würth Part No. 830012313



### Description

- Industry standard SMD crystal  
Resistance welded, hermetically sealed in an inert atmosphere, glass to metal seals on leads  
Lead wires are mounted onto a plastic former to create a gull wing mount
- Model: HC49/4HSMX
- Model Issue number: 17

### Frequency Parameters

- Frequency: 14.74560MHz
- Frequency Tolerance:  $\pm 30.00$ ppm
- Tolerance Condition: @ 25°C  $\pm 2^\circ\text{C}$
- Frequency Stability:  $\pm 50.00$ ppm
- Operating Temperature Range: -10.00 to 60.00°C
- Overtone Order: Fundamental
- Ageing:  $\pm 5$ ppm typ per year @ 25°C

### Electrical Parameters

- Load Capacitance (CL): 30.00pF
- Shunt Capacitance (C0): 7pF max
- Drive Level: 500 $\mu$ W max
- ESR: 40.00 $\Omega$  max

### Environmental Parameters

- Shock: 981m/s<sup>2</sup>, 6ms, 3 times in each of 3 mutually perpendicular planes
- Vibration: 10Hz-60Hz, 0.75mm amplitude, 60Hz-500Hz, 98.1m/s<sup>2</sup>, 30mins in 3 mutually perpendicular planes
- Storage Temperature Range: -55 to 125°C

### Manufacturing Details

- RoHS Terminations: SnAgCu or Sn
- RoHS Reflow Temp: 260degC 10s

### Compliance

- RoHS Status (2011/65/EU): Compliant
- REACH Status: Compliant
- MSL Rating (JDEC-STD-033): Not Applicable

### Packaging Details

- Pack Style: Reel Tape & reel in accordance with EIA-481-D  
Pack Size: 1,000
- Alternative packing option available

### USEFUL LINKS

#### Toolbox:

[www.we-online.com/toolbox](http://www.we-online.com/toolbox)

#### Product Catalog:

[www.we-online.com/products](http://www.we-online.com/products)



### Outline (mm)

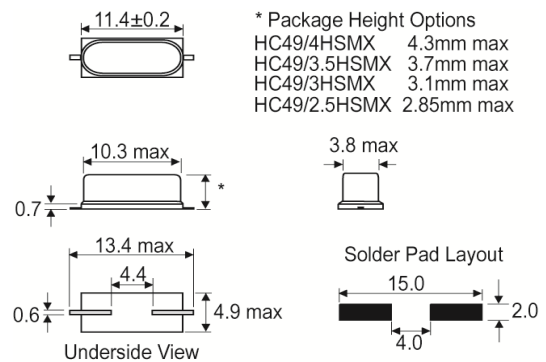

### Typical Frequency vs Temperature Curves



### CONTACT INFORMATION:

Würth Elektronik eiSos GmbH & Co. KG  
 Max-Eyth-Str. 1, 74638 Waldenburg, Germany  
 Tel: +49(0) 7942 945-0

Email: [eiSos@we-online.de](mailto:eiSos@we-online.de)  
 Web: [www.we-online.com](http://www.we-online.com)

## X-ON Electronics

Largest Supplier of Electrical and Electronic Components

*Click to view similar products for [Crystals](#) category:*

*Click to view products by [Wurth](#) manufacturer:*

Other Similar products are found below :

[MC405 32.0000K-R3:PURE SN](#) [7B-27.000MBBK-T](#) [MP1-8.0 99-BU](#) [9B-15.360MBBK-B](#) [PTX-A2JM-10.000M](#) [9C-7.680MBBK-T](#) [H10S-12.000-18-EXT-TR](#) [R38-32.768-12.5-5PPM-NPB](#) [BTD1062E05A-513](#) [C711980XFAS30XX](#) [21U15A-21.4MHZ](#) [RTX-781DF1-S-20.950](#) [LFX TAL066198Cutt](#) [9C-14.31818MBBK-T](#) [A-11.000MHZ-27](#) [SPT2A-.032768B](#) [SPT2A.032768G](#) [SSPT7F-9PF20-R](#) [FX325BS-38.88EEM1201](#) [MP-1-25.000MHZ-3L](#) [MP-1-6.000MHZ](#) [LFX TAL065253Cutt](#) [LFX TAL066431Cutt](#) [XT9S20ANA14M7456](#) [XT9SNLANA16M](#) [646G-24-2](#) [7B-30.000MBBK-T](#) [6504-202-1501](#) [6526-202-1501](#) [BTJ120E02C](#) [SG636PCE-20.000MC](#) [3404](#) [CM315D32768EZFT](#) [C1E-24.000-7-2020-R](#) [C1E-19.200-12-1530-X-R](#) [C1E-16.000-12-1530-X-R](#) [ABM11-16.000MHZ-9-B1U-T](#) [FL5000014](#) [EUCA18-3.1872M](#) [425F35E027M0000](#) [17196](#) [MS3V-T1R-32.768kHz-7pF-20PPM-TA-QC-Au](#) [VXM7-1C1-16M000](#) [MS1V-T1K-32.768kHz-10pF-20PPM-TA-QC-Au](#) [MS1V-T1K-32.768kHz-12.5pF-20PPM-TA-QC-Au](#) [MS3V-T1R-32.768kHz-9pF-20PPM-TA-QC-Au](#) [ECS-80-18-30-JGN-TR](#) [17000](#) [17301](#)