

SOT-23-6L Plastic-Encapsulate MOSFETS

8205A

Dual N-Channel Enhancement Mode MOSFET

PRODUCT SUMMARY		
V _{DSS}	I _D	R _{DS(ON)} (mΩ) Max
20V	5A	27.5 @ V _{GS} =4.5V
		28.5 @ V _{GS} =4.0V
		30.0 @ V _{GS} =3.7V
		33.0 @ V _{GS} =3.1V
		38.0 @ V _{GS} =2.5V

FEATURES

- Super high dense cell design for low R_{DS(ON)}.
- Rugged and reliable.
- Surface Mount Package.
- ESD Protected.

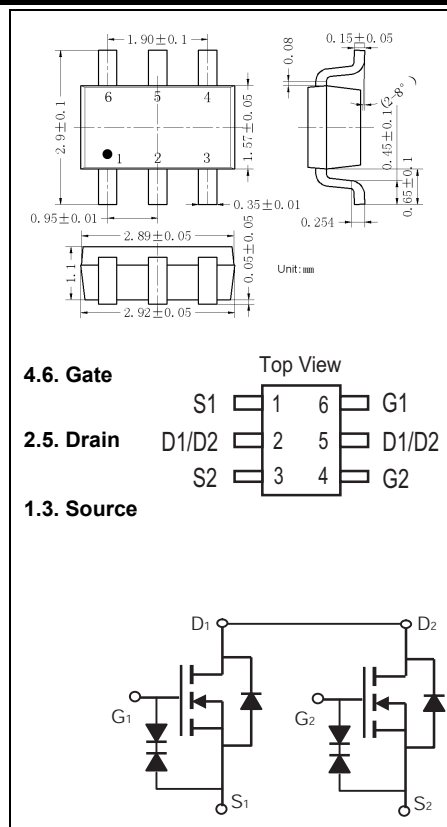

ABSOLUTE MAXIMUM RATINGS (T_A=25°C unless otherwise noted)

Symbol	Parameter	Limit	Units
V _{DS}	Drain-Source Voltage	20	V
V _{GS}	Gate-Source Voltage	±12	V
I _D	Drain Current-Continuous ^c	T _A =25°C	5.0
		T _A =70°C	4.0
I _{DM}	-Pulsed ^{a,c}	20	A
P _D	Maximum Power Dissipation	T _A =25°C	1.25
		T _A =70°C	0.8
T _J , T _{STG}	Operating Junction and Storage Temperature Range	-55 to 150	°C

THERMAL CHARACTERISTICS

R _{θJA}	Thermal Resistance, Junction-to-Ambient	100	°C/W
------------------	---	-----	------

ELECTRICAL CHARACTERISTICS (TA=25°C unless otherwise noted)

Symbol	Parameter	Conditions	Min	Typ	Max	Units
OFF CHARACTERISTICS						
BV _{DSS}	Drain-Source Breakdown Voltage	V _{GS} =0V, I _D =250uA	20			V
I _{DSS}	Zero Gate Voltage Drain Current	V _{DS} =16V, V _{GS} =0V			1	uA
I _{GSS}	Gate-Body Leakage Current	V _{GS} = ±12V, V _{DS} =0V			±10	uA
ON CHARACTERISTICS						
V _{GS(th)}	Gate Threshold Voltage	V _{DS} =V _{GS} , I _D =1mA	0.5	0.9	1.5	V
R _{DS(ON)}	Drain-Source On-State Resistance	V _{GS} =4.5V, I _D =2.5A	20.0	23.0	27.5	m ohm
		V _{GS} =4.0V, I _D =2.5A	21.0	24.0	28.5	m ohm
		V _{GS} =3.7V, I _D =2.5A	22.0	25.0	30.0	m ohm
		V _{GS} =3.1V, I _D =2.5A	23.0	27.0	33.0	m ohm
		V _{GS} =2.5V, I _D =2.5A	25.0	31.0	38.0	m ohm
g _{FS}	Forward Transconductance	V _{DS} =5V, I _D =2.5A		15		S
DYNAMIC CHARACTERISTICS ^b						
C _{ISS}	Input Capacitance	V _{DS} =10V, V _{GS} =0V f=1.0MHz		485		pF
C _{OSS}	Output Capacitance			155		pF
C _{RSS}	Reverse Transfer Capacitance			135		pF
SWITCHING CHARACTERISTICS ^b						
t _{D(ON)}	Turn-On Delay Time	V _{DD} =16V I _D =2.5A V _{GS} =4.5V R _{GEN} = 6 ohm		16.5		ns
t _r	Rise Time			36		ns
t _{D(OFF)}	Turn-Off Delay Time			18		ns
t _f	Fall Time			39		ns
Q _g	Total Gate Charge				8.6	
Q _{gs}	Gate-Source Charge	V _{DS} =16V, I _D =5A, V _{GS} =4.5V		1.5		nC
Q _{gd}	Gate-Drain Charge			4.2		nC
DRAIN-SOURCE DIODE CHARACTERISTICS AND MAXIMUM RATINGS						
V _{SD}	Diode Forward Voltage	V _{GS} =0V, I _S =1A		0.78	1.2	V
<p>Notes</p> <p>a. Pulse Test: Pulse Width ≤ 10us, Duty Cycle ≤ 1%.</p> <p>b. Guaranteed by design, not subject to production testing.</p> <p>c. Drain current limited by maximum junction temperature.</p> <p>d. Mounted on FR4 Board of 1 inch², 2oz.</p>						

Typical Characteristics

DERATING FACTOR OF FORWARD BIAS SAFE OPERATING AREA

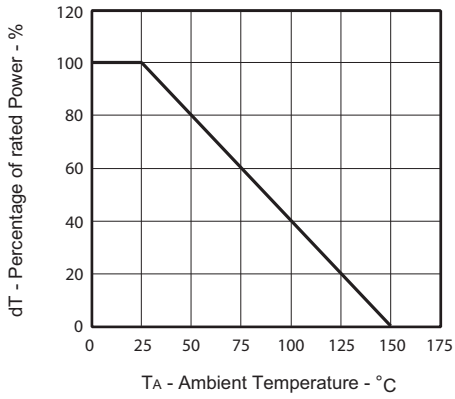

TOTAL POWER DISSIPATION vs. AMBIENT TEMPERATURE

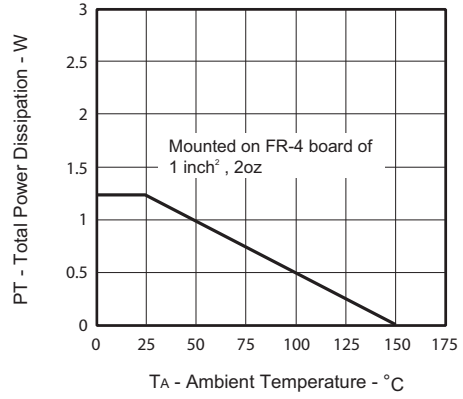

FORWARD BIAS SAFE OPERATING AREA

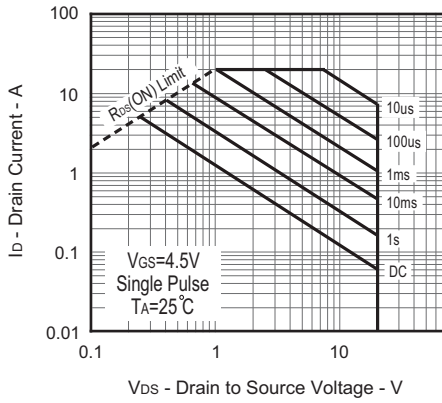

TRANSIENT THERMAL RESISTANCE vs. PULSE WIDTH

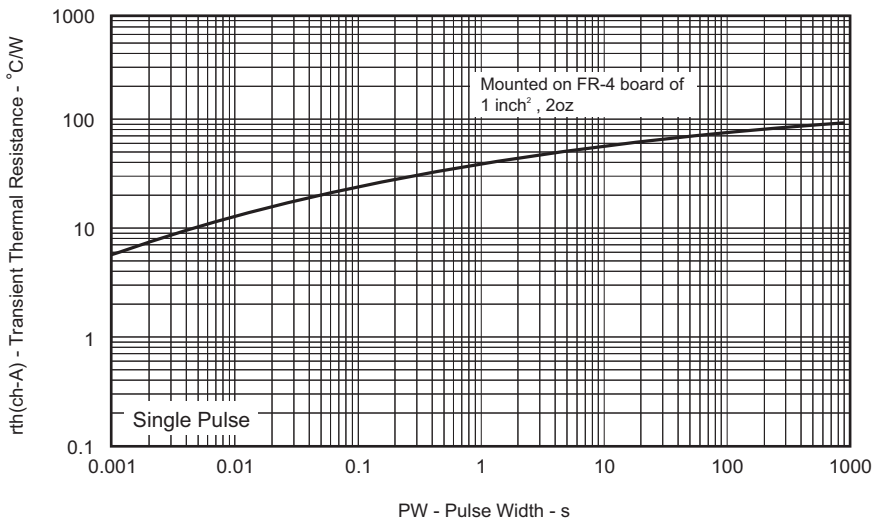

Typical Characteristics

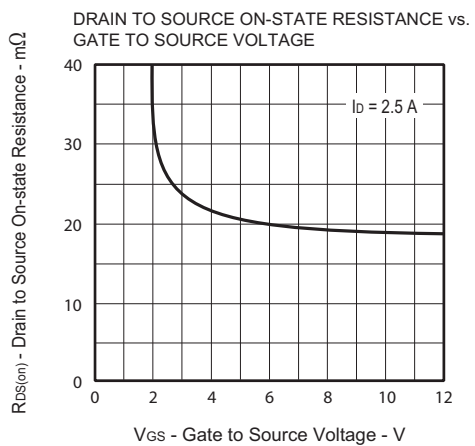
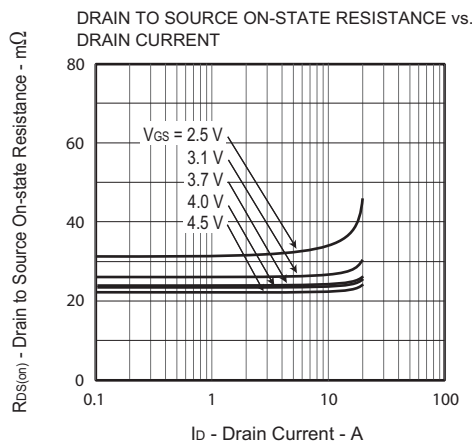
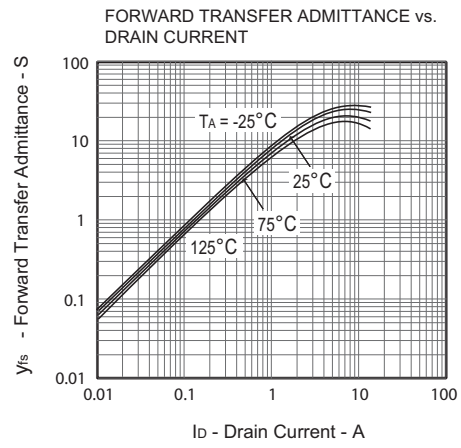
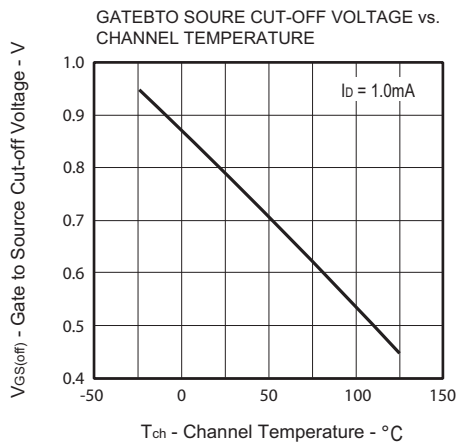
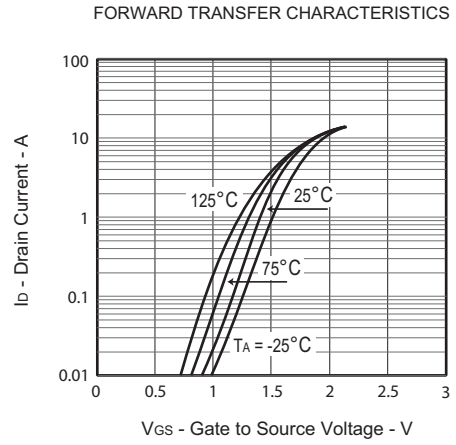
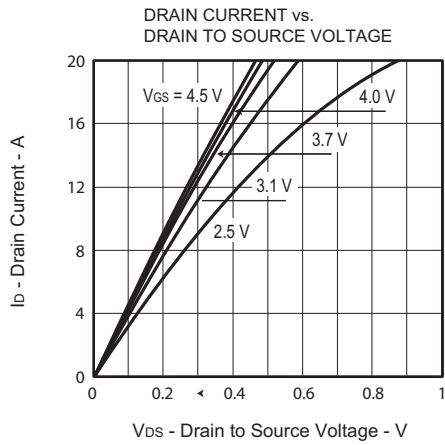

Typical Characteristics

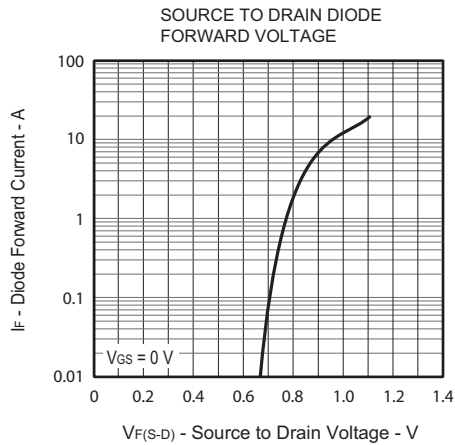
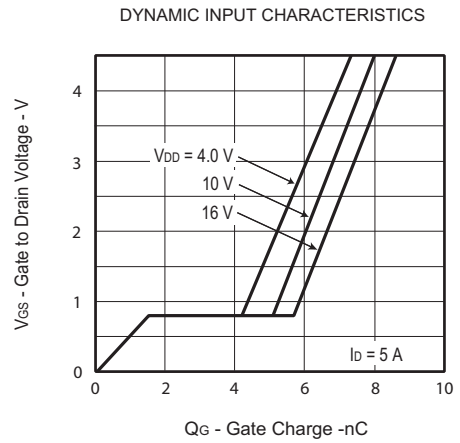
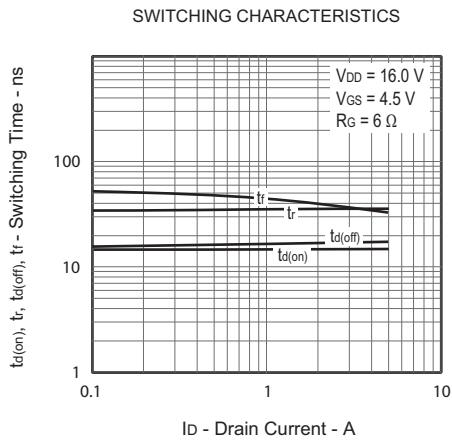
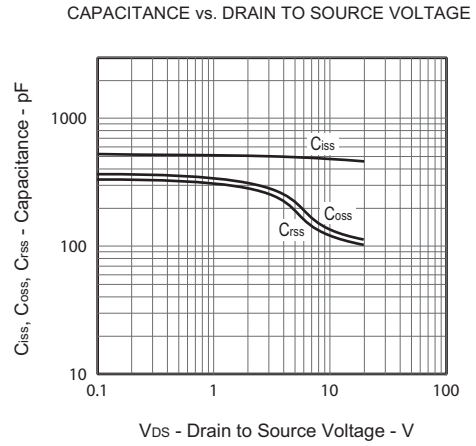
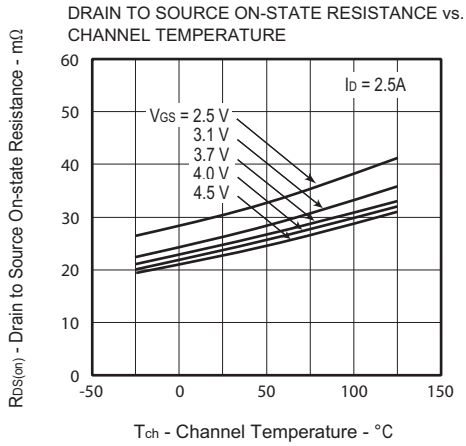

SOT-23-6L Package Outline Dimensions

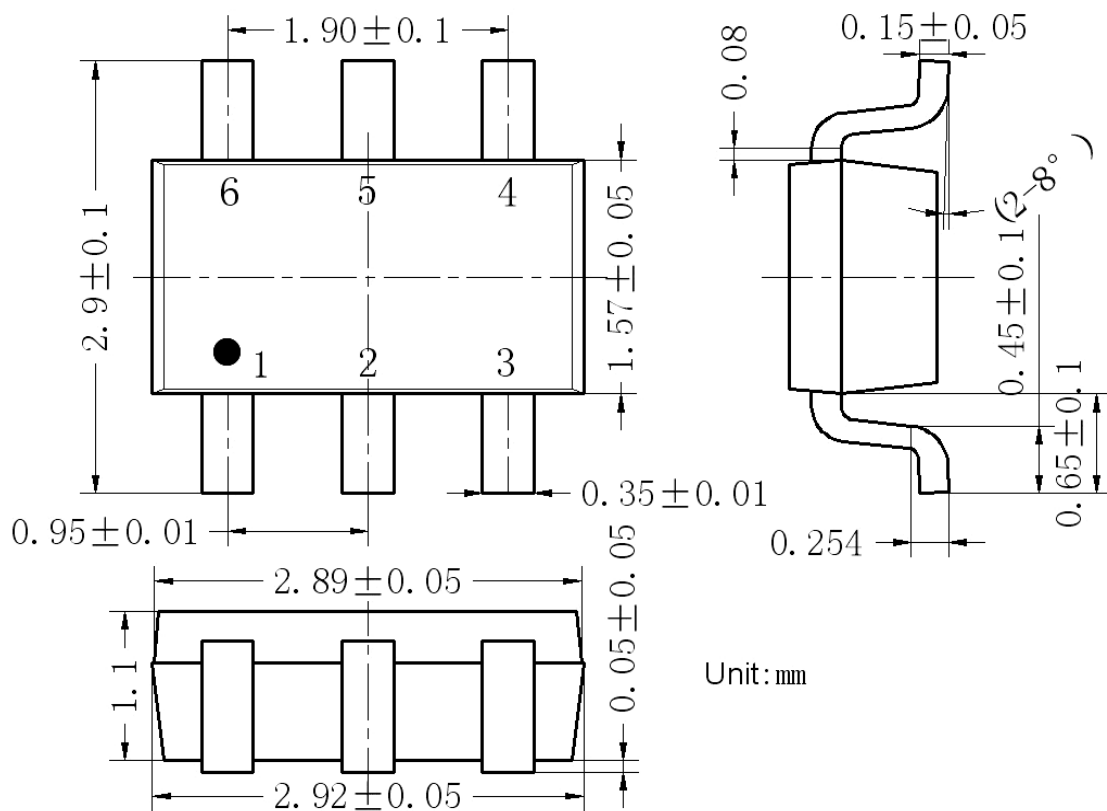

SOT-23-6L Suggested Pad Layout

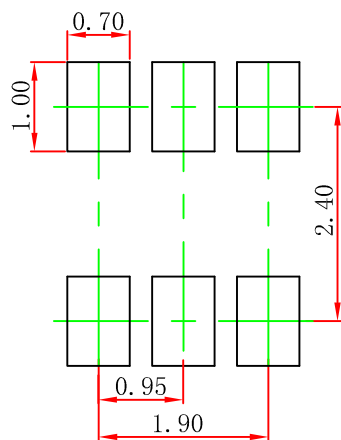

- Note:
- Controlling dimension: in millimeters.
 - General tolerance: ± 0.05 mm.
 - The pad layout is for reference purposes only.

SOT-23-6L Tape and Reel

SOT-23-6L Embossed Carrier Tape

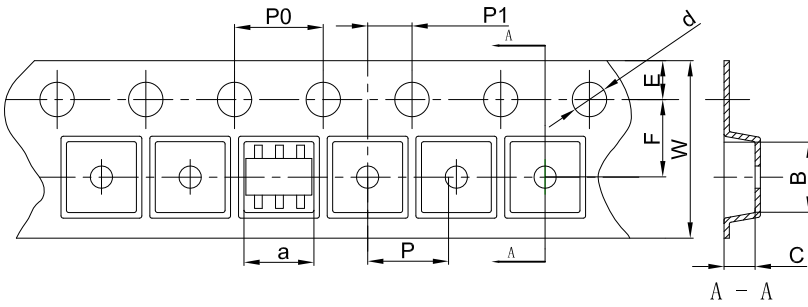

Packaging Description:

SOT-23-6L parts are shipped in tape. The carrier tape is made from a dissipative (carbon filled) polycarbonate resin. The cover tape is a multilayer film (Heat Activated Adhesive in nature) primarily composed of polyester film, adhesive layer, sealant, and anti-static sprayed agent. These reeled parts in standard option are shipped with 3,000 units per 7" or 18.0cm diameter reel. The reels are clear in color and is made of polystyrene plastic (anti-static coated).

Dimensions are in millimeter											
Pkg type	a	B	C	d	E	F	P0	P	P1	W	
SOT-23-6L	3.17	3.23	1.37	Ø1.55	1.75	3.50	4.00	4.00	2.00	8.00	

SOT-23-6L Tape Leader and Trailer

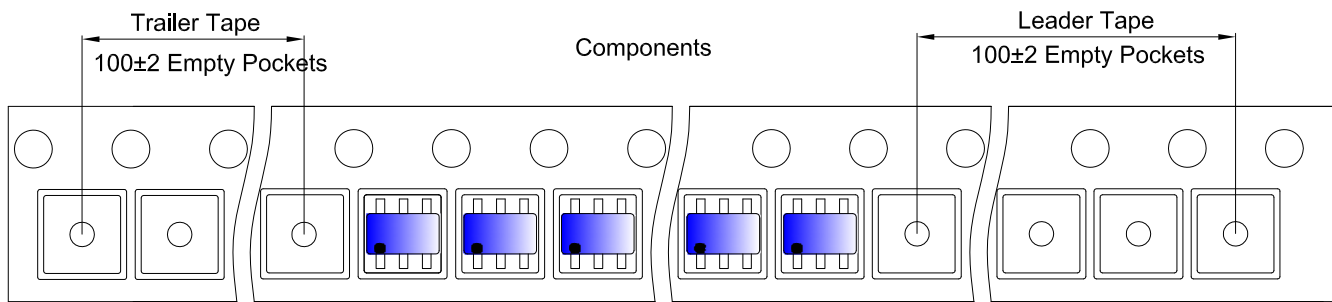

SOT-23-6L Reel

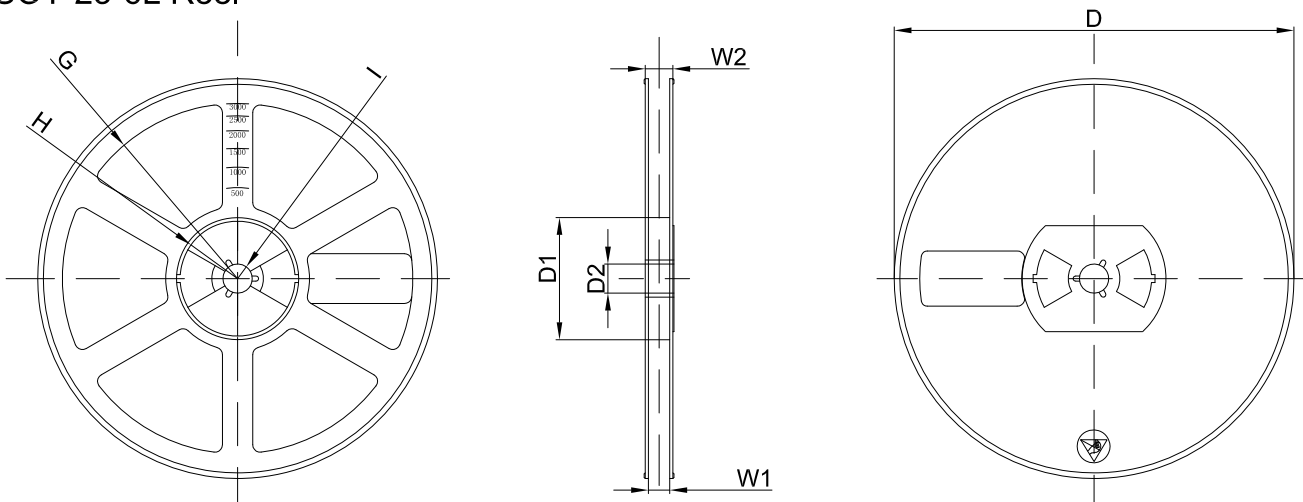

Dimensions are in millimeter								
Reel Option	D	D1	D2	G	H	I	W1	W2
7" Dia	Ø180.00	60.00	13.00	R78.00	R25.60	R6.50	9.50	13.10

REEL	Reel Size	Box	Box Size(mm)	Carton	Carton Size(mm)	G.W.(kg)
3000 pcs	7 inch	30,000 pcs	203×203×195	120,000 pcs	438×438×220	

Soldering Parameters

Reflow Condition		Pb – Free assembly
Pre Heat	Temperature Min ($T_{s(min)}$)	150°C
	Temperature Max ($T_{s(max)}$)	200°C
	Time (min to max) (t_s)	60 – 190 secs
Average ramp up rate (Liquidus Temp) (T_L) to peak		5°C/second max
		5°C/second max
Reflow	Temperature (T_L) (Liquidus)	217°C
	Temperature (t_L)	60 – 150 seconds
		260+0/-5 °C
Time within actual peak Temperature (t_p)		20 – 40 seconds
Ramp-down Rate		5°C/second max
Time 25°C to peak Temperature (T_P)		8 minutes Max.
Do not exceed		280°C

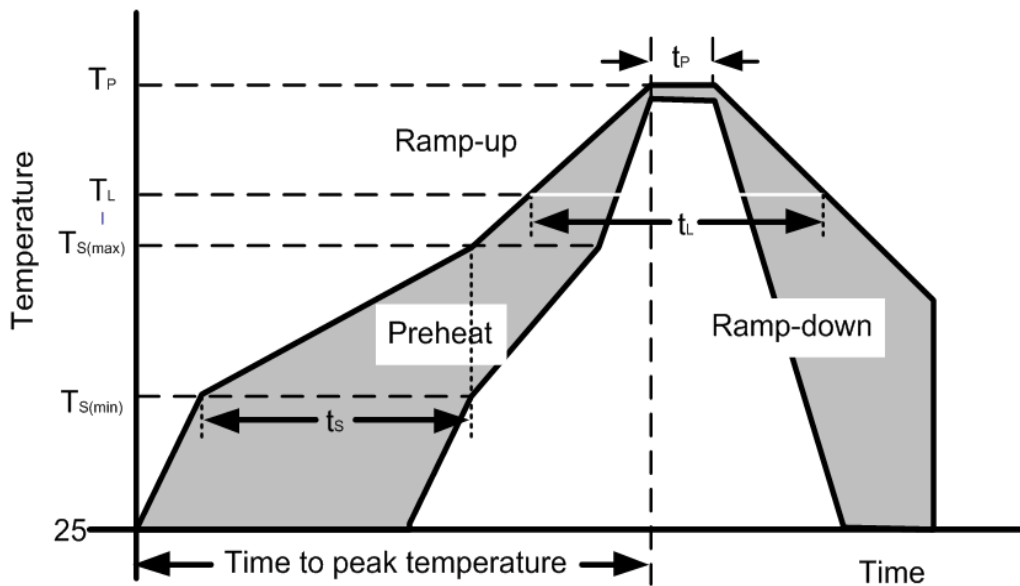

X-ON Electronics

Largest Supplier of Electrical and Electronic Components

Click to view similar products for [MOSFET](#) category:

Click to view products by [XBLW](#) manufacturer:

Other Similar products are found below :

[IRFD120](#) [IRFY240C](#) [JANTX2N5237](#) [2SK2267\(Q\)](#) [BUK455-60A/B](#) [MIC4420CM-TR](#) [VN1206L](#) [NDP4060](#) [SI4482DY](#)
[IPS70R2K0CEAKMA1](#) [SQD23N06-31L-GE3](#) [TK16J60W,S1VQ\(O](#) [2SK2614\(TE16L1,Q\)](#) [DMN1017UCP3-7](#) [EFC2J004NUZTDG](#)
[DMN1053UCP4-7](#) [SQJ469EP-T1-GE3](#) [NTE2384](#) [DMC2700UDMQ-7](#) [DMN2080UCB4-7](#) [DMN61D9UWQ-13](#) [US6M2GTR](#)
[DMN31D5UDJ-7](#) [DMP22D4UFO-7B](#) [DMN1006UCA6-7](#) [DMN16M9UCA6-7](#) [STF5N65M6](#) [IRF40H233XTMA1](#) [STU5N65M6](#)
[DMN6022SSD-13](#) [DMN13M9UCA6-7](#) [DMTH10H4M6SPS-13](#) [DMN2990UFB-7B](#) [IPB80P04P405ATMA2](#) [2N7002W-G](#) [MCAC30N06Y-](#)
[TP](#) [MCQ7328-TP](#) [NTMC083NP10M5L](#) [NVMFS2D3P04M8LT1G](#) [BXP7N65D](#) [BXP4N65F](#) [AOL1454G](#) [WMJ80N60C4](#) [BXP2N20L](#)
[BXP2N65D](#) [BXT1150N10J](#) [BXT1700P06M](#) [TSM60NB380CP](#) [ROG](#) [RQ7L055BGTCR](#) [DMNH15H110SK3-13](#)