

PIM with Trench Field-Stop IGBT, Emitter Controlled Diode and NTC

Features

- Low Switching Losses
- 1200V Trench Field-Stop IGBT
- Low $V_{CE(sat)}$ with Positive Temperature Coefficient

Applications

- Auxiliary Inverters
- Air Conditioning
- Motor Drives
- Uninterruptive Power Supply (UPS)

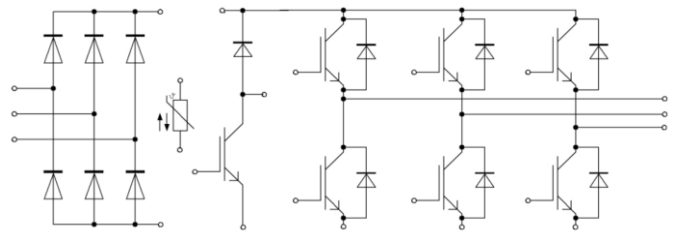

IGBT - Inverter

Maximum Rated Values

Symbol	Description	Conditions	Values	Unit
V_{CES}	Collector-Emitter Voltage	$T_{vj}=25^{\circ}\text{C}$	1200	V
V_{GES}	Gate-Emitter Voltage	$T_{vj}=25^{\circ}\text{C}$	± 20	V
I_C	Continuous DC Collector Current	$T_C=25^{\circ}\text{C}$	30	A
	Continuous DC Collector Current	$T_C=100^{\circ}\text{C}$	15	A
I_{CRM}	Repetitive Peak Collector Current	$t_p=1\text{ms}$	30	A
P_{tot}	Total Power Dissipation	$T_C=25^{\circ}\text{C}, T_{vj,max}=175^{\circ}\text{C}$	130	W

Characteristic Values

Symbol	Description	Conditions	Values			Unit
			Min.	Typ.	Max.	
$V_{CE(sat)}$	Collector-Emitter Saturation Voltage	$V_{GE}=15V, I_C=15A, T_{vj}=25^{\circ}C$	---	1.90	2.25	V
		$V_{GE}=15V, I_C=15A, T_{vj}=125^{\circ}C$	---	2.40	--	V
$V_{GE(th)}$	Gate Threshold Voltage	$V_{GE}=V_{CE}, I_C=480\mu A$	5.2	5.8	6.4	V
I_{CES}	Collector-Emitter Leakage Current	$V_{CE}=1200V, V_{GE}=0V$	---	---	1	mA
I_{GES}	Gate Leakage Current	$V_{GE}=\pm 20V, V_{CE}=0V$	---	---	± 400	nA
Q_G	Total Gate Charge	$V_{CC}=960V, V_{GE}=15V, I_C=15A$	---	68	---	nC
C_{ies}	Input Capacitance	$V_{CE}=25V, V_{GE}=0V, f=1MHz$	---	903	---	pF
C_{res}	Reverse Transfer Capacitance		---	48	---	pF
$t_{d(on)}$	Turn-on Delay Time	$V_{CC}=600V$ $V_{GE}=\pm 15V$ $I_C=15A$ $R_G=39\Omega$ Inductive Load $T_{vj}=25^{\circ}C$	---	112	---	ns
t_r	Turn-on Rise Time		---	54	---	ns
$t_{d(off)}$	Turn-off Delay Time		---	112	---	ns
t_f	Turn-off Fall Time		---	284	---	ns
E_{on}	Turn-on Switching Loss		---	5.18	---	mJ
E_{off}	Turn-off Switching Loss		---	1.01	---	mJ
$t_{d(on)}$	Turn-on Delay Time	$V_{CC}=600V$ $V_{GE}=\pm 15V$ $I_C=15A$ $R_G=39\Omega$ Inductive Load $T_{vj}=125^{\circ}C$	---	92	---	ns
t_r	Turn-on Rise Time		---	52	---	ns
$t_{d(off)}$	Turn-off Delay Time		---	198	---	ns
t_f	Turn-off Fall Time		---	376	---	ns
E_{on}	Turn-on Switching Loss		---	7.93	---	mJ
E_{off}	Turn-off Switching Loss		---	1.58	---	mJ
I_{SC}	SC data	$V_{GE}\leq 15V, V_{CC}=600V$ $t_p\leq 10\mu s, T_{vj}=25^{\circ}C$	---	37.26	---	A
R_{thJC}	Thermal Resistance, Junction to Case	per IGBT	---	1.00	1.15	K/W
R_{thCH}	Thermal Resistance, Case to Heatsink	per IGBT $\lambda_{paste}=1W/(m\cdot k), \lambda_{grease}=1W/(m\cdot k)$	---	1.05	---	K/W
T_{VJOP}	Virtual Junction Temperature	under Switching	-40	---	150	$^{\circ}C$

Diode - Inverter Maximum Rated Values

Symbol	Description	Conditions	Values	Unit
V_{RRM}	Repetitive Peak Reverse Voltage	$T_{vj}=25^{\circ}C$	1200	V
I_F	Gate-Emitter Voltage		15	A
I_{FRM}	Repetitive Peak Collector Current	$t_p=1ms$	30	A

Characteristic Values

Symbol	Description	Conditions	Values			Unit
			Min.	Typ.	Max.	
V _F	Forward Voltage	I _F =15A, V _{GE} =0V, T _{vj} =25°C	---	2.0	2.4	V
		I _F =15A, V _{GE} =0V, T _{vj} =125°C	---	1.6	---	V
I _{RM}	Peak Reverse Recovery Current	I _F =15A, di/dt=250A/us V _R =600V, V _{GE} =-15V T _{vj} =25°C	---	10.67	---	A
Q _r	Recovered Charge		---	1.05	---	uC
E _{rec}	Reverse Recovery Energy		---	0.27	---	mJ
I _{RM}	Peak Reverse Recovery Current	I _F =15A, di/dt=250A/us V _R =600V, V _{GE} =-15V T _{vj} =125°C	---	14.31	---	A
Q _r	Recovered Charge		---	2.95	---	uC
E _{rec}	Reverse Recovery Energy		---	0.59	---	mJ
R _{thJC}	Thermal Resistance, Junction to Case	per Diode	---	1.75	2	K/W
R _{thCH}	Thermal Resistance, Case to Heatsink	per IGBT λ _{Paste} =1W/(m·k), λ _{Grease} =1W/(m·k)	---	1.35	---	K/W
T _{VJ OP}	Virtual Junction Temperature	under Switching	-40	---	150	°C

Diode - Rectifier Maximum Rated Values

Symbol	Description	Conditions	Values	Unit
V _{RRM}	Repetitive Peak Reverse Voltage	T _{vj} =25°C	1600	V
I _{F(AV)}	Average Output Current	T _{vj} =25°C	16	A
I _{FSM}	Surge Forward Current	t _p =10ms, sin180°, T _j =25°C	160	A
I ² t	I ² t Value	t _p =10ms, sin180°, T _j =25°C	128	A ² s

Characteristic Values

Symbol	Description	Conditions	Values			Unit
			Min.	Typ.	Max.	
V _F	Forward Voltage	I _F =15A, V _{GE} =0V, T _{vj} =25°C	---	1.0	1.2	V
I _R	Recovery Current	V _R =1600V	---	---	1.0	mA
R _{thJC}	Thermal Resistance, Junction to Case	per Diode	---	1.25	1.38	K/W
R _{thCH}	Thermal Resistance, Case to Heatsink	per Diode λ _{Paste} =1W/(m·k), λ _{Grease} =1W/(m·k)	---	1.18	---	K/W
T _{VJ OP}	Virtual Junction Temperature	under Switching	-40	---	150	°C

IGBT – Brake Maximum Rated Values

Symbol	Description	Conditions	Values	Unit
V_{CES}	Collector-Emitter Voltage	$T_{vj}=25^{\circ}\text{C}$	1200	V
V_{GES}	Gate-Emitter Voltage	$T_{vj}=25^{\circ}\text{C}$	± 20	V
I_C	Continuous DC Collector Current	$T_C=25^{\circ}\text{C}$	30	A
	Continuous DC Collector Current	$T_C=100^{\circ}\text{C}$	15	A
I_{CRM}	Repetitive Peak Collector Current	$t_p=1\text{ms}$	30	A
P_{tot}	Total Power Dissipation	$T_C=25^{\circ}\text{C}, T_{vj\text{max}}=175^{\circ}\text{C}$	130	W

Characteristic Values

Symbol	Description	Conditions	Values			Unit	
			Min.	Typ.	Max.		
$V_{CE(sat)}$	Collector-Emitter Saturation Voltage	$V_{GE}=15\text{V}, I_C=15\text{A}, T_{vj}=25^{\circ}\text{C}$	---	1.90	2.25	V	
		$V_{GE}=15\text{V}, I_C=15\text{A}, T_{vj}=125^{\circ}\text{C}$	---	2.40	--	V	
$V_{GE(th)}$	Gate Threshold Voltage	$V_{GE}=V_{CE}, I_C=480\mu\text{A}$	5.2	5.8	6.4	V	
I_{CES}	Collector-Emitter Leakage Current	$V_{CE}=1200\text{V}, V_{GE}=0\text{V}$	---	---	1	mA	
I_{GES}	Gate Leakage Current	$V_{GE}=\pm 20\text{V}, V_{CE}=0\text{V}$	---	---	± 400	nA	
Q_G	Total Gate Charge	$V_{CC}=960\text{V}, V_{GE}=15\text{V}, I_C=15\text{A}$	---	68	---	nC	
C_{ies}	Input Capacitance	$V_{CE}=25\text{V}, V_{GE}=0\text{V}, f=1\text{MHz}$	---	903	---	pF	
C_{res}	Reverse Transfer Capacitance		---	48	---	pF	
$t_{d(on)}$	Turn-on Delay Time	$V_{CC}=600\text{V}$ $V_{GE}=\pm 15\text{V}$ $I_C=15\text{A}$ $R_G=39\Omega$ Inductive Load $T_{vj}=25^{\circ}\text{C}$	---	112	---	ns	
t_r	Turn-on Rise Time		---	54	---	ns	
$t_{d(off)}$	Turn-off Delay Time		---	112	---	ns	
t_f	Turn-off Fall Time		---	284	---	ns	
E_{on}	Turn-on Switching Loss		---	5.18	---	mJ	
E_{off}	Turn-off Switching Loss		---	1.01	---	mJ	
$t_{d(on)}$	Turn-on Delay Time		$V_{CC}=600\text{V}$ $V_{GE}=\pm 15\text{V}$ $I_C=15\text{A}$ $R_G=39\Omega$ Inductive Load $T_{vj}=125^{\circ}\text{C}$	---	92	---	ns
t_r	Turn-on Rise Time			---	52	---	ns
$t_{d(off)}$	Turn-off Delay Time	---		198	---	ns	
t_f	Turn-off Fall Time	---		376	---	ns	
E_{on}	Turn-on Switching Loss	---		7.93	---	mJ	
E_{off}	Turn-off Switching Loss	---		1.58	---	mJ	
I_{SC}	SC data	$V_{GE}\leq 15\text{V}, V_{CC}=600\text{V}$ $t_p\leq 10\mu\text{s}, T_{vj}=25^{\circ}\text{C}$		---	37.26	---	A
R_{thJC}	Thermal Resistance, Junction to Case	per IGBT		---	1.00	1.15	K/W
R_{thCH}	Thermal Resistance, Case to Heatsink	per IGBT $\lambda_{Paste}=1\text{W}/(\text{m}\cdot\text{k}), \lambda_{Grease}=1\text{W}/(\text{m}\cdot\text{k})$	---	1.05	---	K/W	
T_{VJOP}	Virtual Junction Temperature	under Switching	-40	---	150	$^{\circ}\text{C}$	

Diode - Brake Maximum Rated Values

Symbol	Description	Conditions	Values	Unit
V_{RRM}	Repetitive Peak Reverse Voltage	$T_{vj}=25^{\circ}\text{C}$	1200	V
I_F	Gate-Emitter Voltage		10	A
I_{FRM}	Repetitive Peak Collector Current	$t_p=1\text{ms}$	20	A

Characteristic Values

Symbol	Description	Conditions	Values			Unit
			Min.	Typ.	Max.	
V_F	Forward Voltage	$I_F=10\text{A}, V_{GE}=0\text{V}, T_{vj}=25^{\circ}\text{C}$	---	2.2	2.8	V
		$I_F=10\text{A}, V_{GE}=0\text{V}, T_{vj}=125^{\circ}\text{C}$	---	1.8	---	V
I_{RM}	Peak Reverse Recovery Current	$I_F=10\text{A}, di/dt=200\text{A/us}$ $V_R=600\text{V}, V_{GE}=-15\text{V}$ $T_{vj}=25^{\circ}\text{C}$	---	8.34	---	A
Q_r	Recovered Charge		---	0.79	---	μC
E_{rec}	Reverse Recovery Energy		---	0.18	---	mJ
I_{RM}	Peak Reverse Recovery Current	$I_F=10\text{A}, di/dt=200\text{A/us}$ $V_R=600\text{V}, V_{GE}=-15\text{V}$ $T_{vj}=125^{\circ}\text{C}$	---	9.55	---	A
Q_r	Recovered Charge		---	1.07	---	μC
E_{rec}	Reverse Recovery Energy		---	0.24	---	mJ
R_{thJC}	Thermal Resistance, Junction to Case	per Diode	---	1.70	1.85	K/W
R_{thCH}	Thermal Resistance, Case to Heatsink	per IGBT $\lambda_{Paste}=1\text{W}/(\text{m}\cdot\text{k}), \lambda_{Grease}=1\text{W}/(\text{m}\cdot\text{k})$	---	1.30	---	K/W
$T_{VJ OP}$	Virtual Junction Temperature	under Switching	-40	---	150	$^{\circ}\text{C}$

NTC-Thermistor Characteristic Values

Symbol	Description	Conditions	Values			Unit
			Min.	Typ.	Max.	
R_{25}	Rated Resistance	$T_C=25^{\circ}\text{C}$	---	5	---	K Ω
$B_{25/50}$	B Value	$R_2 = R_{25} \exp [B_{25/50}(1/T_2 - 1/(298\text{ K}))]$	---	3375	---	K

Module

Symbol	Description	Conditions	Values	Unit
V_{ISOL}	Isolation Test Voltage	RMS, f=50Hz, t=1min	2.5	KV
	Internal Isolation	Basic Insulation (Class 1, IEC 61140)	Al_2O_3	
	Creepage Distance	Terminal to Heatsink	11.5	mm
		Terminal to Terminal	6.3	
	Clearance	Terminal to Heatsink	10	mm
		Terminal to Terminal	5	
CTI	Comparative Tracking Index		> 200	

Symbol	Description	Conditions	Values			Unit
			Min.	Typ.	Max.	
L_{SCE}	Stray Inductance Module		---	92	---	nH
$R_{CC'+EE'}$ $R_{AA'+CC'}$	Module Lead Resistance, Terminals – Chip	$T_C=25^\circ C$, per Switch	---	8 6	---	m Ω
T_{stg}	Storage Temperature		-40	---	125	$^\circ C$
F	Mounting Force per Clamp		20	---	50	N
G	Weight		---	24	---	g

Typical Characteristics

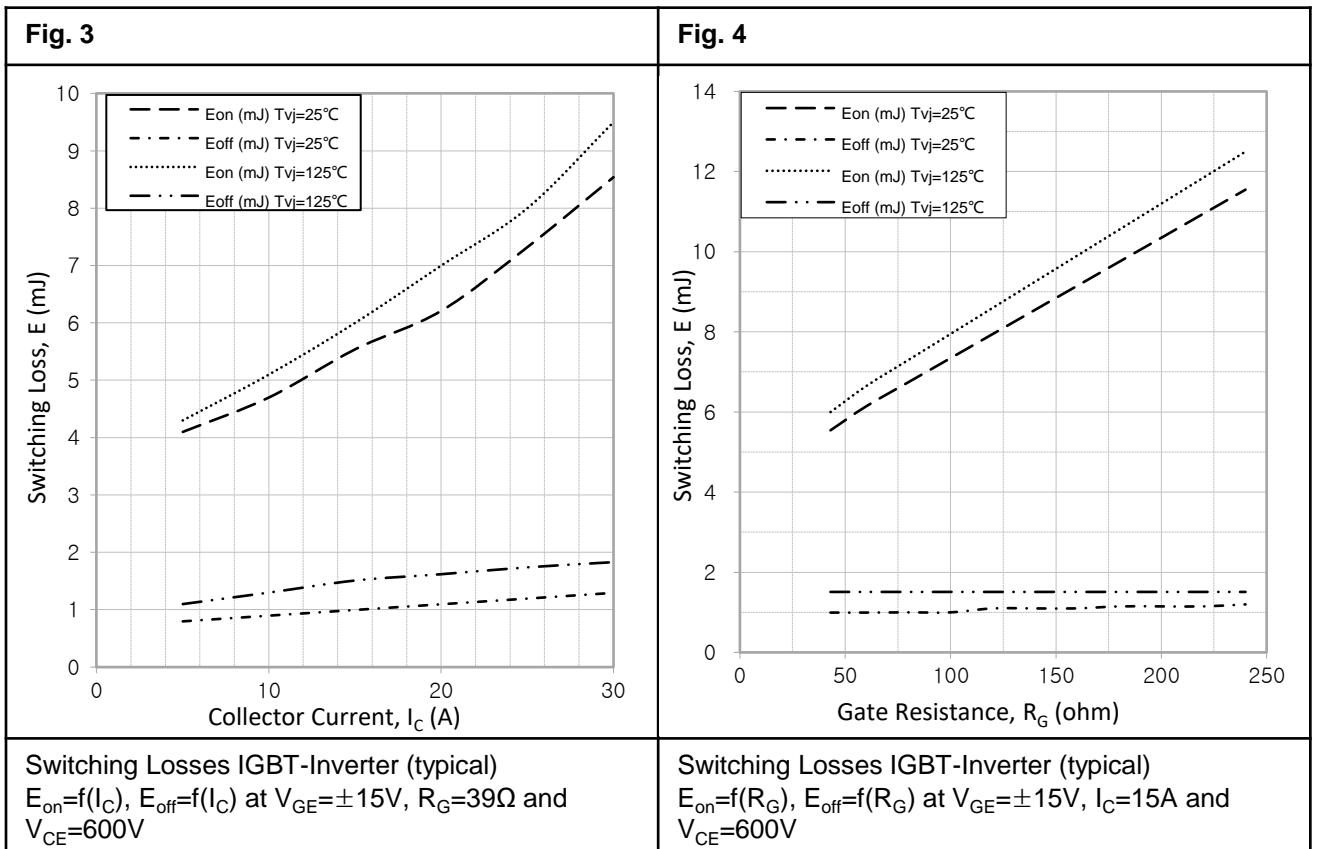
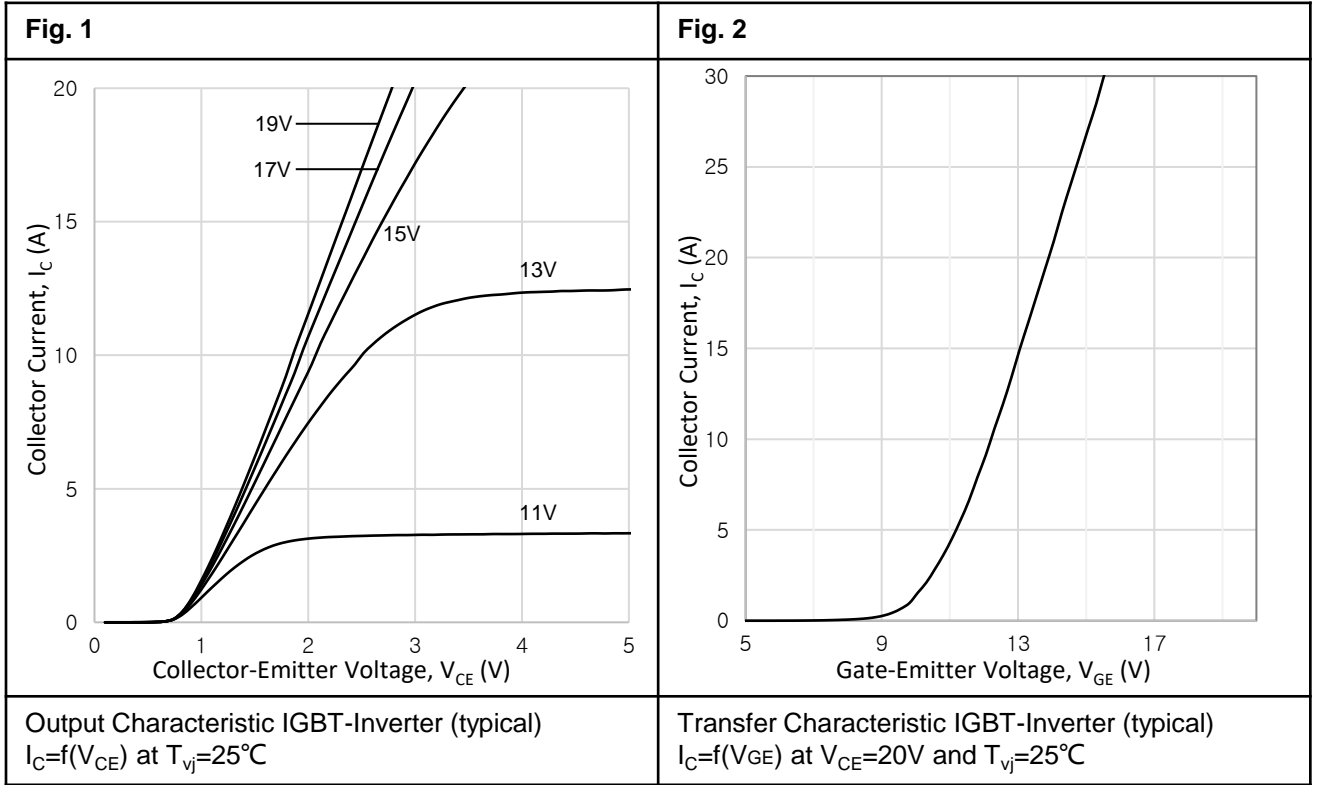

Typical Characteristics

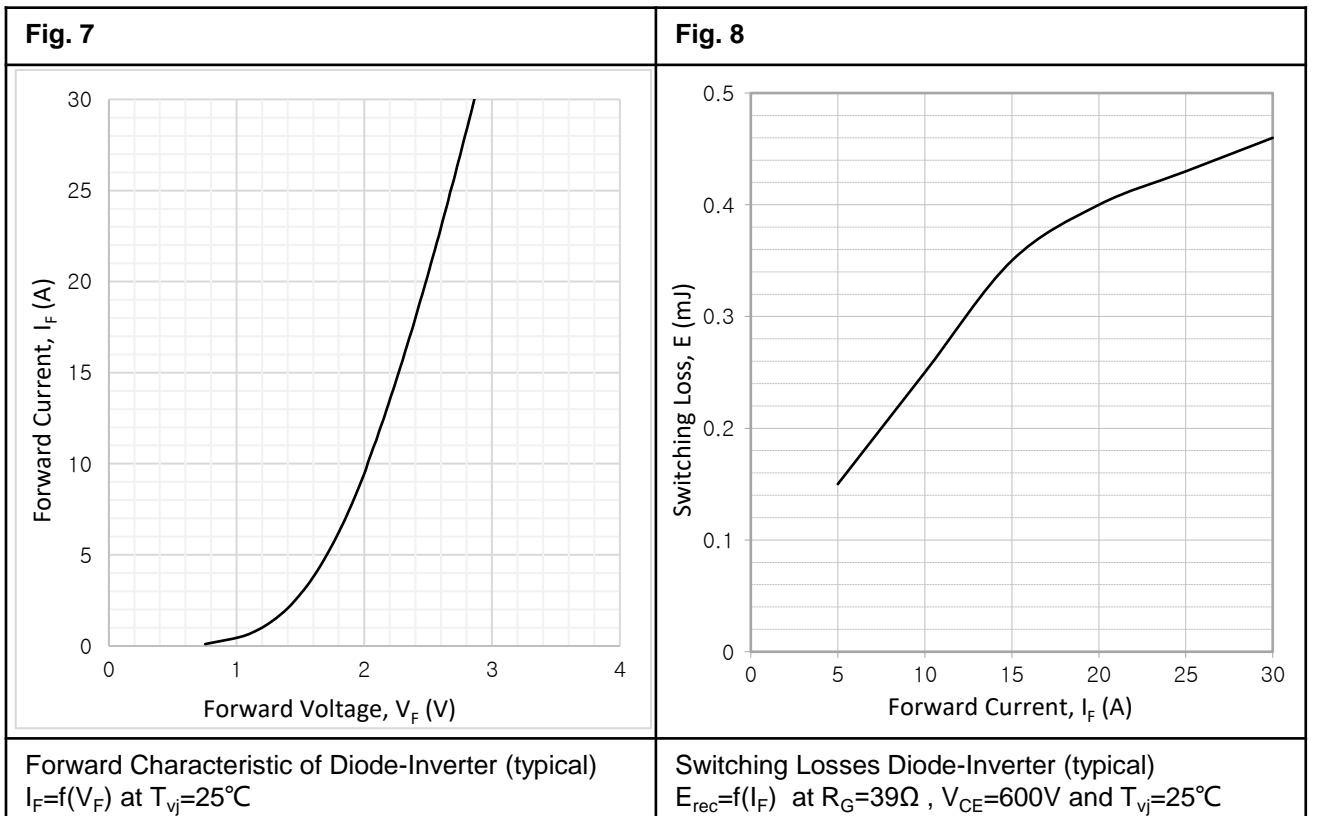
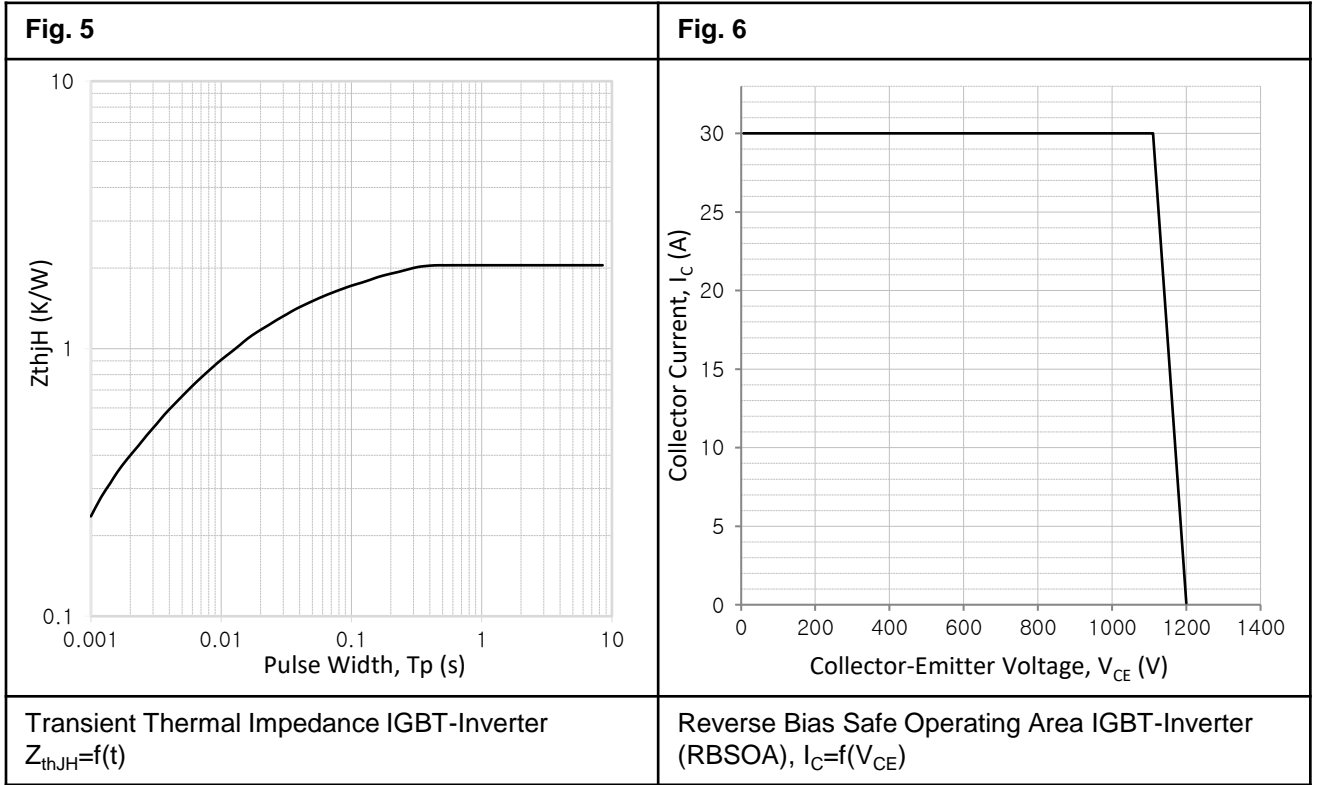

Typical Characteristics

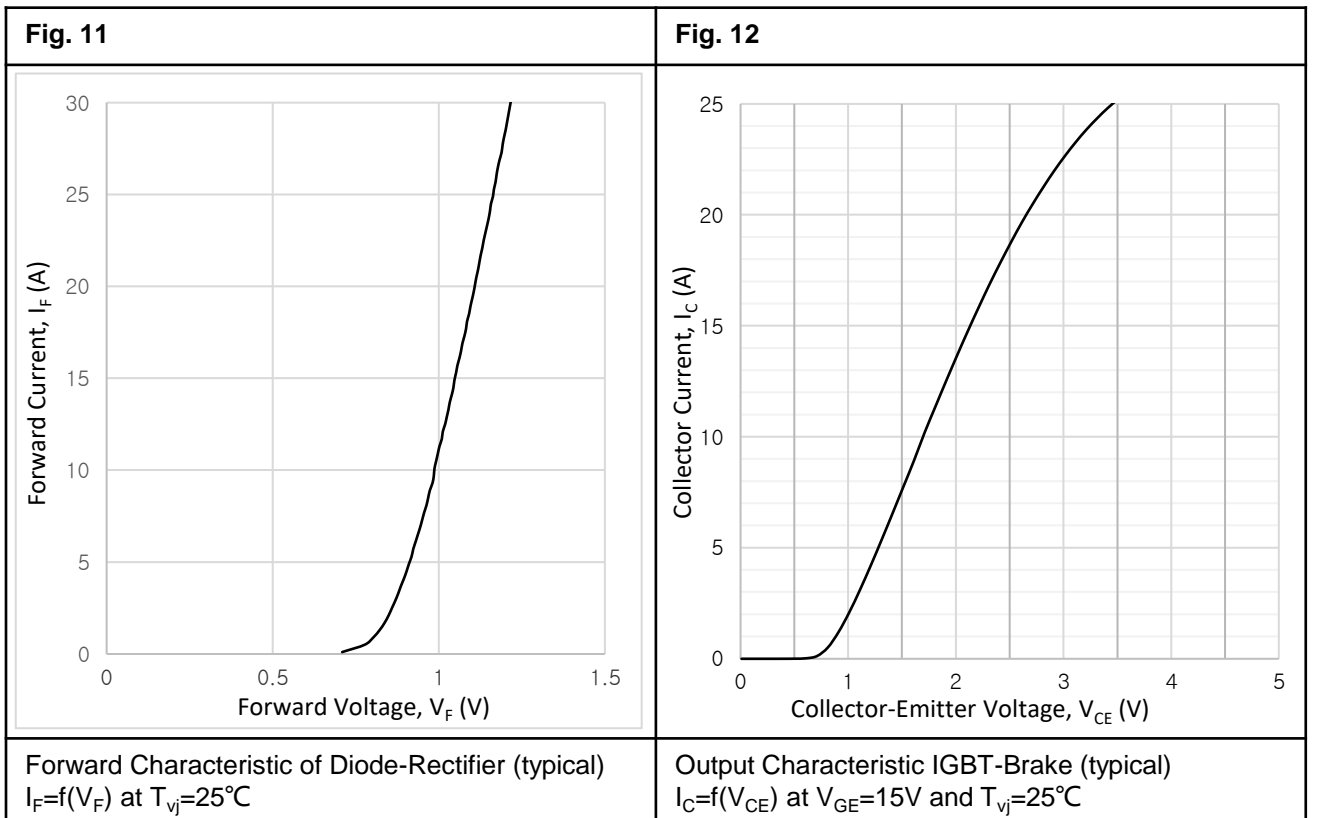
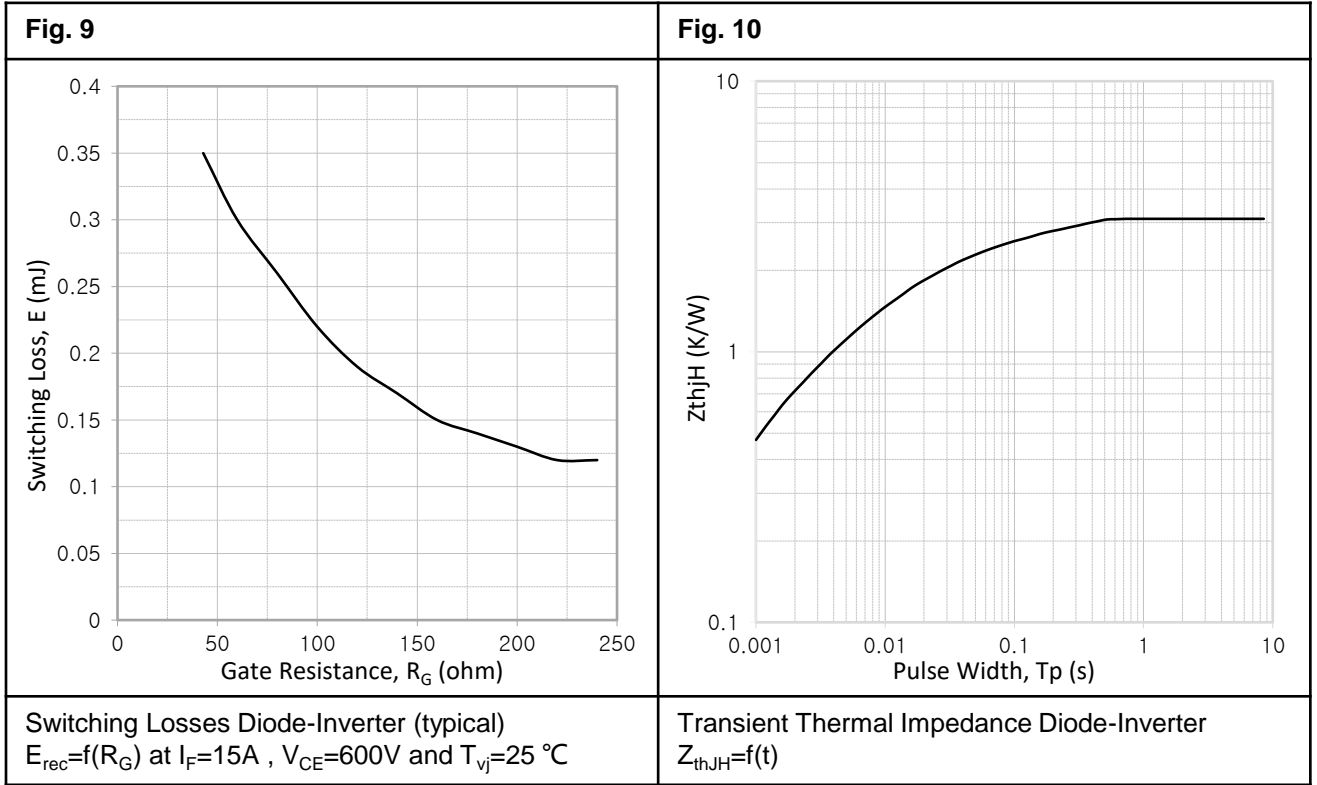

Typical Characteristics

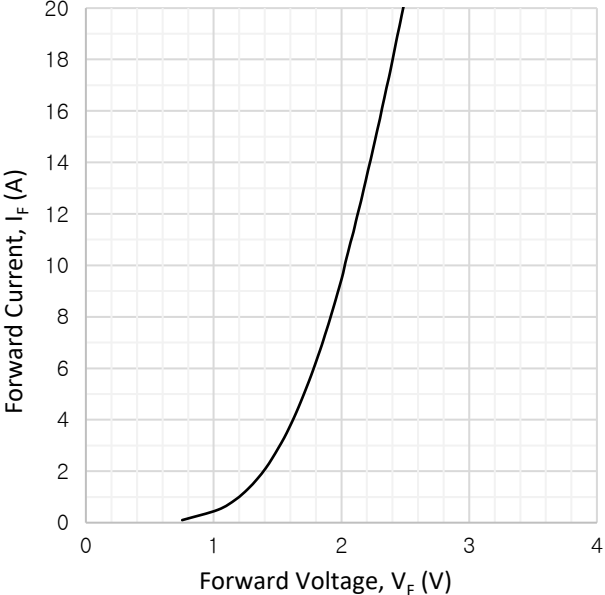
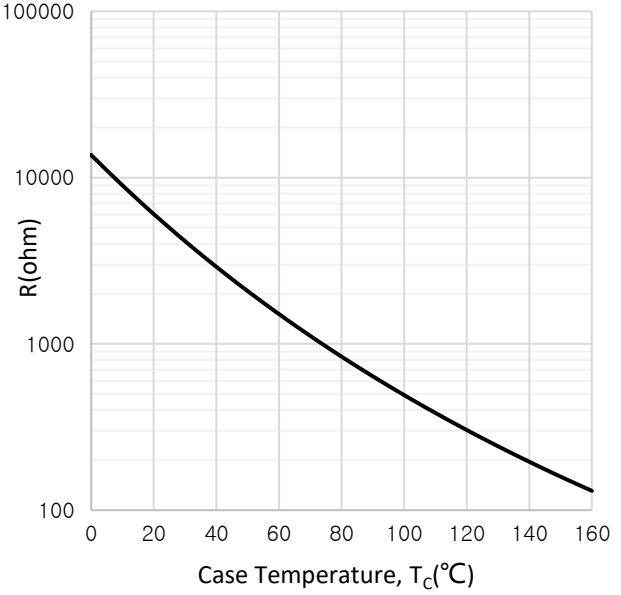
<p>Fig. 13</p>  <p>Forward Current, I_F (A)</p> <p>Forward Voltage, V_F (V)</p>	<p>Fig. 14</p>  <p>R (ohm)</p> <p>Case Temperature, T_C (°C)</p>
<p>Forward Characteristic of Diode-Brake (typical) $I_F=f(V_F)$ at $T_{vj}=25\text{ °C}$</p>	<p>NTC-Thermistor-Temperature Characteristic (typical), $R=f(T)$</p>

Circuit Diagram

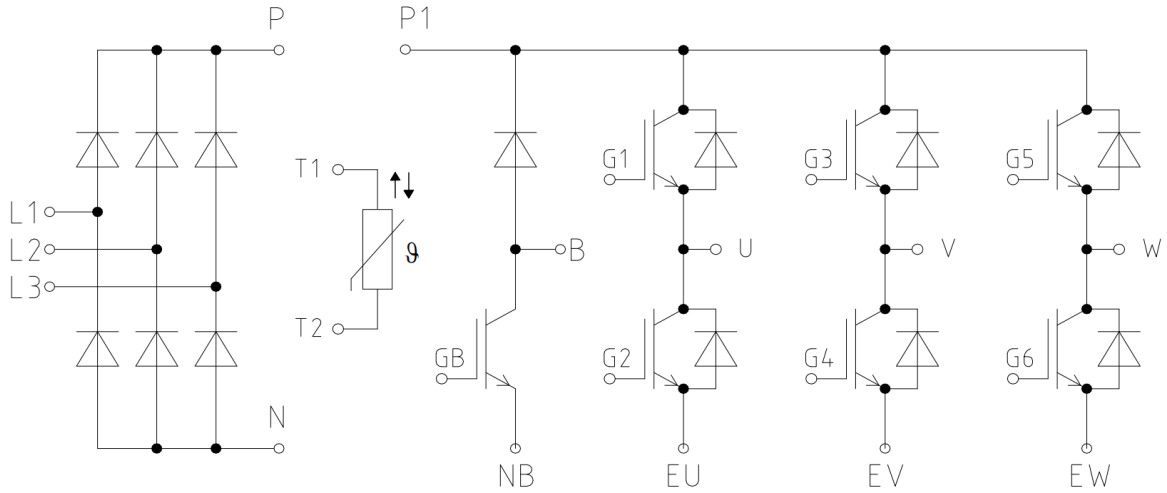

Package Outlines (mm)

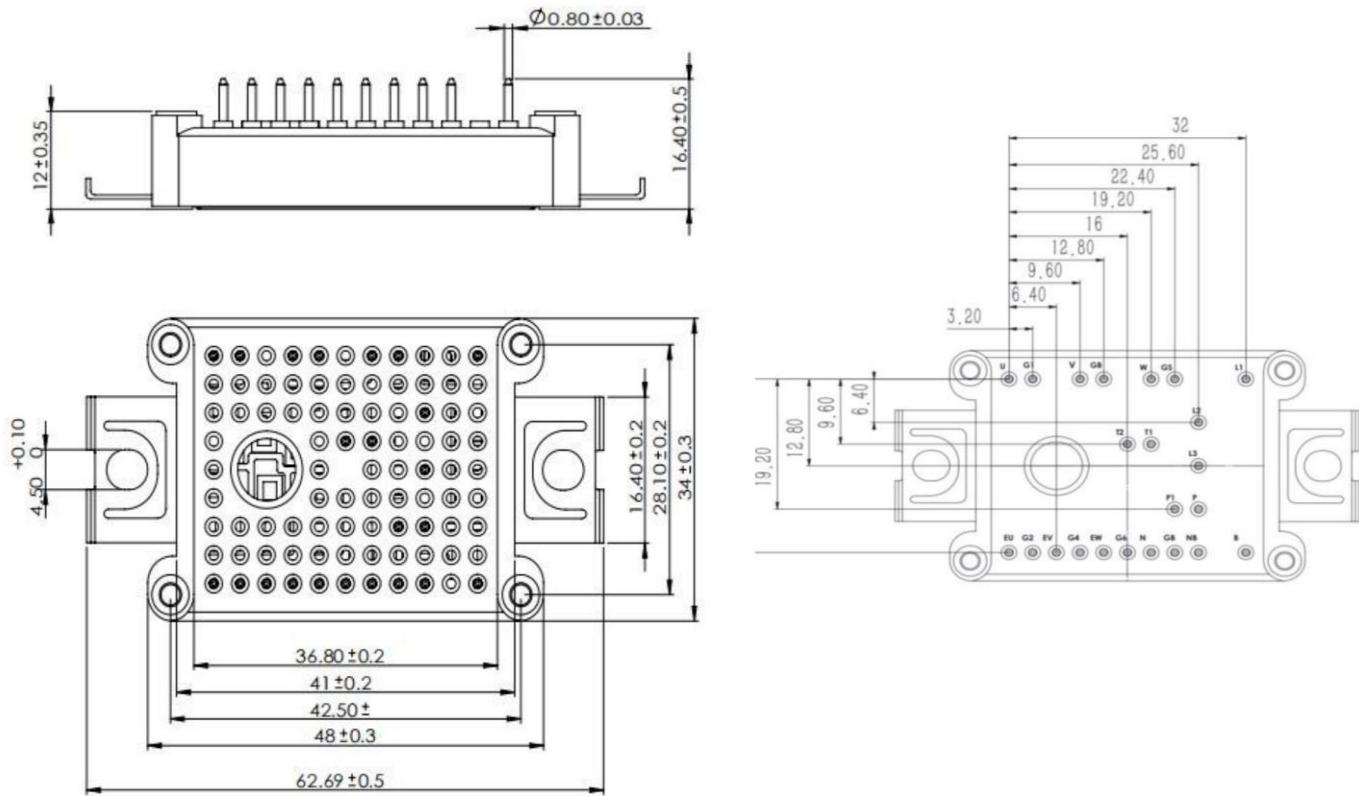

Revision History

Ver.	Date	Change Notice
1.0	2020/11/10	Released
1.1	2021/03/30	Released

X-ON Electronics

Largest Supplier of Electrical and Electronic Components

Click to view similar products for [IGBT Transistors](#) category:

Click to view products by [XDM](#) manufacturer:

Other Similar products are found below :

[748152A](#) [APT20GT60BRDQ1G](#) [IGW40N60H3FKSA1](#) [STGFW20V60DF](#) [APT45GR65B2DU30](#) [GT50JR22\(STA1ES\)](#) [TIG058E8-TL-H](#)
[RJH60F3DPQ-A0#T0](#) [APT40GR120B2SCD10](#) [NGTB75N65FL2WAG](#) [NGTG15N120FL2WG](#) [NTE3320](#) [IHF40N65R5SXKSA1](#)
[IKFW75N65ES5XKSA1](#) [IKFW50N65ES5XKSA1](#) [IKFW50N65EH5XKSA1](#) [IKFW40N65ES5XKSA1](#) [IKFW60N65ES5XKSA1](#)
[IMBG120R090M1HXTMA1](#) [IMBG120R140M1HXTMA1](#) [IGW30N60H3FKSA1](#) [STGWA8M120DF3](#) [IGW08T120FKSA1](#)
[IGB30N60H3ATMA1](#) [IGW100N60H3FKSA1](#) [IGW75N60H3FKSA1](#) [GT30N135SRA,S1E](#) [NCEP0160AG](#) [IXGK50N60B](#) [NRND](#)
[FGH60N60SMD_F085](#) [NGB8206ANSL3G](#) [IKW20N60H3FKSA1](#) [IKP30N65H5XKSA1](#) [IHW20N120R5XKSA1](#) [IGA03N120H2XKSA1](#)
[IKW25N120T2FKSA1](#) [IKW15T120FKSA1](#) [IKP20N60TXKSA1](#) [IHW40N65R5XKSA1](#) [IHW20N65R5XKSA1](#) [IGW25T120FKSA1](#)
[APT15GT60BRDQ1G](#) [APT35GP120J](#) [APT44GA60BD30](#) [STGWT60H65FB](#) [STGWT60H65DFB](#) [STGWT40V60DF](#) [STGWT20V60DF](#)
[FGH40T70SHD-F155](#) [FGD3245G2_F085](#)