

# RoHS

REV	ECN NO.	DESCRIPTION	DESIGN	APPROVAL	DATE
A1	NEW	更换图框			2023.11.25

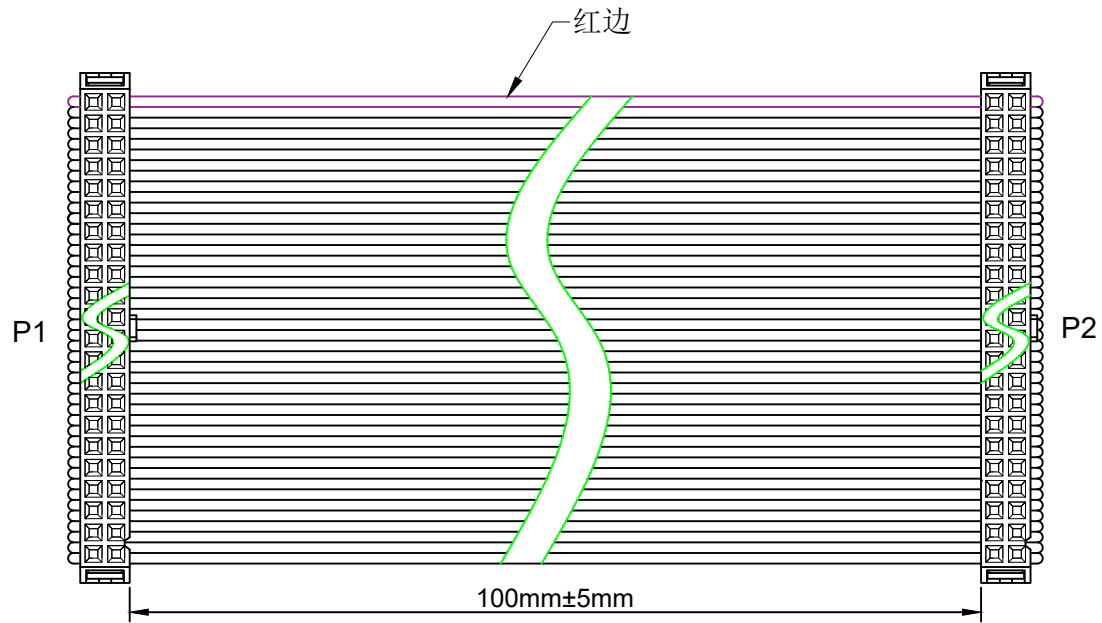

\*MATERIAL (IDC)  
 INSULATOR:PBT(UL 94V-0)  
 Contact:Copper Alloy.  
 Contact Plated:Gold or Tin over Nickel Plated.  
 \*SPECIFICATIONS  
 TEMPERATURE RANGE:-20°C TO-105° C  
 CONTACT RESISTANCE:3Ω MAX.  
 INSULATION RESISTANCE:5MΩ MIN.  
 WITHSTANDING VOLTAGE:300V 10S

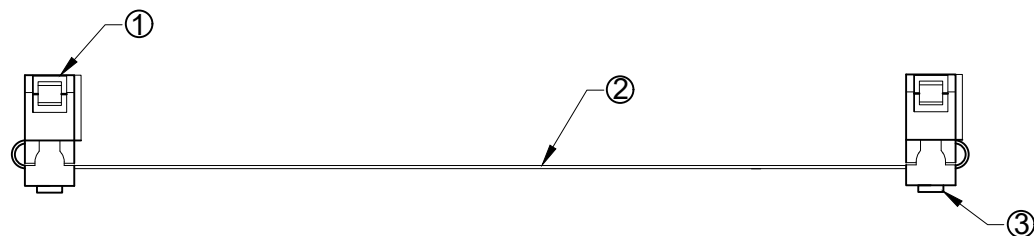

序号	名称	规格描述	数量
①	插头	IDC-50P 三件式 (2.0mm)	2
②	电线	UL2651 28AWG 1.0间距灰排 7/0.127TS	50P
③	卡扣	一个凸点朝外, 一个凸点朝内同向50P (2.0mm)	2

X.±0.50	X.°±
.X±0.25	.X°±
.XX±0.15	.xx°±
.XXX±0.10	.xxx°±
UNITS:	mm

THESE DRAWINGS AND SPECIFICATIONS ARE THE PROPERTY OF XFCN AND SHALL NOT BE REPRODUCED, COPIED OR CUED IN ANY MANNER WITHOUT THE PRIOR WRITTEN CONSENT OF XFCN

PART NO: CL2002350100BC10E		<b>XFCN</b> 兴飞连接器		
TITLE: 灰排线两端IDC2.0/50P 三件式 L=100mm 不含插头		0769-82001899		
		www.xfconn.com		
		DWG NO: /		
APPD		VIEW		
CHKD		SCALE	SHEET	REV
DRAW	Wang	NONE	1:1	A1
DATE	2023.11.25			

## X-ON Electronics

Largest Supplier of Electrical and Electronic Components

*Click to view similar products for [FFC / FPC Jumper Cables](#) category:*

*Click to view products by [XFCN](#) manufacturer:*

Other Similar products are found below :

[8-1474659-7](#) [FSK-21.5A-20](#) [FSK-23A](#) [FSN-14.5A-6](#) [1474494-5](#) [1557385-1](#) [2-1437211-4](#) [2-6447164-4](#) [1-6437133-3](#) [FSK-21A](#) [FSN-21.5A-32](#) [FSN-24A](#) [2-1437181-9](#) [4-1437186-9](#) [4-1474659-8](#) [5-1474654-9](#) [6-6437158-0](#) [1474544-1](#) [7-6474640-3](#) [8-1474644-8](#) [FSK-22Z-12](#) [1437190-1](#) [2-6437158-6](#) [3-1437213-7](#) [FSK-11.25A-40](#) [FSN-11A-10](#) [FSP-22A](#) [FST-41B-5](#) [1-1437203-7](#) [6447164-6](#) [1474678-7](#) [3-1437219-8](#) [FSK-11.1A-40](#) [FSN-11.5A-3](#) [1437219-2](#) [05-001-152FB](#) [05-001.5-152FB](#) [7-1437166-1](#) [5-1474677-4](#) [3-1447175-2](#) [4-6447189-2](#) [15020-1538](#) [FSK-21.3A-25](#) [07-004.5-172-P](#) [JS05B-12P-030-3-4](#) [JS05A-16P-080-4-8](#) [JS05A-12P-050-3-4](#) [JS05A-16P-100-3-4](#) [JS05A-12P-100-3-4](#) [JS05A-12P-030-3-4](#)