

环保物料

TEL:0769-82001899

| NO. | PART       | MATERIAL        | COATING/COLOR | QTY |
|-----|------------|-----------------|---------------|-----|
| 1   | HOUSING    | LCP UL94V-0     | BEIGE         | 1   |
| 2   | TERMINALS  | PHOSPHOR BRONZE | PLATING GOLD  | N   |
| 3   | REAR COVER | LCP UL94V-0     | BLACK         | 1   |
| 4   | SOLDER TAB | BRASS           | PLATING TIN   | 2   |

**NOTE:**  
 1 TECHNICAL PARAMETER:  
 1.1 RATINGS: 0.5A/50V (DC AC)  
 1.2 CONTACT RESISTANCE: 30MΩ MAX.  
 1.3 INSULATION RESISTANCE: 100MΩ MIN  
 1.4 WITHSTAND VOLTAGE: 500V AC/MINUTE  
 1.5 WORKING TEMPERATURE: -40°C ~ +105°C  
 PART NO: F0502-ZV-xx-59G-R

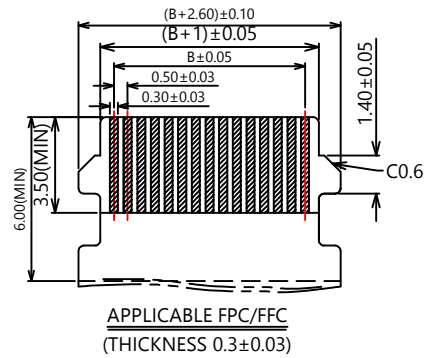
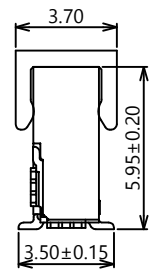
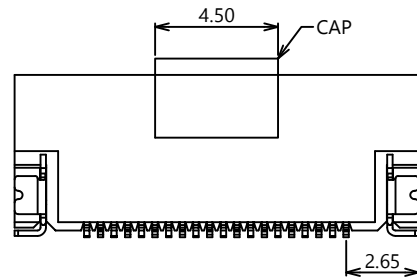
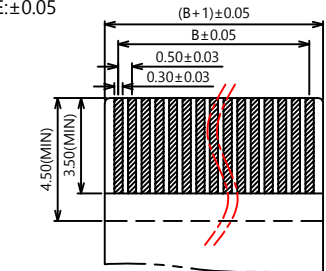
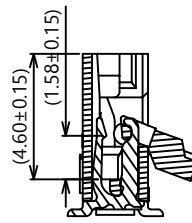
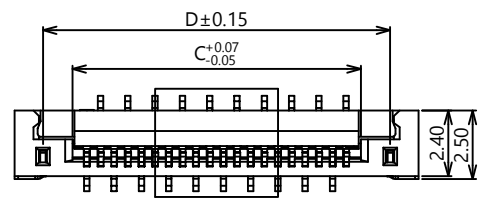
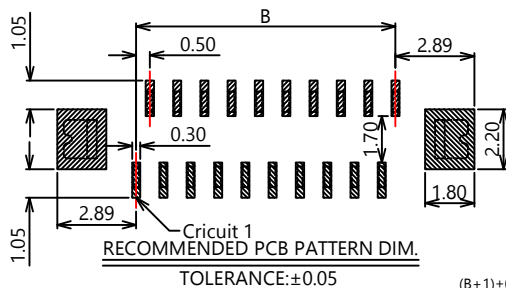
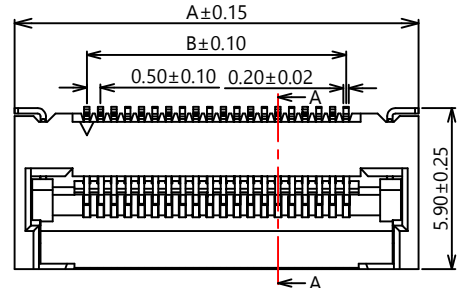

XX表示PIN数

| PIN | A     | B     | C     | D     |
|-----|-------|-------|-------|-------|
| 4   | 6.80  | 1.50  | 2.57  | 4.72  |
| 5   | 7.30  | 2.00  | 3.07  | 5.22  |
| 6   | 7.80  | 2.50  | 3.57  | 5.72  |
| 7   | 8.30  | 3.00  | 4.07  | 6.22  |
| 8   | 8.80  | 3.50  | 4.57  | 6.72  |
| 9   | 9.30  | 4.00  | 5.07  | 7.22  |
| 10  | 9.80  | 4.50  | 5.57  | 7.72  |
| 11  | 10.30 | 5.00  | 6.07  | 8.22  |
| 12  | 10.80 | 5.50  | 6.57  | 8.72  |
| 13  | 11.30 | 6.00  | 7.07  | 9.22  |
| 14  | 11.80 | 6.50  | 7.57  | 9.72  |
| 15  | 12.30 | 7.00  | 8.07  | 10.22 |
| 16  | 12.80 | 7.50  | 8.57  | 10.72 |
| 17  | 13.30 | 8.00  | 9.07  | 11.22 |
| 18  | 13.80 | 8.50  | 9.57  | 11.72 |
| 19  | 14.30 | 9.00  | 10.07 | 12.22 |
| 20  | 14.80 | 9.50  | 10.57 | 12.72 |
| 21  | 15.30 | 10.00 | 11.07 | 13.22 |
| 22  | 15.80 | 10.50 | 11.57 | 13.72 |
| 23  | 16.30 | 11.00 | 12.07 | 14.22 |
| 24  | 16.80 | 11.50 | 12.57 | 14.72 |
| 25  | 17.30 | 12.00 | 13.07 | 15.22 |
| 26  | 17.80 | 12.50 | 13.57 | 15.72 |
| 27  | 18.30 | 13.00 | 14.07 | 16.22 |
| 28  | 18.80 | 13.50 | 14.57 | 16.72 |
| 29  | 19.30 | 14.00 | 15.07 | 17.22 |
| 30  | 19.80 | 14.50 | 15.57 | 17.72 |
| ~   | ~     | ~     | ~     | ~     |
| 61  | 35.30 | 30.00 | 31.07 | 33.22 |

| AO  | MODIFICATION | DRAW | DATE |
|-----|--------------|------|------|
| VER |              |      |      |

| TOLERANCE UNLESS OTHERWISE                                | DRAWN | CK | tan |
|---|-------|----|-----|
| <b>TOLERANCE :</b><br>.000 ±0.08<br>.00 ±0.13<br>.0 ±0.25 | CHKD  |    |     |
|   | APPD  |    |     |
|   | VIEW  | ⊕  | ∇   |

**XFCN** 兴飞连接器有限公司  
 XFCN CONNECTORS CO.,LTD.

PRODUCT NAME: FPC CONNECTORS  
 PART. NO.: F0502-ZV-xx-59G-R

| SHEET    | 1/1          |
|----------|--------------|
| DATE     | 2020. 04. 12 |
| UNITS    | mm           |
| SCALE    | 1:1          |
| DWG. NO. | 009          |

## X-ON Electronics

Largest Supplier of Electrical and Electronic Components

*Click to view similar products for [FFC & FPC Connectors](#) category:*

*Click to view products by [XFCN](#) manufacturer:*

Other Similar products are found below :

[00-6200-227-022-800](#) [006205250500825+](#) [006205280500825+](#) [FPH-1602G](#) [086222026001800](#) [52610-0675](#) [62674-201121DLF](#) [52746-1671-TR250](#) [10051922-1610EHLF](#) [10051922-2810EHLF](#) [686322124422](#) [XF3M-2915-1B-R100](#) [AYF353125A](#) [AYF530665TA](#) [AYF534065TA](#) [20FLH-RSM1-TB](#) [207356-1](#) [SFW12R-5STE9LF](#) [SFW18R-1STAE9LF](#) [SFW4R-5STE9LF](#) [52807-0430](#) [046283021002868+](#) [FFC05011-10SBB114W5M](#) [502250-8027](#) [67000-008LF](#) [200528-0260](#) [FH28K-10S-0.5SH](#) [FH52K-6S-0.5SH](#) [0.5K-DX-30PWB](#) [DS1020-08-10VBT12](#) [THD0515-34CL-GF](#) [X05A10L28G](#) [ECC2841061EU](#) [1.0K-DHQX-16PWB](#) [1.0K-DHQX-30PWB](#) [1775333-6](#) [10054365-202110ELF](#) [10054365-242110ELF](#) [10054365-282110ELF](#) [10064555-392220HLF](#) [59453-041110EBHLF](#) [59453-091110EDHLF](#) [62674-241141ALF](#) [62684-432100ALF](#) [62684-451100AHLF](#) [62684-5721N0ALF](#) [HFW11R-1STE1MTLF](#) [HFW12R-1STE9LF](#) [HFW14R-1STE9MTLF](#) [HFW18S-2STE9LF](#)