

环保物料

TEL:0769-82001899

NO.	PART	MATERIAL	COATING/COLOR	QTY
1	HOUSING	LCP UL94V-0	BEIGE	1
2	TERMINALS	PHOSPHOR BRONZE	PLATING GOLD	N
3	REAR COVER	LCP UL94V-0	BLACK	1
4	SOLDER TAB	BRASS	PLATING TIN	2

NOTE:
 1 TECHNICAL PARAMETER:
 1.1 RATINGS: 0.5A/50V (DC AC)
 1.2 CONTACT RESISTANCE: 30MΩ MAX.
 1.3 INSULATION RESISTANCE: 100MΩ MIN
 1.4 WITHSTAND VOLTAGE: 500V AC/MINUTE
 1.5 WORKING TEMPERATURE: -40°C ~ +105°C
 PART NO: F0502-ZV-xx-59G-R

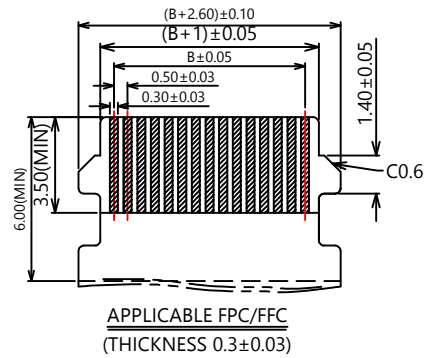
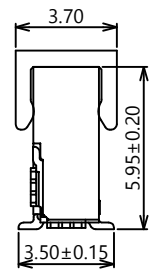
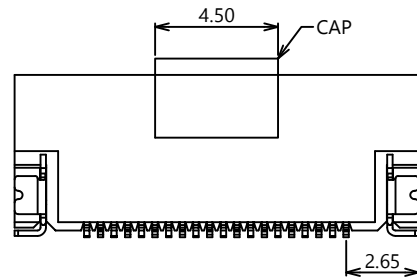
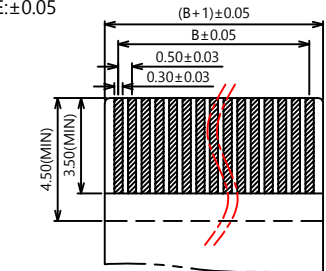
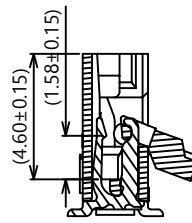
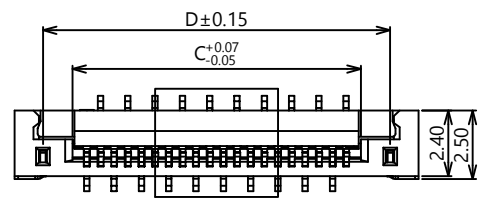
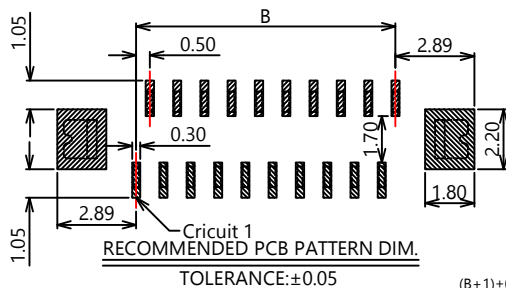
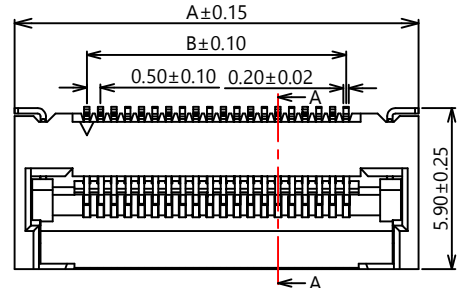

XX表示PIN数

PIN	A	B	C	D
4	6.80	1.50	2.57	4.72
5	7.30	2.00	3.07	5.22
6	7.80	2.50	3.57	5.72
7	8.30	3.00	4.07	6.22
8	8.80	3.50	4.57	6.72
9	9.30	4.00	5.07	7.22
10	9.80	4.50	5.57	7.72
11	10.30	5.00	6.07	8.22
12	10.80	5.50	6.57	8.72
13	11.30	6.00	7.07	9.22
14	11.80	6.50	7.57	9.72
15	12.30	7.00	8.07	10.22
16	12.80	7.50	8.57	10.72
17	13.30	8.00	9.07	11.22
18	13.80	8.50	9.57	11.72
19	14.30	9.00	10.07	12.22
20	14.80	9.50	10.57	12.72
21	15.30	10.00	11.07	13.22
22	15.80	10.50	11.57	13.72
23	16.30	11.00	12.07	14.22
24	16.80	11.50	12.57	14.72
25	17.30	12.00	13.07	15.22
26	17.80	12.50	13.57	15.72
27	18.30	13.00	14.07	16.22
28	18.80	13.50	14.57	16.72
29	19.30	14.00	15.07	17.22
30	19.80	14.50	15.57	17.72
~	~	~	~	~
61	35.30	30.00	31.07	33.22

AO	MODIFICATION	DRAW	DATE
VER			

TOLERANCE UNLESS OTHERWISE	DRAWN	CK	tan
TOLERANCE : .000 ±0.08 .00 ±0.13 .0 ±0.25	CHKD		
	APPD		
	VIEW	⊕	⊖

XFCN 兴飞连接器有限公司
 XFCN CONNECTORS CO.,LTD.

PRODUCT NAME: FPC CONNECTORS
 PART. NO.: F0502-ZV-xx-59G-R

SHEET	1/1
DATE	2020. 04. 12
UNITS	mm
SCALE	1:1
DWG. NO.	009

X-ON Electronics

Largest Supplier of Electrical and Electronic Components

Click to view similar products for [FFC & FPC Connectors](#) category:

Click to view products by [XFCN](#) manufacturer:

Other Similar products are found below :

[00-6200-227-022-800](#) [006205250500825+](#) [006205280500825+](#) [FPH-1602G](#) [086222026001800](#) [52610-0675](#) [62674-201121DLF](#) [52746-1671-TR250](#) [10051922-1610EHLF](#) [10051922-2810EHLF](#) [686322124422](#) [XF3M-2915-1B-R100](#) [AYF353125A](#) [AYF530665TA](#) [AYF534065TA](#) [20FLH-RSM1-TB](#) [207356-1](#) [SFW12R-5STE9LF](#) [SFW18R-1STAE9LF](#) [SFW4R-5STE9LF](#) [52807-0430](#) [046283021002868+](#) [FFC05011-10SBB114W5M](#) [502250-8027](#) [67000-008LF](#) [200528-0260](#) [FH28K-10S-0.5SH](#) [FH52K-6S-0.5SH](#) [0.5K-DX-30PWB](#) [DS1020-08-10VBT12](#) [THD0515-34CL-GF](#) [X05A10L28G](#) [ECC2841061EU](#) [1.0K-DHQX-16PWB](#) [1.0K-DHQX-30PWB](#) [1775333-6](#) [10054365-202110ELF](#) [10054365-242110ELF](#) [10054365-282110ELF](#) [10064555-392220HLF](#) [59453-041110EBHLF](#) [59453-091110EDHLF](#) [62674-241141ALF](#) [62684-432100ALF](#) [62684-451100AHLF](#) [62684-5721N0ALF](#) [HFW11R-1STE1MTLF](#) [HFW12R-1STE9LF](#) [HFW14R-1STE9MTLF](#) [HFW18S-2STE9LF](#)