

环保物料

TEL: 0769-82001899

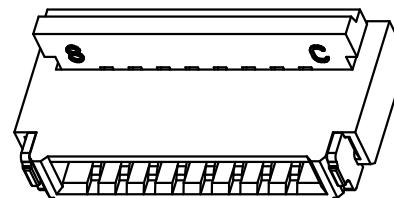
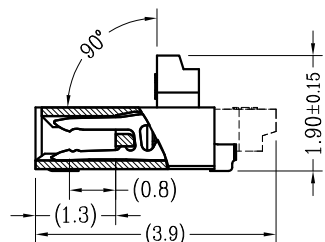
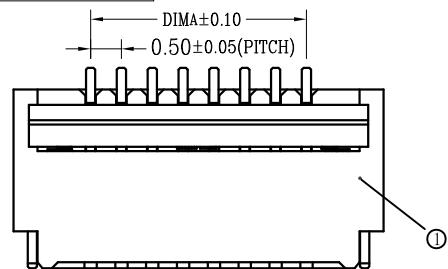

技术指标:

1. 塑件表面应光洁、无毛边、无明显收缩、缺陷、裂纹等现象.
2. 温度范围: $-25^{\circ}\text{C} \sim 85^{\circ}\text{C}$.
3. 额定电压: 50V, AC/DC(等效).
4. 接触电阻: $\leq 0.03\Omega$.
5. 绝缘电阻: $\geq 500\text{M}\Omega$

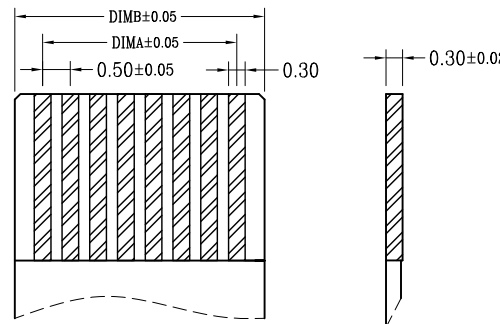
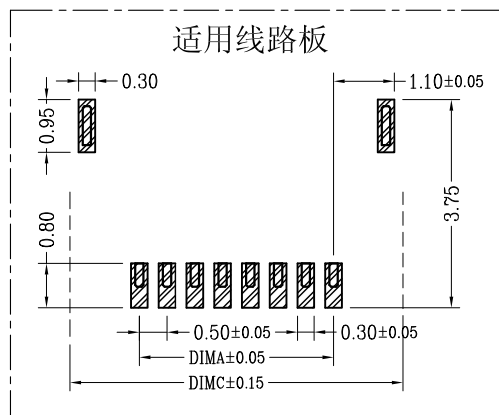
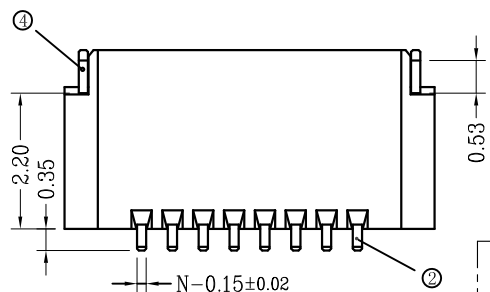
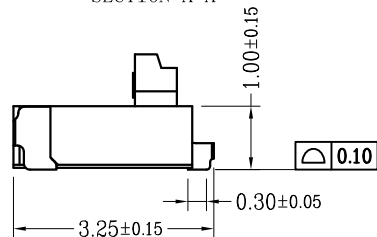
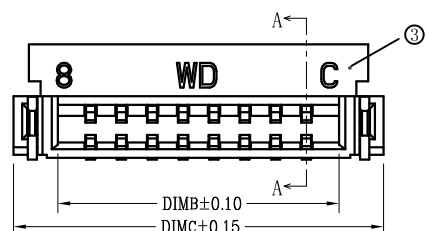

CKT	DIMA	DIMB	DIMC	CKT	DIMA	DIMB	DIMC
4	1.50	2.56	4.00	23	11.00	12.06	13.50
5	2.00	3.06	4.50	24	11.50	12.56	14.00
6	2.50	3.56	5.00	25	12.00	13.06	14.50
7	3.00	4.06	5.50	26	12.50	13.56	15.00
8	3.50	4.56	6.00	27	13.00	14.06	15.50
9	4.00	5.06	6.50	28	13.50	14.56	16.00
10	4.50	5.56	7.00	29	14.00	15.06	16.50
11	5.00	6.06	7.50	30	14.50	15.56	17.00
12	5.50	6.56	8.00	31	15.00	16.06	17.50
13	6.00	7.06	8.50	32	15.50	16.56	18.00
14	6.50	7.56	9.00	33	16.00	17.06	18.50
15	7.00	8.06	9.50	34	16.50	17.56	19.00
16	7.50	8.56	10.00	35	17.00	18.06	19.50
17	8.00	9.06	10.50	36	17.50	18.56	20.00
18	8.50	9.56	11.00	37	18.00	19.06	20.50
19	9.00	10.06	11.50	38	18.50	19.56	21.00
20	9.50	10.56	12.00	39	19.00	20.06	21.50
21	10.00	11.06	12.50	40	19.50	20.56	22.00
22	10.50	11.56	13.00				

序号	品名	材质
①	0.5后压卧式胶芯 (H1.0)	LCP UL94V-0 本色
②	0.5后压卧式端子 (H1.0)	磷青铜/表面镀金
③	0.5后压卧式后盖 (H1.0)	LCP UL94V-0 黑色
④	0.5后压卧式焊片 (H1.0)	磷青铜/表面镀锡

AO	MODIFICATION	DRAW	DATE
VER			

TOLERANCE UNLESS OTHERWISE			
X.	±0.30	X°	±5°
.X	±0.20	.X°	±2°
.XX	±0.08	.XX°	±1°
.XXX	±0.03	.XXX°	±0.5°

DRAWN	CK tan
CHKD	
APPD	
VIEW	

XFCN 兴飞连接器有限公司
XFCN CONNECTORS CO.,LTD.

PRODUCT NAME 0.50mm FPC Connectors

PART. NO. F0504-H-xx-10G-R

SHEET	1/1
DATE	2020.04.12
UNITS	mm
SCALE	1:1
DWG. NO.	009

X-ON Electronics

Largest Supplier of Electrical and Electronic Components

Click to view similar products for [FFC & FPC Connectors](#) category:

Click to view products by [XFCN](#) manufacturer:

Other Similar products are found below :

[00-6200-227-022-800](#) [006205250500825+](#) [006205280500825+](#) [FPH-1602G](#) [FPH-2022G](#) [52610-1275](#) [501864-3091-TR225](#)
[086222026001800](#) [52610-0675](#) [62674-201121DLF](#) [62684-36210E9ALF](#) [52746-1671-TR250](#) [10051922-2810EHLF](#) [686322124422](#) [XF3M-](#)
[2915-1B-R100](#) [AYF353125A](#) [AYF530665TA](#) [AYF534065TA](#) [AYF351525](#) [086212040340800+](#) [AYF530365TA](#) [67000-004LF](#)
[006207341915000+](#) [207356-1](#) [67000-003LF](#) [HFW14R-2STE9LF](#) [SFW12R-5STE9LF](#) [SFW18R-1STAE9LF](#) [SFW4R-5STE9LF](#) [52807-0430](#)
[046283021002868+](#) [502250-8027](#) [104267-9617](#) [66987-011LF](#) [HFW8S-2STAE1HLF](#) [67000-008LF](#) [HFW22R-2STE1H1LF](#) [0781271110](#)
[5019511030](#) [200528-0260](#) [5039084120](#) [503908-5120](#) [SFW20R-1STGE5LF](#) [FH12-18S-0.5SH](#) [686116183522](#) [FH64MA-11S-0.25SHW](#)
[686114183522](#) [502078-5362](#) [FH52K-68S-0.5SH](#) [FH26W-23S-0.3SHW\(60\)](#)